

### FEATURES

#### Superior Performance

High Unity Gain BW: 50 MHz

Low Supply Current: 5.3 mA

High Slew Rate: 300 V/ $\mu$ s

#### Excellent Video Specifications

0.04% Differential Gain (NTSC and PAL)

0.19° Differential Phase (NTSC and PAL)

Drives Any Capacitive Load

Fast Settling Time to 0.1% (10 V Step): 65 ns

#### Excellent DC Performance

High Open-Loop Gain 5.5 V/mV ( $R_{LOAD} = 1\text{ k}\Omega$ )

Low Input Offset Voltage: 0.5 mV

Specified for  $\pm 5\text{ V}$  and  $\pm 15\text{ V}$  Operation

Available in a Wide Variety of Options

Plastic DIP and SOIC Packages

Cerdip Package

Die Form

MIL-STD-883B Processing

Tape & Reel (EIA-481A Standard)

Dual Version Available: AD827 (8 Lead)

Enhanced Replacement for LM6361

Replacement for HA2544, HA2520/2/5 and EL2020

### APPLICATIONS

Video Instrumentation

Imaging Equipment

Copiers, Fax, Scanners, Cameras

High Speed Cable Driver

High Speed DAC and Flash ADC Buffers

### PRODUCT DESCRIPTION

The AD847 represents a breakthrough in high speed amplifiers offering superior ac & dc performance and low power, all at low cost. The excellent dc performance is demonstrated by its  $\pm 5\text{ V}$



Quiescent Current vs. Supply Voltage

### REV. F

Information furnished by Analog Devices is believed to be accurate and reliable. However, no responsibility is assumed by Analog Devices for its use, nor for any infringements of patents or other rights of third parties which may result from its use. No license is granted by implication or otherwise under any patent or patent rights of Analog Devices.

### CONNECTION DIAGRAM

Plastic DIP (N),  
Small Outline (R) and  
Cerdip (Q) Packages

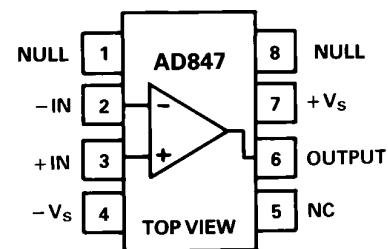

NC = NO CONNECT

specifications which include an open-loop gain of 3500 V/V (500  $\Omega$  load) and low input offset voltage of 0.5 mV. Common-mode rejection is a minimum of 78 dB. Output voltage swing is  $\pm 3\text{ V}$  into loads as low as 150  $\Omega$ . Analog Devices also offers over 30 other high speed amplifiers from the low noise AD829 (1.7 nV/ $\sqrt{\text{Hz}}$ ) to the ultimate video amplifier, the AD811, which features 0.01% differential gain and 0.01° differential phase.

### APPLICATION HIGHLIGHTS

1. As a buffer the AD847 offers a full-power bandwidth of 12.7 MHz (5 V p-p with  $\pm 5\text{ V}$  supplies) making it outstanding as an input buffer for flash A/D converters.
2. The low power and small outline package of the AD847 make it very well suited for high density applications such as multiple pole active filters.
3. The AD847 is internally compensated for unity gain operation and remains stable when driving any capacitive load.



AD847 Driving Capacitive Loads

# AD847–SPECIFICATIONS (@ T<sub>A</sub> = +25°C, unless otherwise noted)

Model	Conditions	V <sub>S</sub>	AD847J			AD847AR			Units
			Min	Typ	Max	Min	Typ	Max	
INPUT OFFSET VOLTAGE <sup>1</sup>		±5 V		0.5	<b>1</b>		0.5	<b>1</b>	mV
Offset Drift	T <sub>MIN</sub> to T <sub>MAX</sub>			15	3.5		15	4	mV μV/°C
INPUT BIAS CURRENT		±5 V, ±15 V		3.3	<b>6.6</b>		3.3	<b>6.6</b>	μA μA
	T <sub>MIN</sub> to T <sub>MAX</sub>				7.2			10	
INPUT OFFSET CURRENT		±5 V, ±15 V		50	<b>300</b>		<b>50</b>	<b>300</b>	nA nA
Offset Current Drift	T <sub>MIN</sub> to T <sub>MAX</sub>			0.3	400		0.3	500	nA/°C
OPEN-LOOP GAIN	V <sub>OUT</sub> = ±2.5 V R <sub>LOAD</sub> = 500 Ω T <sub>MIN</sub> to T <sub>MAX</sub>	±5 V	<b>2</b>	3.5		<b>2</b>	3.5		V/mV V/mV
	R <sub>LOAD</sub> = 150 Ω		1	1.6		1	1.6		V/mV
	V <sub>OUT</sub> = ±10 V R <sub>LOAD</sub> = 1 kΩ T <sub>MIN</sub> to T <sub>MAX</sub>	±15 V	<b>3</b>	5.5		<b>3</b>	5.5		V/mV V/mV
			1.5			1.5			
DYNAMIC PERFORMANCE									
Unity Gain Bandwidth		±5 V		35			35		MHz
		±15 V		50			50		MHz
Full Power Bandwidth <sup>2</sup>	V <sub>OUT</sub> = 5 V p-p R <sub>LOAD</sub> = 500 Ω	±5 V		12.7			12.7		MHz
	V <sub>OUT</sub> = 20 V p-p, R <sub>LOAD</sub> = 1 kΩ	±15 V		4.7			4.7		MHz
Slew Rate <sup>3</sup>	R <sub>LOAD</sub> = 1 kΩ	±5 V		200			200		V/μs
		±15 V	225	300		225	300		V/μs
Settling Time									
to 0.1%, R <sub>LOAD</sub> = 250 Ω	-2.5 V to +2.5 V 10 V Step, A <sub>V</sub> = -1	±5 V		65			65		ns
		±15 V		65			65		ns
to 0.01%, R <sub>LOAD</sub> = 250 Ω	-2.5 V to +2.5 V 10 V Step, A <sub>V</sub> = -1	±5 V		140			140		ns
		±15 V		120			120		ns
Phase Margin	C <sub>LOAD</sub> = 10 pF R <sub>LOAD</sub> = 1 kΩ	±15 V		50			50		Degree
Differential Gain	f ≈ 4.4 MHz, R <sub>LOAD</sub> = 1 kΩ	±15 V		0.04			0.04		%
Differential Phase	f ≈ 4.4 MHz, R <sub>LOAD</sub> = 1 kΩ	±15 V		0.19			0.19		Degree
COMMON-MODE REJECTION									
	V <sub>CM</sub> = ±2.5 V	±5 V	<b>78</b>	95		<b>78</b>	95		dB
	V <sub>CM</sub> = ±12 V	±15 V	<b>78</b>	95		<b>78</b>	95		dB
	T <sub>MIN</sub> to T <sub>MAX</sub>		75			75			dB
POWER SUPPLY REJECTION	V <sub>S</sub> = ±5 V to ±15 V T <sub>MIN</sub> to T <sub>MAX</sub>		<b>75</b>	86		<b>75</b>	86		dB dB
INPUT VOLTAGE NOISE	f = 10 kHz	±15 V		15			15		nV/√Hz
INPUT CURRENT NOISE	f = 10 kHz	±15 V		1.5			1.5		pA/√Hz
INPUT COMMON-MODE VOLTAGE RANGE		±5 V		+4.3			+4.3		V
		±15 V		-3.4			-3.4		V
				+14.3			+14.3		V
				-13.4			-13.4		V
OUTPUT VOLTAGE SWING									
	R <sub>LOAD</sub> = 500 Ω	±5 V	<b>3.0</b>	3.6		<b>3.0</b>	3.6		±V
	R <sub>LOAD</sub> = 150 Ω	±5 V	<b>2.5</b>	3		<b>2.5</b>	3		±V
	R <sub>LOAD</sub> = 1 kΩ	±15 V	<b>12</b>			<b>12</b>			±V
	R <sub>LOAD</sub> = 500 Ω	±15 V	<b>10</b>			<b>10</b>			±V
Short-Circuit Current		±15 V		32			32		mA
INPUT RESISTANCE				300			300		kΩ
INPUT CAPACITANCE				1.5			1.5		pF
OUTPUT RESISTANCE	Open Loop			15			15		Ω
POWER SUPPLY									
Operating Range			<b>±4.5</b>		<b>±18</b>	<b>±4.5</b>		<b>±18</b>	V
Quiescent Current	T <sub>MIN</sub> to T <sub>MAX</sub>	±5 V		4.8	<b>6.0</b>		4.8	<b>6.0</b>	mA
		±15 V		5.3	<b>6.3</b>		5.3	<b>6.3</b>	mA
	T <sub>MIN</sub> to T <sub>MAX</sub>				7.6			7.6	mA

## NOTES

<sup>1</sup>Input Offset Voltage Specifications are guaranteed after 5 minutes at T<sub>A</sub> = +25°C.

<sup>2</sup>Full Power Bandwidth = Slew Rate/2 π V<sub>PEAK</sub>.

<sup>3</sup>Slew Rate is measured on rising edge.

All min and max specifications are guaranteed. Specifications in **boldface** are 100% tested at final electrical test.

Specifications subject to change without notice.

Model	Conditions	V <sub>S</sub>	AD847AQ			AD847S			Units	
			Min	Typ	Max	Min	Typ	Max		
INPUT OFFSET VOLTAGE <sup>1</sup> Offset Drift	T <sub>MIN</sub> to T <sub>MAX</sub>	±5 V		0.5	<b>1</b>		0.5	<b>1</b>	mV mV μV/°C	
				15	<b>4</b>		15	<b>4</b>		
INPUT BIAS CURRENT	T <sub>MIN</sub> to T <sub>MAX</sub>	±5 V, ±15 V		3.3	<b>5</b> <b>7.5</b>		3.3	<b>5</b> <b>7.5</b>	μA μA	
INPUT OFFSET CURRENT Offset Current Drift	T <sub>MIN</sub> to T <sub>MAX</sub>	±5 V, ±15 V		50	<b>300</b> <b>400</b>		<b>50</b> <b>300</b> <b>400</b>	<b>300</b> <b>400</b>	nA nA nA/°C	
				0.3		0.3				
OPEN-LOOP GAIN	V <sub>OUT</sub> = ±2.5 V R <sub>LOAD</sub> = 500 Ω T <sub>MIN</sub> to T <sub>MAX</sub> R <sub>LOAD</sub> = 150 Ω V <sub>OUT</sub> = ±10 V R <sub>LOAD</sub> = 1 kΩ T <sub>MIN</sub> to T <sub>MAX</sub>	±5 V	<b>2</b>	3.5		<b>2</b>	3.5		V/mV V/mV	
			<b>1</b>	1.6		<b>1</b>	1.6			
		±15 V	<b>3</b>	5.5		<b>3</b>	5.5		V/mV V/mV	
			<b>1.5</b>			<b>1.5</b>				
DYNAMIC PERFORMANCE Unity Gain Bandwidth Full Power Bandwidth <sup>2</sup> Slew Rate <sup>3</sup> Settling Time to 0.1%, R <sub>LOAD</sub> = 250 Ω to 0.01%, R <sub>LOAD</sub> = 250 Ω Phase Margin Differential Gain Differential Phase	V <sub>OUT</sub> = 5 V p-p R <sub>LOAD</sub> = 500 Ω, V <sub>OUT</sub> = 20 V p-p, R <sub>LOAD</sub> = 1 kΩ R <sub>LOAD</sub> = 1 kΩ -2.5 V to +2.5 V 10 V Step, A <sub>V</sub> = -1 -2.5 V to +2.5 V 10 V Step, A <sub>V</sub> = -1 C <sub>LOAD</sub> = 10 pF R <sub>LOAD</sub> = 1 kΩ f ≈ 4.4 MHz, R <sub>LOAD</sub> = 1 kΩ f ≈ 4.4 MHz, R <sub>LOAD</sub> = 1 kΩ	±5 V		35			35		MHz	
		±15 V		50			50		MHz	
		±5 V		12.7			12.7		MHz	
		±15 V		4.7			4.7		MHz	
		±5 V	225	200		225	200		V/μs V/μs	
		±15 V	225	300		225	300			
		±5 V		65			65		ns	
		±15 V		65			65		ns	
		±5 V		140			140		ns	
		±15 V		120			120		ns	
COMMON-MODE REJECTION	V <sub>CM</sub> = ±2.5 V V <sub>CM</sub> = ±12 V T <sub>MIN</sub> to T <sub>MAX</sub>	±5 V	<b>80</b>	95		<b>80</b>	95		dB	
		±15 V	<b>80</b>	95		<b>80</b>	95		dB	
			<b>75</b>			<b>75</b>			dB	
POWER SUPPLY REJECTION	V <sub>S</sub> = ±5 V to ±15 V T <sub>MIN</sub> to T <sub>MAX</sub>		<b>75</b>	86		<b>75</b>	86		dB dB	
			<b>72</b>			<b>72</b>				
INPUT VOLTAGE NOISE	f = 10 kHz	±15 V		15			15		nV/√Hz	
INPUT CURRENT NOISE	f = 10 kHz	±15 V		1.5			1.5		pA/√Hz	
INPUT COMMON-MODE VOLTAGE RANGE		±5 V		+4.3 -3.4			+4.3 -3.4		V V	
		±15 V		+14.3 -13.4			+14.3 -13.4		V V	
OUTPUT VOLTAGE SWING Short-Circuit Current	R <sub>LOAD</sub> = 500 Ω R <sub>LOAD</sub> = 150 Ω R <sub>LOAD</sub> = 1 kΩ R <sub>LOAD</sub> = 500 Ω	±5 V	<b>3.0</b>	3.6		<b>3.0</b>	3.6		±V	
		±5 V	<b>2.5</b>	3		<b>2.5</b>	3		±V	
		±15 V	<b>12</b>			<b>12</b>			±V	
		±15 V	<b>10</b>			<b>10</b>			±V	
		±15 V		32			32		mA	
INPUT RESISTANCE				300			300		kΩ	
INPUT CAPACITANCE				1.5			1.5		pF	
OUTPUT RESISTANCE	Open Loop			15			15		Ω	
POWER SUPPLY Operating Range Quiescent Current	T <sub>MIN</sub> to T <sub>MAX</sub>	±5 V	<b>±4.5</b>		<b>±18</b>		<b>±4.5</b>		<b>±18</b>	V mA mA
				4.8	<b>7.0</b>		4.8	<b>7.8</b>		
		±15 V		5.3	<b>6.3</b> <b>7.6</b>		5.3	<b>6.3</b> <b>8.4</b>		mA mA

# AD847

## ABSOLUTE MAXIMUM RATINGS<sup>1</sup>

Supply Voltage	±18 V
Internal Power Dissipation <sup>2</sup>	
Plastic (N)	1.2 Watts
Small Outline (R)	0.8 Watts
Cerdip (Q)	1.1 Watts
Input Voltage	±V <sub>S</sub>
Differential Input Voltage	±6 V
Storage Temperature Range (Q)	-65°C to +150°C
(N, R)	-65°C to +125°C
Junction Temperature	175°C
Lead Temperature Range (Soldering 60 sec)	+300°C

## NOTES

<sup>1</sup>Stresses above those listed under "Absolute Maximum Ratings" may cause permanent damage to the device. This is a stress rating only, and functional operation of the device at these or any other conditions above those indicated in the operational section of this specification is not implied. Exposure to absolute maximum rating conditions for extended periods may affect device reliability.

<sup>2</sup>Mini-DIP Package:  $\theta_{JA} = 100^\circ\text{C/Watt}$ ;  $\theta_{JC} = 33^\circ\text{C/Watt}$

Cerdip Package:  $\theta_{JA} = 110^\circ\text{C/Watt}$ ;  $\theta_{JC} = 30^\circ\text{C/Watt}$

Small Outline Package:  $\theta_{JA} = 155^\circ\text{C/Watt}$ ;  $\theta_{JC} = 33^\circ\text{C/Watt}$

## ESD SUSCEPTIBILITY

ESD (electrostatic discharge) sensitive device. Electrostatic charges as high as 4000 volts, which readily accumulate on the human body and on test equipment, can discharge without detection. Although the AD847 features proprietary ESD protection circuitry, permanent damage may still occur on these devices if they are subjected to high energy electrostatic discharges. Therefore, proper ESD precautions are recommended to avoid any performance degradation or loss of functionality.

## METALIZATION PHOTOGRAPH

Contact factory for latest dimensions.  
Dimensions shown in inches and (mm).



## ORDERING GUIDE

Models*	Temperature Range - °C	Package Description	Package Option
AD847JN	0 to +70	Plastic	N-8
AD847JR	0 to +70	SOIC	R-8
AD847AQ	-40 to +85	Cerdip	Q-8
AD847AR	-40 to +85	SOIC	R-8
AD847SQ	-55 to +125	Cerdip	Q-8
AD847SQ/883B	-55 to +125	Cerdip	Q-8
5962-8964701PA	-55 to +125	Cerdip	Q-8

\*AD847 also available in J and S grade chips, and AD847JR and AD847AR are available in tape and reel.

Typical Characteristics (@ +25°C and  $V_S = \pm 15\text{ V}$ , unless otherwise noted)

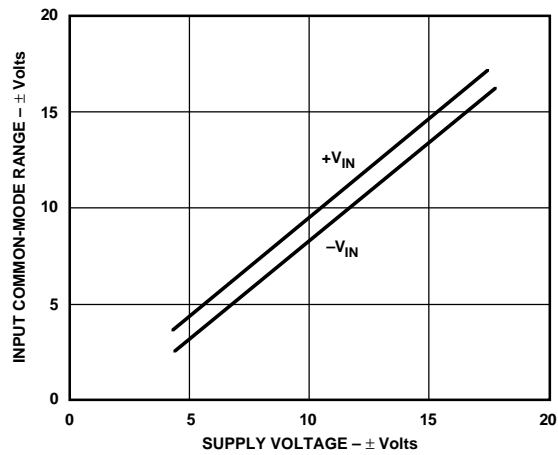

Figure 1. Input Common-Mode Range vs. Supply Voltage

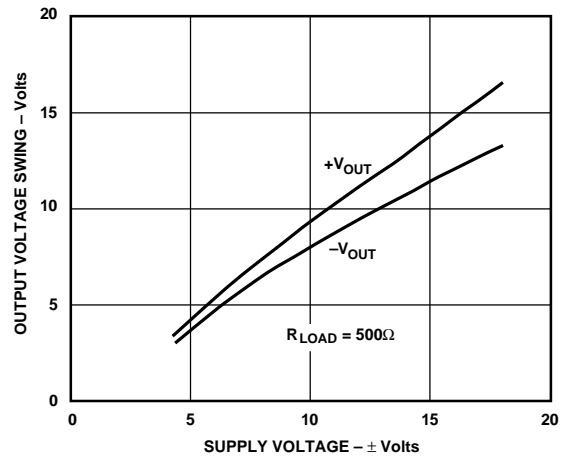

Figure 2. Output Voltage Swing vs. Supply Voltage



Figure 3. Output Voltage Swing vs. Load Resistance



Figure 4. Quiescent Current vs. Supply Voltage



Figure 5. Input Bias Current vs. Temperature



Figure 6. Output Impedance vs. Frequency

# AD847–Typical Characteristics (@ +25°C and $V_S = \pm 15\text{ V}$ , unless otherwise noted)



Figure 7. Quiescent Current vs. Temperature



Figure 8. Short-Circuit Current Limit vs. Temperature



Figure 9. Gain Bandwidth Product vs. Temperature

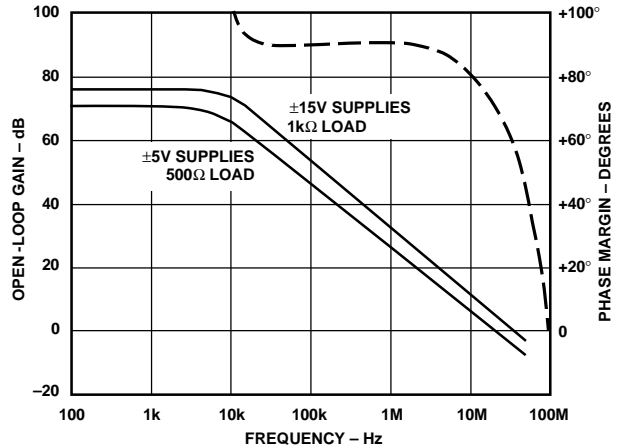

Figure 10. Open-Loop Gain and Phase Margin vs. Frequency



Figure 11. Open-Loop Gain vs. Load Resistance

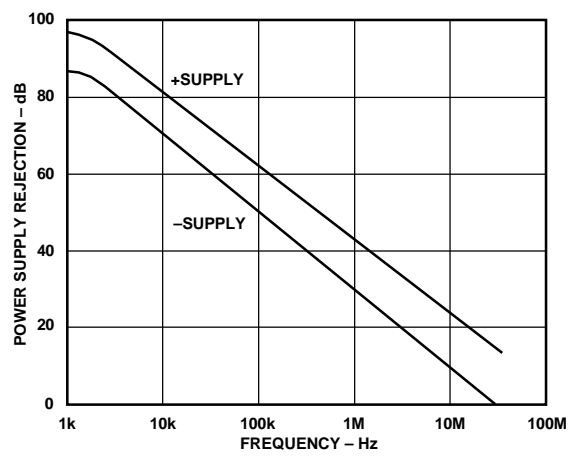

Figure 12. Power Supply Rejection vs. Frequency



Figure 13. Common-Mode Rejection vs. Frequency



Figure 14. Large Signal Frequency Response



Figure 15. Output Swing and Error vs. Settling Time



Figure 16. Harmonic Distortion vs. Frequency



Figure 17. Input Voltage Noise Spectral Density



Figure 18. Slew Rate vs. Temperature



Figure 19. Inverting Amplifier Configuration



Figure 19a. Inverter Large Signal Pulse Response



Figure 19b. Inverter Small Signal Pulse Response



Figure 20. Noninverting Amplifier Configuration



Figure 20a. Noninverting Large Signal Pulse Response



Figure 20b. Noninverting Small Signal Pulse Response



### OFFSET NULLING

The input offset voltage of the AD847 is very low for a high speed op amp, but if additional nulling is required, the circuit shown in Figure 21 can be used.



Figure 21. Offset Nulling

### INPUT CONSIDERATIONS

An input resistor ( $R_{IN}$  in Figure 20) is required in circuits where the input to the AD847 will be subjected to transient or continuous overload voltages exceeding the  $\pm 6$  V maximum differential limit. This resistor provides protection for the input transistors by limiting the maximum current that can be forced into their bases.

For high performance circuits it is recommended that a resistor ( $R_B$  in Figures 19 and 20) be used to reduce bias current errors by matching the impedance at each input. The offset voltage error will be reduced by more than an order of magnitude.

### THEORY OF OPERATION

The AD847 is fabricated on Analog Devices' proprietary complementary bipolar (CB) process which enables the construction of pnp and npn transistors with similar  $f_T$ s in the 600 MHz to 800 MHz region. The AD847 circuit (Figure 22) includes an npn input stage followed by fast pnps in the folded cascode intermediate gain stage. The CB pnps are also used in the current amplifying output stage. The internal compensation capacitance that makes the AD847 unity gain stable is provided by the junction capacitances of transistors in the gain stage.

The capacitor,  $C_F$ , in the output stage mitigates the effect of capacitive loads. At low frequencies and with low capacitive loads, the gain from the compensation node to the output is very close to unity. In this case  $C_F$  is bootstrapped and does not contribute to the compensation capacitance of the part. As the capacitive load is increased, a pole is formed with the output impedance of the output stage. This reduces the gain, and therefore,  $C_F$  is incompletely bootstrapped. Some fraction of  $C_F$  contributes to the compensation capacitance, and the unity gain bandwidth falls. As the load capacitance is increased, the bandwidth continues to fall, and the amplifier remains stable.



Figure 22. AD847 Simplified Schematic

### GROUNDING AND BYPASSING

In designing practical circuits with the AD847, the user must remember that whenever high frequencies are involved, some special precautions are in order. Circuits must be built with short interconnect leads. A large ground plane should be used whenever possible to provide a low resistance, low inductance circuit path, as well as minimizing the effects of high frequency coupling. Sockets should be avoided because the increased interlead capacitance can degrade bandwidth.

Feedback resistors should be of low enough value to assure that the time constant formed with the capacitance at the amplifier summing junction will not limit the amplifier performance. Resistor values of less than 5 k $\Omega$  are recommended. If a larger resistor must be used, a small (<10 pF) feedback capacitor in parallel with the feedback resistor,  $R_F$ , may be used to compensate for the input capacitances and optimize the dynamic performance of the amplifier.

Power supply leads should be bypassed to ground as close as possible to the amplifier pins. Ceramic disc capacitors of 0.1  $\mu$ F are recommended.

# AD847

## VIDEO LINE DRIVER

The AD847 functions very well as a low cost, high speed line driver for either terminated or unterminated cables. Figure 23 shows the AD847 driving a doubly terminated cable in a follower configuration.

The termination resistor,  $R_T$ , (when equal to the cable's characteristic impedance) minimizes reflections from the far end of the cable. While operating from  $\pm 5$  V supplies, the AD847 maintains a typical slew rate of 200 V/ $\mu$ s, which means it can drive a  $\pm 1$  V, 30 MHz signal into a terminated cable.



Figure 23. Video Line Driver

Table I. Video Line Driver Performance Chart

$V_{IN}^*$	$V_{SUPPLY}$	$C_C$	-3 dB $B_W$	Over-shoot
0 dB or $\pm 500$ mV Step	$\pm 15$	20 pF	23 MHz	4%
0 dB or $\pm 500$ mV Step	$\pm 15$	15 pF	21 MHz	0%
0 dB or $\pm 500$ mV Step	$\pm 15$	0 pF	13 MHz	0%
0 dB or $\pm 500$ mV Step	$\pm 5$	20 pF	18 MHz	2%
0 dB or $\pm 500$ mV Step	$\pm 5$	15 pF	16 MHz	0%
0 dB or $\pm 500$ mV Step	$\pm 5$	0 pF	11 MHz	0%

\*-3 dB bandwidth numbers are for the 0 dBm signal input. Overshoot numbers are the percent overshoot of the 1 volt step input.

A back-termination resistor ( $R_{BT}$ , also equal to the characteristic impedance of the cable) may be placed between the AD847 output and the cable input, in order to damp any reflected signals caused by a mismatch between  $R_T$  and the cable's characteristic impedance. This will result in a flatter frequency response, although this requires that the op amp supply  $\pm 2$  V to the output in order to achieve a  $\pm 1$  V swing at resistor  $R_T$ .

Figure 24 shows the AD847 driving 100 pF and 1000 pF loads.

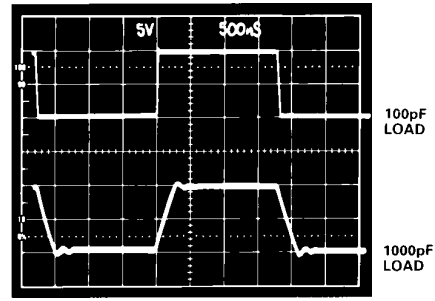

Figure 24. AD847 Driving Capacitive Loads

## FLASH ADC INPUT BUFFER

The 35 MHz unity gain bandwidth of the AD847 makes it an excellent choice for buffering the input of high speed flash A/D converters, such as the AD9048.

Figure 25 shows the AD847 as a unity inverter for the input to the AD9048.

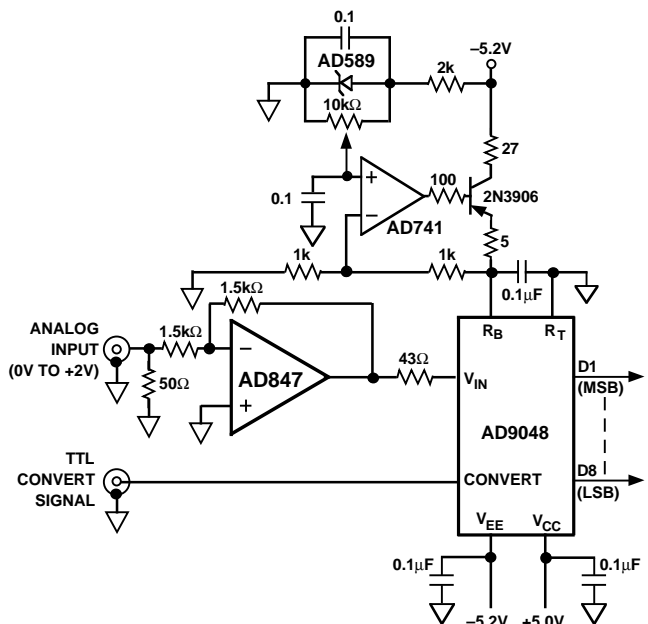

Figure 25. Flash ADC Input Buffer

**A High Speed, Three Op-Amp In-Amp**

The circuit of Figure 26 lends itself well to CCD imaging and other video speed applications. It uses two high speed CB process op-amps: Amplifier A3, the output amplifier, is an AD847.

The input amplifier (A1 and A2) is an AD827, which is a dual version of the AD847. This circuit has the optional flexibility of both dc and ac trims for common-mode rejection, plus the ability to adjust for minimum settling time.



**BANDWIDTH, SETTling TIME AND TOTAL HARMONIC DISTORTION VS. GAIN**

GAIN	R <sub>G</sub>	C <sub>ADJ</sub> (pF)	SMALL SIGNAL BANDWIDTH	SETTLING TIME TO 0.1%	THD + NOISE BELOW INPUT LEVEL @ 10kHz
1	OPEN	2-8	16.1MHz	200ns	82dB
2	2kΩ	2-8	14.7MHz	200ns	82dB
10	226Ω	2-8	4.5MHz	370ns	81dB
100	20Ω	2-8	660kHz	2.5µs	71dB

Figure 26. A High Speed In-Amp Circuit for Data Acquisition

# AD847

## HIGH SPEED DAC BUFFER

The wide bandwidth and fast settling time of the AD847 makes it a very good output buffer for high speed current-output D/A converters like the AD668. As shown in Figure 27, the op amp establishes a summing node at ground for the DAC output. The output voltage is determined by the amplifier's feedback resistor

(10.24 V for a 1 kΩ resistor). Note that since the DAC generates a positive current to ground, the voltage at the amplifier output will be negative. A 100 Ω series resistor between the noninverting amplifier input and ground minimizes the offset effects of op amp input bias currents.



Figure 27. High Speed DAC Buffer

## OUTLINE DIMENSIONS

Dimensions shown in inches and (mm).

### Mini-DIP (N-8) Package



### Cerdip (Q-8) Package



### Small Outline (R-8) Package





Компания «ЭлектроПласт» предлагает заключение долгосрочных отношений при поставках импортных электронных компонентов на взаимовыгодных условиях!

Наши преимущества:

- Оперативные поставки широкого спектра электронных компонентов отечественного и импортного производства напрямую от производителей и с крупнейших мировых складов;
- Поставка более 17-ти миллионов наименований электронных компонентов;
- Поставка сложных, дефицитных, либо снятых с производства позиций;
- Оперативные сроки поставки под заказ (от 5 рабочих дней);
- Экспресс доставка в любую точку России;
- Техническая поддержка проекта, помощь в подборе аналогов, поставка прототипов;
- Система менеджмента качества сертифицирована по Международному стандарту ISO 9001;
- Лицензия ФСБ на осуществление работ с использованием сведений, составляющих государственную тайну;
- Поставка специализированных компонентов (Xilinx, Altera, Analog Devices, Intersil, Interpoint, Microsemi, Aeroflex, Peregrine, Syfer, Eurofarad, Texas Instrument, Miteq, Cobham, E2V, MA-COM, Hittite, Mini-Circuits, General Dynamics и др.);

Помимо этого, одним из направлений компании «ЭлектроПласт» является направление «Источники питания». Мы предлагаем Вам помощь Конструкторского отдела:

- Подбор оптимального решения, техническое обоснование при выборе компонента;
- Подбор аналогов;
- Консультации по применению компонента;
- Поставка образцов и прототипов;
- Техническая поддержка проекта;
- Защита от снятия компонента с производства.



#### Как с нами связаться

**Телефон:** 8 (812) 309 58 32 (многоканальный)

**Факс:** 8 (812) 320-02-42

**Электронная почта:** [org@eplast1.ru](mailto:org@eplast1.ru)

**Адрес:** 198099, г. Санкт-Петербург, ул. Калинина, дом 2, корпус 4, литера А.