

RFID Reader (Passive)

ARRCN5-868.000MHz

RoHS/RoHS II Compliant



20.5 x 20.5 x 7.8mm

MSL level: Not Applicable

FEATURES:

- High Gain
- Easy to install
- RF Cable and Connector
- RoHS Compliant

TYPICAL APPLICATIONS:

RFID systems for Logistic & Inventory Management of Retail, Pharmaceutical, Automotive Industries; Industrial automation, Contactless smart cards.

STANDARD SPECIFICATIONS:

Parameters	Min.	Typ.	Max.	Units	Note
Center Frequency		868±3		MHz	
V.S.W.R		1.5			
Bandwidth	2.0			MHz	V.S.W.R<1.5
Impedence		50		Ω	
Gain		-5.0		dBi	Based on 70×70mm ground plane
Polarization		RHCP			
Working Temperature	-40		+80	°C	
Storage Temperature	-45		+85	°C	

SMITH CHART:

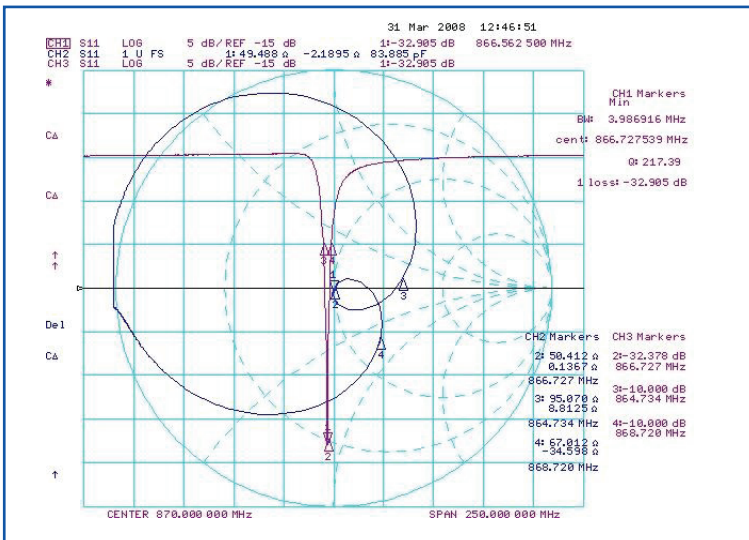

RADIATION PATTERN

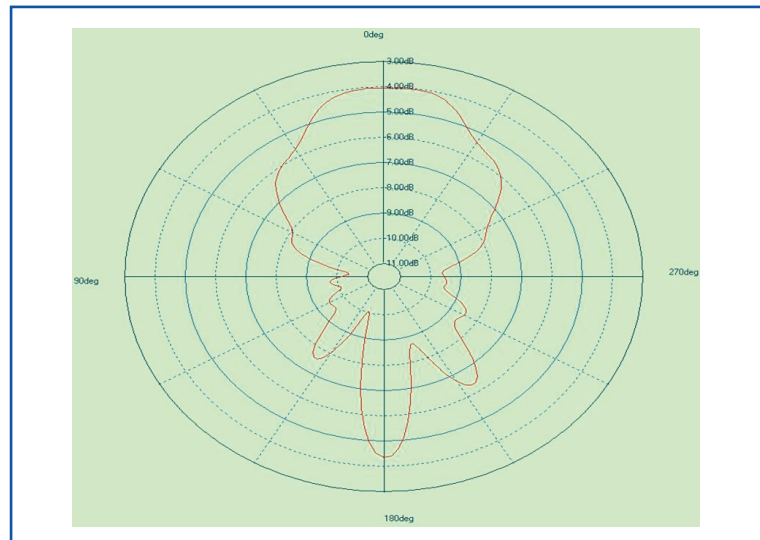

OUTLINE DRAWING:

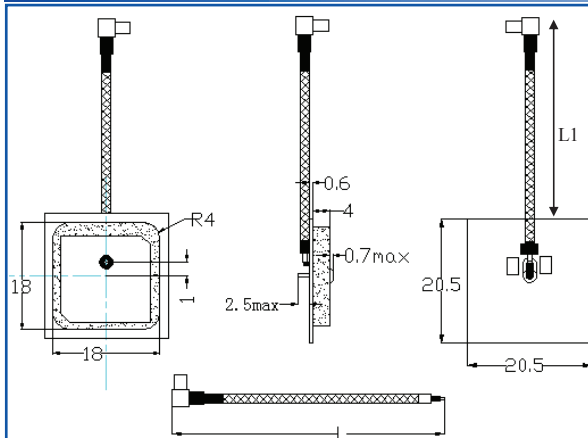

Unit: mm

Other Tolerance: ±0.2mm

Description	Material
Antenna Type	Dielectric 18x18x4mm Ceramics
PCB	FR4, 20.5mm
RF Cable	RG178, Ø2.7±0.3mm , L1=100± 5mm, L=110± 5mm
RF Connector	MMCX-JW3
Thickness	7.8mm Max

ABRACON IS
ISO9001:2008
CERTIFIED



Visit www.abracon.com for Terms & Conditions of Sale **Revised 11.17.14**
30332 Esperanza, Rancho Santa Margarita, California 92688
tel 949-546-8000 | fax 949-546-8001 | www.abracon.com

RFID Reader (Passive)

ARRCN5-868.000MHz

RoHS/RoHS II Compliant



20.5 x 20.5 x 7.8mm

TAPE & REEL:

Each tray contains 50pcs of RFID Reader. There are 5 trays per vacuum bag, and 4 vacuum bags per carton (outer box). The size of each carton is 345*210*275mm.

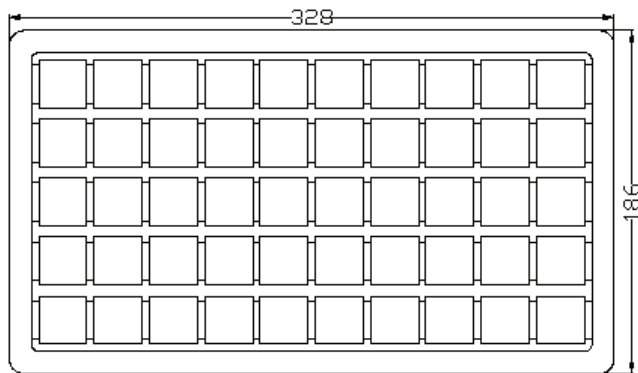

Tray

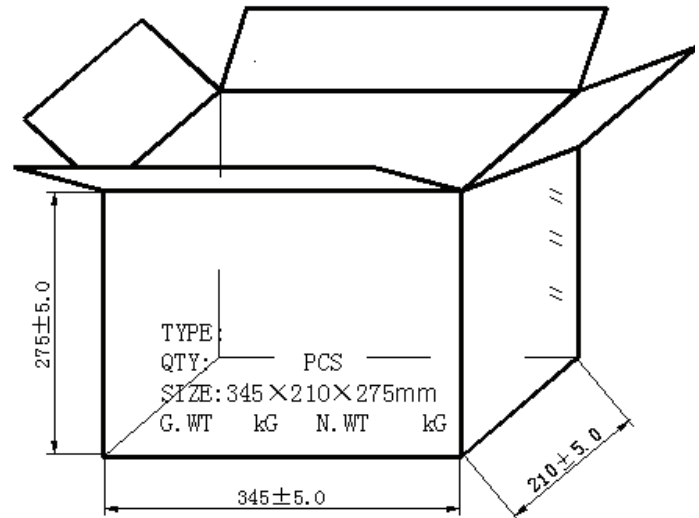

Outer Box

Package Type	Quantity
Tray	50 pcs/tray
Vacuum Bag	200pcs/vacuum bag
Outer Box	1000 pcs/outer box

Unit: mm

CAUTION:

- (1) Do not apply excess mechanical stress to the component body or terminations. Do not attempt to re-form or bend the components as this will cause damage to the component.
- (2) Do not expose the component to open flame.
- (3) This specification applies to the functionality of the component as a single unit. Please insure the component is thoroughly evaluated in the application circuit.

NOTE:

- (1) The parts are manufactured in accordance with this specification. If other conditions and specifications which are required for this specification, please contact ABRACON for more information.
- (2) ABRACON will supply the parts in accordance with this specification unless we receive a written request to modify prior to an order placement.
- (3) In no case shall ABRACON be liable for any product failure from in appropriate handling or operation of the item beyond the scope of this specification.
- (4) When changing your production process, please notify ABRACON immediately.
- (5) ABRACON Corporation's products are COTS – Commercial-Off-The-Shelf products; suitable for Commercial, Industrial and, where designated, Automotive Applications. ABRACON's products are not specifically designed for Military, Aviation, Aerospace, Life-dependant Medical applications or any application requiring high reliability where component failure could result in loss of life and/or property. For applications requiring high reliability and/or presenting an extreme operating environment, written consent and authorization from ABRACON Corporation is required. Please contact ABRACON Corporation for more information.
- (6) All specifications and Marking will be subject to change without notice.

ATTENTION: Abracon Corporation's products are COTS – Commercial-Off-The-Shelf products; suitable for Commercial, Industrial and, where designated, Automotive Applications. Abracon's products are not specifically designed for Military, Aviation, Aerospace, Life-dependant Medical applications or any application requiring high reliability where component failure could result in loss of life and/or property. For applications requiring high reliability and/or presenting an extreme operating environment, written consent and authorization from Abracon Corporation is required. Please contact Abracon Corporation for more information.

ABRACON IS
ISO9001:2008
CERTIFIED



Visit www.abracon.com for Terms & Conditions of Sale **Revised 11.17.14**
30332 Esperanza, Rancho Santa Margarita, California 92688
tel 949-546-8000 | fax 949-546-8001 | www.abracon.com



Компания «ЭлектроПласт» предлагает заключение долгосрочных отношений при поставках импортных электронных компонентов на взаимовыгодных условиях!

Наши преимущества:

- Оперативные поставки широкого спектра электронных компонентов отечественного и импортного производства напрямую от производителей и с крупнейших мировых складов;
- Поставка более 17-ти миллионов наименований электронных компонентов;
- Поставка сложных, дефицитных, либо снятых с производства позиций;
- Оперативные сроки поставки под заказ (от 5 рабочих дней);
- Экспресс доставка в любую точку России;
- Техническая поддержка проекта, помощь в подборе аналогов, поставка прототипов;
- Система менеджмента качества сертифицирована по Международному стандарту ISO 9001;
- Лицензия ФСБ на осуществление работ с использованием сведений, составляющих государственную тайну;
- Поставка специализированных компонентов (Xilinx, Altera, Analog Devices, Intersil, Interpoint, Microsemi, Aeroflex, Peregrine, Syfer, Eurofarad, Texas Instrument, Miteq, Cobham, E2V, MA-COM, Hittite, Mini-Circuits, General Dynamics и др.);

Помимо этого, одним из направлений компании «ЭлектроПласт» является направление «Источники питания». Мы предлагаем Вам помощь Конструкторского отдела:

- Подбор оптимального решения, техническое обоснование при выборе компонента;
- Подбор аналогов;
- Консультации по применению компонента;
- Поставка образцов и прототипов;
- Техническая поддержка проекта;
- Защита от снятия компонента с производства.



Как с нами связаться

Телефон: 8 (812) 309 58 32 (многоканальный)

Факс: 8 (812) 320-02-42

Электронная почта: org@eplast1.ru

Адрес: 198099, г. Санкт-Петербург, ул. Калинина, дом 2, корпус 4, литера А.