

## HIGH RIPPLE-REJECTION LOW DROPOUT MIDDLE OUTPUT CURRENT CMOS VOLTAGE REGULATOR

S-1135 Series, developed using the CMOS technology, is a positive voltage regulator IC which has the low dropout voltage, the high-accuracy output voltage and the low current consumption (300 mA output current).

A 1.0  $\mu$ F small ceramic capacitor can be used. It operates with low current consumption of 45  $\mu$ A typ.

The overcurrent protection circuit prevents the load current from exceeding the capacitance of output transistor. The power-off circuit ensures longer battery life.

Various capacitors, also small ceramic capacitors, can be used for this IC more than for the conventional regulator ICs which have CMOS technology.

Furthermore a small SOT-89-5, SOT-23-5, and HSNT-6A packages realize high-density mounting.

### ■ Features

- Output voltage: 1.0 V to 3.5 V, selectable in 0.05 V step.
- Low equivalent series resistance capacitor : Ceramic capacitor of 1.0  $\mu$ F or more can be used as the I/O capacitor.
- Wide input voltage range: 1.5 V to 5.5 V
- High-accuracy output voltage:  $\pm 1.0\%$  (1.0 V to 1.45 V output product :  $\pm 15$  mV)
- Low dropout voltage: 160 mV typ. (products having the output of 2.6 V,  $I_{OUT} = 300$  mA)
- Low current consumption:
  - During operation: 45  $\mu$ A typ., 65  $\mu$ A max.
  - During power-off: 0.1  $\mu$ A typ., 1.0  $\mu$ A max.
- Output current: Possible to output 300 mA (at  $V_{IN} \geq V_{OUT(S)} + 1.0$  V)<sup>\*1</sup>
- High ripple rejection: 70 dB typ. (at 1.0 kHz,  $V_{OUT} = 1.0$  V)
- Built-in overcurrent protection circuit: limits overcurrent of output transistor
- Built-in power-off circuit: Ensures long battery life.
- Discharge shunt circuit can be selected.
- Resistor is selectable in pull-up or pull-down
- Lead-free, Sn 100%, halogen-free<sup>\*2</sup>

\*1. Attention should be paid to the power dissipation of the package when the output current is large.

\*2. Refer to “**■ Product Name Structure**” for details.

### ■ Applications

- Power supply for battery-powered devices
- Power supply for cellular phones
- Power supply for portable equipment

### ■ Packages

- SOT-89-5
- SOT-23-5
- HSNT-6A

■ **Block Diagrams**

1. **S-1135 Series A type**



Function	Status
ON / OFF logic	Active "H"
Discharge shunt function	Available
Pull-up resistor	None
Pull-down resistor	Available

\*1. Parasitic diode

Figure 1

2. **S-1135 Series B type**



Function	Status
ON / OFF logic	Active "H"
Discharge shunt function	Available
Pull-up resistor	None
Pull-down resistor	None

\*1. Parasitic diode

Figure 2

3. S-1135 Series C type

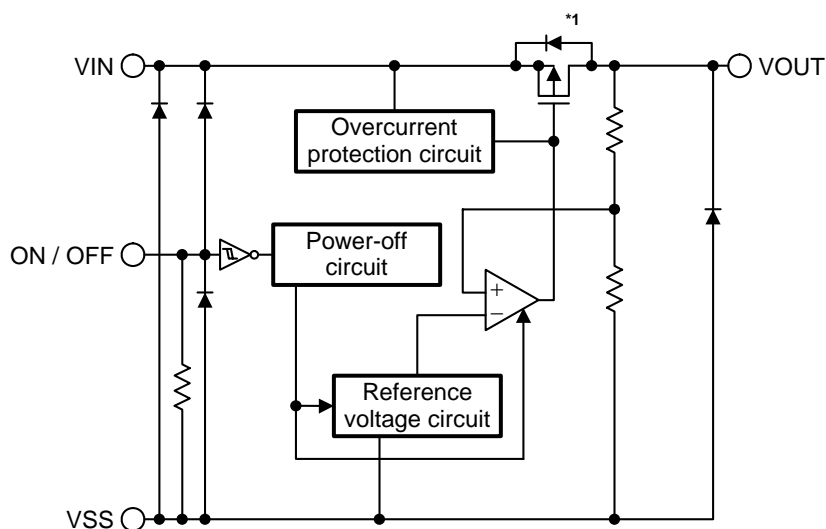

Function	Status
ON / OFF logic	Active "H"
Discharge shunt function	None
Pull-up resistor	None
Pull-down resistor	Available

\*1. Parasitic diode

Figure 3

4. S-1135 Series D type

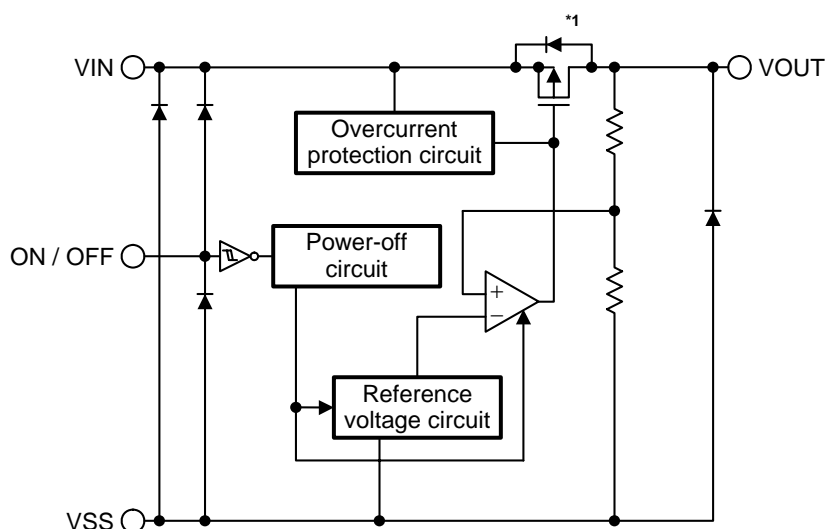

Function	Status
ON / OFF logic	Active "H"
Discharge shunt function	None
Pull-up resistor	None
Pull-down resistor	None

\*1. Parasitic diode

Figure 4

**5. S-1135 Series E type**



Function	Status
ON / OFF logic	Active "L"
Discharge shunt function	Available
Pull-up resistor	Available
Pull-down resistor	None

\*1. Parasitic diode

**Figure 5**

**6. S-1135 Series F type**



Function	Status
ON / OFF logic	Active "L"
Discharge shunt function	Available
Pull-up resistor	None
Pull-down resistor	None

\*1. Parasitic diode

**Figure 6**

7. S-1135 Series G type



Function	Status
ON / OFF logic	Active "L"
Discharge shunt function	None
Pull-up resistor	Available
Pull-down resistor	None

\*1. Parasitic diode

Figure 7

8. S-1135 Series H type



Function	Status
ON / OFF logic	Active "L"
Discharge shunt function	None
Pull-up resistor	None
Pull-down resistor	None

\*1. Parasitic diode

Figure 8

■ **Product Name Structure**

Users can select the product type, output voltage, and package type for the S-1135 Series. Refer to “1. **Product name**” regarding the contents of product name, “2. **Function list of product type**” regarding the product type, “3. **Package**” regarding the package drawings.

**1. Product name**

**(1) SOT-89-5**



- \*1. Refer to the tape specifications.
- \*2. If you request the product which has 0.05 V step, contact our sales office.
- \*3. Refer to “2. **Function list of product type**”.

**(2) SOT-23-5, HSNT-6A**

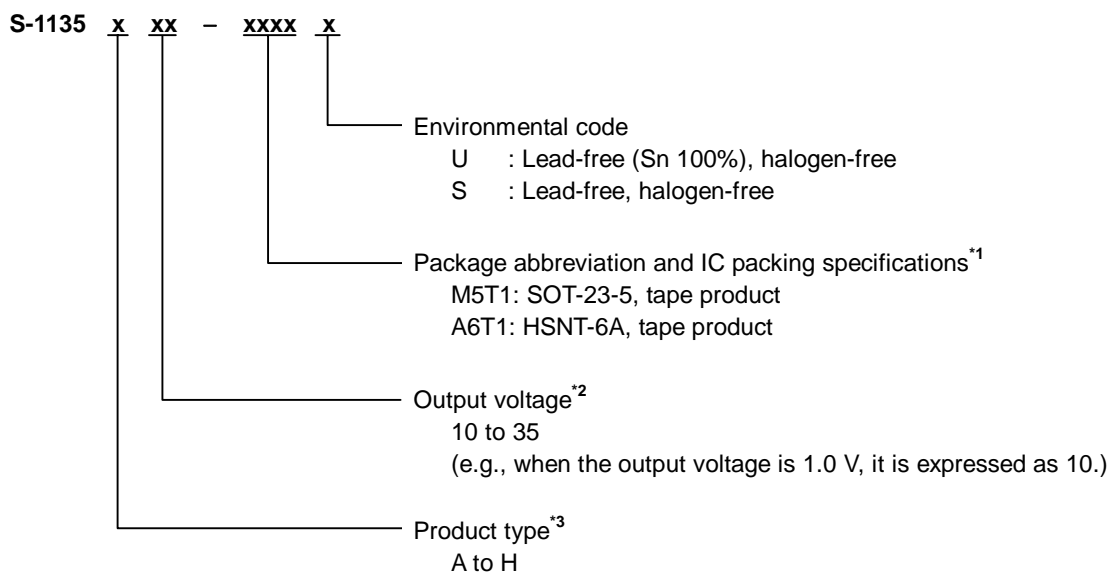

- \*1. Refer to the tape specifications.
- \*2. If you request the product which has 0.05 V step, contact our sales office.
- \*3. Refer to “2. **Function list of product type**”.

**2. Function list of product type**

**Table 1**

Product Type	ON / OFF Logic	Discharge Shunt Function	Pull-up Resistor	Pull-down Resistor
A	Active high	Available	None	Available
B	Active high	Available	None	None
C	Active high	None	None	Available
D	Active high	None	None	None
E	Active low	Available	Available	None
F	Active low	Available	None	None
G	Active low	None	Available	None
H	Active low	None	None	None

**3. Package**

Package Name	Drawing Code				
	Package	Tape	Reel	Land	Stencil Opening
SOT-89-5	UP005-A-P-SD	UP005-A-C-SD	UP005-A-R-SD	—	—
SOT-23-5	MP005-A-P-SD	MP005-A-C-SD	MP005-A-R-SD	—	—
HSNT-6A	PJ006-A-P-SD	PJ006-A-C-SD	PJ006-A-R-SD	PJ006-A-LM-SD	PJ006-A-LM-SD

**4. Product name list**

**4.1 S-1135 series A type**

ON / OFF logic: Active high Pull-up resistor: None  
 Discharge shunt function: Available Pull-down resistor: Available

**Table 2**

Output Voltage	SOT-89-5	SOT-23-5	HSNT-6A
1.0 V $\pm$ 15 mV	S-1135A10-U5T1x	S-1135A10-M5T1y	S-1135A10-A6T1y
1.1 V $\pm$ 15 mV	S-1135A11-U5T1x	S-1135A11-M5T1y	S-1135A11-A6T1y
1.2 V $\pm$ 15 mV	S-1135A12-U5T1x	S-1135A12-M5T1y	S-1135A12-A6T1y
1.3 V $\pm$ 15 mV	S-1135A13-U5T1x	S-1135A13-M5T1y	S-1135A13-A6T1y
1.4 V $\pm$ 15 mV	S-1135A14-U5T1x	S-1135A14-M5T1y	S-1135A14-A6T1y
1.5 V $\pm$ 1.0%	S-1135A15-U5T1x	S-1135A15-M5T1y	S-1135A15-A6T1y
1.6 V $\pm$ 1.0%	S-1135A16-U5T1x	S-1135A16-M5T1y	S-1135A16-A6T1y
1.7 V $\pm$ 1.0%	S-1135A17-U5T1x	S-1135A17-M5T1y	S-1135A17-A6T1y
1.8 V $\pm$ 1.0%	S-1135A18-U5T1x	S-1135A18-M5T1y	S-1135A18-A6T1y
1.85 V $\pm$ 1.0%	S-1135A1J-U5T1x	S-1135A1J-M5T1y	S-1135A1J-A6T1y
1.9 V $\pm$ 1.0%	S-1135A19-U5T1x	S-1135A19-M5T1y	S-1135A19-A6T1y
2.0 V $\pm$ 1.0%	S-1135A20-U5T1x	S-1135A20-M5T1y	S-1135A20-A6T1y
2.1 V $\pm$ 1.0%	S-1135A21-U5T1x	S-1135A21-M5T1y	S-1135A21-A6T1y
2.2 V $\pm$ 1.0%	S-1135A22-U5T1x	S-1135A22-M5T1y	S-1135A22-A6T1y
2.3 V $\pm$ 1.0%	S-1135A23-U5T1x	S-1135A23-M5T1y	S-1135A23-A6T1y
2.4 V $\pm$ 1.0%	S-1135A24-U5T1x	S-1135A24-M5T1y	S-1135A24-A6T1y
2.5 V $\pm$ 1.0%	S-1135A25-U5T1x	S-1135A25-M5T1y	S-1135A25-A6T1y
2.6 V $\pm$ 1.0%	S-1135A26-U5T1x	S-1135A26-M5T1y	S-1135A26-A6T1y
2.7 V $\pm$ 1.0%	S-1135A27-U5T1x	S-1135A27-M5T1y	S-1135A27-A6T1y
2.8 V $\pm$ 1.0%	S-1135A28-U5T1x	S-1135A28-M5T1y	S-1135A28-A6T1y
2.85 V $\pm$ 1.0%	S-1135A2J-U5T1x	S-1135A2J-M5T1y	S-1135A2J-A6T1y
2.9 V $\pm$ 1.0%	S-1135A29-U5T1x	S-1135A29-M5T1y	S-1135A29-A6T1y
3.0 V $\pm$ 1.0%	S-1135A30-U5T1x	S-1135A30-M5T1y	S-1135A30-A6T1y
3.1 V $\pm$ 1.0%	S-1135A31-U5T1x	S-1135A31-M5T1y	S-1135A31-A6T1y
3.2 V $\pm$ 1.0%	S-1135A32-U5T1x	S-1135A32-M5T1y	S-1135A32-A6T1y
3.3 V $\pm$ 1.0%	S-1135A33-U5T1x	S-1135A33-M5T1y	S-1135A33-A6T1y
3.4 V $\pm$ 1.0%	S-1135A34-U5T1x	S-1135A34-M5T1y	S-1135A34-A6T1y
3.5 V $\pm$ 1.0%	S-1135A35-U5T1x	S-1135A35-M5T1y	S-1135A35-A6T1y

- Remark 1.** Please contact our sales office for products with specifications other than the above.  
**2.** x: G or U  
 y: S or U  
**3.** Please select products of environmental code = U for Sn 100%, halogen-free products.



# HIGH RIPPLE-REJECTION LOW DROPOUT MIDDLE OUTPUT CURRENT CMOS VOLTAGE REGULATOR

Rev.2.0\_00

S-1135 Series

## 4.2 S-1135 series B type

ON / OFF logic: Active high                      Pull-up resistor: None  
 Discharge shunt function: Available                      Pull-down resistor: None

**Table 3**

Output Voltage	SOT-89-5	SOT-23-5	HSNT-6A
1.0 V $\pm$ 15 mV	S-1135B10-U5T1x	S-1135B10-M5T1y	S-1135B10-A6T1y
1.1 V $\pm$ 15 mV	S-1135B11-U5T1x	S-1135B11-M5T1y	S-1135B11-A6T1y
1.2 V $\pm$ 15 mV	S-1135B12-U5T1x	S-1135B12-M5T1y	S-1135B12-A6T1y
1.3 V $\pm$ 15 mV	S-1135B13-U5T1x	S-1135B13-M5T1y	S-1135B13-A6T1y
1.4 V $\pm$ 15 mV	S-1135B14-U5T1x	S-1135B14-M5T1y	S-1135B14-A6T1y
1.5 V $\pm$ 1.0%	S-1135B15-U5T1x	S-1135B15-M5T1y	S-1135B15-A6T1y
1.6 V $\pm$ 1.0%	S-1135B16-U5T1x	S-1135B16-M5T1y	S-1135B16-A6T1y
1.7 V $\pm$ 1.0%	S-1135B17-U5T1x	S-1135B17-M5T1y	S-1135B17-A6T1y
1.8 V $\pm$ 1.0%	S-1135B18-U5T1x	S-1135B18-M5T1y	S-1135B18-A6T1y
1.85 V $\pm$ 1.0%	S-1135B1J-U5T1x	S-1135B1J-M5T1y	S-1135B1J-A6T1y
1.9 V $\pm$ 1.0%	S-1135B19-U5T1x	S-1135B19-M5T1y	S-1135B19-A6T1y
2.0 V $\pm$ 1.0%	S-1135B20-U5T1x	S-1135B20-M5T1y	S-1135B20-A6T1y
2.1 V $\pm$ 1.0%	S-1135B21-U5T1x	S-1135B21-M5T1y	S-1135B21-A6T1y
2.2 V $\pm$ 1.0%	S-1135B22-U5T1x	S-1135B22-M5T1y	S-1135B22-A6T1y
2.3 V $\pm$ 1.0%	S-1135B23-U5T1x	S-1135B23-M5T1y	S-1135B23-A6T1y
2.4 V $\pm$ 1.0%	S-1135B24-U5T1x	S-1135B24-M5T1y	S-1135B24-A6T1y
2.5 V $\pm$ 1.0%	S-1135B25-U5T1x	S-1135B25-M5T1y	S-1135B25-A6T1y
2.6 V $\pm$ 1.0%	S-1135B26-U5T1x	S-1135B26-M5T1y	S-1135B26-A6T1y
2.7 V $\pm$ 1.0%	S-1135B27-U5T1x	S-1135B27-M5T1y	S-1135B27-A6T1y
2.8 V $\pm$ 1.0%	S-1135B28-U5T1x	S-1135B28-M5T1y	S-1135B28-A6T1y
2.85 V $\pm$ 1.0%	S-1135B2J-U5T1x	S-1135B2J-M5T1y	S-1135B2J-A6T1y
2.9 V $\pm$ 1.0%	S-1135B29-U5T1x	S-1135B29-M5T1y	S-1135B29-A6T1y
3.0 V $\pm$ 1.0%	S-1135B30-U5T1x	S-1135B30-M5T1y	S-1135B30-A6T1y
3.1 V $\pm$ 1.0%	S-1135B31-U5T1x	S-1135B31-M5T1y	S-1135B31-A6T1y
3.2 V $\pm$ 1.0%	S-1135B32-U5T1x	S-1135B32-M5T1y	S-1135B32-A6T1y
3.3 V $\pm$ 1.0%	S-1135B33-U5T1x	S-1135B33-M5T1y	S-1135B33-A6T1y
3.4 V $\pm$ 1.0%	S-1135B34-U5T1x	S-1135B34-M5T1y	S-1135B34-A6T1y
3.5 V $\pm$ 1.0%	S-1135B35-U5T1x	S-1135B35-M5T1y	S-1135B35-A6T1y

- Remark 1.** Please contact our sales office for products with specifications other than the above.
2. x: G or U  
y: S or U
  3. Please select products of environmental code = U for Sn 100%, halogen-free products.

**4.3 S-1135 series C type**

ON / OFF logic: Active high                      Pull-up resistor: None  
 Discharge shunt function: None                      Pull-down resistor: Available

**Table 4**

Output Voltage	SOT-89-5	SOT-23-5	HSNT-6A
1.0 V $\pm$ 15 mV	S-1135C10-U5T1x	S-1135C10-M5T1y	S-1135C10-A6T1y
1.1 V $\pm$ 15 mV	S-1135C11-U5T1x	S-1135C11-M5T1y	S-1135C11-A6T1y
1.2 V $\pm$ 15 mV	S-1135C12-U5T1x	S-1135C12-M5T1y	S-1135C12-A6T1y
1.3 V $\pm$ 15 mV	S-1135C13-U5T1x	S-1135C13-M5T1y	S-1135C13-A6T1y
1.4 V $\pm$ 15 mV	S-1135C14-U5T1x	S-1135C14-M5T1y	S-1135C14-A6T1y
1.5 V $\pm$ 1.0%	S-1135C15-U5T1x	S-1135C15-M5T1y	S-1135C15-A6T1y
1.6 V $\pm$ 1.0%	S-1135C16-U5T1x	S-1135C16-M5T1y	S-1135C16-A6T1y
1.7 V $\pm$ 1.0%	S-1135C17-U5T1x	S-1135C17-M5T1y	S-1135C17-A6T1y
1.8 V $\pm$ 1.0%	S-1135C18-U5T1x	S-1135C18-M5T1y	S-1135C18-A6T1y
1.85 V $\pm$ 1.0%	S-1135C1J-U5T1x	S-1135C1J-M5T1y	S-1135C1J-A6T1y
1.9 V $\pm$ 1.0%	S-1135C19-U5T1x	S-1135C19-M5T1y	S-1135C19-A6T1y
2.0 V $\pm$ 1.0%	S-1135C20-U5T1x	S-1135C20-M5T1y	S-1135C20-A6T1y
2.1 V $\pm$ 1.0%	S-1135C21-U5T1x	S-1135C21-M5T1y	S-1135C21-A6T1y
2.2 V $\pm$ 1.0%	S-1135C22-U5T1x	S-1135C22-M5T1y	S-1135C22-A6T1y
2.3 V $\pm$ 1.0%	S-1135C23-U5T1x	S-1135C23-M5T1y	S-1135C23-A6T1y
2.4 V $\pm$ 1.0%	S-1135C24-U5T1x	S-1135C24-M5T1y	S-1135C24-A6T1y
2.5 V $\pm$ 1.0%	S-1135C25-U5T1x	S-1135C25-M5T1y	S-1135C25-A6T1y
2.6 V $\pm$ 1.0%	S-1135C26-U5T1x	S-1135C26-M5T1y	S-1135C26-A6T1y
2.7 V $\pm$ 1.0%	S-1135C27-U5T1x	S-1135C27-M5T1y	S-1135C27-A6T1y
2.8 V $\pm$ 1.0%	S-1135C28-U5T1x	S-1135C28-M5T1y	S-1135C28-A6T1y
2.85 V $\pm$ 1.0%	S-1135C2J-U5T1x	S-1135C2J-M5T1y	S-1135C2J-A6T1y
2.9 V $\pm$ 1.0%	S-1135C29-U5T1x	S-1135C29-M5T1y	S-1135C29-A6T1y
3.0 V $\pm$ 1.0%	S-1135C30-U5T1x	S-1135C30-M5T1y	S-1135C30-A6T1y
3.1 V $\pm$ 1.0%	S-1135C31-U5T1x	S-1135C31-M5T1y	S-1135C31-A6T1y
3.2 V $\pm$ 1.0%	S-1135C32-U5T1x	S-1135C32-M5T1y	S-1135C32-A6T1y
3.3 V $\pm$ 1.0%	S-1135C33-U5T1x	S-1135C33-M5T1y	S-1135C33-A6T1y
3.4 V $\pm$ 1.0%	S-1135C34-U5T1x	S-1135C34-M5T1y	S-1135C34-A6T1y
3.5 V $\pm$ 1.0%	S-1135C35-U5T1x	S-1135C35-M5T1y	S-1135C35-A6T1y

- Remark 1.** Please contact our sales office for products with specifications other than the above.
2. x: G or U  
y: S or U
  3. Please select products of environmental code = U for Sn 100%, halogen-free products.

**4.4 S-1135 series D type**

ON / OFF logic: Active high                      Pull-up resistor: None  
 Discharge shunt function: None                      Pull-down resistor: None

**Table 5**

Output Voltage	SOT-89-5	SOT-23-5	HSNT-6A
1.0 V ±15 mV	S-1135D10-U5T1x	S-1135D10-M5T1y	S-1135D10-A6T1y
1.1 V ±15 mV	S-1135D11-U5T1x	S-1135D11-M5T1y	S-1135D11-A6T1y
1.2 V ±15 mV	S-1135D12-U5T1x	S-1135D12-M5T1y	S-1135D12-A6T1y
1.3 V ±15 mV	S-1135D13-U5T1x	S-1135D13-M5T1y	S-1135D13-A6T1y
1.4 V ±15 mV	S-1135D14-U5T1x	S-1135D14-M5T1y	S-1135D14-A6T1y
1.5 V ±1.0%	S-1135D15-U5T1x	S-1135D15-M5T1y	S-1135D15-A6T1y
1.6 V ±1.0%	S-1135D16-U5T1x	S-1135D16-M5T1y	S-1135D16-A6T1y
1.7 V ±1.0%	S-1135D17-U5T1x	S-1135D17-M5T1y	S-1135D17-A6T1y
1.8 V ±1.0%	S-1135D18-U5T1x	S-1135D18-M5T1y	S-1135D18-A6T1y
1.85 V ±1.0%	S-1135D1J-U5T1x	S-1135D1J-M5T1y	S-1135D1J-A6T1y
1.9 V ±1.0%	S-1135D19-U5T1x	S-1135D19-M5T1y	S-1135D19-A6T1y
2.0 V ±1.0%	S-1135D20-U5T1x	S-1135D20-M5T1y	S-1135D20-A6T1y
2.1 V ±1.0%	S-1135D21-U5T1x	S-1135D21-M5T1y	S-1135D21-A6T1y
2.2 V ±1.0%	S-1135D22-U5T1x	S-1135D22-M5T1y	S-1135D22-A6T1y
2.3 V ±1.0%	S-1135D23-U5T1x	S-1135D23-M5T1y	S-1135D23-A6T1y
2.4 V ±1.0%	S-1135D24-U5T1x	S-1135D24-M5T1y	S-1135D24-A6T1y
2.5 V ±1.0%	S-1135D25-U5T1x	S-1135D25-M5T1y	S-1135D25-A6T1y
2.6 V ±1.0%	S-1135D26-U5T1x	S-1135D26-M5T1y	S-1135D26-A6T1y
2.7 V ±1.0%	S-1135D27-U5T1x	S-1135D27-M5T1y	S-1135D27-A6T1y
2.8 V ±1.0%	S-1135D28-U5T1x	S-1135D28-M5T1y	S-1135D28-A6T1y
2.85 V ±1.0%	S-1135D2J-U5T1x	S-1135D2J-M5T1y	S-1135D2J-A6T1y
2.9 V ±1.0%	S-1135D29-U5T1x	S-1135D29-M5T1y	S-1135D29-A6T1y
3.0 V ±1.0%	S-1135D30-U5T1x	S-1135D30-M5T1y	S-1135D30-A6T1y
3.1 V ±1.0%	S-1135D31-U5T1x	S-1135D31-M5T1y	S-1135D31-A6T1y
3.2 V ±1.0%	S-1135D32-U5T1x	S-1135D32-M5T1y	S-1135D32-A6T1y
3.3 V ±1.0%	S-1135D33-U5T1x	S-1135D33-M5T1y	S-1135D33-A6T1y
3.4 V ±1.0%	S-1135D34-U5T1x	S-1135D34-M5T1y	S-1135D34-A6T1y
3.5 V ±1.0%	S-1135D35-U5T1x	S-1135D35-M5T1y	S-1135D35-A6T1y

- Remark 1.** Please contact our sales office for products with specifications other than the above.  
 2. x: G or U  
    y: S or U  
 3. Please select products of environmental code = U for Sn 100%, halogen-free products.

■ Pin Configuration



Figure 9

**Table 6**

Pin No.	Symbol	Description
1	VOUT	Output voltage pin
2	VSS	GND pin
3	NC <sup>*1</sup>	No connection
4	ON / OFF	ON / OFF pin
5	VIN	Input voltage pin

\*1. The NC pin is electrically open.  
The NC pin can be connected to VIN or VSS.



Figure 10

**Table 7**

Pin No.	Symbol	Description
1	VIN	Input voltage pin
2	VSS	GND pin
3	ON / OFF	ON / OFF pin
4	NC <sup>*1</sup>	No connection
5	VOUT	Output voltage pin

\*1. The NC pin is electrically open.  
The NC pin can be connected to VIN or VSS.



\*1. Connect the heatsink of backside at shadowed area to the board, and set electric potential open or GND.  
However, do not use it as the function of electrode.

Figure 11

**Table 8**

Pin No.	Symbol	Description
1	VOUT	Output voltage pin
2	VSS	GND pin
3	NC <sup>*1</sup>	No connection
4	ON / OFF	ON / OFF pin
5	NC <sup>*1</sup>	No connection
6	VIN	Input voltage pin

\*1. The NC pin is electrically open.  
The NC pin can be connected to VIN or VSS.

■ Absolute Maximum Ratings

Table 9

(Ta = 25°C unless otherwise specified)

Item	Symbol	Absolute Maximum Rating	Unit
Input voltage	$V_{IN}$	$V_{SS} - 0.3$ to $V_{SS} + 6.0$	V
	$V_{ON/OFF}$	$V_{SS} - 0.3$ to $V_{IN} + 0.3$	V
Output voltage	$V_{OUT}$	$V_{SS} - 0.3$ to $V_{IN} + 0.3$	V
Power dissipation	$P_D$	$1000^{*1}$	mW
		$600^{*1}$	mW
		$1000^{*2}$	mW
Operating ambient temperature	$T_{opr}$	-40 to +85	°C
Storage temperature	$T_{stg}$	-40 to +125	°C

\*1. When mounted on board

[Mounted board]

- (1) Board size : 114.3 mm × 76.2 mm × t1.6 mm
- (2) Name : JEDEC STANDARD51-7

\*2. When mounted on board

[Mounted board]

- (1) Board size : 50 mm × 50 mm × t1.6 mm
- (2) Wiring ratio : 50%

**Caution** The absolute maximum ratings are rated values exceeding which the product could suffer physical damage. These values must therefore not be exceeded under any conditions.



Figure 12 Power Dissipation of Package

■ **Electrical Characteristics**

**Table 10 (1 / 2)**

(Ta = 25°C unless otherwise specified)

Item	Symbol	Conditions	Min.	Typ.	Max.	Unit	Test Circuit	
Output voltage*1	V <sub>OUT(E)</sub>	V <sub>IN</sub> = V <sub>OUT(S)</sub> + 1.0 V, I <sub>OUT</sub> = 100 mA	1.0 V ≤ V <sub>OUT(S)</sub> < 1.5 V	V <sub>OUT(S)</sub> − 0.015	V <sub>OUT(S)</sub>	V <sub>OUT(S)</sub> + 0.015	V	1
			1.5 V ≤ V <sub>OUT(S)</sub> ≤ 3.5 V	V <sub>OUT(S)</sub> × 0.99	V <sub>OUT(S)</sub>	V <sub>OUT(S)</sub> × 1.01	V	1
Output current*2	I <sub>OUT</sub>	V <sub>IN</sub> ≥ V <sub>OUT(S)</sub> + 1.0 V	300 <sup>5</sup>	—	—	mA	3	
Dropout voltage*3	V <sub>drop</sub>	I <sub>OUT</sub> = 300 mA	1.0 V ≤ V <sub>OUT(S)</sub> < 1.1 V	0.50	0.61	0.72	V	1
			1.1 V ≤ V <sub>OUT(S)</sub> < 1.2 V	—	0.49	0.61	V	1
			1.2 V ≤ V <sub>OUT(S)</sub> < 1.3 V	—	0.38	0.53	V	1
			1.3 V ≤ V <sub>OUT(S)</sub> < 1.4 V	—	0.31	0.47	V	1
			1.4 V ≤ V <sub>OUT(S)</sub> < 1.5 V	—	0.27	0.41	V	1
			1.5 V ≤ V <sub>OUT(S)</sub> < 2.0 V	—	0.25	0.38	V	1
			2.0 V ≤ V <sub>OUT(S)</sub> < 2.6 V	—	0.21	0.32	V	1
2.6 V ≤ V <sub>OUT(S)</sub> ≤ 3.5 V	—	0.16	0.26	V	1			
Line regulation	$\frac{\Delta V_{OUT1}}{\Delta V_{IN} \bullet V_{OUT}}$	1.6 V ≤ V <sub>IN</sub> ≤ 5.5 V, I <sub>OUT</sub> = 100 mA	1.0 V ≤ V <sub>OUT(S)</sub> < 1.1 V	—	0.05	0.2	%/V	1
		V <sub>OUT(S)</sub> + 0.5 V ≤ V <sub>IN</sub> ≤ 5.5 V, I <sub>OUT</sub> = 100 mA	1.1 V ≤ V <sub>OUT(S)</sub> ≤ 3.5 V	—	0.05	0.2	%/V	1
Load regulation	ΔV <sub>OUT2</sub>	V <sub>IN</sub> = V <sub>OUT(S)</sub> + 1.0 V, 1.0 mA ≤ I <sub>OUT</sub> ≤ 150 mA	1.0 V ≤ V <sub>OUT(S)</sub> ≤ 2.0 V	—	15	20	mV	1
			2.0 V < V <sub>OUT(S)</sub> ≤ 3.5 V	—	15	25	mV	1
		V <sub>IN</sub> = V <sub>OUT(S)</sub> + 1.0 V, 1.0 mA ≤ I <sub>OUT</sub> ≤ 300 mA	1.0 V ≤ V <sub>OUT(S)</sub> ≤ 3.0 V	—	30	40	mV	1
			3.0 V < V <sub>OUT(S)</sub> ≤ 3.5 V	—	30	45	mV	1
Output voltage temperature coefficient*4	$\frac{\Delta V_{OUT}}{\Delta T_a \bullet V_{OUT}}$	V <sub>IN</sub> = V <sub>OUT(S)</sub> + 1.0 V, I <sub>OUT</sub> = 100 mA, −40°C ≤ Ta ≤ +85°C	—	±130	—	ppm/°C	1	
Current consumption during operation	I <sub>SS1</sub>	V <sub>IN</sub> = V <sub>OUT(S)</sub> + 1.0 V, ON / OFF pin = ON, no load	—	45	65	μA	2	
Current consumption during power-off	I <sub>SS2</sub>	V <sub>IN</sub> = V <sub>OUT(S)</sub> + 1.0 V, ON / OFF pin = OFF, no load	—	0.1	1.0	μA	2	
Input voltage	V <sub>IN</sub>	—	1.5	—	5.5	V	—	
ON / OFF pin input voltage "H"	V <sub>SH</sub>	V <sub>IN</sub> = V <sub>OUT(S)</sub> + 1.0 V, R <sub>L</sub> = 1.0 kΩ determined by V <sub>OUT</sub> output level	1.0	—	—	V	4	
ON / OFF pin input voltage "L"	V <sub>SL</sub>	V <sub>IN</sub> = V <sub>OUT(S)</sub> + 1.0 V, R <sub>L</sub> = 1.0 kΩ determined by V <sub>OUT</sub> output level	—	—	0.3	V	4	
ON / OFF pin input current "H"	I <sub>SH</sub>	V <sub>IN</sub> = 5.5 V, V <sub>ON/OFF</sub> = 5.5 V	B / D / E / F / G / H type	−0.1	—	0.1	μA	4
			A / C type	1.0	2.5	5.0	μA	4
ON / OFF pin input current "L"	I <sub>SL</sub>	V <sub>IN</sub> = 5.5 V, V <sub>ON/OFF</sub> = 0 V	A / B / C / D / F / H type	−0.1	—	0.1	μA	4
			E / G type	1.0	2.5	5.0	μA	4
Ripple rejection	RR	V <sub>IN</sub> = V <sub>OUT(S)</sub> + 1.0 V, f = 1.0 kHz, ΔV <sub>rip</sub> = 0.5 Vrms, I <sub>OUT</sub> = 50 mA	1.0 V ≤ V <sub>OUT(S)</sub> ≤ 1.2 V	—	70	—	dB	5
			1.2 V < V <sub>OUT(S)</sub> ≤ 3.5 V	—	65	—	dB	5
Short-circuit current	I <sub>short</sub>	V <sub>IN</sub> = V <sub>OUT(S)</sub> + 1.0 V, ON / OFF pin = ON, V <sub>OUT</sub> = 0 V	—	100	—	mA	3	

**Table 10 (2 / 2)**

S-1135 Series A / B / E / F type (With discharge shunt function)

Item	Symbol	Conditions	Min.	Typ.	Max.	Unit	Test Circuit
"L" output Nch ON resistance	R <sub>LOW</sub>	V <sub>OUT</sub> = 0.1 V, V <sub>IN</sub> = 5.5 V	—	35	—	Ω	3

S-1135 Series A / C / E / G type (With pull-up / pull-down resistor)

Item	Symbol	Conditions	Min.	Typ.	Max.	Unit	Test Circuit
Power-off pull-up / pull-down resistor	R <sub>PD</sub>	—	1.0	2.2	5.0	MΩ	4

\*1. V<sub>OUT(S)</sub>: Specified output voltage

V<sub>OUT(E)</sub>: Actual output voltage

Output voltage when fixing I<sub>OUT</sub>(= 100 mA) and inputting V<sub>OUT(S)</sub> + 1.0 V

\*2. The output current at which the output voltage becomes 95% of V<sub>OUT(E)</sub> after gradually increasing the output current.

\*3. V<sub>drop</sub> = V<sub>IN1</sub> - (V<sub>OUT3</sub> × 0.98)

V<sub>OUT3</sub> is the output voltage when V<sub>IN</sub> = V<sub>OUT(S)</sub> + 1.0 V and I<sub>OUT</sub> = 300 mA.

V<sub>IN1</sub> is the input voltage at which the output voltage becomes 98% of V<sub>OUT3</sub> after gradually decreasing the input voltage.

\*4. The change in temperature [mV/°C] is calculated using the following equation.

$$\frac{\Delta V_{OUT}}{\Delta T_a} [\text{mV}/^\circ\text{C}]^{*1} = V_{OUT(S)} [\text{V}]^{*2} \times \frac{\Delta V_{OUT}}{\Delta T_a \bullet V_{OUT}} [\text{ppm}/^\circ\text{C}]^{*3} \div 1000$$

\*1. Change in temperature of the output voltage

\*2. Specified output voltage

\*3. Output voltage temperature coefficient

\*5. The output current can be at least this value.

Due to restrictions on the package power dissipation, this value may not be satisfied. Attention should be paid to the power dissipation of the package when the output current is large.

This specification is guaranteed by design.

■ **Test Circuits**

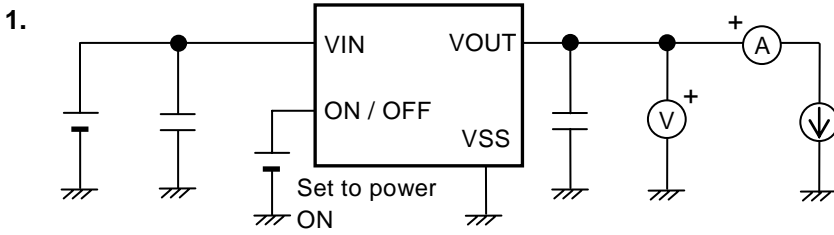

**Figure 13**



**Figure 14**



**Figure 15**

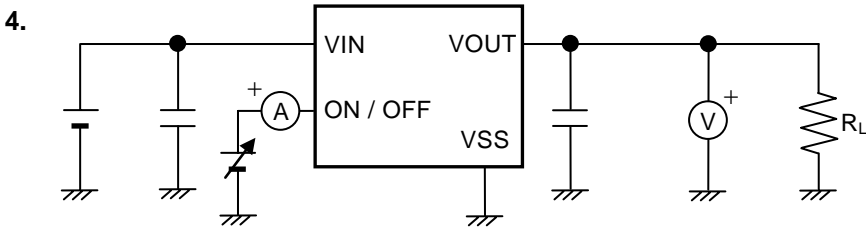

**Figure 16**

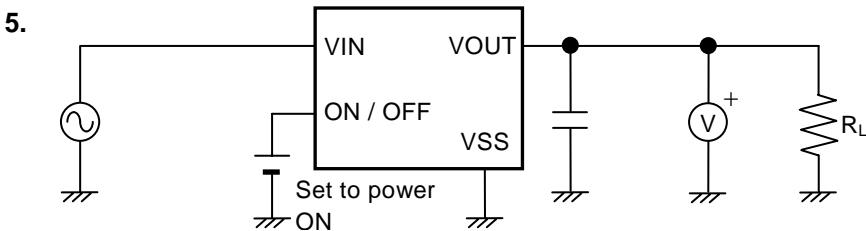

**Figure 17**



## ■ Standard Circuit



- \*1.  $C_{IN}$  is a capacitor for stabilizing the input.
- \*2. Ceramic capacitor of  $1.0 \mu\text{F}$  or more can be used as  $C_L$ .

Figure 18

**Caution** The above connection diagram and constant will not guarantee successful operation. Perform thorough evaluation using the actual application to set the constant.

## ■ Condition of Application

Input capacitor ( $C_{IN}$ ) :  $1.0 \mu\text{F}$  or more  
 Output capacitor ( $C_L$ ) :  $1.0 \mu\text{F}$  or more (ceramic capacitor)

**Caution** A general series regulator may oscillate, depending on the external components. Confirm that no oscillation occurs in the application for which the above capacitors are used.

## ■ Selection of Input and Output Capacitors ( $C_{IN}$ , $C_L$ )

The S-1135 Series requires an output capacitor between the VOUT and VSS pin for phase compensation. Operation is stabilized by a ceramic capacitor with an output capacitance of  $1.0 \mu\text{F}$  or more over the entire temperature range. When using an OS capacitor, tantalum capacitor, or aluminum electrolytic capacitor, the capacitance must be  $1.0 \mu\text{F}$  or more.

The value of the output overshoot or undershoot transient response varies depending on the value of the output capacitor. The required capacitance of the input capacitor differs depending on the application.

The recommended capacitance for an application is  $C_{IN} \geq 1.0 \mu\text{F}$ ,  $C_L \geq 1.0 \mu\text{F}$ ; however, when selecting the output capacitor, perform sufficient evaluation, including evaluation of temperature characteristics, on the actual device.

## ■ Explanation of Terms

### 1. Low dropout voltage regulator

This IC's voltage regulator has the low dropout voltage due to its built-in low on-resistance transistor.

### 2. Output voltage ( $V_{OUT}$ )

The accuracy of the output voltage is ensured at  $\pm 1.0\%$  or  $\pm 15 \text{ mV}^*1$  under the specified conditions of fixed input voltage<sup>\*2</sup>, fixed output current, and fixed temperature.

\*1. When  $V_{OUT} < 1.5 \text{ V}$  :  $\pm 15 \text{ mV}$ , When  $1.5 \text{ V} \leq V_{OUT}$  :  $\pm 1.0\%$

\*2. Differs depending on the product.

**Caution** If the above conditions change, the output voltage value may vary and exceed the accuracy range of the output voltage. Refer to “■ Electrical Characteristics” and “■ Characteristics (Typical Data)” for details.

### 3. Line regulation $\left( \frac{\Delta V_{OUT1}}{\Delta V_{IN} \bullet V_{OUT}} \right)$

Indicates the dependency of the output voltage on the input voltage. That is, the values show how much the output voltage changes due to a change in the input voltage with the output current remaining unchanged.

### 4. Load regulation ( $\Delta V_{OUT2}$ )

Indicates the dependency of the output voltage on the output current. That is, the values show how much the output voltage changes due to a change in the output current with the input voltage remaining unchanged.

### 5. Dropout voltage ( $V_{drop}$ )

Indicates the difference between input voltage  $V_{IN}$  and the output voltage when; decreasing input voltage  $V_{IN}$  gradually until the output voltage has dropped out to the value of 98% of output voltage  $V_{OUT3}$ , which is at  $V_{IN} = V_{OUT(S)} + 1.0 \text{ V}$ .

$$V_{drop} = V_{IN1} - (V_{OUT3} \times 0.98)$$

6. Temperature coefficient of output voltage  $\left(\frac{\Delta V_{OUT}}{\Delta T_a \bullet V_{OUT}}\right)$

The shaded area in **Figure 19** is the range where  $V_{OUT}$  varies in the operating temperature range when the temperature coefficient of the output voltage is  $\pm 130$  ppm/ $^{\circ}\text{C}$ .

Example of S-1135B30 typ. products



\*1.  $V_{OUT(E)}$  is the value of the output voltage measured at 25°C.

**Figure 19**

A change in the temperature of the output voltage [mV/ $^{\circ}\text{C}$ ] is calculated using the following equation.

$$\frac{\Delta V_{OUT}}{\Delta T_a} [\text{mV}/^{\circ}\text{C}]^{*1} = V_{OUT(S)} [\text{V}]^{*2} \times \frac{\Delta V_{OUT}}{\Delta T_a \bullet V_{OUT}} [\text{ppm}/^{\circ}\text{C}]^{*3} \div 1000$$

- \*1. Change in temperature of output voltage
- \*2. Specified output voltage
- \*3. Output voltage temperature coefficient

■ **Operation**

1. **Basic operation**

**Figure 20** shows the block diagram of S-1135 Series.

The error amplifier compares the reference voltage ( $V_{ref}$ ) with  $V_{fb}$ , which is the output voltage resistance-divided by feedback resistors  $R_s$  and  $R_f$ . It supplies the gate voltage necessary to maintain the constant output voltage which is not influenced by the input voltage and temperature change, to the output transistor.



\*1. Parasitic diode

**Figure 20**

2. **Output transistor**

In the S-1135 Series, a low on-resistance P-channel MOS FET is used as the output transistor.

Be sure that  $V_{OUT}$  does not exceed  $V_{IN} + 0.3$  V to prevent the voltage regulator from being damaged due to inverse current flowing from the VOUT pin through a parasitic diode to the VIN pin.

### 3. ON / OFF pin

This pin starts and stops the regulator.

When the ON / OFF pin is set to the power-off level, the entire internal circuit stops operating, and the built-in P-channel MOS FET output transistor between the VIN and VOUT pins is turned off, reducing current consumption significantly.

Since the S-1135 Series A / B / E / F types have a built-in discharge shunt circuit to discharge the output capacitance, the VOUT pin is forcibly set to  $V_{SS}$  level. In the S-1135 Series C / D / G / H types, the VOUT pin is set to  $V_{SS}$  level through several hundred  $k\Omega$  internal divided resistors between the VOUT and  $V_{SS}$  pins. Note that the current consumption increases when a voltage of 0.3 V to 1.0 V ( $T_a = 25^\circ\text{C}$ ) is applied to the ON / OFF pin.

The ON / OFF pin is configured as shown in **Figures 21** and **22**. In the S-1135 Series A / C / E / G types, the ON / OFF pin is internally pulled up or pulled down to  $V_{SS}$  when in the floating status, so the VOUT pin is set to the  $V_{SS}$  level. In the S-1135 Series B / D / F / H types, the ON / OFF pin is not internally pulled up or pulled down, so do not use these types with the ON / OFF pin in the floating status. When the ON / OFF pin is not used in the S-1135 Series B / D / F / H types, connect the pin to the VIN pin in the B / D types, and connect it to the  $V_{SS}$  pin in the F / H types.

Table 11

Logic Type	ON / OFF Pin	Internal Circuits	VOUT Pin Voltage	Current Consumption
A / B / C / D	"H": Power-on	Operating	Set value	$I_{SS1}$ <sup>*1</sup>
A / B / C / D	"L": Power-off	Stopped	$V_{SS}$ level	$I_{SS2}$
E / F / G / H	"H": Power-off	Stopped	$V_{SS}$ level	$I_{SS2}$
E / F / G / H	"L": Power-on	Operating	Set value	$I_{SS1}$ <sup>*1</sup>

\*1. Note that the IC's current consumption increases as much as current flows into the pull-up / pull-down resistor when; the ON / OFF pin is connected to VIN in the A / C type, the ON / OFF pin is connected to  $V_{SS}$  in the E / G type (**Figure 21**).

(1) S-1135 Series A / C / E / G Type



Figure 21

(2) S-1135 Series B / D / F / H Type



Figure 22

**4. Discharge shunt function (S-1135 Series A / B / E / F types)**

The S-1135 Series A / B / E / F types have a built-in discharge shunt circuit to discharge the output capacitance. When the ON / OFF pin is set to power-off level, turns the output transistor off, and turns the discharge shunt function on so that the output capacitor discharges. These types allow for the VOUT pin reach the  $V_{SS}$  level faster than the S-1135 Series C / D / G / H types that does not have a discharge shunt circuit.



**Figure 23**

## 5. Overcurrent protection circuit

The S-1135 Series has an overcurrent protection circuit having the characteristics shown in “(1) Output Voltage vs. Output Current (When Load Current Increases) (Ta = 25°C)” in “■ Characteristics (Typical Data)”, in order to protect the output transistor against an excessive output current and short circuiting between the VOUT and VSS pins. The current ( $I_{short}$ ) when the output pin is short-circuited is internally set at approx. 100 mA (typ.), and the normal value is restored for the output voltage, if releasing a short circuit once.

**Caution** Using the overcurrent protection circuit is to protect the output transistor from accidental conditions such as short circuited load and the rapid and large current flow in the large capacitor. The overcurrent protection circuit is not suitable for use under the short circuit status or large current flowing (300 mA or more) that last long.

## 6. Pull-down / pull-up resistor (S-1135 Series A / C / E / G types)

In the S-1135 Series A / C / E / G types, the ON / OFF pin is internally pulled up to VIN or pulled down to VSS, so the VOUT pin is in the  $V_{SS}$  level when in the floating status.

Note that the IC's current consumption increases as much as current flows into the pull-up / pull-down resistor of 2.2 M $\Omega$  (typ.) when; the ON / OFF pin is connected to VIN in the A / C type, the ON / OFF pin is connected to VSS in the E / G type.

## ■ Precautions

- Wiring patterns for the VIN, VOUT and GND pins should be designed so that the impedance is low. When mounting an output capacitor between the VOUT and VSS pin ( $C_L$ ) and a capacitor for stabilizing the input between VIN and VSS pin ( $C_{IN}$ ), the distance from the capacitors to these pins should be as short as possible.
- Note that the output voltage may increase when a series regulator is used at low load current (1.0 mA or less).
- Note that the output voltage may increase due to the leakage current from a driver when a series regulator is used at high temperature.
- Generally a series regulator may cause oscillation, depending on the selection of external parts. The following conditions are recommended for this IC. However, be sure to perform sufficient evaluation under the actual usage conditions for selection, including evaluation of temperature characteristics. See “(5) Example of Equivalent Series Resistance vs. Output Current Characteristics ( $T_a = 25^\circ\text{C}$ )” in “■ Reference Data” for the equivalent series resistance ( $R_{ESR}$ ) of the output capacitor.

Input capacitor ( $C_{IN}$ ) : 1.0  $\mu\text{F}$  or more  
Output capacitor ( $C_L$ ) : 1.0  $\mu\text{F}$  or more

- The voltage regulator may oscillate when the impedance of the power supply is high and the input capacitor is small or an input capacitor is not connected.
- If the output capacitance is small, power supply's fluctuation and the characteristics of load fluctuation become worse. Sufficiently evaluate the output voltage's fluctuation with the actual device.
- A momentary overshoot may be output when the power supply suddenly increases, and the output capacitance is small. It is therefore important to sufficiently evaluate the output voltage at power application in actual device.
- The application conditions for the input voltage, output voltage, and load current should not exceed the package power dissipation.
- Do not apply an electrostatic discharge to this IC that exceeds the performance ratings of the built-in electrostatic protection circuit.
- In determining the output current, attention should be paid to the output current value specified in **Table 10** in “■ Electrical Characteristics” and footnote \*5 of the table.
- SII claims no responsibility for any disputes arising out of or in connection with any infringement by products including this IC of patents owned by a third party.



■ Characteristics (Typical Data)

(1) Output Voltage vs. Output Current (When Load Current Increases) (Ta = 25°C)



**Remark** In determining the output current, attention should be paid to the following.

1. The minimum output current value and footnote \*5 in Table 10 in the "■ Electrical Characteristics"
2. The package power dissipation

(2) Output Voltage vs. Input Voltage (Ta = 25°C)

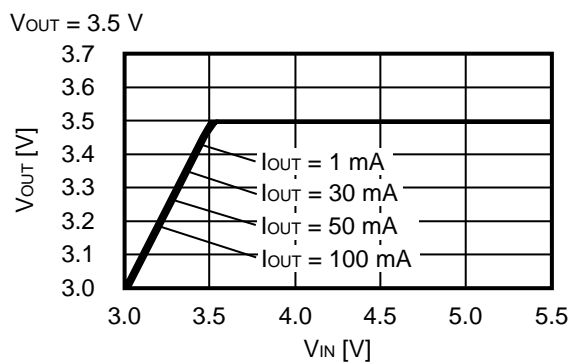
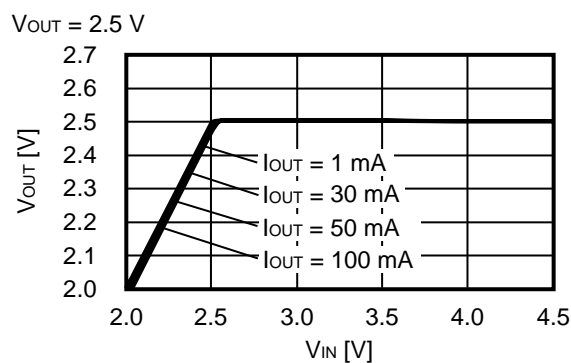

**(3) Dropout Voltage vs. Output Current**



**(4) Dropout Voltage vs. Set Output Voltage**

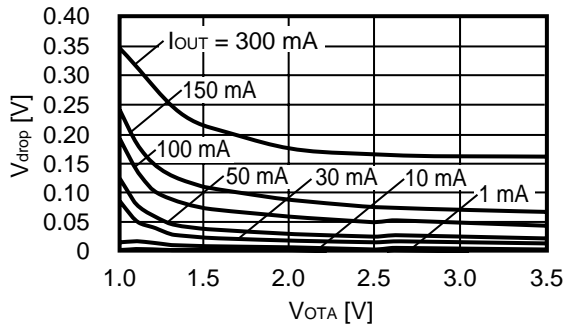

(5) Output Voltage vs. Ambient Temperature

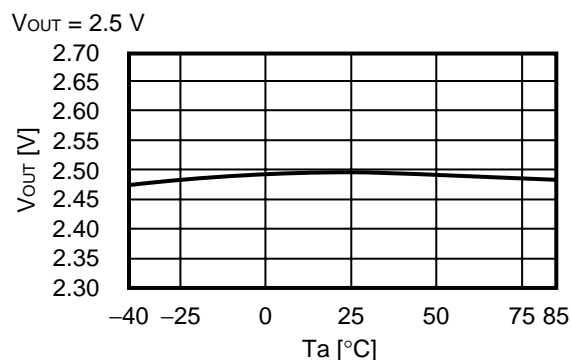
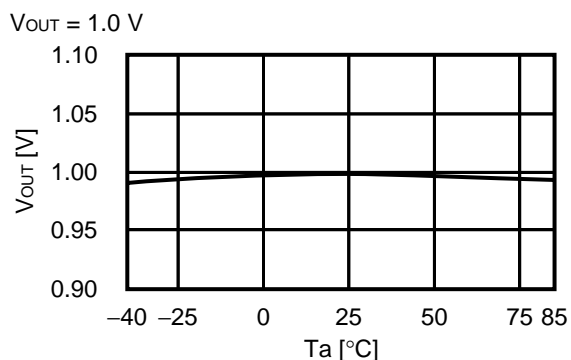

(6) Current Consumption vs. Input Voltage



**(7) Ripple Rejection ( $T_a = 25^\circ\text{C}$ )**

$V_{OUT} = 1.0\text{ V}$



$V_{OUT} = 2.5\text{ V}$



$V_{OUT} = 3.5\text{ V}$



■ Reference Data

(1) Transient Response Characteristics when Input (Ta = 25°C)

V<sub>OUT</sub> = 1.0 V

I<sub>OUT</sub> = 100 mA, tr = tf = 5.0 μs, C<sub>L</sub> = 1.0 μF



V<sub>OUT</sub> = 2.5 V

I<sub>OUT</sub> = 100 mA, tr = tf = 5.0 μs, C<sub>L</sub> = 1.0 μF



V<sub>OUT</sub> = 3.5 V

I<sub>OUT</sub> = 100 mA, tr = tf = 5.0 μs, C<sub>L</sub> = 1.0 μF



(2) Transient Response Characteristics of Load (Ta = 25°C)

V<sub>OUT</sub> = 1.0 V

V<sub>IN</sub> = 2.0 V, C<sub>L</sub> = 1.0 μF, C<sub>IN</sub> = 1.0 μF, I<sub>OUT</sub> = 50 ↔ 100 mA



V<sub>OUT</sub> = 2.5 V

V<sub>IN</sub> = 3.5 V, C<sub>L</sub> = 1.0 μF, C<sub>IN</sub> = 1.0 μF, I<sub>OUT</sub> = 50 ↔ 100 mA



V<sub>OUT</sub> = 3.5 V

V<sub>IN</sub> = 4.5 V, C<sub>L</sub> = 1.0 μF, C<sub>IN</sub> = 1.0 μF, I<sub>OUT</sub> = 50 ↔ 100 mA



**(3) Transient Response Characteristics of ON / OFF Pin (Ta = 25°C)**

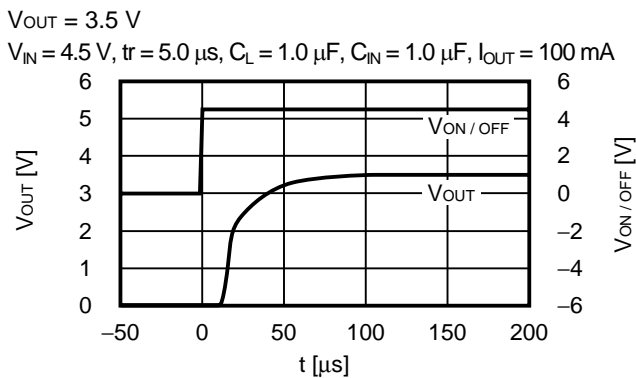
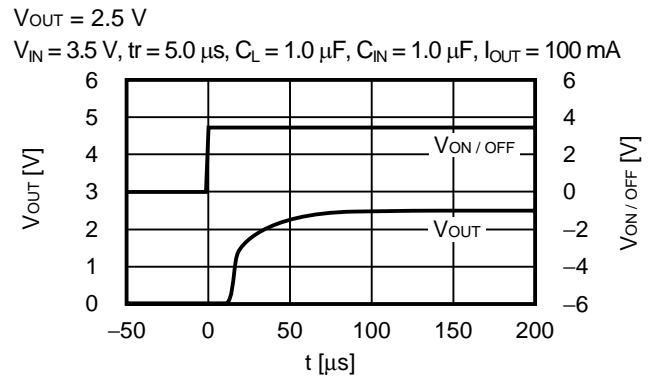
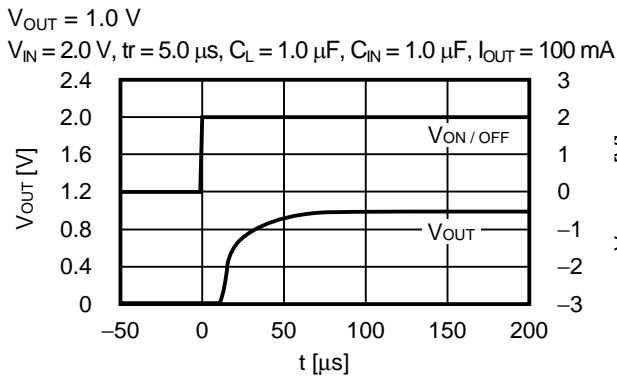

**(4) Output Capacitance vs. Characteristics of Discharge Time (Ta = 25°C)**  
**S-1135 Series A / B type (with discharge shunt function)**

$V_{IN} = V_{OUT} + 1.0\text{ V}$ ,  $I_{OUT} = \text{no load}$   
 $V_{ON/OFF} = V_{OUT} + 1.0\text{ V} \rightarrow V_{SS}$ ,  $t_f = 1\ \mu\text{s}$

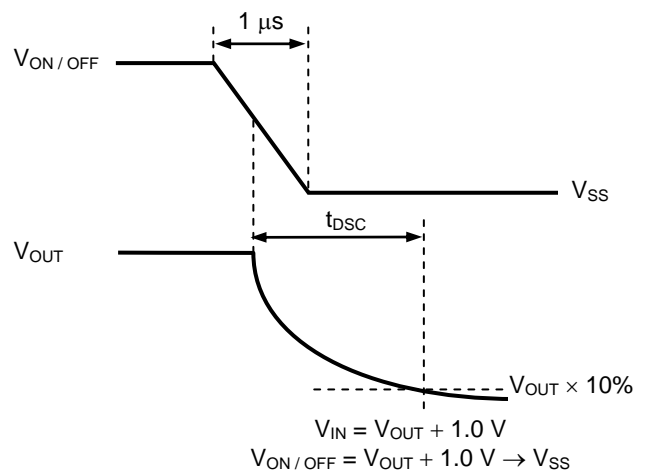
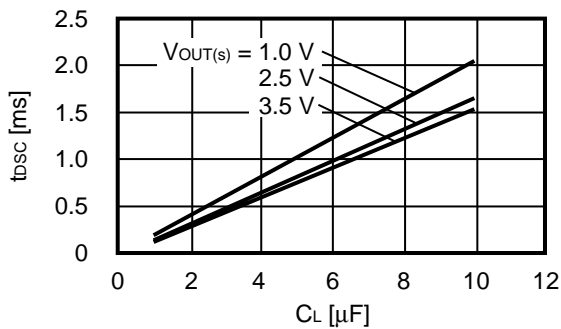

**Figure 24 Measurement Condition of Discharge Time**

(5) Example of Equivalent Series Resistance vs. Output Current Characteristics ( $T_a = 25^\circ\text{C}$ )

$C_L$  : TAIYO YUDEN TMK316BJ105KD (1.0  $\mu\text{F}$ )



■ Marking Specifications

(1) SOT-89-5



(1) to (3) : Product code (Refer to **Product name vs. Product code**)  
(4) to (6) : Lot number

Product name vs. Product code

(a) S-1135 Series A type

Product Name	Product code		
	(1)	(2)	(3)
S-1135A10-U5T1x	S	E	A
S-1135A11-U5T1x	S	E	B
S-1135A12-U5T1x	S	E	C
S-1135A13-U5T1x	S	E	D
S-1135A14-U5T1x	S	E	E
S-1135A15-U5T1x	S	E	F
S-1135A16-U5T1x	S	E	G
S-1135A17-U5T1x	S	E	H
S-1135A18-U5T1x	S	E	I
S-1135A1J-U5T1x	S	E	J
S-1135A19-U5T1x	S	E	K
S-1135A20-U5T1x	S	E	L
S-1135A21-U5T1x	S	E	M
S-1135A22-U5T1x	S	E	N
S-1135A23-U5T1x	S	E	O
S-1135A24-U5T1x	S	E	P
S-1135A25-U5T1x	S	E	Q
S-1135A26-U5T1x	S	E	R
S-1135A27-U5T1x	S	E	S
S-1135A28-U5T1x	S	E	T
S-1135A2J-U5T1x	S	E	U
S-1135A29-U5T1x	S	E	V
S-1135A30-U5T1x	S	E	W
S-1135A31-U5T1x	S	E	X
S-1135A32-U5T1x	S	E	Y
S-1135A33-U5T1x	S	E	Z
S-1135A34-U5T1x	S	E	2
S-1135A10-U5T1x	S	E	3

(b) S-1135 Series B type

Product Name	Product code		
	(1)	(2)	(3)
S-1135B10-U5T1x	S	G	A
S-1135B11-U5T1x	S	G	B
S-1135B12-U5T1x	S	G	C
S-1135B13-U5T1x	S	G	D
S-1135B14-U5T1x	S	G	E
S-1135B15-U5T1x	S	G	F
S-1135B16-U5T1x	S	G	G
S-1135B17-U5T1x	S	G	H
S-1135B18-U5T1x	S	G	I
S-1135B1J-U5T1x	S	G	J
S-1135B19-U5T1x	S	G	K
S-1135B20-U5T1x	S	G	L
S-1135B21-U5T1x	S	G	M
S-1135B22-U5T1x	S	G	N
S-1135B23-U5T1x	S	G	O
S-1135B24-U5T1x	S	G	P
S-1135B25-U5T1x	S	G	Q
S-1135B26-U5T1x	S	G	R
S-1135B27-U5T1x	S	G	S
S-1135B28-U5T1x	S	G	T
S-1135B2J-U5T1x	S	G	U
S-1135B29-U5T1x	S	G	V
S-1135B30-U5T1x	S	G	W
S-1135B31-U5T1x	S	G	X
S-1135B32-U5T1x	S	G	Y
S-1135B33-U5T1x	S	G	Z
S-1135B34-U5T1x	S	G	2
S-1135B35-U5T1x	S	G	3

**Remark 1.** Please contact our sales office for products with specifications other than the above.

2. x: G or U

3. Please select products of environmental code = U for Sn 100%, halogen-free products.



# HIGH RIPPLE-REJECTION LOW DROPOUT MIDDLE OUTPUT CURRENT CMOS VOLTAGE REGULATOR

Rev.2.0\_00

**S-1135 Series**

**(c) S-1135 Series C type**

Product Name	Product code		
	(1)	(2)	(3)
S-1135C10-U5T1x	V	A	A
S-1135C11-U5T1x	V	A	B
S-1135C12-U5T1x	V	A	C
S-1135C13-U5T1x	V	A	D
S-1135C14-U5T1x	V	A	E
S-1135C15-U5T1x	V	A	F
S-1135C16-U5T1x	V	A	G
S-1135C17-U5T1x	V	A	H
S-1135C18-U5T1x	V	A	I
S-1135C1J-U5T1x	V	A	J
S-1135C19-U5T1x	V	A	K
S-1135C20-U5T1x	V	A	L
S-1135C21-U5T1x	V	A	M
S-1135C22-U5T1x	V	A	N
S-1135C23-U5T1x	V	A	O
S-1135C24-U5T1x	V	A	P
S-1135C25-U5T1x	V	A	Q
S-1135C26-U5T1x	V	A	R
S-1135C27-U5T1x	V	A	S
S-1135C28-U5T1x	V	A	T
S-1135C2J-U5T1x	V	A	U
S-1135C29-U5T1x	V	A	V
S-1135C30-U5T1x	V	A	W
S-1135C31-U5T1x	V	A	X
S-1135C32-U5T1x	V	A	Y
S-1135C33-U5T1x	V	A	Z
S-1135C34-U5T1x	V	A	2
S-1135C35-U5T1x	V	A	3

**(d) S-1135 Series D type**

Product Name	Product code		
	(1)	(2)	(3)
S-1135D10-U5T1x	V	B	A
S-1135D11-U5T1x	V	B	B
S-1135D12-U5T1x	V	B	C
S-1135D13-U5T1x	V	B	D
S-1135D14-U5T1x	V	B	E
S-1135D15-U5T1x	V	B	F
S-1135D16-U5T1x	V	B	G
S-1135D17-U5T1x	V	B	H
S-1135D18-U5T1x	V	B	I
S-1135D1J-U5T1x	V	B	J
S-1135D19-U5T1x	V	B	K
S-1135D20-U5T1x	V	B	L
S-1135D21-U5T1x	V	B	M
S-1135D22-U5T1x	V	B	N
S-1135D23-U5T1x	V	B	O
S-1135D24-U5T1x	V	B	P
S-1135D25-U5T1x	V	B	Q
S-1135D26-U5T1x	V	B	R
S-1135D27-U5T1x	V	B	S
S-1135D28-U5T1x	V	B	T
S-1135D2J-U5T1x	V	B	U
S-1135D29-U5T1x	V	B	V
S-1135D30-U5T1x	V	B	W
S-1135D31-U5T1x	V	B	X
S-1135D32-U5T1x	V	B	Y
S-1135D33-U5T1x	V	B	Z
S-1135D34-U5T1x	V	B	2
S-1135D35-U5T1x	V	B	3

- Remark 1.** Please contact our sales office for products with specifications other than the above.
2. x: G or U
  3. Please select products of environmental code = U for Sn 100%, halogen-free products.

# HIGH RIPPLE-REJECTION LOW DROPOUT MIDDLE OUTPUT CURRENT CMOS VOLTAGE REGULATOR

## S-1135 Series

Rev.2.0\_00

### (2) SOT-23-5



(1) to (3) : Product code (Refer to **Product name vs. Product code**)  
 (4) : Lot number

### Product name vs. Product code

#### (a) S-1135 Series A type

Product Name	Product code		
	(1)	(2)	(3)
S-1135A10-M5T1y	S	E	A
S-1135A11-M5T1y	S	E	B
S-1135A12-M5T1y	S	E	C
S-1135A13-M5T1y	S	E	D
S-1135A14-M5T1y	S	E	E
S-1135A15-M5T1y	S	E	F
S-1135A16-M5T1y	S	E	G
S-1135A17-M5T1y	S	E	H
S-1135A18-M5T1y	S	E	I
S-1135A1J-M5T1y	S	E	J
S-1135A19-M5T1y	S	E	K
S-1135A20-M5T1y	S	E	L
S-1135A21-M5T1y	S	E	M
S-1135A22-M5T1y	S	E	N
S-1135A23-M5T1y	S	E	O
S-1135A24-M5T1y	S	E	P
S-1135A25-M5T1y	S	E	Q
S-1135A26-M5T1y	S	E	R
S-1135A27-M5T1y	S	E	S
S-1135A28-M5T1y	S	E	T
S-1135A2J-M5T1y	S	E	U
S-1135A29-M5T1y	S	E	V
S-1135A30-M5T1y	S	E	W
S-1135A31-M5T1y	S	E	X
S-1135A32-M5T1y	S	E	Y
S-1135A33-M5T1y	S	E	Z
S-1135A34-M5T1y	S	E	2
S-1135A35-M5T1y	S	E	3

#### (b) S-1135 Series B type

Product Name	Product code		
	(1)	(2)	(3)
S-1135B10-M5T1y	S	G	A
S-1135B11-M5T1y	S	G	B
S-1135B12-M5T1y	S	G	C
S-1135B13-M5T1y	S	G	D
S-1135B14-M5T1y	S	G	E
S-1135B15-M5T1y	S	G	F
S-1135B16-M5T1y	S	G	G
S-1135B17-M5T1y	S	G	H
S-1135B18-M5T1y	S	G	I
S-1135B1J-M5T1y	S	G	J
S-1135B19-M5T1y	S	G	K
S-1135B20-M5T1y	S	G	L
S-1135B21-M5T1y	S	G	M
S-1135B22-M5T1y	S	G	N
S-1135B23-M5T1y	S	G	O
S-1135B24-M5T1y	S	G	P
S-1135B25-M5T1y	S	G	Q
S-1135B26-M5T1y	S	G	R
S-1135B27-M5T1y	S	G	S
S-1135B28-M5T1y	S	G	T
S-1135B2J-M5T1y	S	G	U
S-1135B29-M5T1y	S	G	V
S-1135B30-M5T1y	S	G	W
S-1135B31-M5T1y	S	G	X
S-1135B32-M5T1y	S	G	Y
S-1135B33-M5T1y	S	G	Z
S-1135B34-M5T1y	S	G	2
S-1135B35-M5T1y	S	G	3

**Remark 1.** Please contact our sales office for products with specifications other than the above.

2. y: S or U

3. Please select products of environmental code = U for Sn 100%, halogen-free products.

# HIGH RIPPLE-REJECTION LOW DROPOUT MIDDLE OUTPUT CURRENT CMOS VOLTAGE REGULATOR

Rev.2.0\_00

**S-1135 Series**

**(c) S-1135 Series C type**

Product Name	Product code		
	(1)	(2)	(3)
S-1135C10-M5T1y	V	A	A
S-1135C11-M5T1y	V	A	B
S-1135C12-M5T1y	V	A	C
S-1135C13-M5T1y	V	A	D
S-1135C14-M5T1y	V	A	E
S-1135C15-M5T1y	V	A	F
S-1135C16-M5T1y	V	A	G
S-1135C17-M5T1y	V	A	H
S-1135C18-M5T1y	V	A	I
S-1135C1J-M5T1y	V	A	J
S-1135C19-M5T1y	V	A	K
S-1135C20-M5T1y	V	A	L
S-1135C21-M5T1y	V	A	M
S-1135C22-M5T1y	V	A	N
S-1135C23-M5T1y	V	A	O
S-1135C24-M5T1y	V	A	P
S-1135C25-M5T1y	V	A	Q
S-1135C26-M5T1y	V	A	R
S-1135C27-M5T1y	V	A	S
S-1135C28-M5T1y	V	A	T
S-1135C2J-M5T1y	V	A	U
S-1135C29-M5T1y	V	A	V
S-1135C30-M5T1y	V	A	W
S-1135C31-M5T1y	V	A	X
S-1135C32-M5T1y	V	A	Y
S-1135C33-M5T1y	V	A	Z
S-1135C34-M5T1y	V	A	2
S-1135C35-M5T1y	V	A	3

**(d) S-1135 Series D type**

Product Name	Product code		
	(1)	(2)	(3)
S-1135D10-M5T1y	V	B	A
S-1135D11-M5T1y	V	B	B
S-1135D12-M5T1y	V	B	C
S-1135D13-M5T1y	V	B	D
S-1135D14-M5T1y	V	B	E
S-1135D15-M5T1y	V	B	F
S-1135D16-M5T1y	V	B	G
S-1135D17-M5T1y	V	B	H
S-1135D18-M5T1y	V	B	I
S-1135D1J-M5T1y	V	B	J
S-1135D19-M5T1y	V	B	K
S-1135D20-M5T1y	V	B	L
S-1135D21-M5T1y	V	B	M
S-1135D22-M5T1y	V	B	N
S-1135D23-M5T1y	V	B	O
S-1135D24-M5T1y	V	B	P
S-1135D25-M5T1y	V	B	Q
S-1135D26-M5T1y	V	B	R
S-1135D27-M5T1y	V	B	S
S-1135D28-M5T1y	V	B	T
S-1135D2J-M5T1y	V	B	U
S-1135D29-M5T1y	V	B	V
S-1135D30-M5T1y	V	B	W
S-1135D31-M5T1y	V	B	X
S-1135D32-M5T1y	V	B	Y
S-1135D33-M5T1y	V	B	Z
S-1135D34-M5T1y	V	B	2
S-1135D35-M5T1y	V	B	3

- Remark 1.** Please contact our sales office for products with specifications other than the above.
2. y: S or U
  3. Please select products of environmental code = U for Sn 100%, halogen-free products.

# HIGH RIPPLE-REJECTION LOW DROPOUT MIDDLE OUTPUT CURRENT CMOS VOLTAGE REGULATOR

## S-1135 Series

Rev.2.0\_00

### (3) HSNT-6A

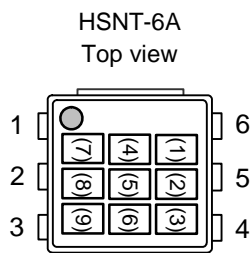

- (1) to (3) : Product code (Refer to **Product name vs. Product code**)  
 (4) : Blank  
 (5) to (9) : Lot number

### Product name vs. Product code

#### (a) S-1135 Series A type

Product Name	Product code		
	(1)	(2)	(3)
S-1135A10-A6T1y	S	E	A
S-1135A11-A6T1y	S	E	B
S-1135A12-A6T1y	S	E	C
S-1135A13-A6T1y	S	E	D
S-1135A14-A6T1y	S	E	E
S-1135A15-A6T1y	S	E	F
S-1135A16-A6T1y	S	E	G
S-1135A17-A6T1y	S	E	H
S-1135A18-A6T1y	S	E	I
S-1135A1J-A6T1y	S	E	J
S-1135A19-A6T1y	S	E	K
S-1135A20-A6T1y	S	E	L
S-1135A21-A6T1y	S	E	M
S-1135A22-A6T1y	S	E	N
S-1135A23-A6T1y	S	E	O
S-1135A24-A6T1y	S	E	P
S-1135A25-A6T1y	S	E	Q
S-1135A26-A6T1y	S	E	R
S-1135A27-A6T1y	S	E	S
S-1135A28-A6T1y	S	E	T
S-1135A2J-A6T1y	S	E	U
S-1135A29-A6T1y	S	E	V
S-1135A30-A6T1y	S	E	W
S-1135A31-A6T1y	S	E	X
S-1135A32-A6T1y	S	E	Y
S-1135A33-A6T1y	S	E	Z
S-1135A34-A6T1y	S	E	2
S-1135A35-A6T1y	S	E	3

#### (b) S-1135 Series B type

Product Name	Product code		
	(1)	(2)	(3)
S-1135B10-A6T1y	S	G	A
S-1135B11-A6T1y	S	G	B
S-1135B12-A6T1y	S	G	C
S-1135B13-A6T1y	S	G	D
S-1135B14-A6T1y	S	G	E
S-1135B15-A6T1y	S	G	F
S-1135B16-A6T1y	S	G	G
S-1135B17-A6T1y	S	G	H
S-1135B18-A6T1y	S	G	I
S-1135B1J-A6T1y	S	G	J
S-1135B19-A6T1y	S	G	K
S-1135B20-A6T1y	S	G	L
S-1135B21-A6T1y	S	G	M
S-1135B22-A6T1y	S	G	N
S-1135B23-A6T1y	S	G	O
S-1135B24-A6T1y	S	G	P
S-1135B25-A6T1y	S	G	Q
S-1135B26-A6T1y	S	G	R
S-1135B27-A6T1y	S	G	S
S-1135B28-A6T1y	S	G	T
S-1135B2J-A6T1y	S	G	U
S-1135B29-A6T1y	S	G	V
S-1135B30-A6T1y	S	G	W
S-1135B31-A6T1y	S	G	X
S-1135B32-A6T1y	S	G	Y
S-1135B33-A6T1y	S	G	Z
S-1135B34-A6T1y	S	G	2
S-1135B35-A6T1y	S	G	3

- Remark 1.** Please contact our sales office for products with specifications other than the above.  
 2. y: S or U  
 3. Please select products of environmental code = U for Sn 100%, halogen-free products.

# HIGH RIPPLE-REJECTION LOW DROPOUT MIDDLE OUTPUT CURRENT CMOS VOLTAGE REGULATOR

Rev.2.0\_00

**S-1135 Series**

**(c) S-1135 Series C type**

Product Name	Product code		
	(1)	(2)	(3)
S-1135C10-A6T1y	V	A	A
S-1135C11-A6T1y	V	A	B
S-1135C12-A6T1y	V	A	C
S-1135C13-A6T1y	V	A	D
S-1135C14-A6T1y	V	A	E
S-1135C15-A6T1y	V	A	F
S-1135C16-A6T1y	V	A	G
S-1135C17-A6T1y	V	A	H
S-1135C18-A6T1y	V	A	I
S-1135C1J-A6T1y	V	A	J
S-1135C19-A6T1y	V	A	K
S-1135C20-A6T1y	V	A	L
S-1135C21-A6T1y	V	A	M
S-1135C22-A6T1y	V	A	N
S-1135C23-A6T1y	V	A	O
S-1135C24-A6T1y	V	A	P
S-1135C25-A6T1y	V	A	Q
S-1135C26-A6T1y	V	A	R
S-1135C27-A6T1y	V	A	S
S-1135C28-A6T1y	V	A	T
S-1135C2J-A6T1y	V	A	U
S-1135C29-A6T1y	V	A	V
S-1135C30-A6T1y	V	A	W
S-1135C31-A6T1y	V	A	X
S-1135C32-A6T1y	V	A	Y
S-1135C33-A6T1y	V	A	Z
S-1135C34-A6T1y	V	A	2
S-1135C35-A6T1y	V	A	3

**(d) S-1135 Series D type**

Product Name	Product code		
	(1)	(2)	(3)
S-1135D10-A6T1y	V	B	A
S-1135D11-A6T1y	V	B	B
S-1135D12-A6T1y	V	B	C
S-1135D13-A6T1y	V	B	D
S-1135D14-A6T1y	V	B	E
S-1135D15-A6T1y	V	B	F
S-1135D16-A6T1y	V	B	G
S-1135D17-A6T1y	V	B	H
S-1135D18-A6T1y	V	B	I
S-1135D1J-A6T1y	V	B	J
S-1135D19-A6T1y	V	B	K
S-1135D20-A6T1y	V	B	L
S-1135D21-A6T1y	V	B	M
S-1135D22-A6T1y	V	B	N
S-1135D23-A6T1y	V	B	O
S-1135D24-A6T1y	V	B	P
S-1135D25-A6T1y	V	B	Q
S-1135D26-A6T1y	V	B	R
S-1135D27-A6T1y	V	B	S
S-1135D28-A6T1y	V	B	T
S-1135D2J-A6T1y	V	B	U
S-1135D29-A6T1y	V	B	V
S-1135D30-A6T1y	V	B	W
S-1135D31-A6T1y	V	B	X
S-1135D32-A6T1y	V	B	Y
S-1135D33-A6T1y	V	B	Z
S-1135D34-A6T1y	V	B	2
S-1135D35-A6T1y	V	B	3

**Remark 1.** Please contact our sales office for products with specifications other than the above.

2. y: S or U

3. Please select products of environmental code = U for Sn 100%, halogen-free products.



No. UP005-A-P-SD-1.1

TITLE	SOT895-A-PKG Dimensions
No.	UP005-A-P-SD-1.1
SCALE	
UNIT	mm
Seiko Instruments Inc.	

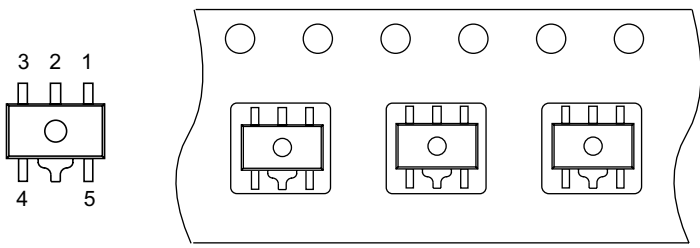

→  
Feed direction

No. UP005-A-C-SD-1.1

TITLE	SOT895-A-Carrier Tape
No.	UP005-A-C-SD-1.1
SCALE	
UNIT	mm

Seiko Instruments Inc.



Enlarged drawing in the central part



No. UP005-A-R-SD-1.1

TITLE	SOT895-A-Reel		
No.	UP005-A-R-SD-1.1		
SCALE		QTY.	1,000
UNIT	mm		
Seiko Instruments Inc.			





No. MP005-A-P-SD-1.2

TITLE	SOT235-A-PKG Dimensions
No.	MP005-A-P-SD-1.2
SCALE	
UNIT	mm
Seiko Instruments Inc.	



No. MP005-A-C-SD-2.1

TITLE	SOT235-A-Carrier Tape
No.	MP005-A-C-SD-2.1
SCALE	
UNIT	mm
Seiko Instruments Inc.	



Enlarged drawing in the central part



No. MP005-A-R-SD-1.1

TITLE	SOT235-A-Reel		
No.	MP005-A-R-SD-1.1		
SCALE		QTY.	3,000
UNIT	mm		
Seiko Instruments Inc.			



※ The heatsink of back side has different electric potential depending on the product. Confirm specifications of each product. Do not use it as the function of electrode.

No. PJ006-A-P-SD-2.0

TITLE	HSNT-6A-A-PKG Dimensions
No.	PJ006-A-P-SD-2.0
SCALE	
UNIT	mm
Seiko Instruments Inc.	

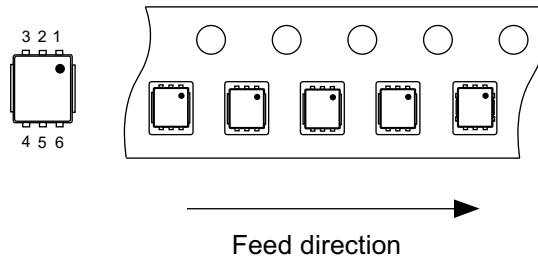

No. PJ006-A-C-SD-1.0

TITLE	HSNT-6A-A-Carrier Tape
No.	PJ006-A-C-SD-1.0
SCALE	
UNIT	mm
Seiko Instruments Inc.	



Enlarged drawing in the central part



No. PJ006-A-R-SD-1.0

TITLE	HSNT-6A-A-Reel		
No.	PJ006-A-R-SD-1.0		
SCALE		QTY.	5,000
UNIT	mm		
Seiko Instruments Inc.			

## Land Recommendation

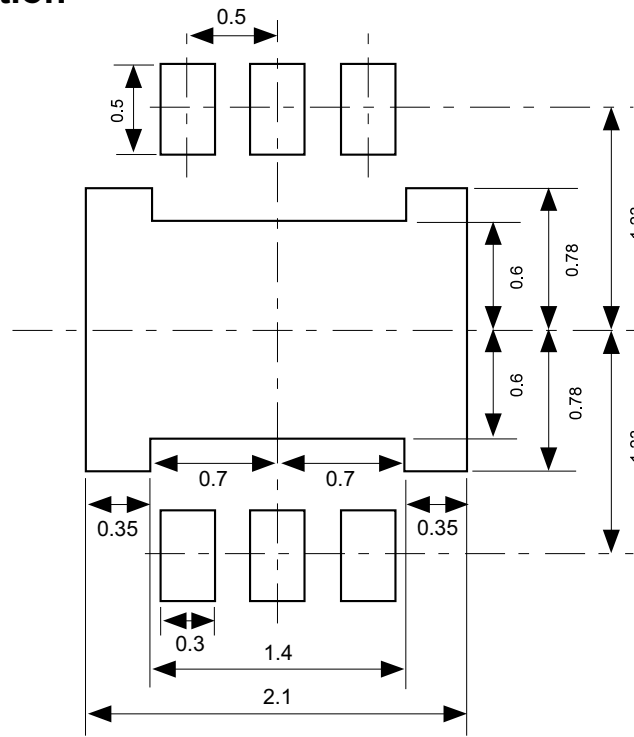

## Stencil Opening

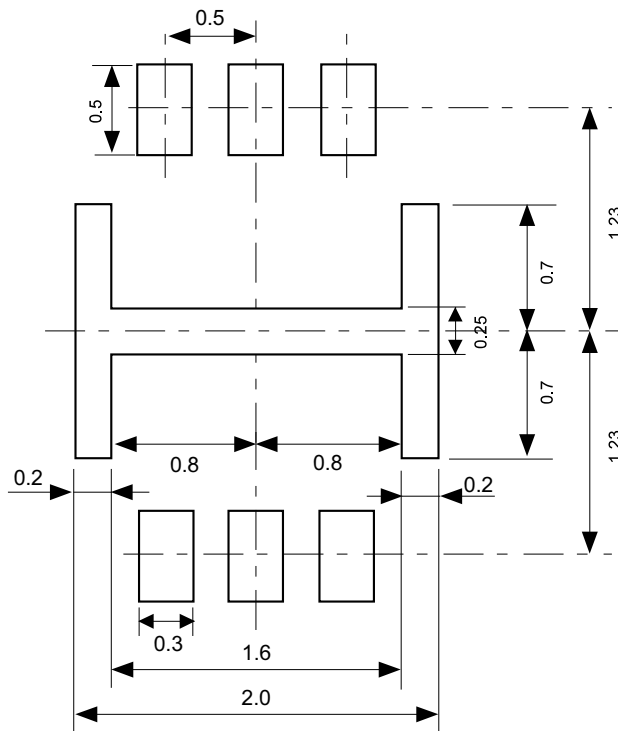

No. PJ006-A-LM-SD-1.0

TITLE	HSNT-6A-A-Land & Stencil Opening
No.	PJ006-A-LM-SD-1.0
SCALE	
UNIT	mm
Seiko Instruments Inc.	



Seiko Instruments Inc.  
[www.sii-ic.com](http://www.sii-ic.com)

- The information described herein is subject to change without notice.
- Seiko Instruments Inc. is not responsible for any problems caused by circuits or diagrams described herein whose related industrial properties, patents, or other rights belong to third parties. The application circuit examples explain typical applications of the products, and do not guarantee the success of any specific mass-production design.
- When the products described herein are regulated products subject to the Wassenaar Arrangement or other agreements, they may not be exported without authorization from the appropriate governmental authority.
- Use of the information described herein for other purposes and/or reproduction or copying without the express permission of Seiko Instruments Inc. is strictly prohibited.
- The products described herein cannot be used as part of any device or equipment affecting the human body, such as exercise equipment, medical equipment, security systems, gas equipment, or any apparatus installed in airplanes and other vehicles, without prior written permission of Seiko Instruments Inc.
- The products described herein are not designed to be radiation-proof.
- Although Seiko Instruments Inc. exerts the greatest possible effort to ensure high quality and reliability, the failure or malfunction of semiconductor products may occur. The user of these products should therefore give thorough consideration to safety design, including redundancy, fire-prevention measures, and malfunction prevention, to prevent any accidents, fires, or community damage that may ensue.



# Mouser Electronics

Authorized Distributor

Click to View Pricing, Inventory, Delivery & Lifecycle Information:

## Seiko Instruments:

[S-1135A10-A6T1S](#) [S-1135A10-M5T1S](#) [S-1135A10-U5T1G](#) [S-1135A11-A6T1S](#) [S-1135A11-M5T1S](#) [S-1135A11-U5T1G](#) [S-1135A12-A6T1S](#) [S-1135A12-M5T1S](#) [S-1135A12-U5T1G](#) [S-1135A13-A6T1S](#) [S-1135A13-M5T1S](#) [S-1135A13-U5T1G](#) [S-1135A14-A6T1S](#) [S-1135A14-M5T1S](#) [S-1135A14-U5T1G](#) [S-1135A15-A6T1S](#) [S-1135A15-M5T1S](#) [S-1135A15-U5T1G](#) [S-1135A16-A6T1S](#) [S-1135A16-M5T1S](#) [S-1135A16-U5T1G](#) [S-1135A17-A6T1S](#) [S-1135A17-M5T1S](#) [S-1135A17-U5T1G](#) [S-1135A18-A6T1S](#) [S-1135A18-M5T1S](#) [S-1135A18-U5T1G](#) [S-1135A19-A6T1S](#) [S-1135A19-M5T1S](#) [S-1135A19-U5T1G](#) [S-1135A1J-A6T1S](#) [S-1135A1J-M5T1S](#) [S-1135A1J-U5T1G](#) [S-1135A20-A6T1S](#) [S-1135A20-M5T1S](#) [S-1135A20-U5T1G](#) [S-1135A21-A6T1S](#) [S-1135A21-M5T1S](#) [S-1135A21-U5T1G](#) [S-1135A22-A6T1S](#) [S-1135A22-M5T1S](#) [S-1135A22-U5T1G](#) [S-1135A23-A6T1S](#) [S-1135A23-M5T1S](#) [S-1135A23-U5T1G](#) [S-1135A24-A6T1S](#) [S-1135A24-M5T1S](#) [S-1135A24-U5T1G](#) [S-1135A25-A6T1S](#) [S-1135A25-M5T1S](#) [S-1135A25-U5T1G](#) [S-1135A26-A6T1S](#) [S-1135A26-M5T1S](#) [S-1135A26-U5T1G](#) [S-1135A27-A6T1S](#) [S-1135A27-M5T1S](#) [S-1135A27-U5T1G](#) [S-1135A28-A6T1S](#) [S-1135A28-M5T1S](#) [S-1135A28-U5T1G](#) [S-1135A29-A6T1S](#) [S-1135A29-M5T1S](#) [S-1135A29-U5T1G](#) [S-1135A2J-A6T1S](#) [S-1135A2J-M5T1S](#) [S-1135A2J-U5T1G](#) [S-1135A30-A6T1S](#) [S-1135A30-M5T1S](#) [S-1135A30-U5T1G](#) [S-1135A31-A6T1S](#) [S-1135A31-M5T1S](#) [S-1135A31-U5T1G](#) [S-1135A32-A6T1S](#) [S-1135A32-M5T1S](#) [S-1135A32-U5T1G](#) [S-1135A33-A6T1S](#) [S-1135A33-M5T1S](#) [S-1135A33-U5T1G](#) [S-1135A34-A6T1S](#) [S-1135A34-M5T1S](#) [S-1135A34-U5T1G](#) [S-1135A35-A6T1S](#) [S-1135A35-M5T1S](#) [S-1135A35-U5T1G](#) [S-1135B10-A6T1S](#) [S-1135B10-M5T1S](#) [S-1135B10-U5T1G](#) [S-1135B11-A6T1S](#) [S-1135B11-M5T1S](#) [S-1135B11-U5T1G](#) [S-1135B12-A6T1S](#) [S-1135B12-M5T1S](#) [S-1135B12-U5T1G](#) [S-1135B13-A6T1S](#) [S-1135B13-M5T1S](#) [S-1135B13-U5T1G](#) [S-1135B14-A6T1S](#) [S-1135B14-M5T1S](#) [S-1135B14-U5T1G](#) [S-1135B15-A6T1S](#)



Компания «ЭлектроПласт» предлагает заключение долгосрочных отношений при поставках импортных электронных компонентов на взаимовыгодных условиях!

Наши преимущества:

- Оперативные поставки широкого спектра электронных компонентов отечественного и импортного производства напрямую от производителей и с крупнейших мировых складов;
- Поставка более 17-ти миллионов наименований электронных компонентов;
- Поставка сложных, дефицитных, либо снятых с производства позиций;
- Оперативные сроки поставки под заказ (от 5 рабочих дней);
- Экспресс доставка в любую точку России;
- Техническая поддержка проекта, помощь в подборе аналогов, поставка прототипов;
- Система менеджмента качества сертифицирована по Международному стандарту ISO 9001;
- Лицензия ФСБ на осуществление работ с использованием сведений, составляющих государственную тайну;
- Поставка специализированных компонентов (Xilinx, Altera, Analog Devices, Intersil, Interpoint, Microsemi, Aeroflex, Peregrine, Syfer, Eurofarad, Texas Instrument, Miteq, Cobham, E2V, MA-COM, Hittite, Mini-Circuits, General Dynamics и др.);

Помимо этого, одним из направлений компании «ЭлектроПласт» является направление «Источники питания». Мы предлагаем Вам помощь Конструкторского отдела:

- Подбор оптимального решения, техническое обоснование при выборе компонента;
- Подбор аналогов;
- Консультации по применению компонента;
- Поставка образцов и прототипов;
- Техническая поддержка проекта;
- Защита от снятия компонента с производства.



#### Как с нами связаться

**Телефон:** 8 (812) 309 58 32 (многоканальный)

**Факс:** 8 (812) 320-02-42

**Электронная почта:** [org@eplast1.ru](mailto:org@eplast1.ru)

**Адрес:** 198099, г. Санкт-Петербург, ул. Калинина, дом 2, корпус 4, литера А.