

Description

The AL8807Q is a step-down DC/DC converter designed to drive LEDs with a constant current. The device can drive up to 9 LEDs, depending on the forward voltage of the LEDs, in series from a voltage source of 6V to 30V. Series connection of the LEDs provides identical LED currents resulting in uniform brightness and eliminating the need for ballast resistors. The AL8807Q switches at frequency up to 1MHz with controlled rise and fall times to reduce EMI. This allows the use of small size external components, hence minimizing the PCB area needed.

Maximum output current of AL8807Q is set via an external resistor connected between the V_{IN} and SET input pins. Dimming is achieved by applying either a DC voltage or a PWM signal at the CTRL input pin. An input voltage of 0.4V or lower at CTRL switches off the output MOSFET simplifying PWM dimming.

The AL8807Q has been qualified to AEC-Q100 Grade 1 and is Automotive Grade supporting PPAPs

Features

- LED driving current up to 1.3A
- Better than 5% accuracy
- High efficiency up to 96%
- Optimally controlled switching speeds
- Operating input voltage from 6V to 30V
- PWM/DC input for dimming control
- Built-in output open-circuit protection
- Automotive Grade with AEC-Q100 Qualification
- MSOP-8EP: Available in "Green" Molding Compound (No Br, Sb)
 - **Totally Lead-Free & Fully RoHS Compliant (Notes 1 & 2)**
 - **Halogen and Antimony Free. "Green" Device (Note 3)**
- Automotive Grade
 - **Qualified to AEC-Q100 Standards for High Reliability**
 - **PPAP Capable (Note 4)**

- Notes:
1. No purposely added lead. Fully EU Directive 2002/95/EC (RoHS) & 2011/65/EU (RoHS 2) compliant.
 2. See http://www.diodes.com/quality/lead_free.html for more information about Diodes Incorporated's definitions of Halogen- and Antimony-free, "Green" and Lead-free.
 3. Halogen- and Antimony-free "Green" products are defined as those which contain <900ppm bromine, <900ppm chlorine (<1500ppm total Br + Cl) and <1000ppm antimony compounds.
 4. Automotive products are AEC-Q100 qualified and are PPAP capable. Automotive, AEC-Q100 and standard products are electrically and thermally the same, except where specified. For more information, please refer to http://www.diodes.com/quality/product_compliance_definitions/.

Pin Assignments

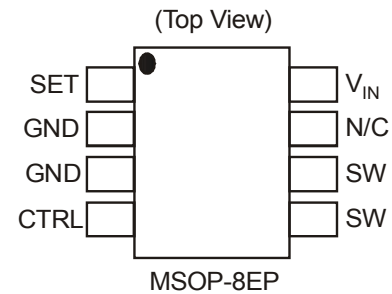

Applications

- Automotive Interior LED Lamps
- Automotive Exterior LED Lamps

Typical Applications Circuit

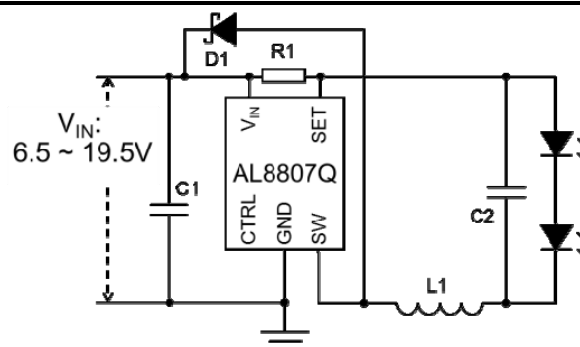

Pin Descriptions

Pin Name	Pin Number	Functions
SET	1	Set Nominal Output Current Pin. Configure the output current of the device.
GND	2, 3	GND Pin
CTRL	4	Dimming and On/Off Control Input. <ul style="list-style-type: none"> Leave floating for normal operation. ($V_{CTRL} = V_{REF} = 2.5V$ giving nominal average output current $I_{OUTnom} = 0.1/R_S$) Drive to voltage below 0.4V to turn off output current Drive with DC voltage ($0.5V < V_{CTRL} < 2.5V$) to adjust output current from 20% to 100% of I_{OUTnom} A PWM signal (low level $\leq 0.4V$ and high level > 2.6; transition times less than 1us) allows the output current to be adjusted below the level set by the resistor connected to SET input pin.
SW	5, 6	Switch Pin. Connect inductor/freewheeling diode here, minimizing track length at this pin to reduce EMI.
N/C	7	no connection
V_{IN}	8	Input Supply Pin. Must be locally decoupled to GND with $\geq 2.2\mu F$ X7R ceramic capacitor – see applications section for more information.
EP	EP	Exposed pad/TAB connect to GND and thermal mass for enhanced thermal impedance. Should not be used as electrical ground conduction path.

Functional Block Diagram

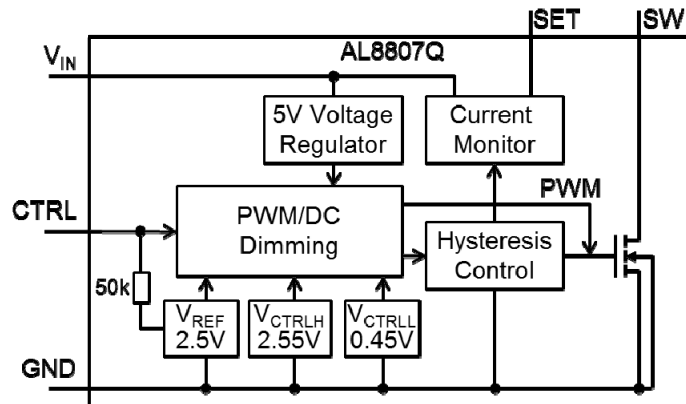

Absolute Maximum Ratings (@ $T_A = +25^\circ C$, unless otherwise specified.)

Symbol	Parameter	Ratings	Unit
ESD HBM	Human Body Model ESD Protection	4000	V
ESD MM	Machine Model ESD Protection	300	V
ESD CDM	Charged Device Model ESD Protection	1000	V
V_{IN}	Continuous V_{IN} pin voltage relative to GND	-0.3 to +40	V
V_{SW}	SW voltage relative to GND	-0.3 to +40	V
V_{CTRL}	CTRL pin input voltage	-0.3 to +6	V
I_{SW-RMS}	DC or RMS Switch current	1.6	A
I_{SW-PK}	Peak Switch current (<10%)	2.5	A
T_J	Junction Temperature	+150	$^\circ C$
T_{LEAD}	Lead Temperature Soldering	+300	$^\circ C$
T_{ST}	Storage Temperature Range	-65 to +150	$^\circ C$

Caution: Stresses greater than the 'Absolute Maximum Ratings' specified above, may cause permanent damage to the device. These are stress ratings only; functional operation of the device at these or any other conditions exceeding those indicated in this specification is not implied. Device reliability may be affected by exposure to absolute maximum rating conditions for extended periods of time. Semiconductor devices are ESD sensitive and may be damaged by exposure to ESD events. Suitable ESD precautions should be taken when handling and transporting these devices.

Recommended Operating Conditions (@ $T_A = +25^\circ\text{C}$, unless otherwise specified.)

Symbol	Parameter	Min	Max	Unit
V_{IN}	Operating Input Voltage relative to GND	6.0	30	V
V_{CTRLH}	Voltage High for PWM dimming relative to GND	2.6	5.5	V
V_{CTRLDC}	Voltage range for 20% to 100% DC dimming relative to GND	0.5	2.5	V
V_{CTRLLL}	Voltage Low for PWM dimming relative to GND	0	0.4	V
f_{SW}	Maximum switching frequency	—	1	MHz
I_{SW}	Continuous switch current	—	1.3	A
T_J	Junction Temperature Range	-40	125	$^\circ\text{C}$

Electrical Characteristics (@ $V_{IN} = 12\text{V}$, $T_A = +25^\circ\text{C}$, unless otherwise specified.)

Symbol	Parameter	Conditions	Min	Typ	Max	Unit
V_{INSU}	Internal regulator start up threshold	V_{IN} rising	—	—	5.9	V
V_{INSH}	Internal regulator hysteresis threshold	V_{IN} falling	100	—	300	mV
I_Q	Quiescent current	Output not switching (Note 5)	—	—	350	μA
I_S	Input supply Current	CTRL pin floating $f = 250\text{kHz}$	—	1.8	5	mA
V_{TH}	Set current Threshold Voltage	—	95	100	105	mV
V_{TH-H}	Set threshold hysteresis	—	—	± 20	—	mV
I_{SET}	SET pin input current	$V_{SET} = V_{IN} - 0.1$	—	16	22	μA
R_{CTRL}	CTRL pin input resistance	Referred to internal reference	—	50	—	k Ω
V_{REF}	Internal Reference Voltage	—	—	2.5	—	V
$R_{DS(on)}$	On Resistance of SW MOSFET	$I_{SW} = 1\text{A}$	—	0.25	0.4	Ω
t_R	SW rise time	$V_{SENSE} = 100 \pm 20\text{mV}$, $f_{SW} = 250\text{kHz}$	—	12	—	ns
t_F	SW fall time	$V_{SW} = 0.1\text{V} \sim 12\text{V} \sim 0.1\text{V}$ $C_L = 15\text{pF}$	—	20	—	ns
$I_{SW_Leakage}$	Switch leakage current	$V_{IN} = 30\text{V}$	—	—	0.5	μA
θ_{JA}	Thermal Resistance Junction-to-Ambient (Note 6)	(Note 7)	—	69	—	$^\circ\text{C/W}$
θ_{JC}	Thermal Resistance Junction-to-case (Note 8)	(Note 7)	—	4.3	—	—

- Notes:
- AL8807Q does not have a low power standby mode but current consumption is reduced when output switch is inhibited: $V_{SENSE} = 0\text{V}$. Parameter is tested with $V_{CTRL} \leq 2.5\text{V}$
 - Refer to figure 35 for the device derating curve.
 - Test condition for MSOP-8EP: Device mounted on FR-4 PCB (51mm x 51mm 2oz copper, minimum recommended pad layout on top layer and thermal vias to bottom layer with maximum area ground plane. For better thermal performance, larger copper pad for heat-sink is needed
 - Dominant conduction path via exposed pad.

Typical Performance Characteristics (@ $T_A = +25^\circ\text{C}$, unless otherwise specified.)

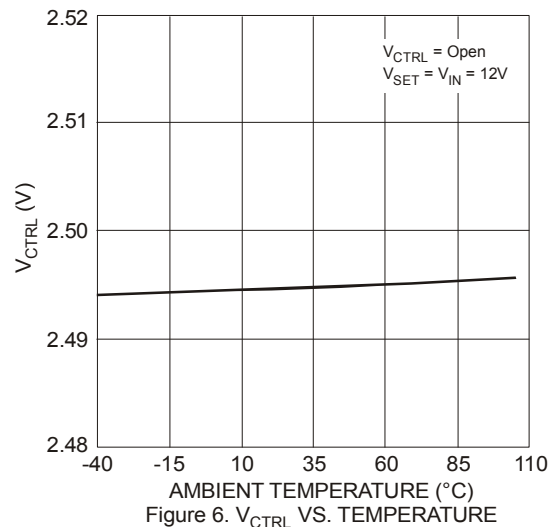
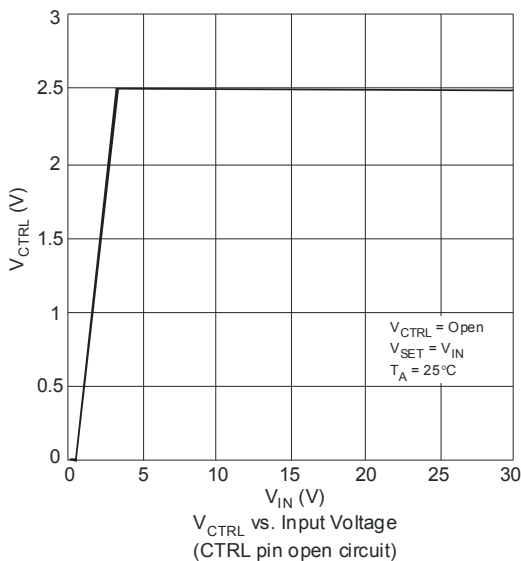
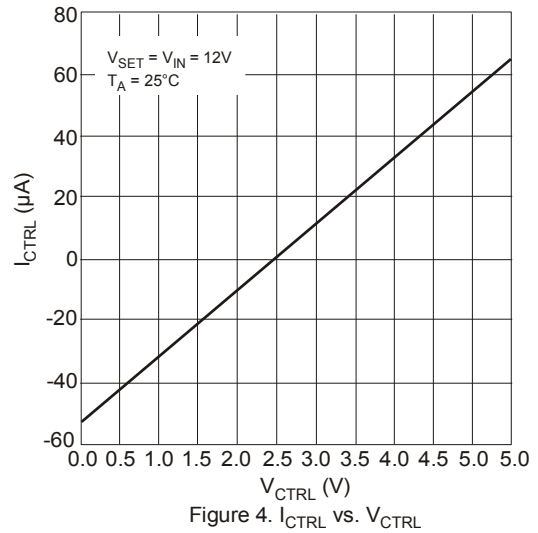
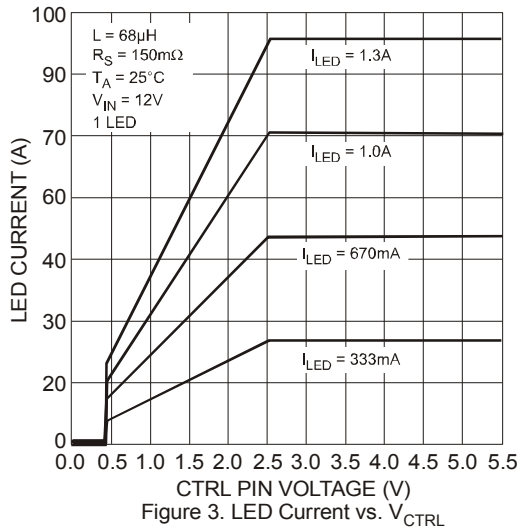
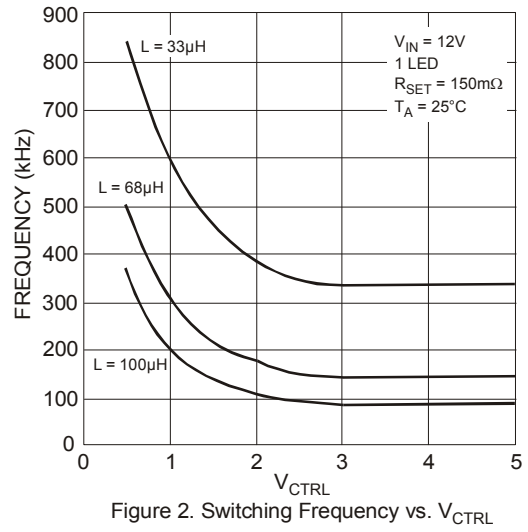
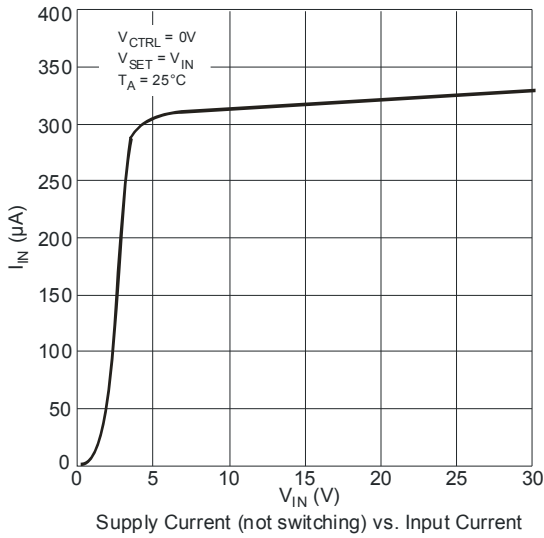

Typical Performance Characteristics (cont.) (@ $T_A = +25^\circ\text{C}$, unless otherwise specified.)

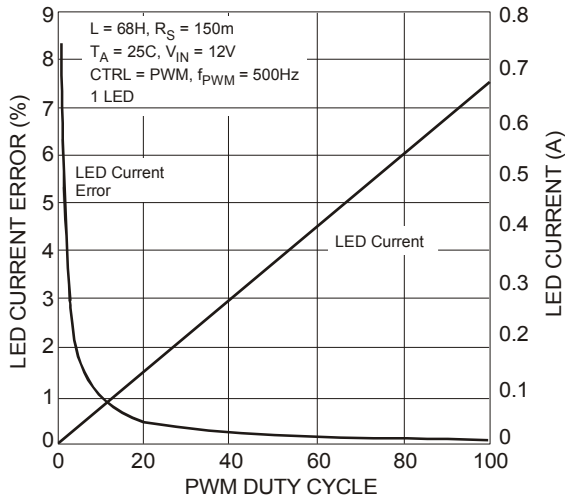
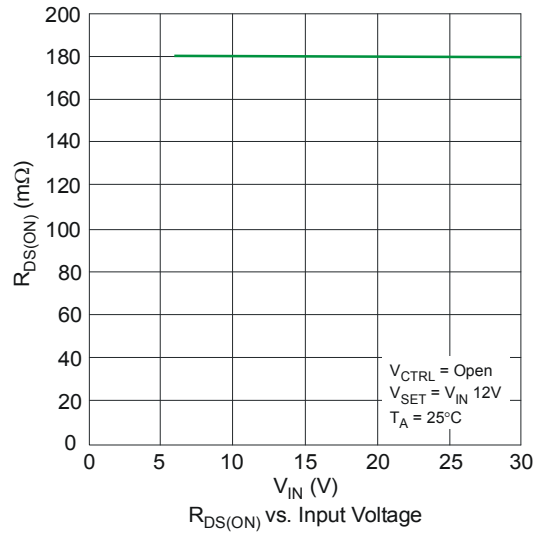

Figure 7. I_{LED} vs. PWM Duty Cycle



$R_{\text{DS(ON)}}$ vs. Input Voltage

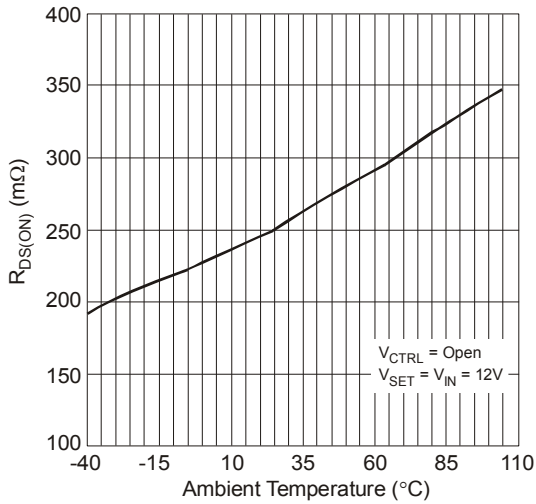

Figure 9. SW $R_{\text{DS(ON)}}$ vs. Temperature

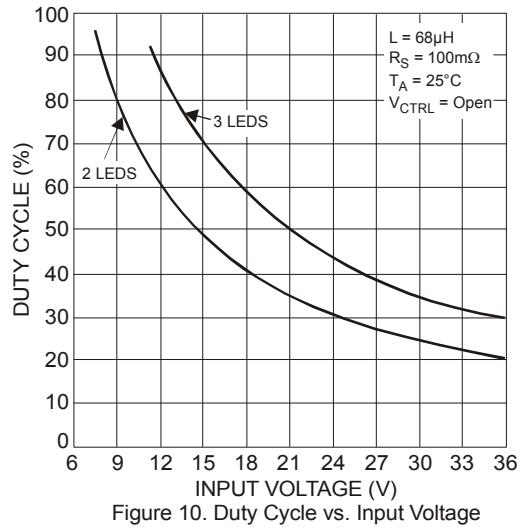

Figure 10. Duty Cycle vs. Input Voltage

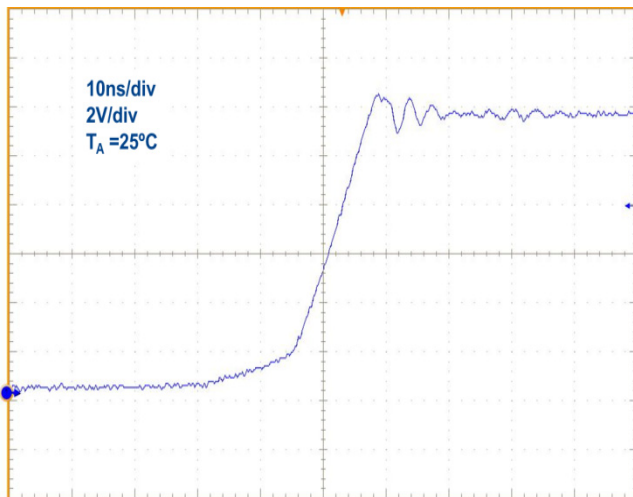

Figure 11 SW Output Rise Time

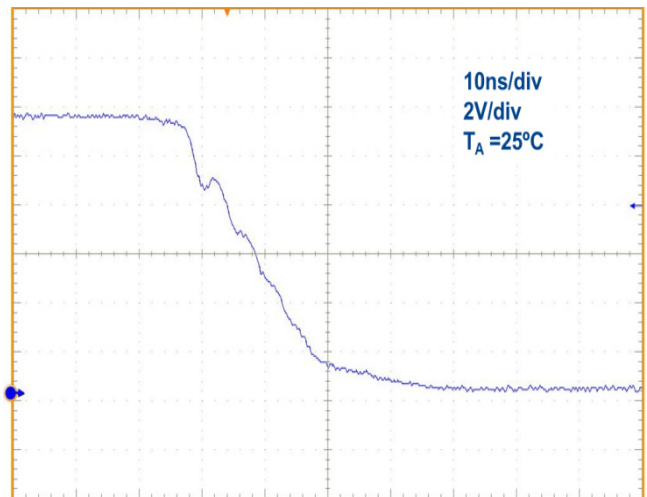

Figure 12 SW Output Fall Time

Typical Performance Characteristics 670mA LED Current (cont.) (@ $T_A = +25^\circ\text{C}$, unless otherwise specified.)

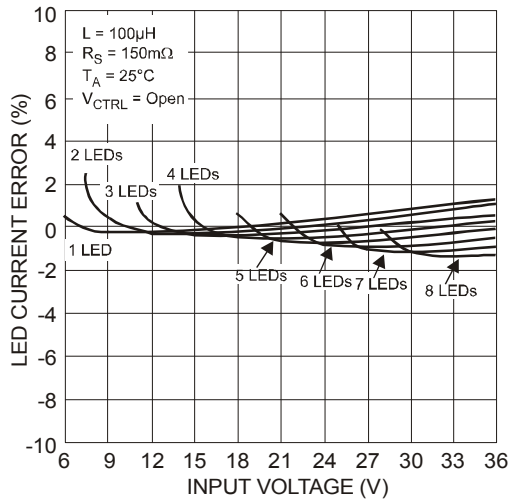

Figure 13. LED Current Deviation vs. Input Voltage

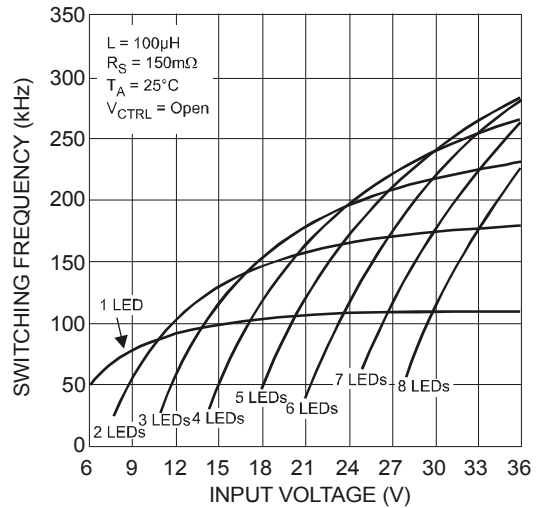

Figure 14. Switching Frequency vs. Input Voltage

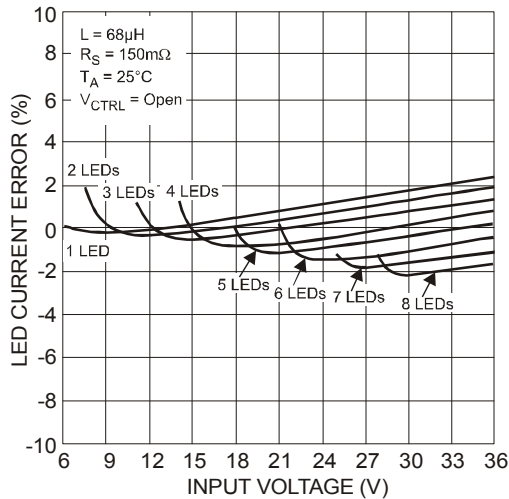

Figure 15. LED Current Deviation vs. Input Voltage

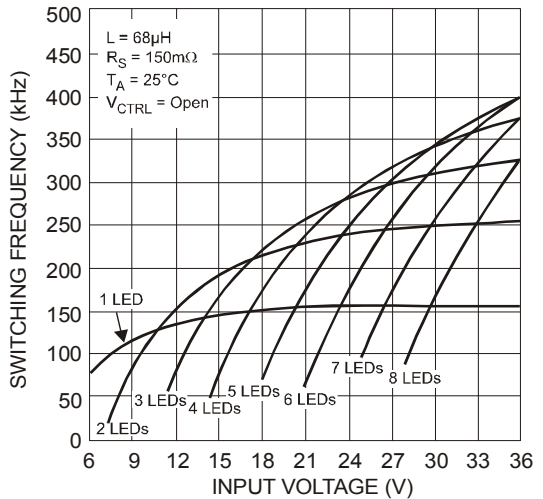

Figure 16. Switching Frequency vs. Input Voltage

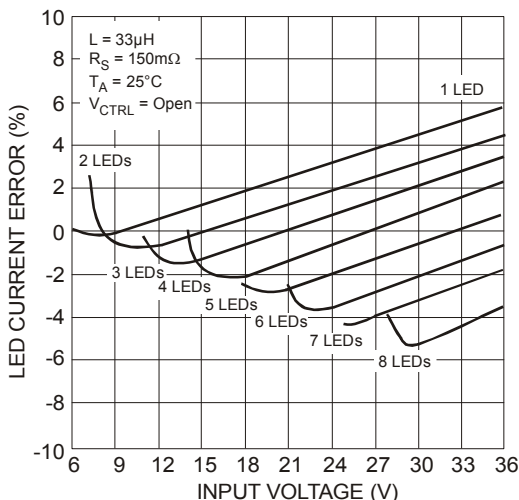

Figure 17. LED Current Deviation vs. Input Voltage

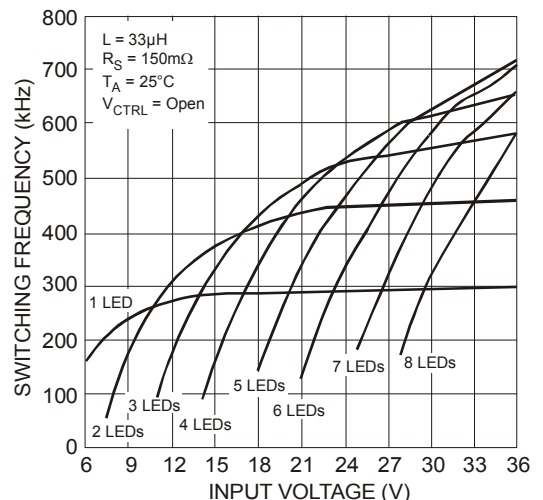

Figure 18. Switching Frequency vs. Input Voltage

Typical Performance Characteristics 1A LED Current (cont.) (@ $T_A = +25^\circ\text{C}$, unless otherwise specified.)

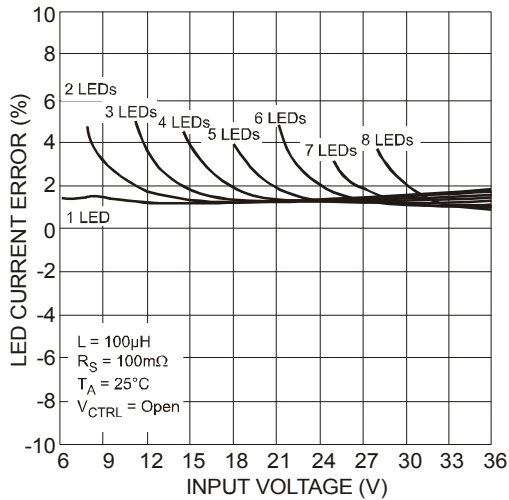

Figure 19. LED Current Deviation vs. Input Voltage

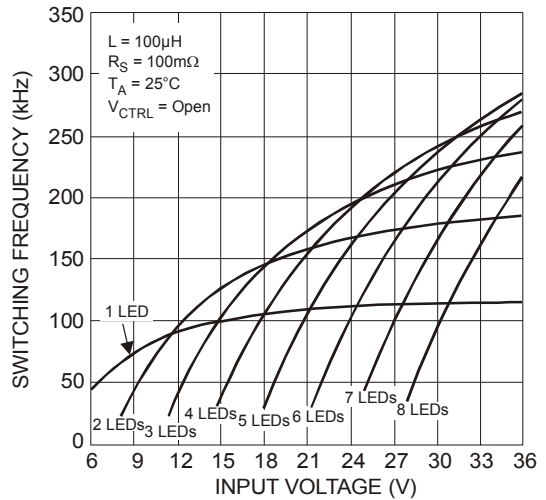

Figure 20. Switching Frequency vs. Input Voltage

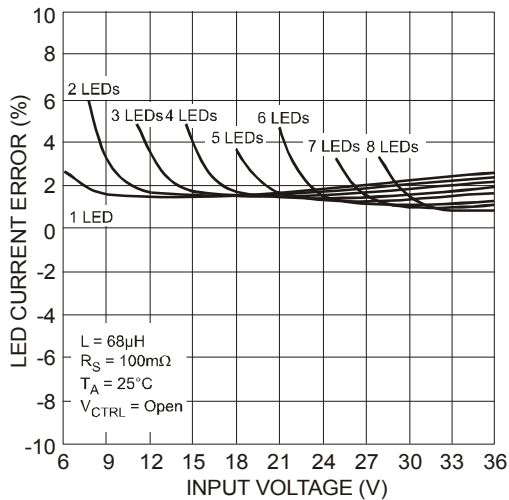

Figure 21. LED Current Deviation vs. Input Voltage

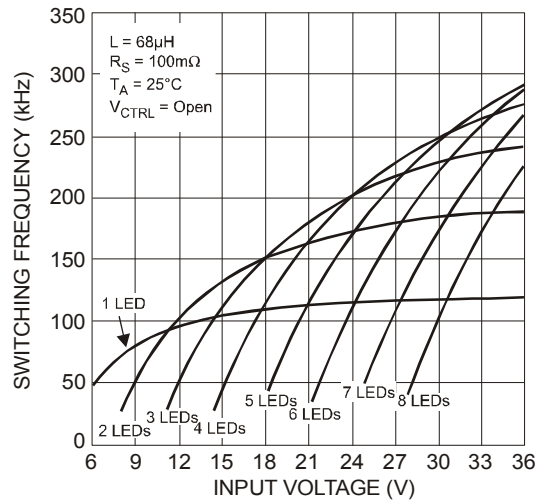

Figure 22. Switching Frequency vs. Input Voltage

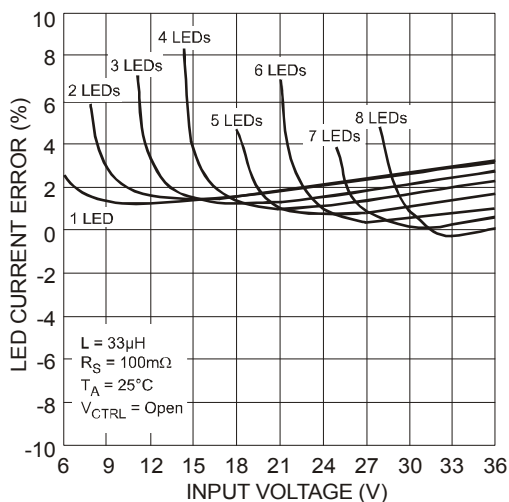

Figure 23. LED Current Deviation vs. Input Voltage

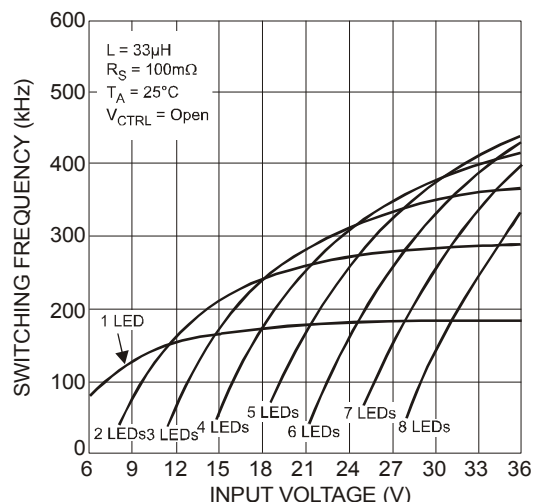

Figure 24. Switching Frequency vs. Input Voltage

Typical Performance Characteristics 1.3A LED Current (cont.) (@ $T_A = +25^\circ\text{C}$, unless otherwise specified.)

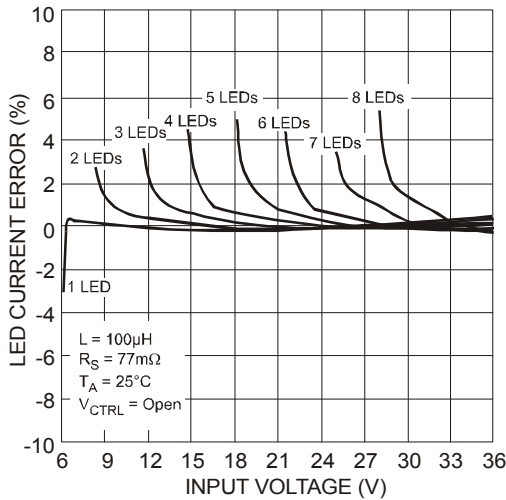

Figure 25. LED Current Deviation vs. Input Voltage

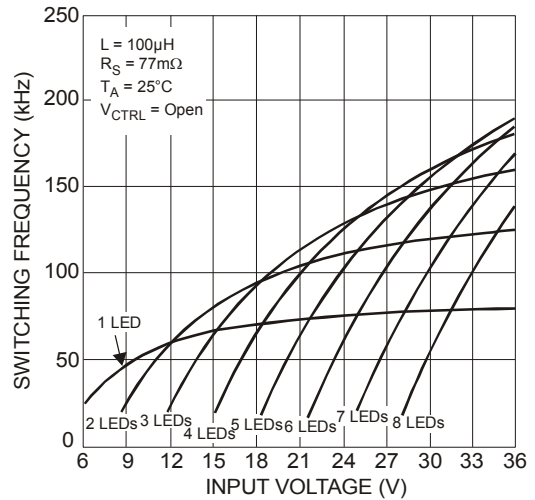

Figure 26. Switching Frequency vs. Input Voltage

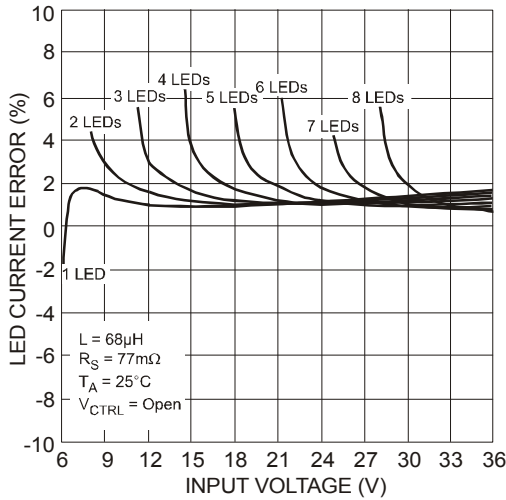

Figure 27. LED Current Deviation vs. Input Voltage

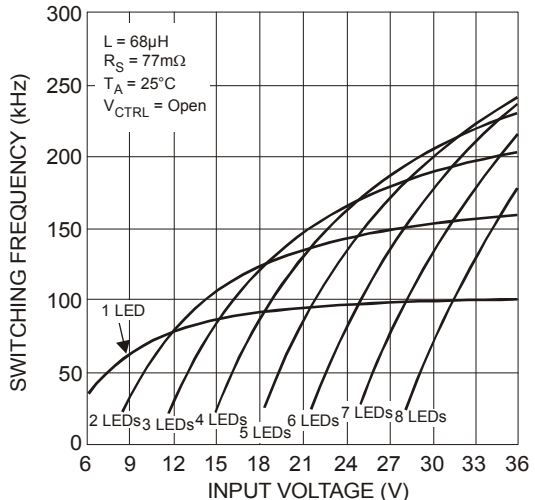

Figure 28. Switching Frequency vs. Input Voltage

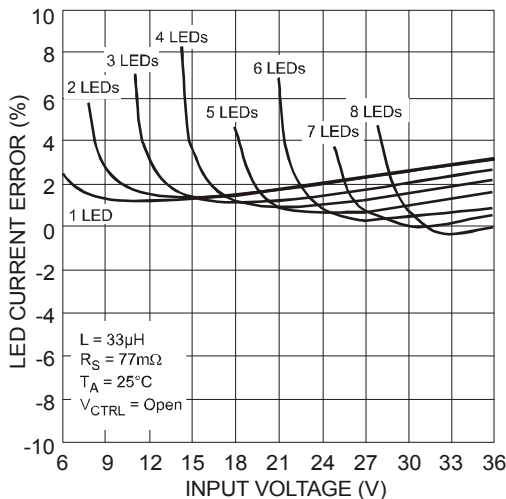

Figure 29. LED Current Deviation vs. Input Voltage

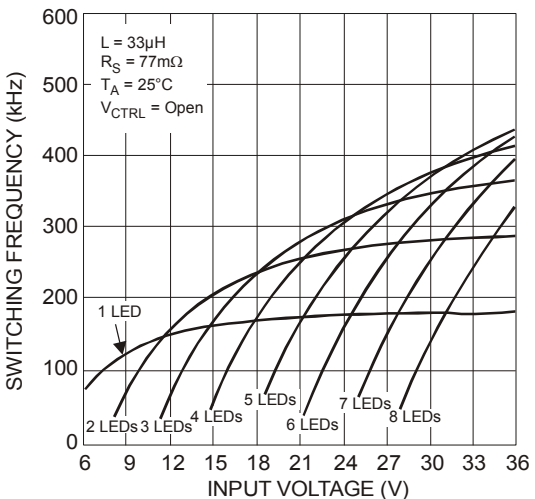

Figure 30. Switching Frequency vs. Input Voltage

Application Information

The AL8807Q is a hysteretic (also known as equal ripple) LED driver with integrated power switch. It is available in two packages that provide a PCB area-power dissipation capability compromise. It is recommended that at higher LED currents/smaller PCBs that the MSOP-8EP version is used to maximize the allowable LED current over a wider ambient temperature range.

AL8807Q Operation

In normal operation, when voltage is applied at +V_{IN}, the AL8807Q internal switch is turned on. Current starts to flow through sense resistor R₁, inductor L₁, and the LEDs. The current ramps up linearly, and the ramp rate is determined by the input voltage +V_{in} and the inductor L₁.

This rising current produces a voltage ramp across R₁. The internal circuit of the AL8807Q senses the voltage across R₁ and applies a proportional voltage to the input of the internal comparator.

When this voltage reaches an internally set upper threshold, the internal switch is turned off. The inductor current continues to flow through R₁, L₁, the LEDs and the schottky diode D₁, and back to the supply rail, but it decays, with the rate of decay determined by the forward voltage drop of the LEDs and the schottky diode.

This decaying current produces a falling voltage at R₁, which is sensed by the AL8807Q. A voltage proportional to the sense voltage across R₁ is applied at the input of the internal comparator. When this voltage falls to the internally set lower threshold, the internal switch is turned on again. This switch-on-and-off cycle continues to provide the average LED current set by the sense resistor R₁.

LED Current Control

The LED current is controlled by the resistor R₁ in Figure 30.

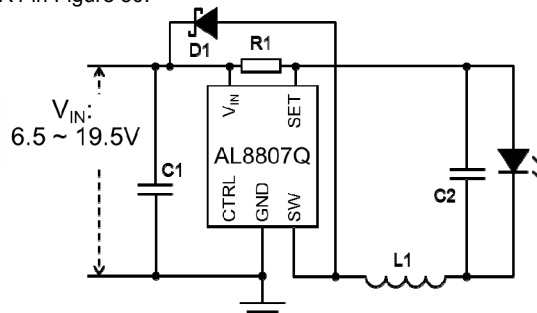

Figure 30 Typical Application Circuit

Connected between V_{IN} and SET the nominal average output current in the LED(s) is defined as:

$$I_{LED} = \frac{V_{THD}}{R1}$$

For example for a desired LED current of 660mA and a default voltage V_{CTRL}=2.5V the resulting resistor is:

$$R1 = \frac{V_{THD}}{I_{LED}} = \frac{0.1}{0.66} \approx 150m\Omega$$

Analog Dimming

Further control of the LED current can be achieved by driving the CTRL pin with an external voltage (between 0.4V and 2.5V); the average LED current becomes:

$$I_{LED} = \frac{V_{CTRL}}{V_{REF}} \frac{V_{THD}}{R_{SET}}$$

With $0.5V \leq V_{CTRL} \leq 2.5V$ the LED current varies linearly with V_{CTRL}, as in figure 2. If the CTRL pin is brought higher than 2.5V, the LED current will be clamped to approximately 100% and follows $I_{LED} = \frac{V_{THD}}{R_{SET}}$.

When the CTRL voltage falls below the threshold, 0.4V, the output switch is turned off which allows PWM dimming.

Application Information (cont.)

PWM Dimming

LED current can be adjusted digitally, by applying a low frequency Pulse Width Modulated (PWM) logic signal to the CTRL pin to turn the device on and off. This will produce an average output current proportional to the duty cycle of the control signal. In particular, a PWM signal with a max resolution of 10bit can be applied to the CTRL pin to change the output current to a value below the nominal average value set by resistor R_{SET} . To achieve this resolution the PWM frequency has to be lower than 500Hz, however higher dimming frequencies can be used, at the expense of dimming dynamic range and accuracy.

Typically, for a PWM frequency of 500Hz the accuracy is better than 1% for PWM ranging from 1% to 100%.

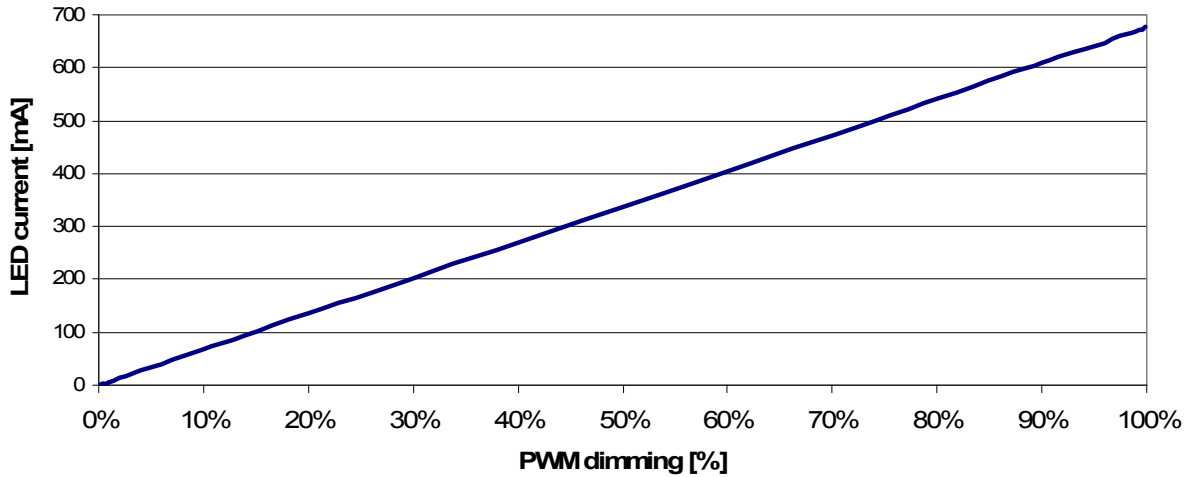

Figure 31 PWM Dimming at 500Hz

Zooming in at duty cycles below 10% shows:

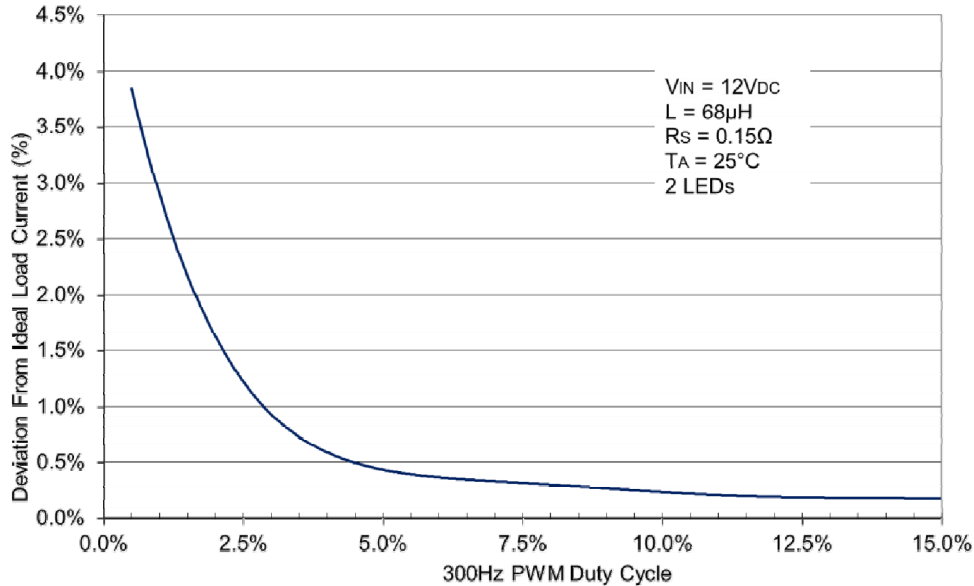

Figure 32 Low Duty Cycle PWM Dimming at 300Hz

The accuracy of the low duty cycle dimming is affected by both the PWM frequency and also the switching frequency of the AL8807Q. For best accuracy/resolution the switching frequency should be increased while the PWM frequency should be reduced.

The CTRL pin is designed to be driven by both 3.3V and 5V logic levels directly from a logic output with either an open drain output or push pull output stage.

Application Information (cont.)

Soft Start

The AL8807Q does not have in-built soft-start action – this provides very fast turn off of the output the stage improving PWM dimming accuracy; nonetheless, adding an external capacitor from the CTRL pin to ground will provide a soft-start delay. This is achieved by increasing the time taken for the CTRL voltage to rise to the turn-on threshold and by slowing down the rate of rise of the control voltage at the input of the comparator. Adding a capacitor increases the time taken for the output to reach 90% of its final value, this delay is 0.1ms/nF, but will impact on the PWM dimming accuracy depending on the delay introduced.

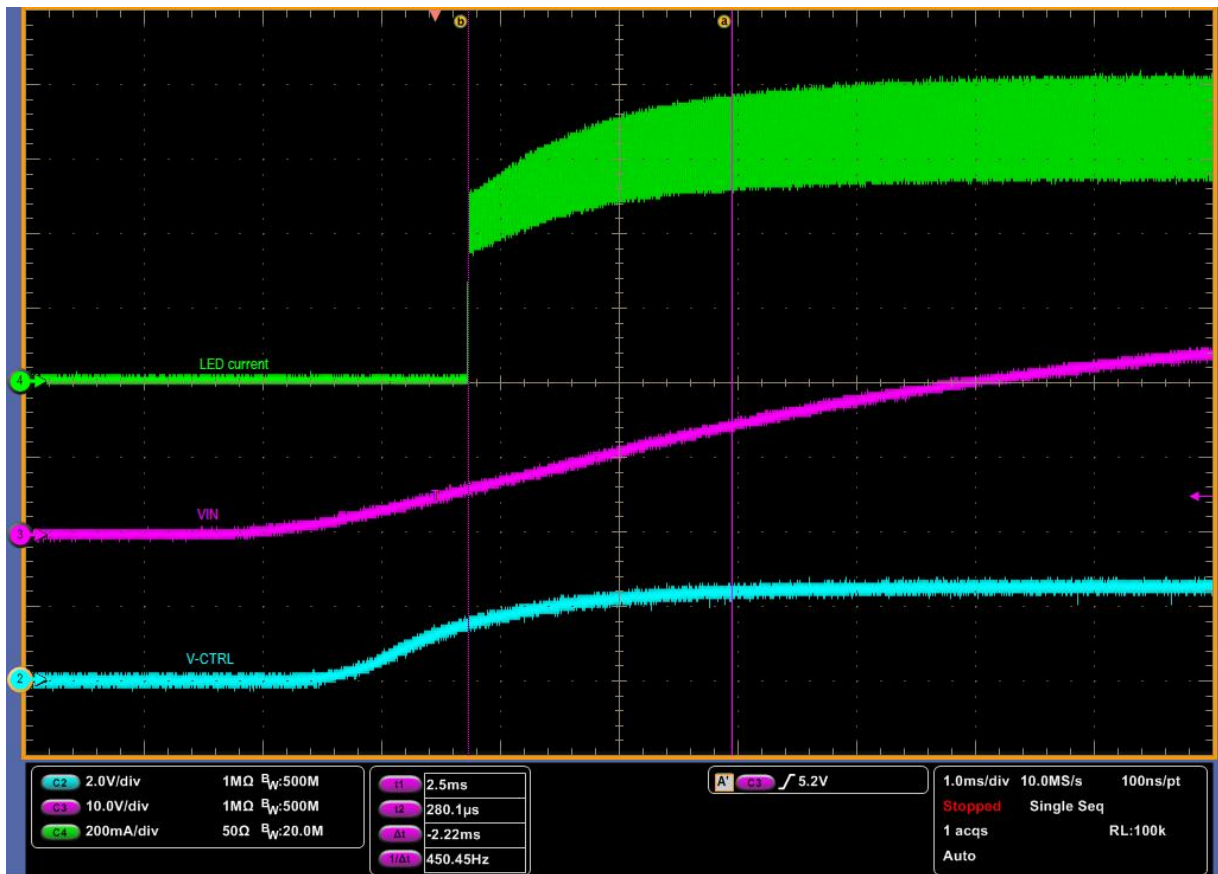

Figure 33 Soft Start with 22nF Capacitor on CTRL Pin ($V_{IN} = 30V$, $I_{LED} = 667mA$, 1 LED)

Reducing Output Ripple

Peak to peak ripple current in the LED(s) can be reduced, if required, by shunting a capacitor C2 across the LED(s) as shown already in the circuit schematic.

A value of 1μF will reduce the supply ripple current by a factor three (approx.). Proportionally lower ripple can be achieved with higher capacitor values. Note that the capacitor will not affect operating frequency or efficiency, but it will increase start-up delay, by reducing the rate of rise of LED voltage. By adding this capacitor the current waveform through the LED(s) changes from a triangular ramp to a more sinusoidal version without altering the mean current value.

Capacitor Selection

The small size of ceramic capacitors makes them ideal for AL8807Q applications. X5R and X7R types are recommended because they retain their capacitance over wider voltage and temperature ranges than other types such as Z5U.

A 2.2μF input capacitor is sufficient for most intended applications of AL8807Q; however a 4.7μF input capacitor is suggested for input voltages approaching 30V.

Application Information (cont.)

Diode Selection

For maximum efficiency and performance, the rectifier (D1) should be a fast low capacitance Schottky diode with low reverse leakage at the maximum operating voltage and temperature. The Schottky diode also provides better efficiency than silicon PN diodes, due to a combination of lower forward voltage and reduced recovery time.

It is important to select parts with a peak current rating above the peak coil current and a continuous current rating higher than the maximum output load current. In particular, it is recommended to have a diode voltage rating at least 15% higher than the operating voltage to ensure safe operation during the switching and a current rating at least 10% higher than the average diode current. The power rating is verified by calculating the power loss through the diode.

Schottky diodes, e.g. B240 or B140, with their low forward voltage drop and fast reverse recovery, are the ideal choice for AL8807Q applications.

Inductor Selection

Recommended inductor values for the AL8807Q are in the range 33µH to 100µH.

Higher values of inductance are recommended at higher supply voltages in order to minimize errors due to switching delays, which result in increased ripple and lower efficiency. Higher values of inductance also result in a smaller change in output current over the supply voltage range. (See graphs).

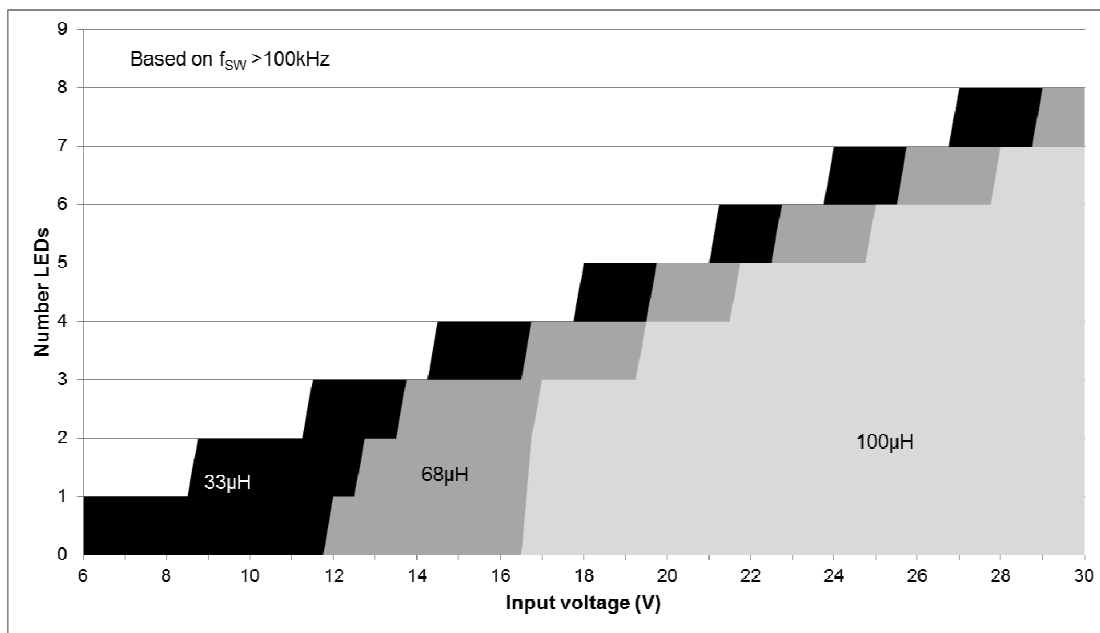

Figure 34 Inductor Value with Input Voltage and Number of LEDs

The inductor should be mounted as close to the device as possible with low resistance/stray inductance connections to the SW pin.

The chosen coil should have a saturation current higher than the peak output current and a continuous current rating above the required mean output current.

Suitable coils for use with the AL8807Q are listed in the table below:

Part No.	L (µH)	DCR (V)	ISAT (A)	Manufacturer
MSS1038-333	33	0.093	2.3	CoilCraft www.coilcraft.com
MSS1038-683	68	0.213	1.5	
NPIS64D330MTRF	33	0.124	1.1	NIC www.niccomp.com

The inductor value should be chosen to maintain operating duty cycle and switch 'on'/'off' times over the supply voltage and load current range.

Application Information (cont.)

Inductor Selection (cont.)

The following equations can be used as a guide, with reference to Figure 1 - Operating waveforms.

$$t_{ON} = \frac{\text{Switch 'On' time } L\Delta I}{V_{IN} - V_{LED} - I_{AVG} \times (R_S + r_L + R_{SW})}$$

$$t_{OFF} = \frac{\text{Switch 'Off' time } L\Delta I}{V_{LED} + V_D + I_{AVG} \times (R_S + r_L)}$$

Where:

- L is the coil inductance (H)
- r_L is the coil resistance (Ω) R_S is the current sense resistance (Ω)
- I_{avg} is the required LED current (A)
- ΔI is the coil peak-peak ripple current (A) {Internally set to 0.3 x I_{avg}}
- V_{IN} is the supply voltage (V)
- V_{LED} is the total LED forward voltage (V)
- R_{SW} is the switch resistance (Ω) {=0.5Ω nominal}
- V_D is the diode forward voltage at the required load current (V)

Thermal Considerations

For continuous conduction mode of operation, the absolute maximum junction temperature must not be exceeded. The maximum power dissipation depends on several factors: the thermal resistance of the IC package θ_{JA}, PCB layout, airflow surrounding the IC, and difference between junction and ambient temperature.

The maximum power dissipation can be calculated using the following formula:

$$P_{D(MAX)} = (T_{J(MAX)} - T_A) / \theta_{JA}$$

T_{J(MAX)} is the maximum operating junction temperature,
T_A is the ambient temperature, and
θ_{JA} is the junction to ambient thermal resistance.

The recommended maximum operating junction temperature, T_J, is 125°C and so maximum ambient temperature is determined by the AL8807Q's junction to ambient thermal resistance, θ_{JA} and device power dissipation. To support high LED drive at higher ambient temperatures the AL8807Q has been packaged in thermally enhanced MSOP-8EP package.

θ_{JA}, is layout dependent and the AL8806Q's θ_{JA} in MSOP-8EP on a 51 x 51mm double layer PCB with 2oz copper standing in still air is approximately 69°C/W.

Therefore the maximum power dissipation at T_A = 25°C is:

$$P_{D(MAX)} = \frac{(125^\circ\text{C} - 25^\circ\text{C})}{69^\circ\text{C/W}} = 1.45\text{W}$$

Figure 35, shows the power derating of the AL8807QMP on an FR4 51x51mm PCB with 2oz copper standing in still air.

As the ambient temperature increases and/or the PCB area reduces the maximum allowable power dissipated by the AL8807Q will decrease.

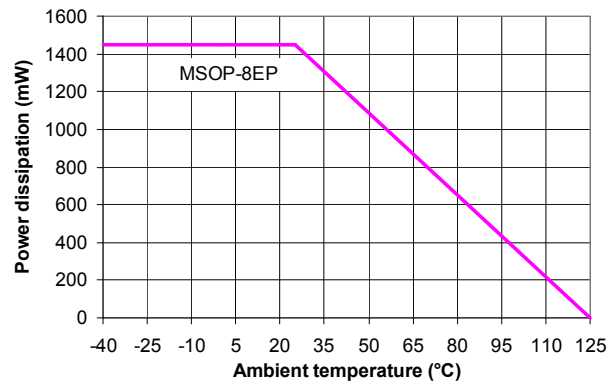

Figure 35 Derating Curve for Different PCB

Application Information (cont.)

EMI and Layout Considerations

The AL8807Q is a switching regulator with fast edges and measures small differential voltages; as a result of this care has to be taken with decoupling and layout of the PCB. To help with these effects the AL8807Q has been developed to minimise radiated emissions by controlling the switching speeds of the internal power MOSFET. The rise and fall times are controlled to get the right compromise between power dissipation due to switching losses and radiated EMI. The turn-on edge (falling edge) dominates the radiated EMI which is due to an interaction between the Schottky diode (D1), Switching MOSFET and PCB tracks. After the Schottky diode reverse recovery time of around 5ns has occurred; the falling edge of the SW pin sees a resonant loop between the Schottky diode capacitance and the track inductance, L_{TRACK} , See figure 36.

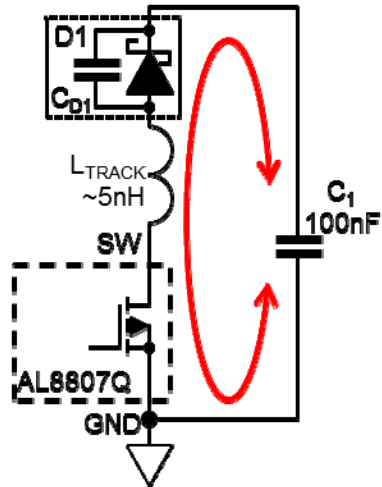

Figure 36 PCB Loop Resonance

The tracks from the SW pin to the Anode of the Schottky diode, D1, and then from D1's cathode to the decoupling capacitors C1 should be as short as possible. There is an inductance internally in the AL8807Q this can be assumed to be around 1nH. For PCB tracks a figure of 0.5nH per mm can be used to estimate the primary resonant frequency. If the track is capable of handling 1A increasing the thickness will have a minor effect on the inductance and length will dominate the size of the inductance. The resonant frequency of any oscillation is determined by the combined inductance in the track and the effective capacitance of the Schottky diode.

Recommendations for minimising radiated EMI and other transients and thermal considerations are:

1. The decoupling capacitor (C1) has to be placed as close as possible to the V_{IN} pin and D1 Cathode
2. The freewheeling diode's (D1) anode, the SW pin and the inductor have to be placed as close as possible to each other to avoid ringing.
3. The Ground return path from C1 must be a low impedance path with the ground plane as large as possible
4. The LED current sense resistor (R1) has to be placed as close as possible to the V_{IN} and SET pins.
5. The majority of the conducted heat from the AL8807Q is through the GND pin 2. A maximum earth plane with thermal vias into a second earth plane will minimise self-heating
6. To reduce emissions via long leads on the supply input and LEDs low RF impedance capacitors (C2 and C5) should be used at the point the wires are joined to the PCB.

Ordering Information

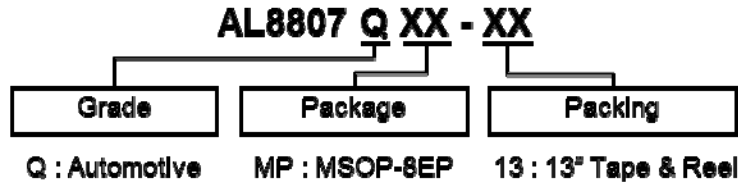

Part Number	Package Code	Packaging (Note 9)	Packing: 13" Tape and Reel			Qualification Grade (Note 10)
			Quantity	Tape Width	Part Number Suffix	
AL8807QMP-13	MP	MSOP-8EP	2500	12mm	-13	Automotive Grade

Note: 9. Pad layout as shown on Diodes Inc. suggested pad layout document AP02001, which can be found on our website at <http://www.diodes.com/datasheets/ap02001.pdf>

10. AL8807Q has been qualified to AEC-Q100 grade 1 and is classified as "Automotive Grade" which supports PPAP documentation. See AL8807 datasheet for commercial qualified versions.

Marking Information

(1) MSOP-8EP

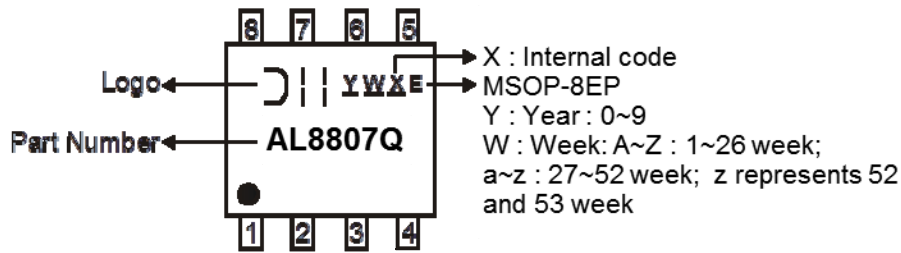

Part Number	Package
AL8807QMP-13	MSOP-8EP

Package Outline Dimensions (All dimensions in mm.)

Please see AP02002 at <http://www.diodes.com/datasheets/ap02002.pdf> for latest version.

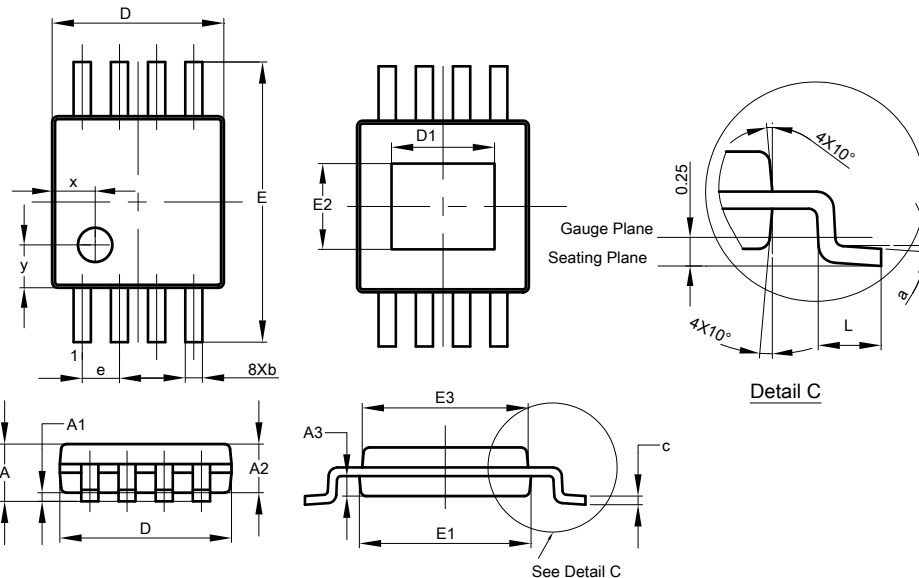

MSOP-8EP			
Dim	Min	Max	Typ
A	-	1.10	-
A1	0.05	0.15	0.10
A2	0.75	0.95	0.86
A3	0.29	0.49	0.39
b	0.22	0.38	0.30
c	0.08	0.23	0.15
D	2.90	3.10	3.00
D1	1.60	2.00	1.80
E	4.70	5.10	4.90
E1	2.90	3.10	3.00
E2	1.30	1.70	1.50
E3	2.85	3.05	2.95
e	-	-	0.65
L	0.40	0.80	0.60
a	0°	8°	4°
x	-	-	0.750
y	-	-	0.750

All Dimensions in mm

Suggested Pad Layout

Please see AP02001 at <http://www.diodes.com/datasheets/ap02001.pdf> for the latest version.

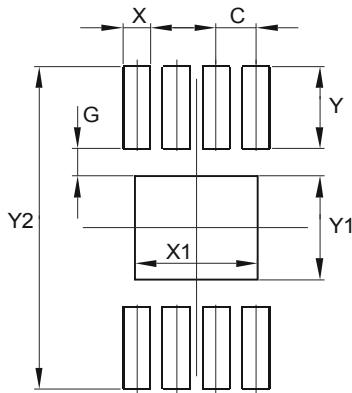

Dimensions	Value (in mm)
C	0.650
G	0.450
X	0.450
X1	2.000
Y	1.350
Y1	1.700
Y2	5.300

IMPORTANT NOTICE

DIODES INCORPORATED MAKES NO WARRANTY OF ANY KIND, EXPRESS OR IMPLIED, WITH REGARDS TO THIS DOCUMENT, INCLUDING, BUT NOT LIMITED TO, THE IMPLIED WARRANTIES OF MERCHANTABILITY AND FITNESS FOR A PARTICULAR PURPOSE (AND THEIR EQUIVALENTS UNDER THE LAWS OF ANY JURISDICTION).

Diodes Incorporated and its subsidiaries reserve the right to make modifications, enhancements, improvements, corrections or other changes without further notice to this document and any product described herein. Diodes Incorporated does not assume any liability arising out of the application or use of this document or any product described herein; neither does Diodes Incorporated convey any license under its patent or trademark rights, nor the rights of others. Any Customer or user of this document or products described herein in such applications shall assume all risks of such use and will agree to hold Diodes Incorporated and all the companies whose products are represented on Diodes Incorporated website, harmless against all damages.

Diodes Incorporated does not warrant or accept any liability whatsoever in respect of any products purchased through unauthorized sales channel. Should Customers purchase or use Diodes Incorporated products for any unintended or unauthorized application, Customers shall indemnify and hold Diodes Incorporated and its representatives harmless against all claims, damages, expenses, and attorney fees arising out of, directly or indirectly, any claim of personal injury or death associated with such unintended or unauthorized application.

Products described herein may be covered by one or more United States, international or foreign patents pending. Product names and markings noted herein may also be covered by one or more United States, international or foreign trademarks.

This document is written in English but may be translated into multiple languages for reference. Only the English version of this document is the final and determinative format released by Diodes Incorporated.

LIFE SUPPORT

Diodes Incorporated products are specifically not authorized for use as critical components in life support devices or systems without the express written approval of the Chief Executive Officer of Diodes Incorporated. As used herein:

- A. Life support devices or systems are devices or systems which:
 - 1. are intended to implant into the body, or
 - 2. support or sustain life and whose failure to perform when properly used in accordance with instructions for use provided in the labeling can be reasonably expected to result in significant injury to the user.
- B. A critical component is any component in a life support device or system whose failure to perform can be reasonably expected to cause the failure of the life support device or to affect its safety or effectiveness.

Customers represent that they have all necessary expertise in the safety and regulatory ramifications of their life support devices or systems, and acknowledge and agree that they are solely responsible for all legal, regulatory and safety-related requirements concerning their products and any use of Diodes Incorporated products in such safety-critical, life support devices or systems, notwithstanding any devices- or systems-related information or support that may be provided by Diodes Incorporated. Further, Customers must fully indemnify Diodes Incorporated and its representatives against any damages arising out of the use of Diodes Incorporated products in such safety-critical, life support devices or systems.

Copyright © 2014, Diodes Incorporated

www.diodes.com



Компания «ЭлектроПласт» предлагает заключение долгосрочных отношений при поставках импортных электронных компонентов на взаимовыгодных условиях!

Наши преимущества:

- Оперативные поставки широкого спектра электронных компонентов отечественного и импортного производства напрямую от производителей и с крупнейших мировых складов;
- Поставка более 17-ти миллионов наименований электронных компонентов;
- Поставка сложных, дефицитных, либо снятых с производства позиций;
- Оперативные сроки поставки под заказ (от 5 рабочих дней);
- Экспресс доставка в любую точку России;
- Техническая поддержка проекта, помощь в подборе аналогов, поставка прототипов;
- Система менеджмента качества сертифицирована по Международному стандарту ISO 9001;
- Лицензия ФСБ на осуществление работ с использованием сведений, составляющих государственную тайну;
- Поставка специализированных компонентов (Xilinx, Altera, Analog Devices, Intersil, Interpoint, Microsemi, Aeroflex, Peregrine, Syfer, Eurofarad, Texas Instrument, Miteq, Cobham, E2V, MA-COM, Hittite, Mini-Circuits, General Dynamics и др.);

Помимо этого, одним из направлений компании «ЭлектроПласт» является направление «Источники питания». Мы предлагаем Вам помощь Конструкторского отдела:

- Подбор оптимального решения, техническое обоснование при выборе компонента;
- Подбор аналогов;
- Консультации по применению компонента;
- Поставка образцов и прототипов;
- Техническая поддержка проекта;
- Защита от снятия компонента с производства.



Как с нами связаться

Телефон: 8 (812) 309 58 32 (многоканальный)

Факс: 8 (812) 320-02-42

Электронная почта: org@eplast1.ru

Адрес: 198099, г. Санкт-Петербург, ул. Калинина, дом 2, корпус 4, литера А.