

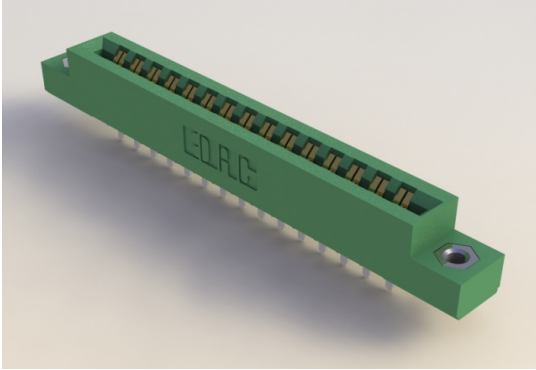

# 306/316/356 SERIES



## Card Edge Connector 0.156" (3.96mm) Pitch



### FEATURES:

- .156" (3.96mm) Contact Spacing with Single Centreline Row
- Accepts .062" (1.57mm) Nominal Thickness P.C. Board
- Low Profile Insulator Body, .460" (11.68mm)
- Contact Termination Options include P.C. Tail & Wire Hole
- Large Variety of Mounting Options
- Accepts between Contact and In-Contact Polarizing Keys
- Pre-assembled Card Guides are available
- RoHS Compliant & UL Recognize

### Specifications:

Insulator Material	UL 94V-0 Thermoplastic Polyester
Contact Material	Copper Alloy
Contact Plating	Gold Plating on mating area and Tin Plating on tails with Nickel underplating all over
Current Rating	5 Amperes
Contact Resistance	10 milliohms maximum
Dielectric Withstand Voltage	1800 VAC rms at sea level between adjacent contacts
Insulation Resistance	5000 Megohms minimum
Operating Temperature	-40°C to +105°C
Insertion Force	16oz (4.45N) maximum per contact pair when tested with .070" (1.78mm) thick gauge
Withdrawal Force	1oz (0.28N) minimum per contact pair when tested with .054" (1.37mm) thick gauge

Example Part Number: **306-022-521-178**

Series \_\_\_\_\_

Total Number of Contacts \_\_\_\_\_

Contact Code \_\_\_\_\_

Mounting Options \_\_\_\_\_

Series:	Insulator Color	Card Slot Length
306	Green	Standard Length per MIL-C-21097
316	Green	.020"(0.51mm) Shorter than Standard
356	Black	Standard Length per MIL-C-21097

### Ordering Code Notes:

- 1) All connector sizes up to 43 contacts dual row are available upon request.
- 2) For contacts with overall tin plating, change the first digit of the contact code from 5 to 4.
- 3) 5) For details of the mounting options refer to next pages.

**Total Number of Contacts:**  
006, 007, . . . . 043

**Contact Rows**  
Centre Row

Contact Code	Description & Tail Size	Tail Length "G"
500	Wire Hole .087 x .015 (2.21 x 0.38)	.282 (7.16)
520	P.C. Tail .046 x .015 (1.17 x 0.38)	.213 (5.41)
521	P.C. Tail .037 x .015 (0.94 x 0.38)	.125 (3.18)

IN-CONTACT  
POLARIZING KEY  
P/N 338-240-328

BETWEEN CONTACT  
POLARIZING KEY  
P/N 306-240-318

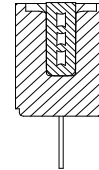
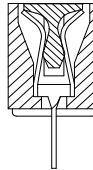

### Mounting Options:

Mounting Options:	Description
101	No Mounting Lug
102	Ø.128" (Ø3.25mm) Mounting Holes
103	Ø.116" (Ø2.95mm) I.D. Floating Eyelets
104	Ø.156" (Ø3.96mm) Mounting Holes
107	M3-0.5 Metric Threaded Inserts
108	#4-40 Unified Threaded Inserts
112	Ø.128" (Ø3.25mm) Side Mounting Holes
158	.468" (11.89mm) Offset Card Guides
168	.344 (8.74) Offset Card Guides
178	In-Line Card Guides

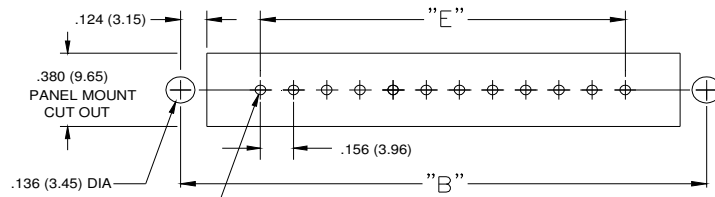
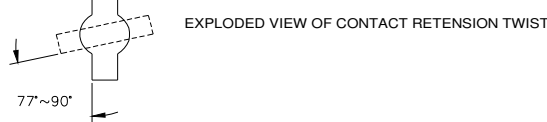
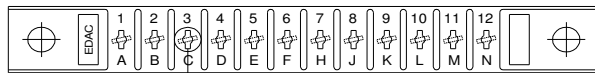
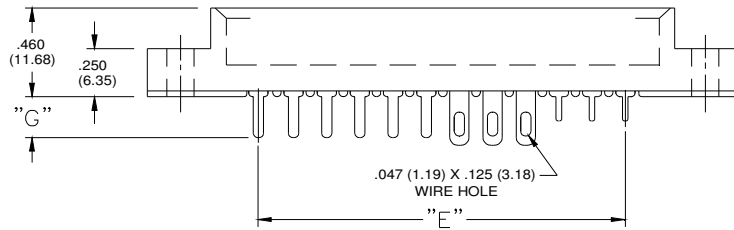
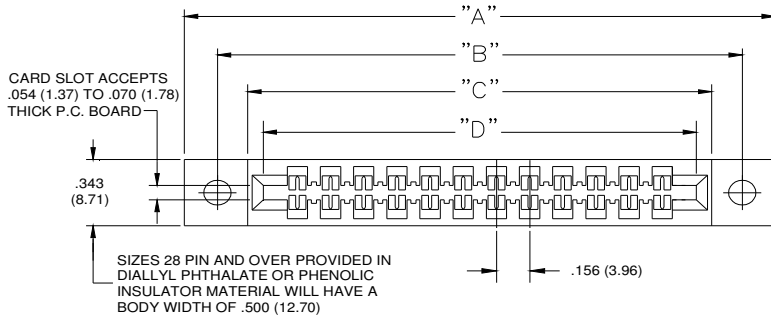

.050 (1.27) DIA +.004 (0.10) /-.000  
FOR CODE 520 P.C. TAIL  
.041 (1.04) DIA +.004 (0.10) /-.000  
FOR CODE 521 P.C. TAIL  
⌀ .008 (0.20) DIA

CONNECTOR MOUNTING PATTERN

SECTION THROUGH CONTACT POSITION

IN-CONTACT POLARIZING KEY  
P/N 338-240-328

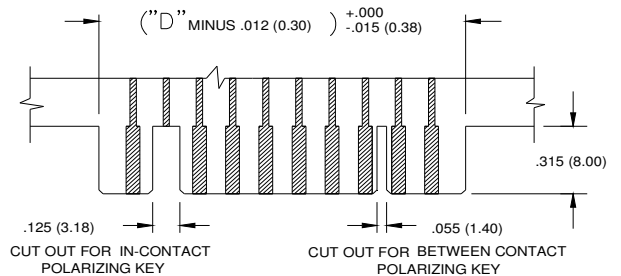
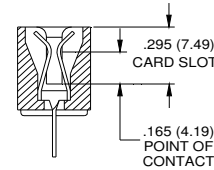

RECOMMENDED DAUGHTER BOARD

NUMBER OF CONTACTS	"A"		"B"		"C"		"D"				"E"	
	inch	mm	inch	mm	inch	mm	306,356		316		inch	mm
Single							inch	mm	inch	mm	inch	mm
6	1.842	46.79	1.532	38.91	1.246	31.65	1.100	27.94	1.080	27.43	0.780	19.81
8	2.154	54.71	1.844	46.84	1.558	39.57	1.412	35.86	1.392	35.36	1.092	27.74
10	2.466	62.64	2.156	54.76	1.87	47.50	1.724	43.79	1.704	43.28	1.404	35.66
12	2.778	70.56	2.468	62.69	2.182	55.42	2.036	51.71	2.016	51.21	1.716	43.59
15	3.246	82.45	2.936	74.57	2.65	67.31	2.504	63.60	2.484	63.09	2.184	55.47
18	3.714	94.34	3.404	86.46	3.118	79.20	2.972	75.49	2.952	74.98	2.652	67.36
22	4.338	110.19	4.028	102.31	3.742	95.05	3.596	91.34	3.576	90.83	3.276	83.21
25	4.806	122.07	4.496	114.20	4.21	106.93	4.064	103.23	4.044	102.72	3.744	95.10
28	5.274	133.96	4.964	126.09	4.678	118.82	4.532	115.11	4.512	114.60	4.212	106.98
30	5.586	141.88	5.276	134.01	4.99	126.75	4.844	123.04	4.824	122.53	4.524	114.91
36	6.522	165.66	6.212	157.78	5.926	150.52	5.780	146.81	5.760	146.30	5.460	138.68
40	7.146	181.51	6.836	173.63	6.55	166.37	6.404	162.66	6.384	162.15	6.084	154.53
43	7.614	193.40	7.304	185.52	7.018	178.26	6.872	174.55	6.852	174.04	6.552	166.42

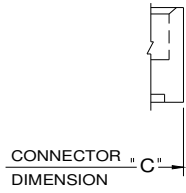

MOUNTING OPTION  
CODE x101  
(NO MOUNTING LUGS)

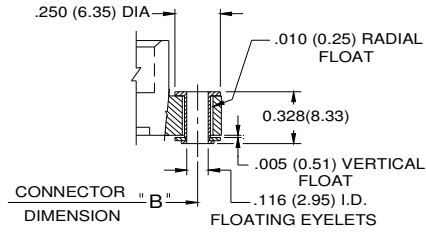

MOUNTING OPTION  
CODE x103  
(FLOATING EYELETS)

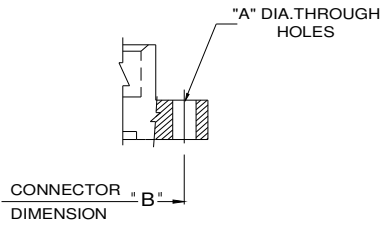

MOUNTING OPTION  
CODES x102 AND x104  
(THROUGH MOUNTING HOLES)

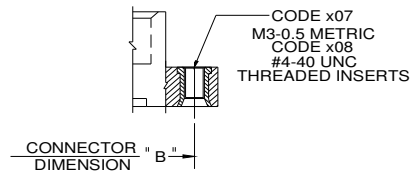

MOUNTING OPTION  
CODES x107 & x108  
(THREADED INSERTS)

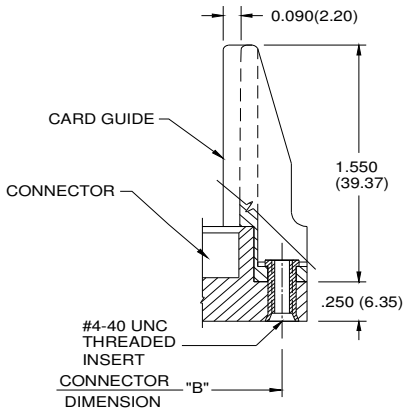

MOUNTING OPTION  
CODE x178  
(IN-LINE CARD GUIDE)

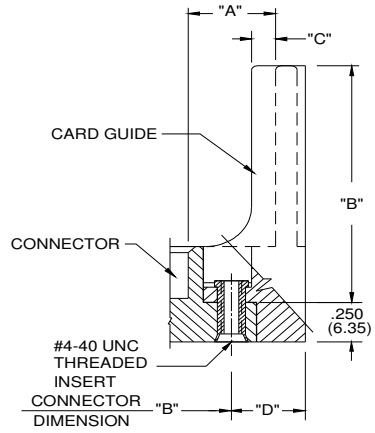

MOUNTING OPTION  
CODES x158 & x168  
(OFFSET CARD GUIDES)

CODE X102 AND X104- THROUGH MTG. HOLES			CODES X158 AND X168 OFFSET CARD GUIDES		
	CODE X102	CODE X104		CODE X158	CODE X168
"A" DIA.	0.128(3.25)	0.156(3.96)	"A"	0.468(11.89)	0.344(8.74)
CODE X107 AND X108- THREADED INSERTS			"B"	2.755(69.98)	2.505(63.63)
	CODE X107	CODE X108	"C"	0.125(3.18)	0.060(1.52)
INSERT	M3-0.5(METRIC)	#4-40 UNC	"D"	0.423(10.74)	0.242(6.15)



Компания «ЭлектроПласт» предлагает заключение долгосрочных отношений при поставках импортных электронных компонентов на взаимовыгодных условиях!

Наши преимущества:

- Оперативные поставки широкого спектра электронных компонентов отечественного и импортного производства напрямую от производителей и с крупнейших мировых складов;
- Поставка более 17-ти миллионов наименований электронных компонентов;
- Поставка сложных, дефицитных, либо снятых с производства позиций;
- Оперативные сроки поставки под заказ (от 5 рабочих дней);
- Экспресс доставка в любую точку России;
- Техническая поддержка проекта, помощь в подборе аналогов, поставка прототипов;
- Система менеджмента качества сертифицирована по Международному стандарту ISO 9001;
- Лицензия ФСБ на осуществление работ с использованием сведений, составляющих государственную тайну;
- Поставка специализированных компонентов (Xilinx, Altera, Analog Devices, Intersil, Interpoint, Microsemi, Aeroflex, Peregrine, Syfer, Eurofarad, Texas Instrument, Miteq, Cobham, E2V, MA-COM, Hittite, Mini-Circuits, General Dynamics и др.);

Помимо этого, одним из направлений компании «ЭлектроПласт» является направление «Источники питания». Мы предлагаем Вам помощь Конструкторского отдела:

- Подбор оптимального решения, техническое обоснование при выборе компонента;
- Подбор аналогов;
- Консультации по применению компонента;
- Поставка образцов и прототипов;
- Техническая поддержка проекта;
- Защита от снятия компонента с производства.



#### Как с нами связаться

**Телефон:** 8 (812) 309 58 32 (многоканальный)

**Факс:** 8 (812) 320-02-42

**Электронная почта:** [org@eplast1.ru](mailto:org@eplast1.ru)

**Адрес:** 198099, г. Санкт-Петербург, ул. Калинина, дом 2, корпус 4, литера А.