

## 1.25 A sensitive gate SCR

### Features

- on-state rms current: 1.25 A
- repetitive peak off-state voltage: 600 V and 800 V
- gate triggering current: 50 and 200  $\mu$ A

### Applications

- ground fault circuit interrupters
- overvoltage crowbar protection in power supplies
- capacitive ignition circuits

### Description

The X02 SCR can be used as the on/off function in applications where topology does not offer high current for gate triggering.

This device is optimized in forward voltage drop and inrush current capabilities for reduced power losses and high reliability in harsh environments.

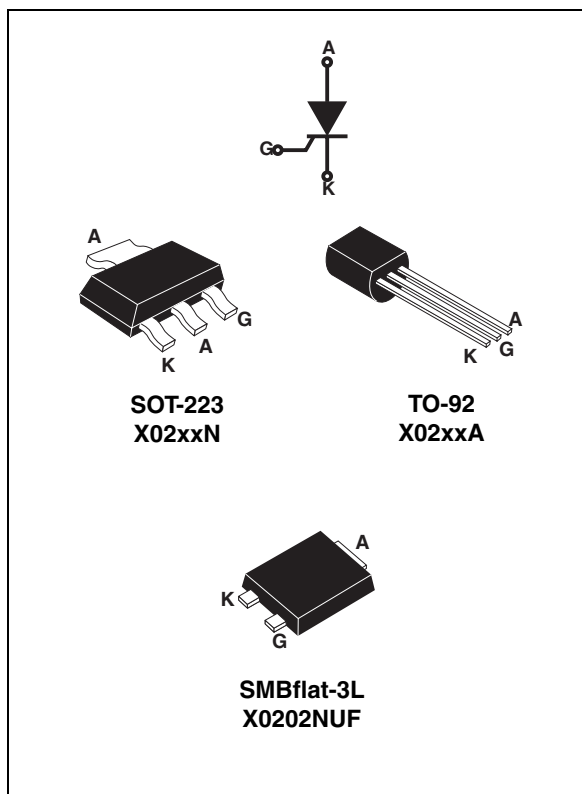

**Table 1. Device summary**

Order code	Voltage		Sensitivity $\mu$ A	Package
	600 V	800 V		
X0202MA	Y		200	TO-92
X0202MN	Y		200	SOT-223
X0202NA		Y	200	TO-92
X0202NN		Y	200	SOT-223
X0205MA	Y		50	TO-92
X0205NA		Y	50	TO-92
X0202NUF		Y	200	SMBflat-3L

# 1 Characteristics

**Table 2. Absolute ratings (limiting values,  $T_J = 25\text{ °C}$  unless otherwise specified)**

Symbol	Parameter		Value	Unit	
$I_{T(RMS)}$	On-state rms current (180 °Conduction angle)	TO-92	$T_L = 63\text{ °C}$	1.25	A
		SOT-223	$T_{tab} = 99\text{ °C}$		
		SMBflat-3L	$T_{tab} = 111\text{ °C}$		
$I_{T(AV)}$	Average on-state current (180 °Conduction angle)	TO-92	$T_L = 63\text{ °C}$	0.8	A
		SOT-223	$T_{tab} = 99\text{ °C}$		
		SMBflat-3L	$T_{tab} = 111\text{ °C}$		
$I_{TSM}$	Non repetitive surge peak on-state current	$t_p = 8.3\text{ ms}$	$T_J = 25\text{ °C}$	25	A
		$t_p = 10\text{ ms}$		22.5	
$I^2t$	$I^2t$ Value for fusing	$t_p = 10\text{ ms}$	$T_J = 25\text{ °C}$	2.5	$A^2s$
di/dt	Critical rate of rise of on-state current $I_G = 2 \times I_{GT}$ , $t_r \leq 100\text{ ns}$	F = 60 Hz	$T_J = 125\text{ °C}$	50	A/ $\mu s$
$I_{GM}$	Peak gate current	$t_p = 20\text{ }\mu s$	$T_J = 125\text{ °C}$	1.2	A
$P_{G(AV)}$	Average gate power dissipation		$T_J = 125\text{ °C}$	0.2	W
$T_{stg}$ $T_J$	Storage junction temperature range Operating junction temperature range			- 40 to + 150 - 40 to + 125	$^{\circ}C$

**Table 3. Electrical characteristics ( $T_J = 25\text{ °C}$  unless otherwise specified)**

Symbol	Test conditions		X0202	X0205	Unit	
$I_{GT}$	$V_D = 12\text{ V}$ , $R_L = 140\text{ }\Omega$	Min.		20	$\mu A$	
		Max.	200	50		
$V_{GT}$		Max.	0.8		V	
$V_{GD}$	$V_D = V_{DRM}$ , $R_L = 3.3\text{ k}\Omega$ , $R_{GK} = 1\text{ k}\Omega$	$T_J = 125\text{ °C}$	Min.	0.1		V
$V_{RG}$	$I_{RG} = 10\text{ }\mu A$		Min.	8		V
$I_H$	$I_T = 50\text{ mA}$ , $R_{GK} = 1\text{ k}\Omega$		Max.	5		mA
$I_L$	$I_G = 1\text{ mA}$ , $R_{GK} = 1\text{ k}\Omega$		Max.	6		mA
dV/dt	$V_D = 67\% V_{DRM}$ , $R_{GK} = 1\text{ k}\Omega$	$T_J = 110\text{ °C}$	Min.	10	15	V/ $\mu s$

**Table 4. Static electrical characteristics**

Symbol	Test conditions		X0202	X0205	Unit
$V_{TM}$	$I_{TM} = 2.5\text{ A}$ , $t_p = 380\text{ }\mu s$	$T_J = 25\text{ °C}$	1.45		V
$V_{TO}$	Threshold voltage	$T_J = 125\text{ °C}$	0.9		V
$R_d$	Dynamic resistance		Max.	200	
$I_{DRM}$ $I_{RRM}$	$V_{DRM} = V_{RRM}$ , $R_{GK} = 1\text{ k}\Omega$	$T_J = 25\text{ °C}$	5		$\mu A$
		$T_J = 125\text{ °C}$	500		$\mu A$

**Table 5. Thermal resistances**

Symbol	Parameter		Value	Unit
$R_{th(j-l)}$	Junction to leads (DC)	TO-92	Max.	°C/W
$R_{th(j-t)}$	Junction to tab (DC)	SOT-223		
$R_{th(j-t)}$	Junction to tab (DC)	SMBflat-3L		
$R_{th(j-a)}$	Junction to ambient (DC)	S = 5 cm <sup>2</sup>	TO-92	150
			SOT-223	60
			SMBflat-3L	75

**Figure 1. Maximum average power dissipation versus average on-state current (full cycle)**

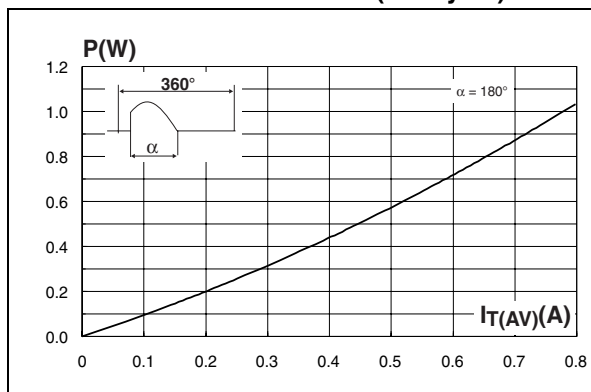

**Figure 2. Average and DC on-state current versus tab (SOT-223, SMBflat-3L) or lead (TO-92) temperature**

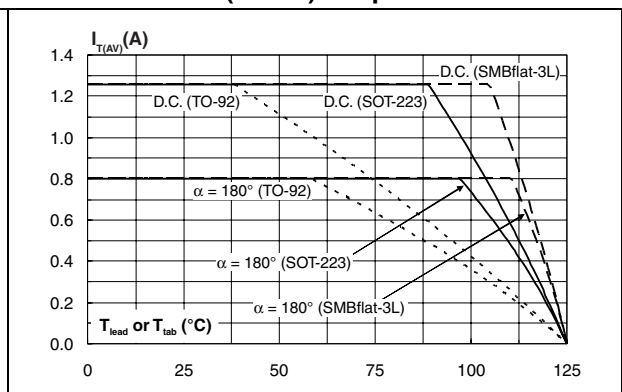

**Figure 3. Average and DC on-state current versus ambient temperature**

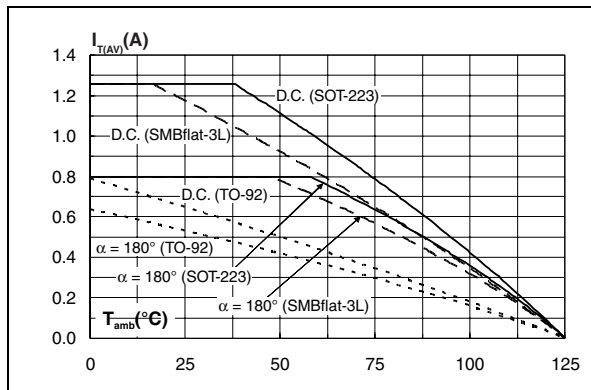

**Figure 4. Relative variation of thermal impedance junction to ambient versus pulse duration**

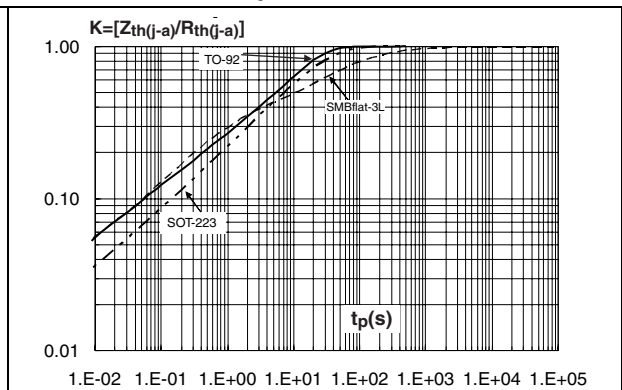

**Figure 5. Relative variation of triggering, holding and latching current versus junction temperature**

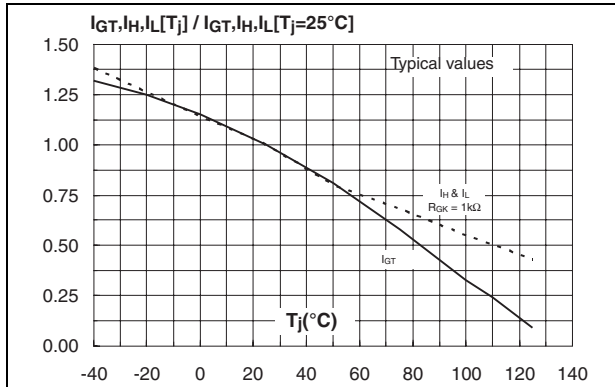

**Figure 6. Relative variation of holding current versus gate-cathode resistance (typical values)**

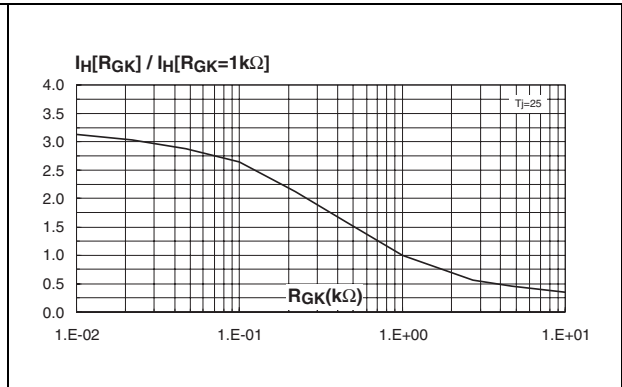

**Figure 7. Relative variation of dV/dt immunity versus gate-cathode resistance (typical values)**

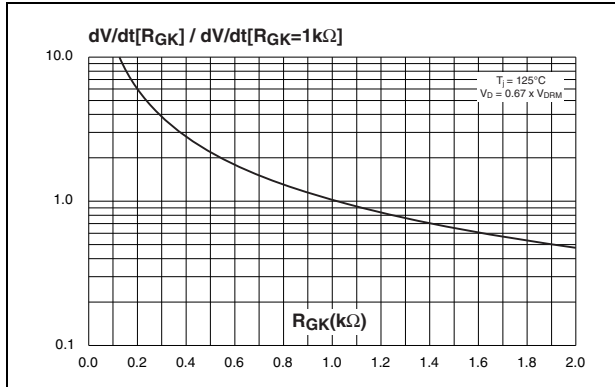

**Figure 8. Relative variation of dV/dt immunity versus gate-cathode capacitance (typical values)**

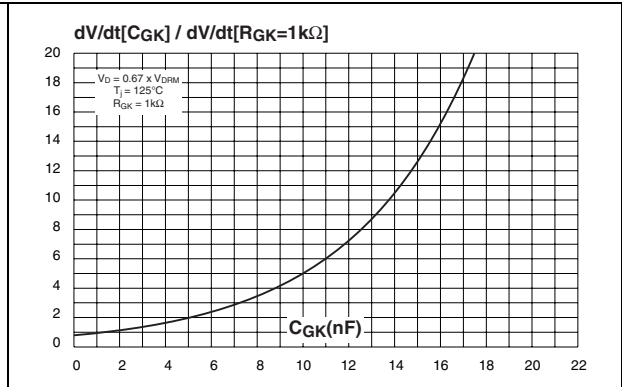

**Figure 9. Surge peak on-state current versus number of cycles**

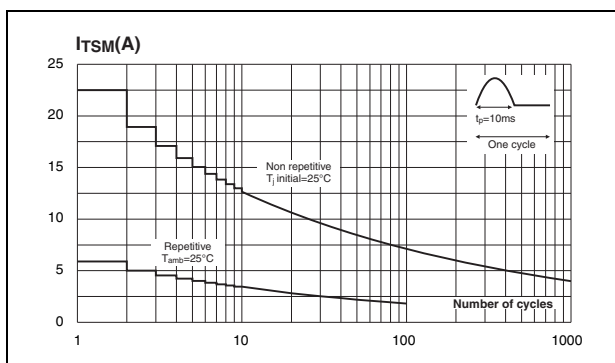

**Figure 10. Non repetitive surge peak on state current for a sinusoidal pulse and corresponding value of  $I^2T$**

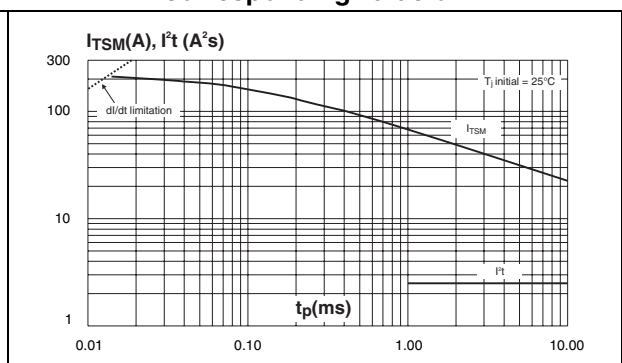

Figure 11. On-state characteristics (maximum values)

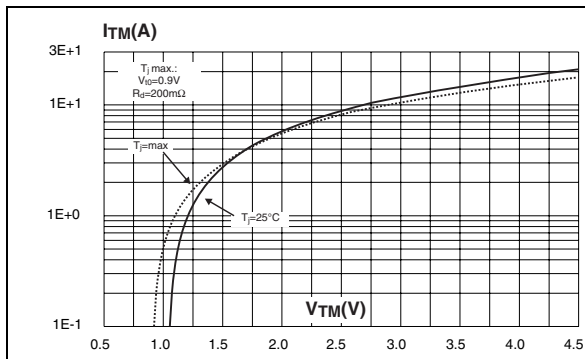
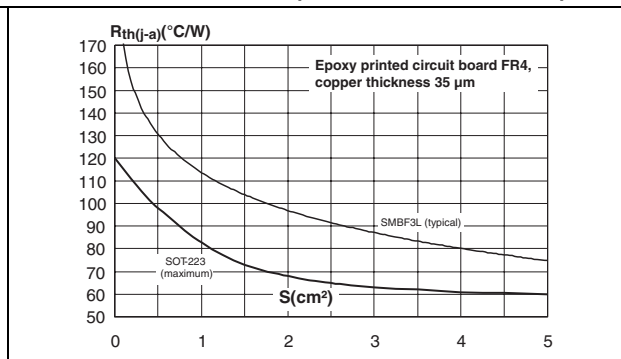
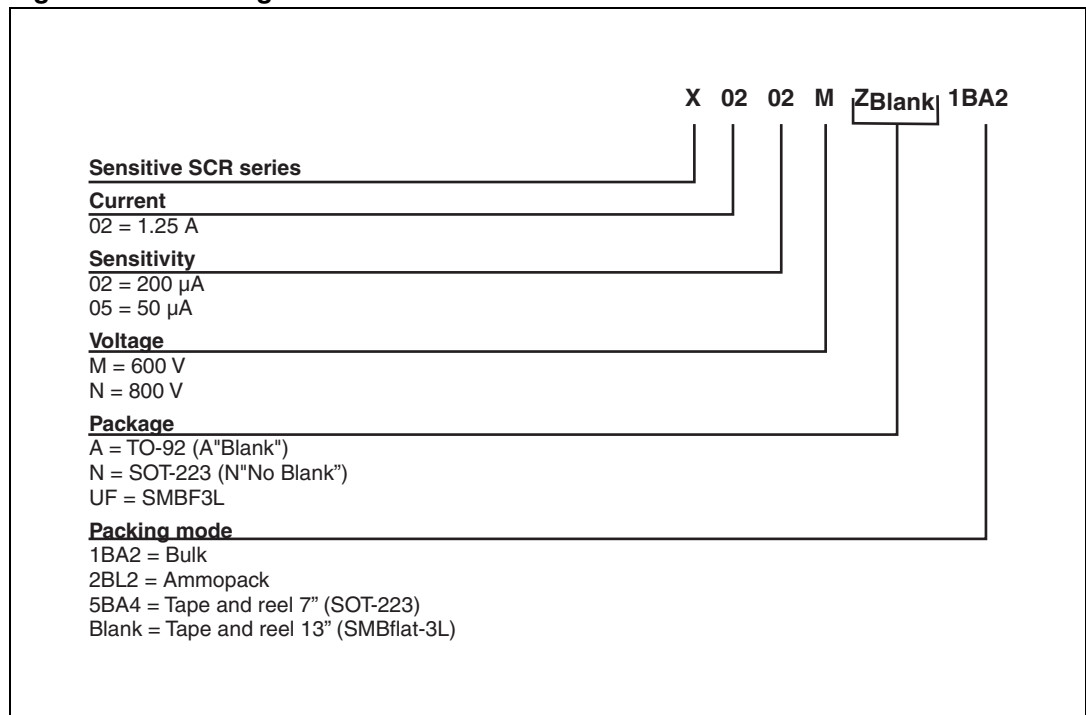

Figure 12. Thermal resistance junction to ambient versus copper surface under tab (SOT-223, SMBflat-3L)



## 2 Ordering information scheme

Figure 13. Ordering information scheme



### 3 Package information

- Epoxy meets UL94, V0
- Lead-free packages

In order to meet environmental requirements, ST offers these devices in different grades of ECOPACK® packages, depending on their level of environmental compliance. ECOPACK® specifications, grade definitions and product status are available at: [www.st.com](http://www.st.com). ECOPACK® is an ST trademark.

**Table 6. TO-92 dimensions**

Ref	Dimensions					
	Millimeters			Inches		
	Min.	Typ.	Max.	Min.	Typ.	Max.
A		1.35			0.053	
B			4.70			0.185
C		2.54			0.100	
D	4.40			0.173		
E	12.70			0.500		
F			3.70			0.146
a			0.50			0.019

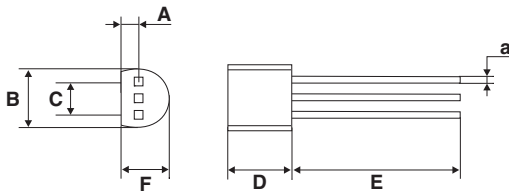
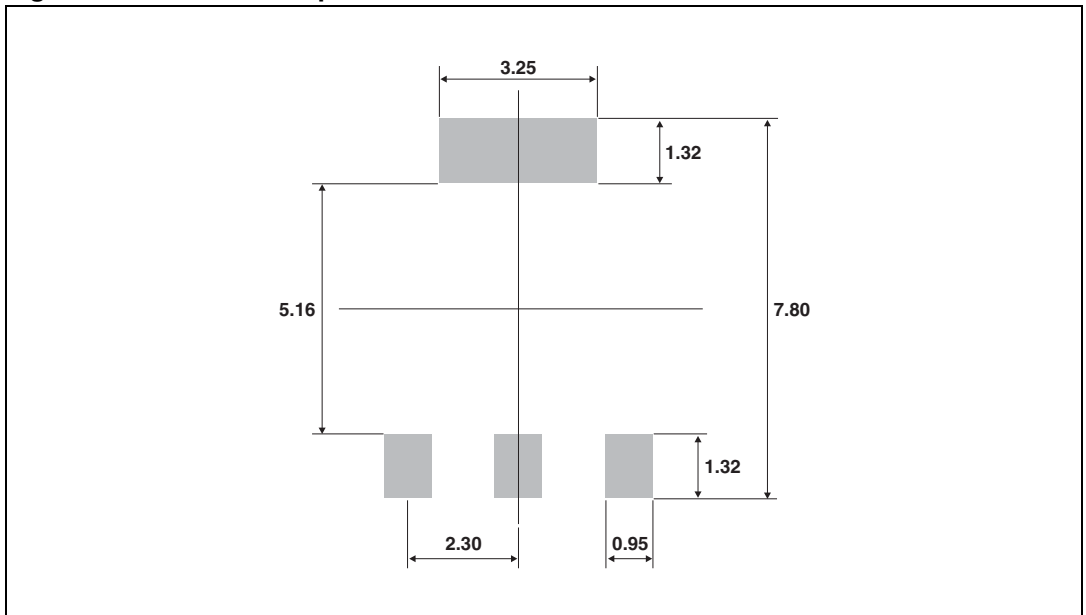

Table 7. SOT-223 dimensions

Ref.	Dimensions					
	Millimeters			Inches		
	Min.	Typ.	Max.	Min.	Typ.	Max.
A			1.80			0.071
A1		0.02	0.10		0.001	0.004
B	0.60	0.70	0.85	0.024	0.027	0.033
B1	2.90	3.00	3.15	0.114	0.118	0.124
c	0.24	0.26	0.35	0.009	0.010	0.014
D <sup>(1)</sup>	6.30	6.50	6.70	0.248	0.256	0.264
e		2.3			0.090	
e1		4.6			0.181	
E <sup>(1)</sup>	3.30	3.50	3.70	0.130	0.138	0.146
H	6.70	7.00	7.30	0.264	0.276	0.287
V	10° max					

1. Do not include mold flash or protrusions. Mold flash or protrusions shall not exceed 0.15mm (0.006inches)

Figure 14. SOT-223 footprint



**Table 8. SMBflat-3L dimensions**

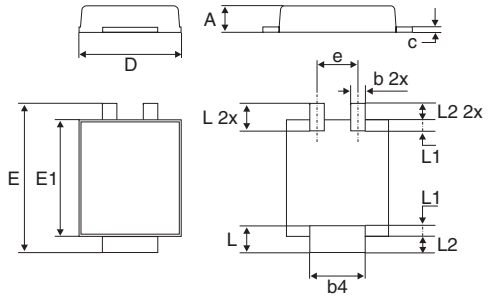

Ref.	Dimensions					
	Millimeters			Inches		
	Min.	Typ.	Max.	Min.	Typ.	Max.
A	0.90		1.10	0.035		0.043
b	0.35		0.65	0.014		0.026
b4	1.95		2.20	0.07		0.087
c	0.15		0.40	0.006		0.016
D	3.30		3.95	0.130		0.156
E	5.10		5.60	0.201		0.220
E1	4.05		4.60	0.156		0.181
L	0.75		1.50	0.030		0.059
L1		0.40			0.016	
L2		0.60			0.024	
e		1.60			0.063	

**Figure 15. SMBflat-3L footprint dimensions**

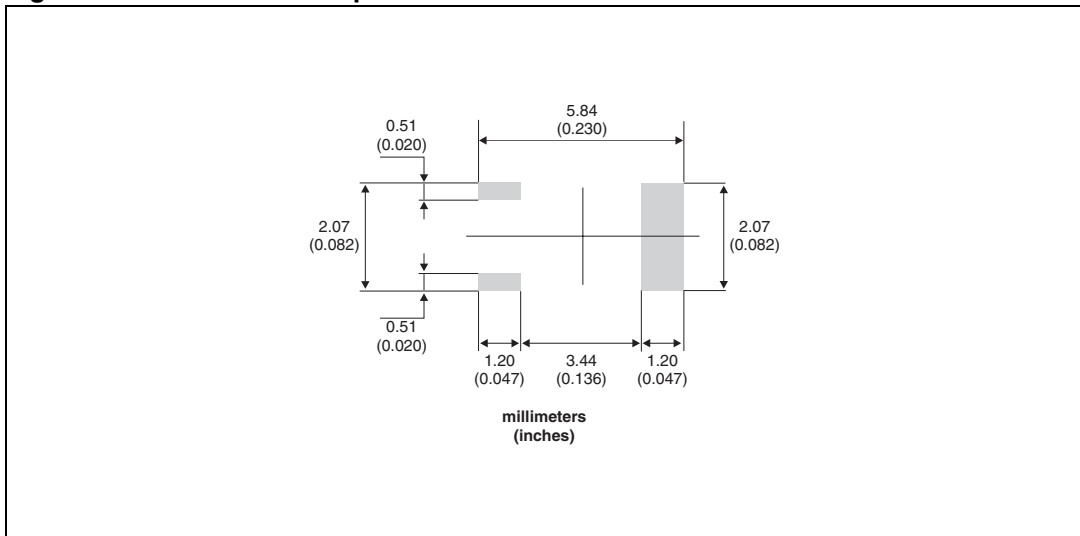
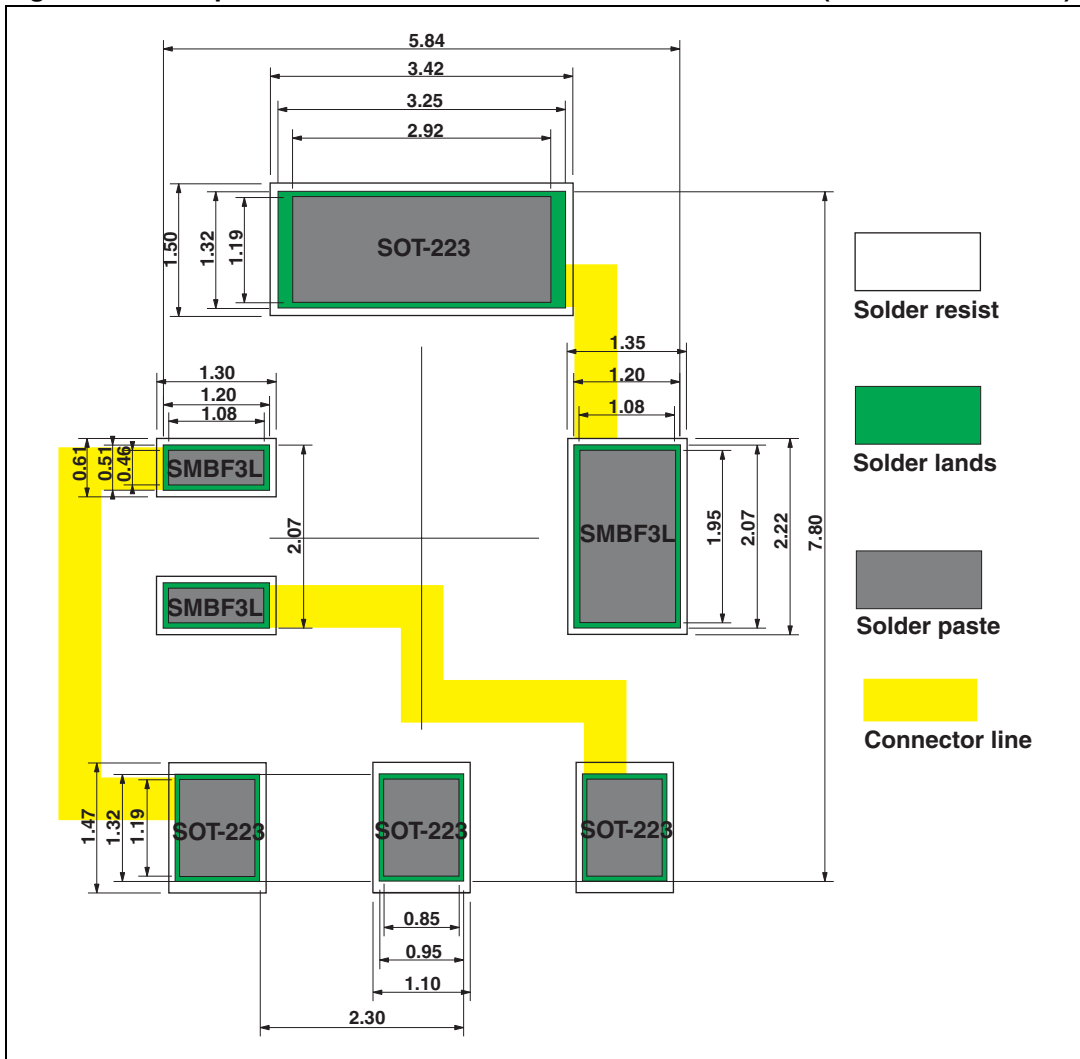



Figure 16. Footprint and connectors for SOT-223 or SMBflat-3L (dimensions in mm)



## 4 Ordering information

**Table 9. Ordering information**

Order code	Marking	Package	Weight	Base qty	Delivery mode
X0202MA 1BA2	X0202 MA	TO-92	0.2 g	2500	Bulk
X0202MA 2BL2	X0202 MA	TO-92	0.2 g	2000	Ammopack
X0202MN5BA4	X2M	SOT-223	0.12 g	1000	Tape and reel
X0202NA 1BA2	X0202 NA	TO-92	0.2 g	2500	Bulk
X0202NA 2BL2	X0202 NA	TO-92	0.2 g	2000	Ammopack
X0202NN5BA4	X2N	SOT-223	0.12 g	1000	Tape and reel
X0205MA 1BA2	X0205 MA	TO-92	0.2 g	2500	Bulk
X0205MA 2BL2	X0205 MA	TO-92	0.2 g	2000	Ammopack
X0205NA 1BA2	X0205 NA	TO-92	0.2 g	2500	Bulk
X0202NUF	X2N	SMBflat-3L	46.914 mg	5000	Tape and reel

## 5 Revision history

**Table 10. Document revision history**

Date	Revision	Changes
Sep-2000	3	Previous issue
14-Jan-2011	4	Added SMBflat-3L package and ECOPACK statement.

**Please Read Carefully:**

Information in this document is provided solely in connection with ST products. STMicroelectronics NV and its subsidiaries ("ST") reserve the right to make changes, corrections, modifications or improvements, to this document, and the products and services described herein at any time, without notice.

All ST products are sold pursuant to ST's terms and conditions of sale.

Purchasers are solely responsible for the choice, selection and use of the ST products and services described herein, and ST assumes no liability whatsoever relating to the choice, selection or use of the ST products and services described herein.

No license, express or implied, by estoppel or otherwise, to any intellectual property rights is granted under this document. If any part of this document refers to any third party products or services it shall not be deemed a license grant by ST for the use of such third party products or services, or any intellectual property contained therein or considered as a warranty covering the use in any manner whatsoever of such third party products or services or any intellectual property contained therein.

**UNLESS OTHERWISE SET FORTH IN ST'S TERMS AND CONDITIONS OF SALE ST DISCLAIMS ANY EXPRESS OR IMPLIED WARRANTY WITH RESPECT TO THE USE AND/OR SALE OF ST PRODUCTS INCLUDING WITHOUT LIMITATION IMPLIED WARRANTIES OF MERCHANTABILITY, FITNESS FOR A PARTICULAR PURPOSE (AND THEIR EQUIVALENTS UNDER THE LAWS OF ANY JURISDICTION), OR INFRINGEMENT OF ANY PATENT, COPYRIGHT OR OTHER INTELLECTUAL PROPERTY RIGHT.**

**UNLESS EXPRESSLY APPROVED IN WRITING BY AN AUTHORIZED ST REPRESENTATIVE, ST PRODUCTS ARE NOT RECOMMENDED, AUTHORIZED OR WARRANTED FOR USE IN MILITARY, AIR CRAFT, SPACE, LIFE SAVING, OR LIFE SUSTAINING APPLICATIONS, NOR IN PRODUCTS OR SYSTEMS WHERE FAILURE OR MALFUNCTION MAY RESULT IN PERSONAL INJURY, DEATH, OR SEVERE PROPERTY OR ENVIRONMENTAL DAMAGE. ST PRODUCTS WHICH ARE NOT SPECIFIED AS "AUTOMOTIVE GRADE" MAY ONLY BE USED IN AUTOMOTIVE APPLICATIONS AT USER'S OWN RISK.**

Resale of ST products with provisions different from the statements and/or technical features set forth in this document shall immediately void any warranty granted by ST for the ST product or service described herein and shall not create or extend in any manner whatsoever, any liability of ST.

ST and the ST logo are trademarks or registered trademarks of ST in various countries.

Information in this document supersedes and replaces all information previously supplied.

The ST logo is a registered trademark of STMicroelectronics. All other names are the property of their respective owners.

© 2011 STMicroelectronics - All rights reserved

STMicroelectronics group of companies

Australia - Belgium - Brazil - Canada - China - Czech Republic - Finland - France - Germany - Hong Kong - India - Israel - Italy - Japan - Malaysia - Malta - Morocco - Philippines - Singapore - Spain - Sweden - Switzerland - United Kingdom - United States of America

[www.st.com](http://www.st.com)



Компания «ЭлектроПласт» предлагает заключение долгосрочных отношений при поставках импортных электронных компонентов на взаимовыгодных условиях!

Наши преимущества:

- Оперативные поставки широкого спектра электронных компонентов отечественного и импортного производства напрямую от производителей и с крупнейших мировых складов;
- Поставка более 17-ти миллионов наименований электронных компонентов;
- Поставка сложных, дефицитных, либо снятых с производства позиций;
- Оперативные сроки поставки под заказ (от 5 рабочих дней);
- Экспресс доставка в любую точку России;
- Техническая поддержка проекта, помощь в подборе аналогов, поставка прототипов;
- Система менеджмента качества сертифицирована по Международному стандарту ISO 9001;
- Лицензия ФСБ на осуществление работ с использованием сведений, составляющих государственную тайну;
- Поставка специализированных компонентов (Xilinx, Altera, Analog Devices, Intersil, Interpoint, Microsemi, Aeroflex, Peregrine, Syfer, Eurofarad, Texas Instrument, Miteq, Cobham, E2V, MA-COM, Hittite, Mini-Circuits, General Dynamics и др.);

Помимо этого, одним из направлений компании «ЭлектроПласт» является направление «Источники питания». Мы предлагаем Вам помощь Конструкторского отдела:

- Подбор оптимального решения, техническое обоснование при выборе компонента;
- Подбор аналогов;
- Консультации по применению компонента;
- Поставка образцов и прототипов;
- Техническая поддержка проекта;
- Защита от снятия компонента с производства.



#### Как с нами связаться

**Телефон:** 8 (812) 309 58 32 (многоканальный)

**Факс:** 8 (812) 320-02-42

**Электронная почта:** [org@eplast1.ru](mailto:org@eplast1.ru)

**Адрес:** 198099, г. Санкт-Петербург, ул. Калинина, дом 2, корпус 4, литера А.