



SUCCESSIVE DETECTION LOG VIDEO AMPLIFIER (SDLVA), 0.5 - 18.5 GHz

Typical Applications

The HMC1013LP4E is ideal for:

- EW, ELINT & IFM Receivers
- DF Radar Systems
- ECM Systems
- Broadband Test & Measurement
- Power Measurement & Control Circuits
- Military & Space Applications

Features

- High Logging Range: 67 dB (-62 to +5 dBm)
- Output Frequency Flatness: ± 2 dB
- Log Linearity: ± 2 dB
- Fast Rise/Fall Times: 5/15 ns
- Single Positive Supply: +3.3V
- ESD Sensitivity (HBM): Class 1A
- 24 Lead 4x4mm SMT Package: 16mm²

Functional Diagram

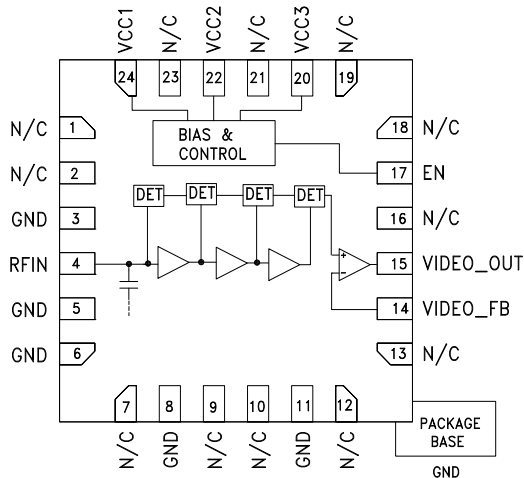

General Description

The HMC1013LP4E is a Successive Detection Log Video Amplifier which operates from 0.5 to 18.5 GHz. The HMC1013LP4E provides a logging range of 67 dB. This device offers typical fast rise/fall times of 5/15 ns and a superior delay time of only 10 ns. The HMC1013LP4E log video output slope is typically 15 mV/dB. Maximum recovery times are less than 40 ns. The HMC1013LP4E is available in a highly compact 4x4 mm SMT plastic package and is ideal for high speed channelized receiver applications.

Electrical Specifications, $T_A = +25^\circ\text{C}$ $V_{cc1} = V_{cc2} = V_{cc3} = +3.3\text{V}$, $EN=3.3\text{V}$

Parameter	Conditions	Typ.	Units
Input Frequency Range [1]		0.5 - 18.5	GHz
Frequency Flatness		± 2	dB
Log Linearity	Pin = -60 to +5 dBm	± 2	dB
Log Linearity over Temperature		± 2	dB
Minimum Logging Range	to ± 3 dB error	-62	dBm
Maximum Logging Range	to ± 3 dB error	+5	dBm
Input Return Loss		8	dB
Log Video Minimum Output Voltage		0.9	V
Log Video Maximum Output Voltage		1.9	V
Log Video Output Rise Time	10% to 90%	5	ns
Log Video Output Fall Time	90% to 10%	15	ns
Log Video Recovery Time	@ 10 GHz	38	ns
Log Video Output Slope		15	mV/dB
Log Video Output Slope Variation over Temperature	@ 10 GHz	6.2	$\mu\text{V/dB}^\circ\text{C}$
Log Video Propagation Delay		10	ns
Supply Current (Icc1)		7	mA
Supply Current (Icc2)		90	mA
Supply Current (Icc3)		86	mA

[1] Video output load should be 1K Ohm or higher.

Information furnished by Analog Devices is believed to be accurate and reliable. However, no responsibility is assumed by Analog Devices for its use, nor for any infringements of patents or other rights of third parties that may result from its use. Specifications subject to change without notice. No license is granted by implication or otherwise under any patent or patent rights of Analog Devices. Trademarks and registered trademarks are the property of their respective owners.

For price, delivery, and to place orders: Analog Devices, Inc., One Technology Way, P.O. Box 9106, Norwood, MA 02062-9106
 Phone: 781-329-4700 • Order online at www.analog.com
 Application Support: Phone: 1-800-ANALOG-D



SUCCESSIVE DETECTION LOG VIDEO AMPLIFIER (SDLVA), 0.5 - 18.5 GHz

Error Flatness vs. Input Power Over Frequency [1] [2]

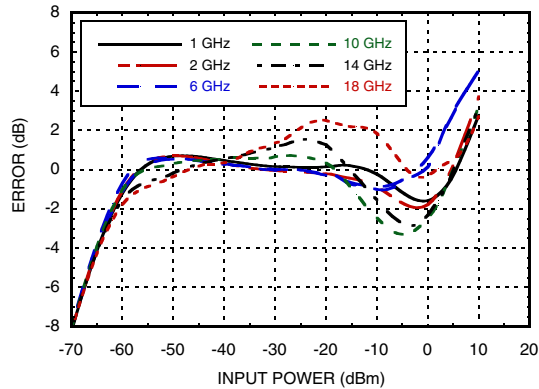

VIDEO OUT & Error vs. Input Power, Fin = 500 MHz

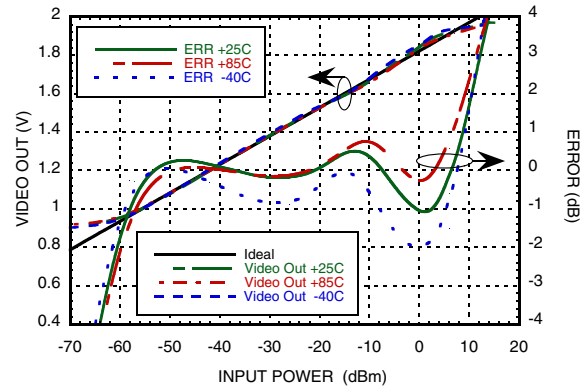

VIDEO OUT & Error vs. Input Power, Fin = 1 GHz

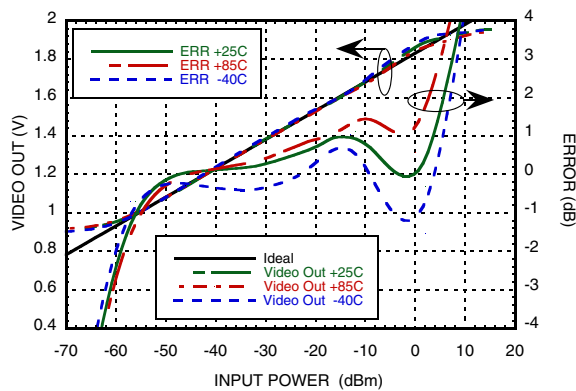

VIDEO OUT & Error vs. Input Power, Fin = 2 GHz

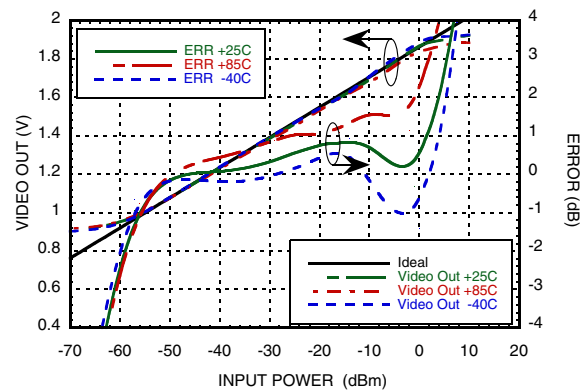

VIDEO OUT & Error vs. Input Power, Fin = 6 GHz

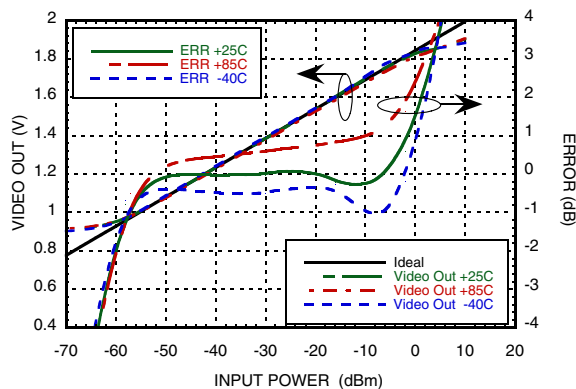

VIDEO OUT & Error vs. Input Power, Fin = 10 GHz

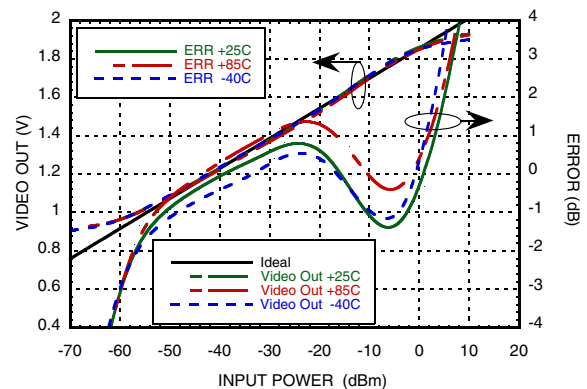

[1] An average ideal line is used to calculate error curves.
[2] At 25°C.



SUCCESSIVE DETECTION LOG VIDEO AMPLIFIER (SDLVA), 0.5 - 18.5 GHz

VIDEO OUT & Error vs. Input Power, $F_{in} = 14$ GHz

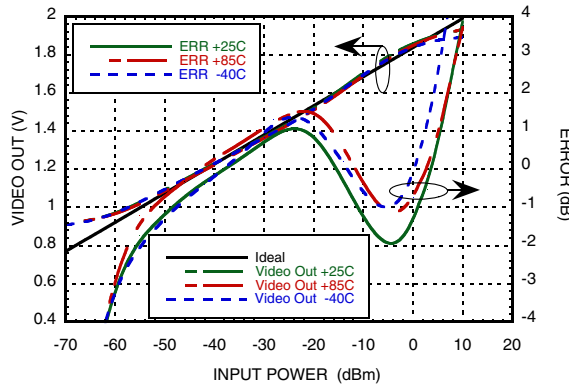

VIDEO OUT & Error vs. Input Power, $F_{in} = 18$ GHz

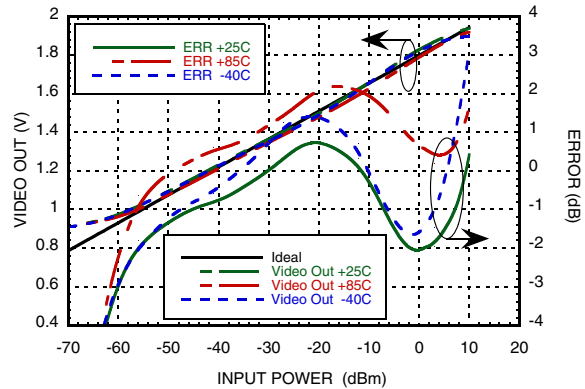

VIDEO OUT & Error vs. Input Power, $F_{in} = 20$ GHz

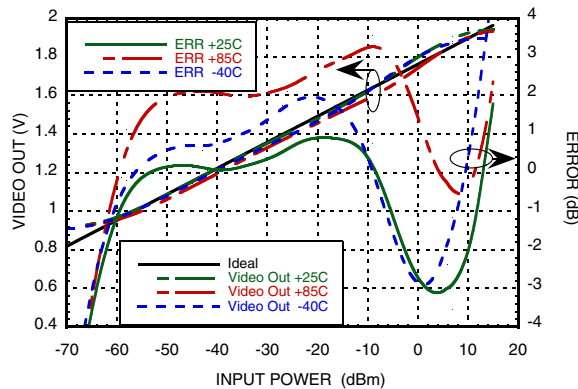

VIDEO OUT vs. Frequency Over Input Power & Temperature

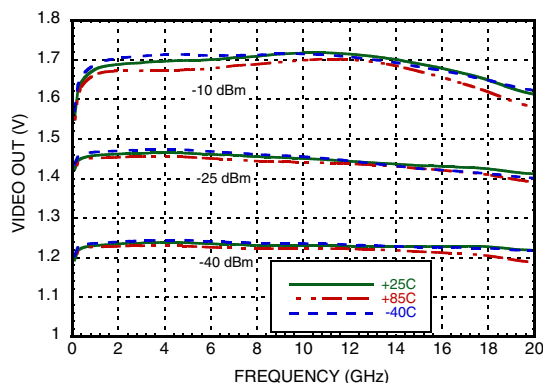

VIDEO OUT vs. Frequency Over Input Power & Bias Voltage

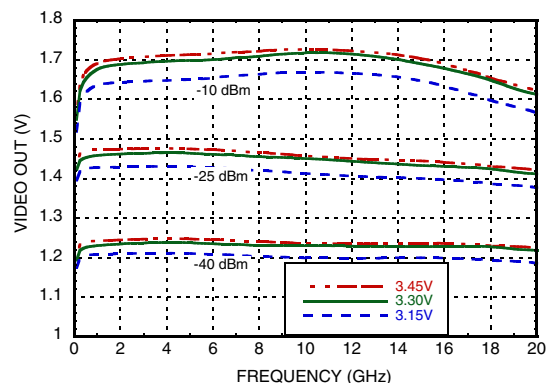

Information furnished by Analog Devices is believed to be accurate and reliable. However, no responsibility is assumed by Analog Devices for its use, nor for any infringements of patents or other rights of third parties that may result from its use. Specifications subject to change without notice. No license is granted by implication or otherwise under any patent or patent rights of Analog Devices. Trademarks and registered trademarks are the property of their respective owners.

For price, delivery, and to place orders: Analog Devices, Inc., One Technology Way, P.O. Box 9106, Norwood, MA 02062-9106 Phone: 781-329-4700 • Order online at www.analog.com Application Support: Phone: 1-800-ANALOG-D



**SUCCESSIVE DETECTION LOG VIDEO
AMPLIFIER (SDLVA), 0.5 - 18.5 GHz**

**Fall Time for Various Frequencies
@ 0 dBm**

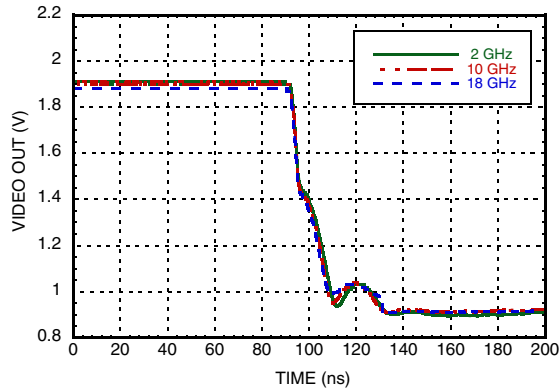

**Rise Time for Various Frequencies
@ 0 dBm**

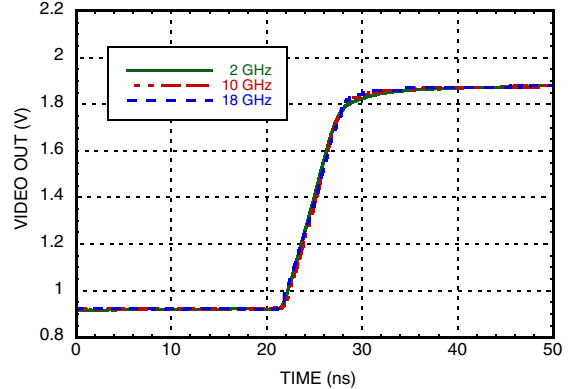

Input Return Loss vs. Frequency

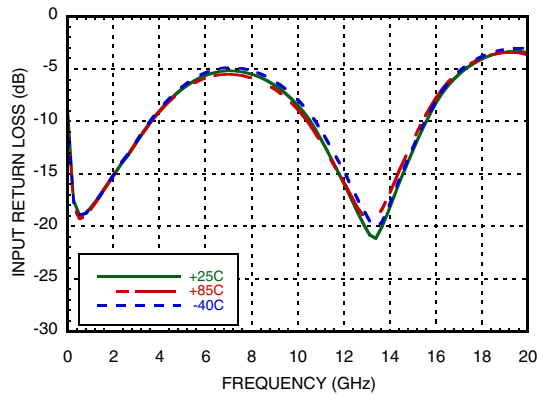

Absolute Maximum Ratings

Vcc	+3.6V
Enable	+3.6V
RF Input Power	+13 dBm
Junction Temperature	125 °C
Continuous P _{diss} (T=85 °C) Derate 35.22 mW/°C above 85 °C	1.41 W
Thermal Resistance (R _{thj}) (junction to package bottom)	28.4 °C/W
Storage Temperature	-65 to +150 °C
Operating Temperature	-40 to +85 °C
ESD Sensitivity (HBM)	Class 1A



**ELECTROSTATIC SENSITIVE DEVICE
OBSERVE HANDLING PRECAUTIONS**



SUCCESSIVE DETECTION LOG VIDEO AMPLIFIER (SDLVA), 0.5 - 18.5 GHz

Outline Drawing

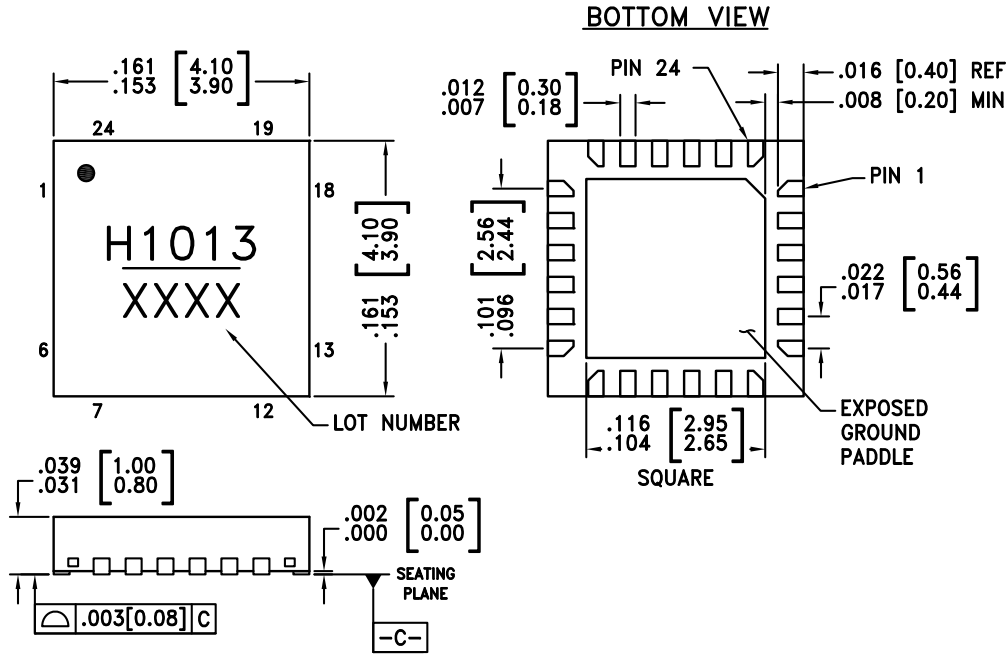

NOTES:

1. PACKAGE BODY MATERIAL: LOW STRESS INJECTION MOLDED PLASTIC SILICA AND SILICON IMPREGNATED.
2. LEAD AND GROUND PADDLE MATERIAL: COPPER ALLOY.
3. LEAD AND GROUND PADDLE PLATING: 100% MATTE TIN
4. DIMENSIONS ARE IN INCHES [MILLIMETERS].
5. LEAD SPACING TOLERANCE IS NON-CUMULATIVE.
6. CHARACTERS TO BE HELVETICA MEDIUM, .025 HIGH, WHITE INK, OR LASER MARK LOCATED APPROX. AS SHOWN.
7. PAD BURR LENGTH SHALL BE 0.15mm MAX. PAD BURR HEIGHT SHALL BE 0.05mm MAX.
8. PACKAGE WARP SHALL NOT EXCEED 0.05mm
9. ALL GROUND LEADS AND GROUND PADDLE MUST BE SOLDERED TO PCB RF GROUND.
10. REFER TO HITTITE APPLICATION NOTE FOR SUGGESTED PCB LAND PATTERN

Package Information

Part Number	Package Body Material	Lead Finish	MSL Rating	Package Marking ^[1]
HMC1013LP4E	RoHS-compliant Low Stress Injection Molded Plastic	100% matte Sn	MSL1 ^[2]	H1013 XXXX

[1] 4-Digit lot number XXXX

[2] Max peak reflow temperature of 260 °C



SUCCESSIVE DETECTION LOG VIDEO AMPLIFIER (SDLVA), 0.5 - 18.5 GHz

Pin Descriptions

Pin Number	Function	Description	Interface Schematic
1-2, 7, 9-10, 12-13, 16, 18-19, 21, 23	N/C	The pins are not connected internally; however, all data shown herein was measured with these pins connected to RF/DC ground externally.	
3, 5-6, 8, 11	GND	These pins and the exposed package bottom must be connected to a high quality RF/DC ground.	
4	RFIN	RF Input pin	
14, 15	VIDEO_FB VIDEO_OUT	Video out and feedback. These pins should be shorted to each other (see application circuit). Video out load should be at least 1K Ohm or higher.	
17	EN	Enable pin, connect to 3.3V supply for normal operation. Total supply current reduced to less than 11mA when EN is set to 0V.	
20	VCC3	Bias Supply. Connect supply voltage to these pins with appropriate filtering. See application circuit To ensure proper start-up supply rise time should be faster than 100usec.	

Information furnished by Analog Devices is believed to be accurate and reliable. However, no responsibility is assumed by Analog Devices for its use, nor for any infringements of patents or other rights of third parties that may result from its use. Specifications subject to change without notice. No license is granted by implication or otherwise under any patent or patent rights of Analog Devices. Trademarks and registered trademarks are the property of their respective owners.

For price, delivery, and to place orders: Analog Devices, Inc., One Technology Way, P.O. Box 9106, Norwood, MA 02062-9106
Phone: 781-329-4700 • Order online at www.analog.com
Application Support: Phone: 1-800-ANALOG-D



SUCCESSIVE DETECTION LOG VIDEO AMPLIFIER (SDLVA), 0.5 - 18.5 GHz

Pin Descriptions (continued)

Pin Number	Function	Description	Interface Schematic
22, 24	VCC2, VCC1	Bias Supply. Connect Supply Voltage to these pins with appropriate filtering. Connect Vcc2 with Vcc1. See application circuit. To ensure proper start-up supply rise time should be faster than 100usec.	

Application Circuit

PLACE THESE AS CLOSE TO THE PACKAGE AS POSSIBLE

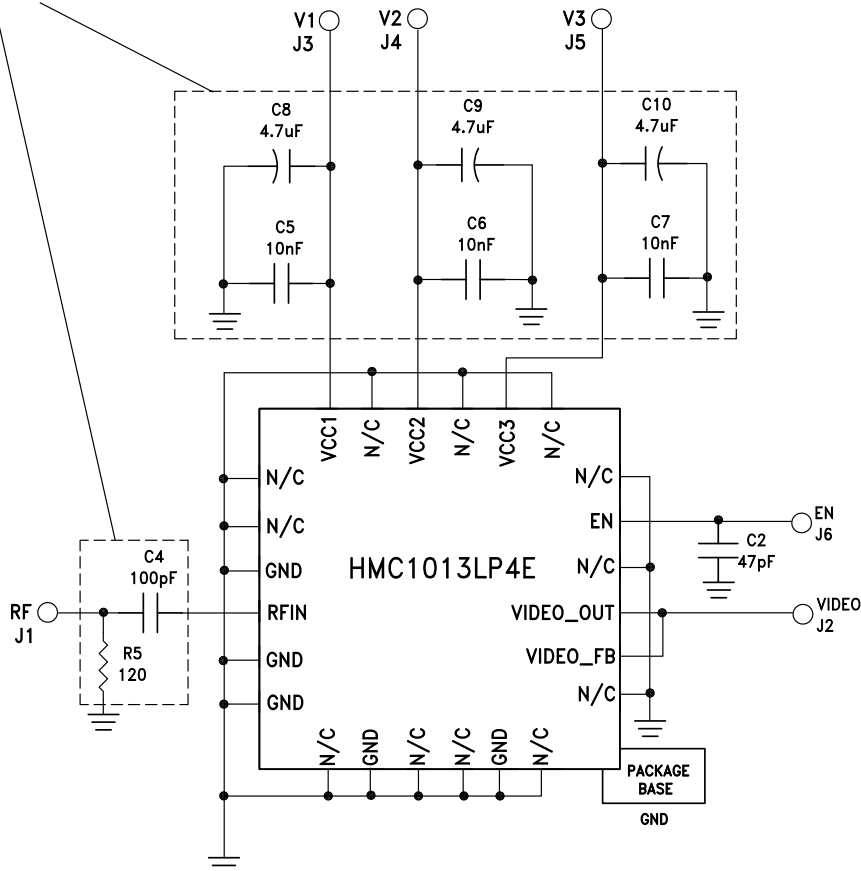

Note: Video output load should be 1K Ohm or higher.



SUCCESSIVE DETECTION LOG VIDEO AMPLIFIER (SDLVA), 0.5 - 18.5 GHz

Evaluation PCB

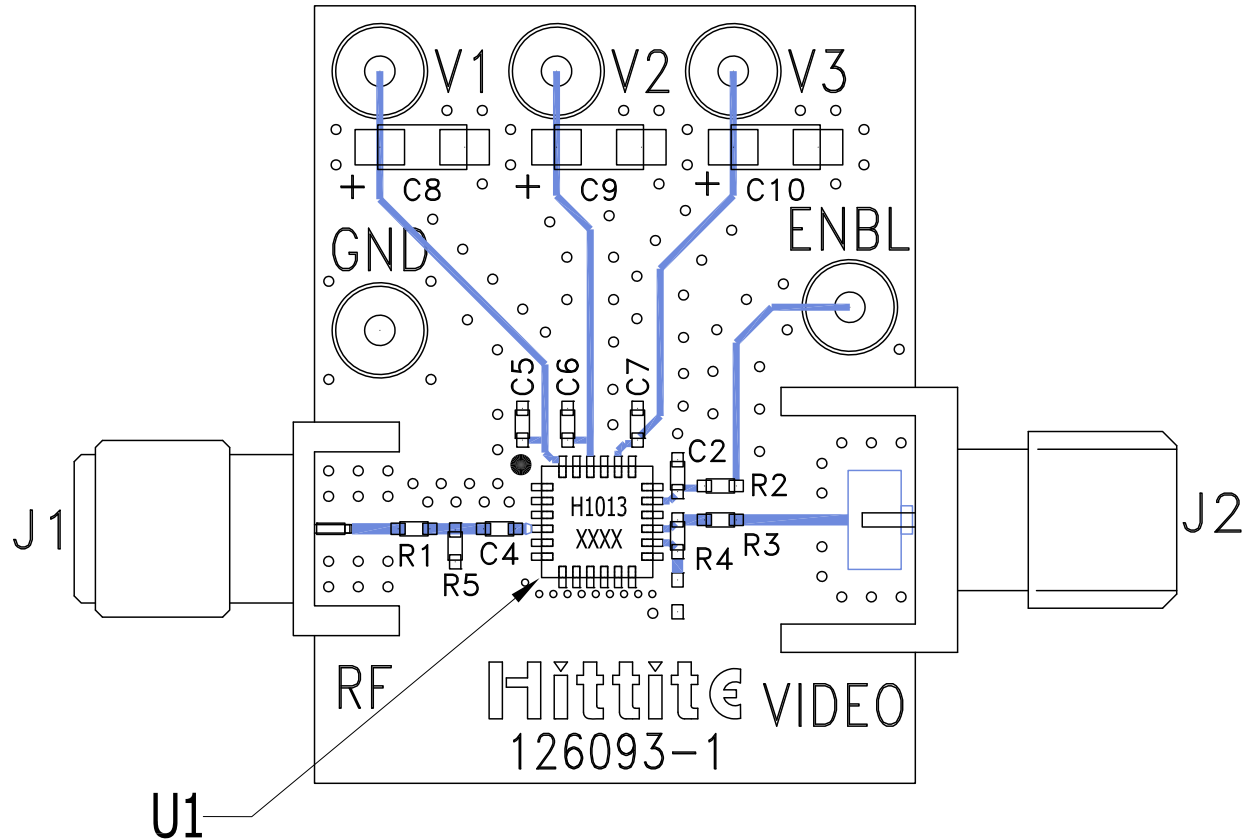

List of Materials for Evaluation PCB EVAL01-HMC1013LP4E^[1]

Item	Description
J1	K-Type Connector
J2	SMA Connector
J3 - J6	DC Pins
C2	47 pF Capacitor, 0402 Pkg.
C4	100 pF Capacitor, 0402 Pkg.
C5-C7	10 nF Capacitor, 0402 Pkg.
C8-C10	4.7 μF Capacitor, Tantalum.
R1-R4	0 Ohm Resistor, 0402 Pkg.
R5	120 Ohm Resistor, 0402 Pkg.
U1	HMC1013LP4E SDLVA
PCB ^[2]	126093 Evaluation PCB

[1] Reference this number when ordering complete evaluation PCB

[2] Circuit Board Material: Rogers 4350 or Arlon 25 FR

The circuit board used in the application should use RF circuit design techniques. Signal lines should have 50 ohm impedance while the package ground leads and exposed paddle should be connected directly to the ground plane similar to that shown. A sufficient number of via holes should be used to connect the top and bottom ground planes. N/C pins should also be connected to ground. The evaluation circuit board shown is available from Hittite upon request.



Компания «ЭлектроПласт» предлагает заключение долгосрочных отношений при поставках импортных электронных компонентов на взаимовыгодных условиях!

Наши преимущества:

- Оперативные поставки широкого спектра электронных компонентов отечественного и импортного производства напрямую от производителей и с крупнейших мировых складов;
- Поставка более 17-ти миллионов наименований электронных компонентов;
- Поставка сложных, дефицитных, либо снятых с производства позиций;
- Оперативные сроки поставки под заказ (от 5 рабочих дней);
- Экспресс доставка в любую точку России;
- Техническая поддержка проекта, помощь в подборе аналогов, поставка прототипов;
- Система менеджмента качества сертифицирована по Международному стандарту ISO 9001;
- Лицензия ФСБ на осуществление работ с использованием сведений, составляющих государственную тайну;
- Поставка специализированных компонентов (Xilinx, Altera, Analog Devices, Intersil, Interpoint, Microsemi, Aeroflex, Peregrine, Syfer, Eurofarad, Texas Instrument, Miteq, Cobham, E2V, MA-COM, Hittite, Mini-Circuits, General Dynamics и др.);

Помимо этого, одним из направлений компании «ЭлектроПласт» является направление «Источники питания». Мы предлагаем Вам помощь Конструкторского отдела:

- Подбор оптимального решения, техническое обоснование при выборе компонента;
- Подбор аналогов;
- Консультации по применению компонента;
- Поставка образцов и прототипов;
- Техническая поддержка проекта;
- Защита от снятия компонента с производства.



Как с нами связаться

Телефон: 8 (812) 309 58 32 (многоканальный)

Факс: 8 (812) 320-02-42

Электронная почта: org@eplast1.ru

Адрес: 198099, г. Санкт-Петербург, ул. Калинина, дом 2, корпус 4, литера А.