



Parameter	Rating	Units
Load Voltage	400	$V_P$
Load Current	250	$mA_{rms} / mA_{DC}$
On-Resistance (max)	8	$\Omega$

### Features

- 5000V<sub>rms</sub> Input/Output Isolation
- Low Drive Power Requirements (TTL/CMOS Compatible)
- No Moving Parts
- High Reliability
- Arc-Free With No Snubbing Circuits
- No EMI/RFI Generation
- Small 8-Pin Packages
- Machine Insertable, Wave Solderable
- Surface Mount Tape & Reel Version Available

### Applications

- Telecommunications
  - Telecom Switching
  - Tip/Ring Circuits
  - Modem Switching (Laptop, Notebook, Pocket Size)
  - Hook Switch
  - Dial Pulsing
  - Ground Start
  - Ringing Injection
- Instrumentation
  - Multiplexers
  - Data Acquisition
  - Electronic Switching
  - I/O Subsystems
- Meters (Watt-Hour, Water, Gas)
- Medical Equipment-Patient/Equipment Isolation
- Security
- Aerospace
- Industrial Controls

### Description

PAA191 is a dual 400V, 250mA, 8 $\Omega$ , normally open (1-Form-A) solid state relay that uses optically coupled MOSFET technology to provide 5000V<sub>rms</sub> of input to output isolation.

Its optically coupled outputs, which use the patented OptoMOS architecture, are controlled by a highly efficient GaAIAs infrared LED.

This dual single-pole OptoMOS relay provides a more compact design solution than discrete single-pole relays in a variety of applications, and saves board space by incorporating both switches in a single 8-pin package.

### Approvals

- UL Recognized Component: File E76270
- CSA Certified Component: Certificate 1175739
- EN/IEC 60950-1 Certified Component: TUV Certificate B 09 07 49410 004

### Ordering Information

Part #	Description
PAA191	8-Lead DIP (50/tube)
PAA191S	8-Lead Surface Mount (50/tube)
PAA191STR	8-Lead Surface Mount (1000/Reel)

### Pin Configuration

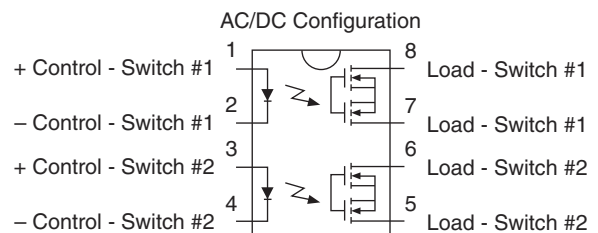

### Switching Characteristics of Normally Open Devices

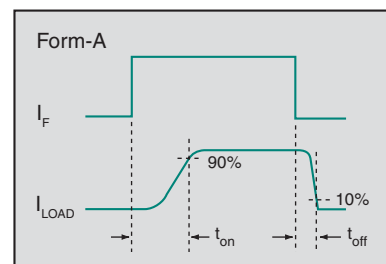

### Absolute Maximum Ratings @ 25°C

Parameter	Ratings	Units
Blocking Voltage	400	V <sub>P</sub>
Reverse Input Voltage	5	V
Input Control Current	50	mA
Peak (10ms)	1	A
Input Power Dissipation <sup>1</sup>	150	mW
Total Power Dissipation <sup>2</sup>	800	mW
Isolation Voltage, Input to Output	5000	V <sub>rms</sub>
Operational Temperature	-40 to +85	°C
Storage Temperature	-40 to +125	°C

<sup>1</sup> Derate linearly 1.33 mW / °C

<sup>2</sup> Derate linearly 6.67 mW / °C

Absolute Maximum Ratings are stress ratings. Stresses in excess of these ratings can cause permanent damage to the device. Functional operation of the device at conditions beyond those indicated in the operational sections of this data sheet is not implied.

### Electrical Characteristics @ 25°C

Parameter	Conditions	Symbol	Min	Typ	Max	Units
<b>Output Characteristics</b>						
Load Current *						
Continuous, AC/DC Configuration	-	I <sub>L</sub>	-	-	250	mA <sub>rms</sub> / mA <sub>DC</sub>
Peak	10ms	I <sub>LPK</sub>	-	-	±500	mA <sub>P</sub>
On-Resistance, AC/DC Configuration	I <sub>L</sub> =250mA	R <sub>ON</sub>	-	6	8	Ω
Off-State Leakage Current	V <sub>L</sub> =400V <sub>P</sub>	I <sub>LEAK</sub>	-	-	1	μA
Switching Speeds						
Turn-On	I <sub>F</sub> =5mA, V <sub>L</sub> =10V	t <sub>on</sub>	-	-	3	ms
Turn-Off		t <sub>off</sub>	-	-	1	
Output Capacitance	V <sub>L</sub> =50V, f=1MHz	C <sub>OUT</sub>	-	25	-	pF
<b>Input Characteristics</b>						
Input Control Current to Activate	I <sub>L</sub> =250mA	I <sub>F</sub>	-	-	5	mA
Input Control Current to Deactivate	-	I <sub>F</sub>	0.2	0.7	-	mA
Input Voltage Drop	I <sub>F</sub> =5mA	V <sub>F</sub>	0.9	1.2	1.4	V
Reverse Input Current	V <sub>R</sub> =5V	I <sub>R</sub>	-	-	10	μA
<b>Common Characteristics</b>						
Capacitance, Input to Output	-	C <sub>I/O</sub>	-	3	-	pF

\*NOTE: If both poles operate simultaneously, then load current must be derated in order not to exceed the package power dissipation value.

**PERFORMANCE DATA @25°C (Unless Otherwise Noted)\***

**Typical LED Forward Voltage Drop**  
(N=50, I<sub>F</sub>=5mA)

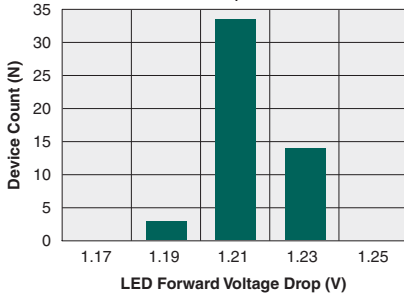

**Typical Turn-On Time**  
(N=50, I<sub>F</sub>=5mA, I<sub>L</sub>=250mA<sub>DC</sub>)

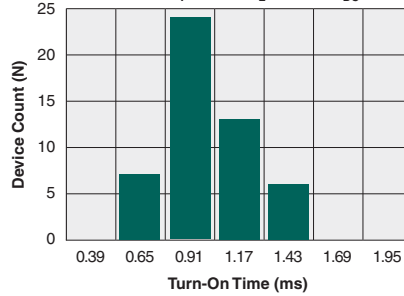

**Typical Turn-Off Time**  
(N=50, I<sub>F</sub>=5mA, I<sub>L</sub>=250mA<sub>DC</sub>)

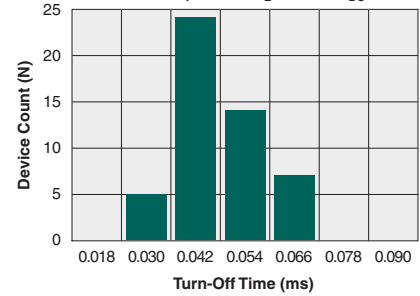

**Typical I<sub>F</sub> for Switch Operation**  
(N=50, I<sub>L</sub>=250mA<sub>DC</sub>)

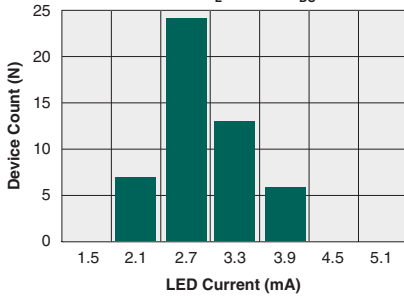

**Typical I<sub>F</sub> for Switch Dropout**  
(N=50, I<sub>L</sub>=250mA<sub>DC</sub>)

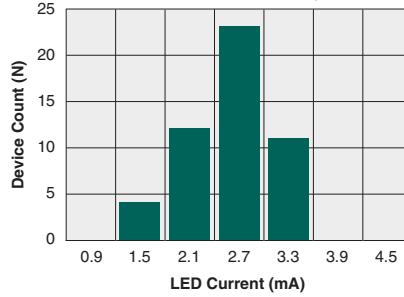

**Typical On-Resistance Distribution**  
(N=50, I<sub>F</sub>=5mA, I<sub>L</sub>=250mA<sub>DC</sub>)

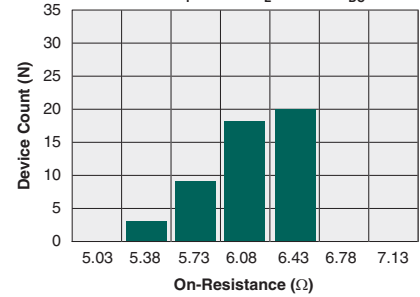

**Typical Blocking Voltage Distribution**  
(N=50)

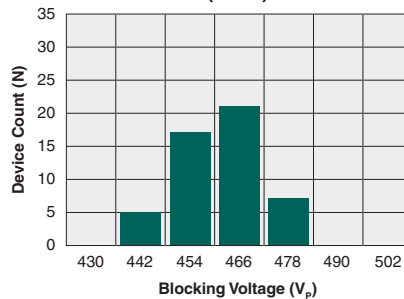

**Typical LED Forward Voltage Drop vs. Temperature**

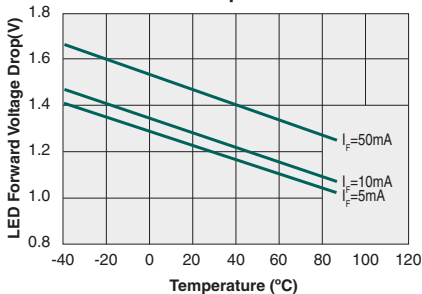

**Typical Turn-On Time vs. LED Forward Current**  
(I<sub>L</sub>=250mA<sub>DC</sub>)

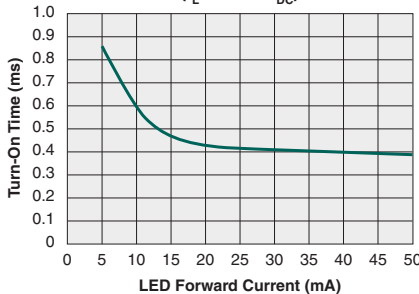

**Typical Turn-Off Time vs. LED Forward Current**  
(I<sub>L</sub>=250mA<sub>DC</sub>)

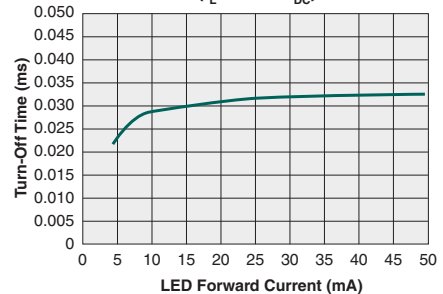

\*The Performance data shown in the graphs above is typical of device performance. For guaranteed parameters not indicated in the written specifications, please contact our application department.

**PERFORMANCE DATA @25°C (Unless Otherwise Noted)\***

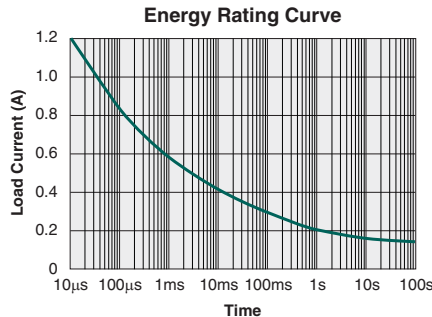
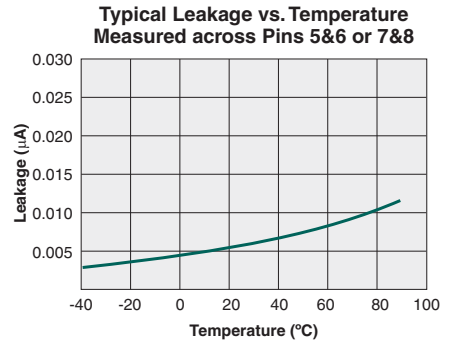
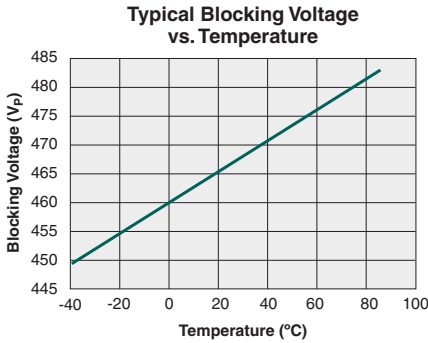
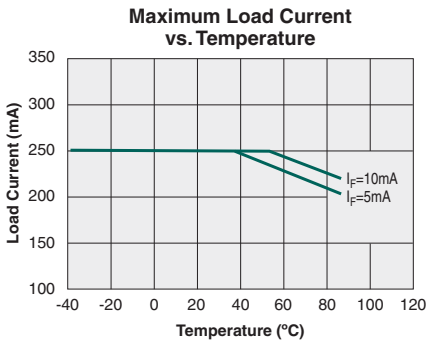
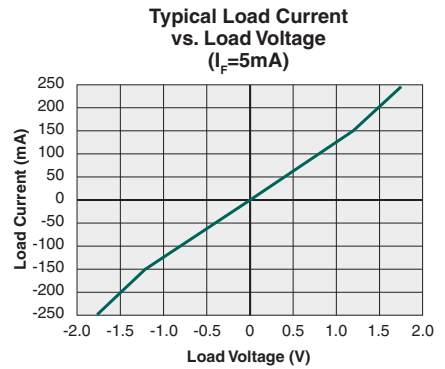
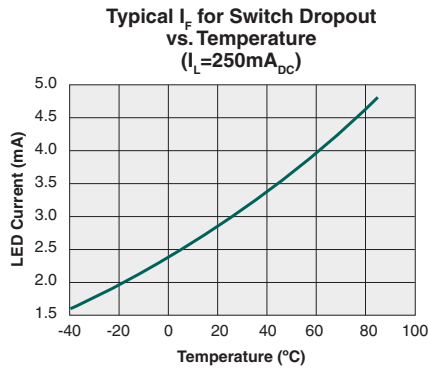
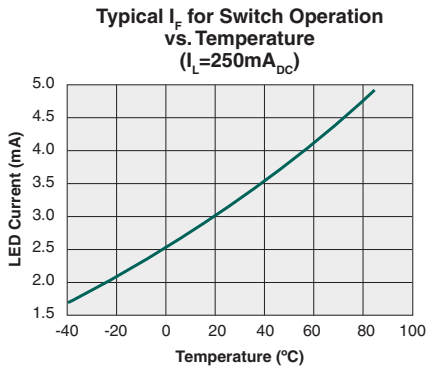
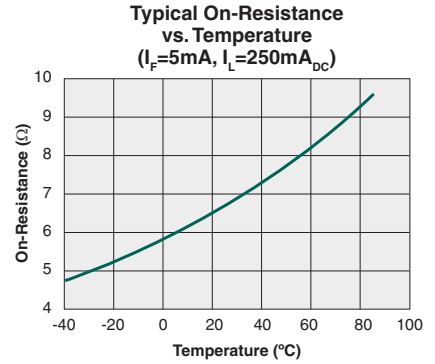
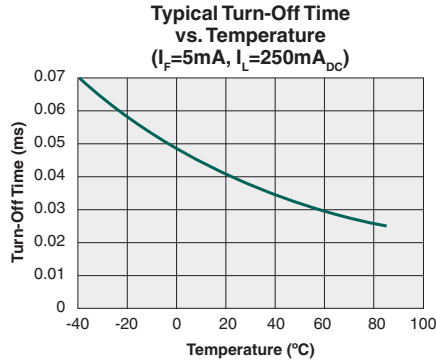
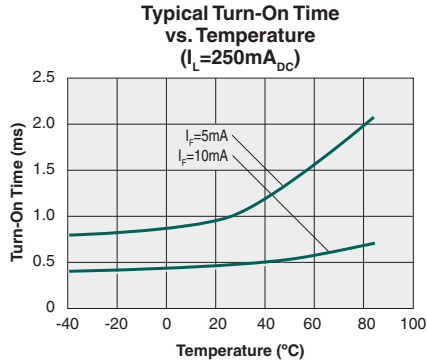

\*The Performance data shown in the graphs above is typical of device performance. For guaranteed parameters not indicated in the written specifications, please contact our application department.

## Manufacturing Information

### Moisture Sensitivity



All plastic encapsulated semiconductor packages are susceptible to moisture ingress. IXYS Integrated Circuits Division classified all of its plastic encapsulated devices for moisture sensitivity according to the latest version of the joint industry standard, **IPC/JEDEC J-STD-020**, in force at the time of product evaluation. We test all of our products to the maximum conditions set forth in the standard, and guarantee proper operation of our devices when handled according to the limitations and information in that standard as well as to any limitations set forth in the information or standards referenced below.

Failure to adhere to the warnings or limitations as established by the listed specifications could result in reduced product performance, reduction of operable life, and/or reduction of overall reliability.

This product carries a **Moisture Sensitivity Level (MSL) rating** as shown below, and should be handled according to the requirements of the latest version of the joint industry standard **IPC/JEDEC J-STD-033**.

Device	Moisture Sensitivity Level (MSL) Rating
PAA191 / PAA191S	MSL 1

### ESD Sensitivity



This product is **ESD Sensitive**, and should be handled according to the industry standard **JESD-625**.

### Reflow Profile

This product has a maximum body temperature and time rating as shown below. All other guidelines of **J-STD-020** must be observed.

Device	Maximum Temperature x Time
PAA191 / PAA191S	250°C for 30 seconds

### Board Wash

IXYS Integrated Circuits Division recommends the use of no-clean flux formulations. However, board washing to remove flux residue is acceptable. Since IXYS Integrated Circuits Division employs the use of silicone coating as an optical waveguide in many of its optically isolated products, the use of a short drying bake could be necessary if a wash is used after solder reflow processes. Chlorine- or Fluorine-based solvents or fluxes should not be used. Cleaning methods that employ ultrasonic energy should not be used.



### Mechanical Dimensions

#### PAA191

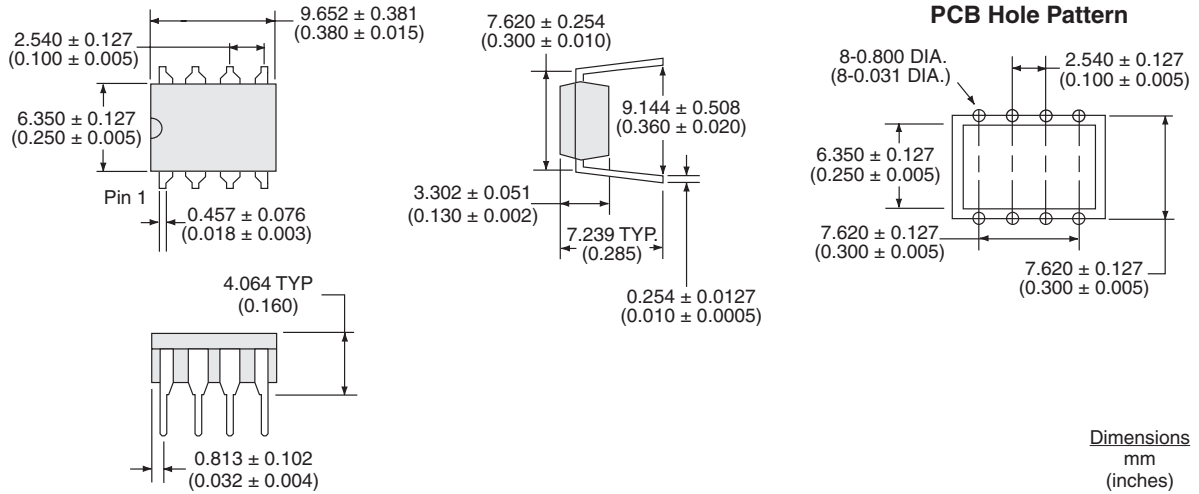

#### PAA191S

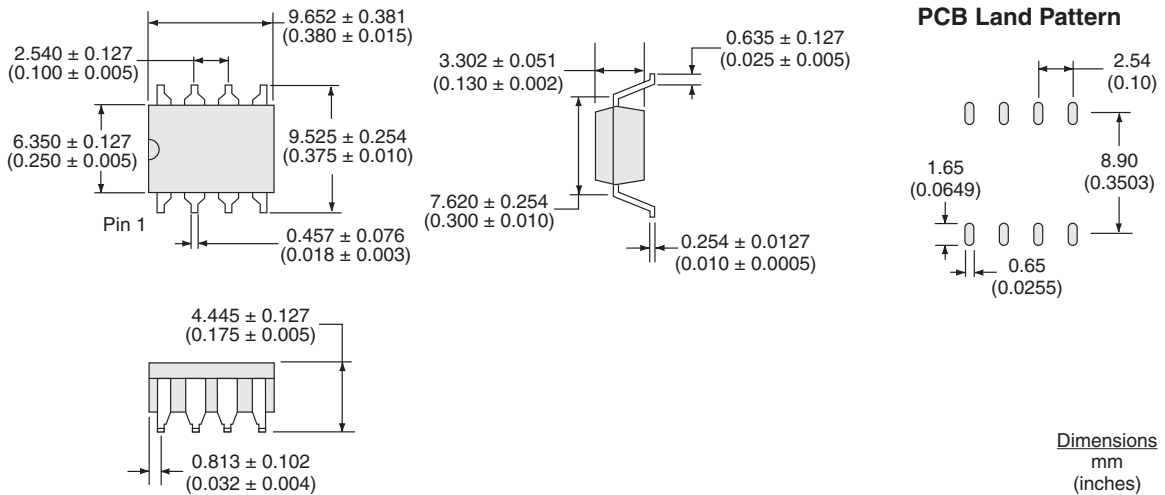

**PAA191STR Tape & Reel**

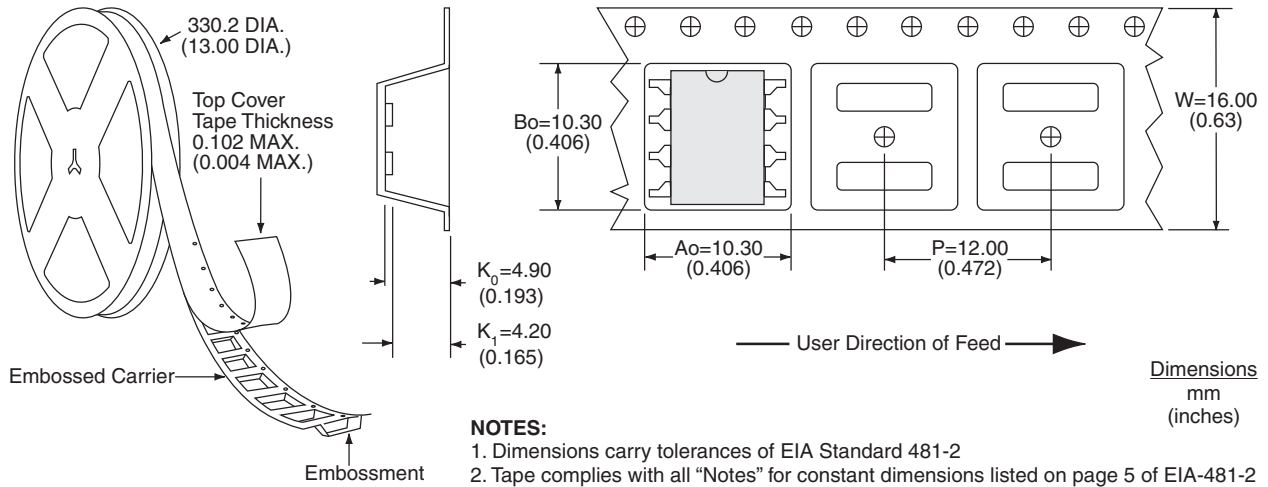

For additional information please visit our website at: [www.ixysic.com](http://www.ixysic.com)

IXYS Integrated Circuits Division makes no representations or warranties with respect to the accuracy or completeness of the contents of this publication and reserves the right to make changes to specifications and product descriptions at any time without notice. Neither circuit patent licenses nor indemnity are expressed or implied. Except as set forth in IXYS Integrated Circuits Division's Standard Terms and Conditions of Sale, IXYS Integrated Circuits Division assumes no liability whatsoever, and disclaims any express or implied warranty, relating to its products including, but not limited to, the implied warranty of merchantability, fitness for a particular purpose, or infringement of any intellectual property right.

The products described in this document are not designed, intended, authorized or warranted for use as components in systems intended for surgical implant into the body, or in other applications intended to support or sustain life, or where malfunction of IXYS Integrated Circuits Division's product may result in direct physical harm, injury, or death to a person or severe property or environmental damage. IXYS Integrated Circuits Division reserves the right to discontinue or make changes to its products at any time without notice.



Компания «ЭлектроПласт» предлагает заключение долгосрочных отношений при поставках импортных электронных компонентов на взаимовыгодных условиях!

Наши преимущества:

- Оперативные поставки широкого спектра электронных компонентов отечественного и импортного производства напрямую от производителей и с крупнейших мировых складов;
- Поставка более 17-ти миллионов наименований электронных компонентов;
- Поставка сложных, дефицитных, либо снятых с производства позиций;
- Оперативные сроки поставки под заказ (от 5 рабочих дней);
- Экспресс доставка в любую точку России;
- Техническая поддержка проекта, помощь в подборе аналогов, поставка прототипов;
- Система менеджмента качества сертифицирована по Международному стандарту ISO 9001;
- Лицензия ФСБ на осуществление работ с использованием сведений, составляющих государственную тайну;
- Поставка специализированных компонентов (Xilinx, Altera, Analog Devices, Intersil, Interpoint, Microsemi, Aeroflex, Peregrine, Syfer, Eurofarad, Texas Instrument, Miteq, Cobham, E2V, MA-COM, Hittite, Mini-Circuits, General Dynamics и др.);

Помимо этого, одним из направлений компании «ЭлектроПласт» является направление «Источники питания». Мы предлагаем Вам помощь Конструкторского отдела:

- Подбор оптимального решения, техническое обоснование при выборе компонента;
- Подбор аналогов;
- Консультации по применению компонента;
- Поставка образцов и прототипов;
- Техническая поддержка проекта;
- Защита от снятия компонента с производства.



#### Как с нами связаться

**Телефон:** 8 (812) 309 58 32 (многоканальный)

**Факс:** 8 (812) 320-02-42

**Электронная почта:** [org@eplast1.ru](mailto:org@eplast1.ru)

**Адрес:** 198099, г. Санкт-Петербург, ул. Калинина, дом 2, корпус 4, литера А.