

Full-Swing Input and Output type Dual Operational Amplifier

■ GENERAL DESCRIPTION

NJM2732 is dual operational amplifier with full swing input and output, operate from 1.8V. Input and Output Full Swing provides wide dynamic range, is from ground to power supply level. In addition to ground sensing applications, NJM2732 enable to be applied to Hi-side sensing applications.

The features are low noise and low operating voltage for battery management, portable audio applications, and others.

■ FEATURES

- Operating Voltage : 1.8 to 6.0V
- Input Full-Swing : $V_{ICM} = 0$ to 5.0V, at $V^+ = 5V$
- Output Full-Swing : $V_{OH} \geq 4.9V$ / $V_{OL} \leq 0.1V$, at $V^+ = 5V$, $R_L = 20k\Omega$
- Load Drivability : $V_{OH} \geq 4.75V$ / $V_{OL} \leq 0.25V$, at $V^+ = 5V$, $R_L = 2k\Omega$
- Offset Voltage : 5mV max.
- Slew Rate : 0.4V/ μ s typ.
- Low Input Voltage Noise : 10nV/ \sqrt{Hz} typ.
- Adequate phase margin : $\Phi_M = 75$ deg. typ., at $R_L = 2k\Omega$, voltage follower
- Bipolar Technology
- Package Outline : DIP8, DMP8, EMP8, SSOP8, TVSP8

■ PACKAGE OUTLINE



NJM2732D



NJM2732M



NJM2732E



NJM2732V



NJM2732RB1

■ PIN CONFIGURATION

(Top View)

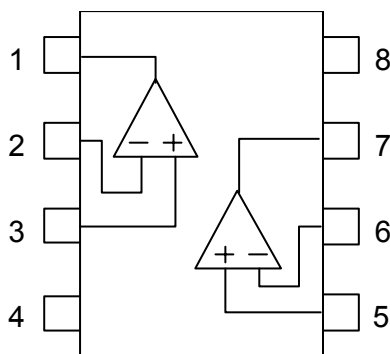

PIN FUNCTION

- 1. A OUTPUT
- 2. A -INPUT
- 3. A +INPUT
- 4. GND
- 5. B +INPUT
- 6. B -INPUT
- 7. B OUTPUT
- 8. V⁺

- NJM2732D
- NJM2732M
- NJM2732E
- NJM2732V
- NJM2732RB1

NJM2732

■ ABSOLUTE MAXIMUM RATINGS

(Ta=25°C)

PARAMETER	SYMBOL	RATINGS	UNIT
Supply Voltage	V^+	7.0	V
Differential Input Voltage Range	V_{ID}	± 1.0	V
Common Mode Input Voltage Range	V_{IC}	0 ~ 7.0 (Note1)	V
Power Dissipation	P_D	(DIP8) 500 (DMP8) 300 (EMP8) 320 (SSOP8) 250 (TVSP8) 320	mW
Operating Temperature Range	T_{opr}	-40~+85	°C
Storage Temperature Range	T_{stg}	-40~+125	°C

(Note1) For supply voltage less than 7V, the absolute maximum input voltage is equal to the supply voltage.

■ RECOMMENDED OPERATING CONDITION

(Ta=25°C)

PARAMETER	SYMBOL	RATING	UNIT
Supply Voltage	V^+	1.8 to 6.0	V

■ ELECTRICAL CHARACTERISTICS ($V^+=5V$, Ta=25°C)

●DC CHARACTERISTICS

($V^+=5V$, Ta=25°C)

PARAMETER	SYMBOL	TEST CONDITION	MIN.	TYP.	MAX.	UNIT
Operating Current	I_{CC}	No signal applied	-	580	900	μA
Input Offset Voltage	V_{IO}		-	1	5	mV
Input Bias Current	I_B		-	50	250	nA
Input Offset Current	I_{IO}		-	5	100	nA
Large Signal Voltage Gain	A_V	$R_L=2k\Omega$	60	85	-	dB
Common Mode Rejection Ratio	CMR	CMR+: $2.5V \leq V_{CM} \leq 5V$ CMR-: $0V \leq V_{CM} \leq 2.5V$ (Note2)	55	70	-	dB
Supply Voltage Rejection Ratio	SVR	$V^+/V = \pm 2.0V \sim \pm 3.0V$	70	85	-	dB
Maximum Output Voltage 1	V_{OH1}	$R_L=20k\Omega$	4.9	4.95	-	V
	V_{OL1}	$R_L=20k\Omega$	-	0.05	0.1	V
Maximum Output Voltage 2	V_{OH2}	$R_L=2k\Omega$	4.75	4.85	-	V
	V_{OL2}	$R_L=2k\Omega$	-	0.15	0.25	V
Input Common Mode Voltage Range	V_{ICM}	CMR ≥ 55 dB	0	-	5	V

(Note2) CMR is represented by either CMR+ or CMR- has lower value.

CMR+ is measured with $2.5V \leq V_{CM} \leq 5.0$ and CMR- is measured with $0V \leq V_{CM} \leq 2.5V$.

●AC CHARACTERISTICS

($V^+=5V$, Ta=25°C)

PARAMETER	SYMBOL	TEST CONDITION	MIN.	TYP.	MAX.	UNIT
Unity Gain Bandwidth	GB	$R_L=2k\Omega$	-	1	-	MHz
Phase Margin	Φ_M	$R_L=2k\Omega$	-	75	-	Deg
Equivalent Input Noise Voltage	V_{NI}	$f=1kHz$	-	10	-	nV/ \sqrt{Hz}

●TRANSIENT CHARACTERISTICS

($V^+=5V$, Ta=25°C)

PARAMETER	SYMBOL	TEST CONDITION	MIN.	TYP.	MAX.	UNIT
Slew Rate	SR	$R_L=2k\Omega$	-	0.4	-	V/ μs

■ ELECTRICAL CHARACTERISTICS ($V^+=3V, T_a=25^\circ C$)

●DC CHARACTERISTICS

($V^+=3V, T_a=25^\circ C$)

PARAMETER	SYMBOL	TEST CONDITION	MIN.	TYP.	MAX.	UNIT
Operating Current	I_{CC}	No signal applied	-	510	880	μA
Input Offset Voltage	V_{IO}		-	1	5	mV
Input Bias Current	I_B		-	50	250	nA
Input Offset Current	I_{IO}		-	5	100	nA
Large Signal Voltage Gain	A_V	$R_L=2k\Omega$	60	84	-	dB
Common Mode Rejection Ratio	CMR	CMR+: $1.5V \leq V_{CM} \leq 3V$ CMR-: $0V \leq V_{CM} \leq 1.5V$ (Note3)	48	63	-	dB
Supply Voltage Rejection Ratio	SVR	$V^+V^-=\pm 1.2V \sim \pm 2.0V$	68	83	-	dB
Maximum Output Voltage 1	V_{OH1}	$R_L=20k\Omega$	2.9	2.95	-	V
	V_{OL1}	$R_L=20k\Omega$	-	0.05	0.1	V
Maximum Output Voltage 2	V_{OH2}	$R_L=2k\Omega$	2.75	2.85	-	V
	V_{OL2}	$R_L=2k\Omega$	-	0.15	0.25	V
Input Common Mode Voltage Range	V_{ICM}	CMR \geq 48dB	0	-	3	V

(Note3) CMR is represented by either CMR+ or CMR-has lower value.

CMR+ is measured with $1.5V \leq V_{CM} \leq 3.0$ and CMR- is measured with $0V \leq V_{CM} \leq 1.5V$.

●AC CHARACTERISTICS

($V^+=3V, T_a=25^\circ C$)

PARAMETER	SYMBOL	TEST CONDITION	MIN.	TYP.	MAX.	UNIT
Unity Gain Bandwidth	GB	$R_L=2k\Omega$	-	1	-	MHz
Phase Margin	Φ_M	$R_L=2k\Omega$	-	75	-	Deg
Equivalent Input Noise Voltage	V_{NI}	$f=1kHz$	-	10	-	nV/\sqrt{Hz}

●TRANSIENT CHARACTERISTICS

($V^+=3V, T_a=25^\circ C$)

PARAMETER	SYMBOL	TEST CONDITION	MIN.	TYP.	MAX.	UNIT
Slew Rate	SR	$R_L=2k\Omega$	-	0.35	-	V/ μs

■ ELECTRICAL CHARACTERISTICS ($V^+=1.8V, T_a=25^\circ C$)

●DC CHARACTERISTICS

($V^+=1.8V, T_a=25^\circ C$)

PARAMETER	SYMBOL	TEST CONDITION	MIN.	TYP.	MAX.	UNIT
Operating Current	I_{CC}	No signal applied	-	460	800	μA
Input Offset Voltage	V_{IO}		-	1	5	mV
Input Bias Current	I_B		-	50	250	nA
Input Offset Current	I_{IO}		-	5	100	nA
Large Signal Voltage Gain	A_V	$R_L=2k\Omega$	60	83	-	dB
Common Mode Rejection Ratio	CMR	CMR+: $0.9V \leq V_{CM} \leq 1.8V$ CMR-: $0V \leq V_{CM} \leq 0.9V$ (Note4)	48	55	-	dB
Supply Voltage Rejection Ratio	SVR	$V^+V^-=\pm 1.2V \sim \pm 2.0V$	65	80	-	dB
Maximum Output Voltage 1	V_{OH1}	$R_L=20k\Omega$	1.7	1.75	-	V
	V_{OL1}	$R_L=20k\Omega$	-	0.05	0.1	V
Maximum Output Voltage 2	V_{OH2}	$R_L=2k\Omega$	1.55	1.65	-	V
	V_{OL2}	$R_L=2k\Omega$	-	0.15	0.25	V
Input Common Mode Voltage Range	V_{ICM}	CMR \geq 40dB	0	-	1.8	V

(Note4) CMR is represented by either CMR+ or CMR-has lower value.

CMR+ is measured with $0.9V \leq V_{CM} \leq 1.8$ and CMR- is measured with $0V \leq V_{CM} \leq 0.9V$.

●AC CHARACTERISTICS

($V^+=1.8V, T_a=25^\circ C$)

PARAMETER	SYMBOL	TEST CONDITION	MIN.	TYP.	MAX.	UNIT
Unity Gain Bandwidth	GB	$R_L=2k\Omega$	-	1	-	MHz
Phase Margin	Φ_M	$R_L=2k\Omega$	-	75	-	Deg
Equivalent Input Noise Voltage	V_{NI}	$f=1kHz$	-	10	-	nV/\sqrt{Hz}

●TRANSIENT CHARACTERISTICS

($V^+=1.8V, T_a=25^\circ C$)

PARAMETER	SYMBOL	TEST CONDITION	MIN.	TYP.	MAX.	UNIT
Slew Rate	SR	$R_L=2k\Omega$	-	0.3	-	V/ μs

■ TYPICAL CHARACTERISTICS

Operating Current vs Operating Voltage

$G_V=0\text{dB}$, $T_a=25^\circ\text{C}$

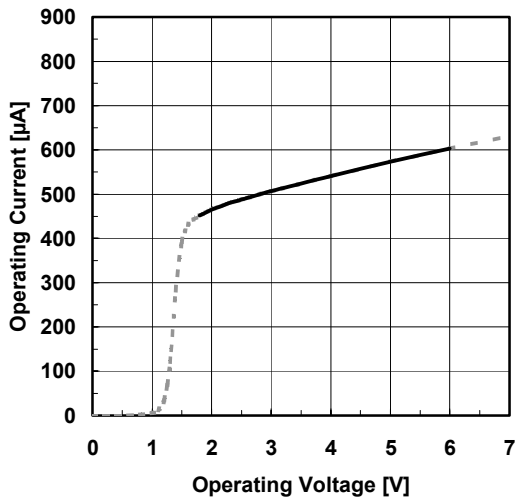

Operating Current vs. Operating Voltage (correlation with T_a)

$G_V=0\text{dB}$, $T_a=25^\circ\text{C}$

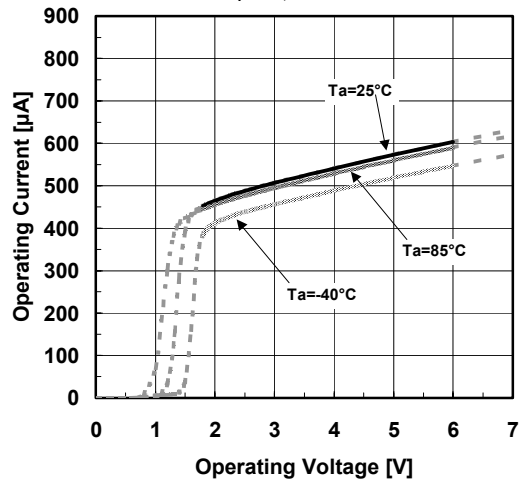

Operating Current vs. Ambient Temperature

$G_V=0\text{dB}$

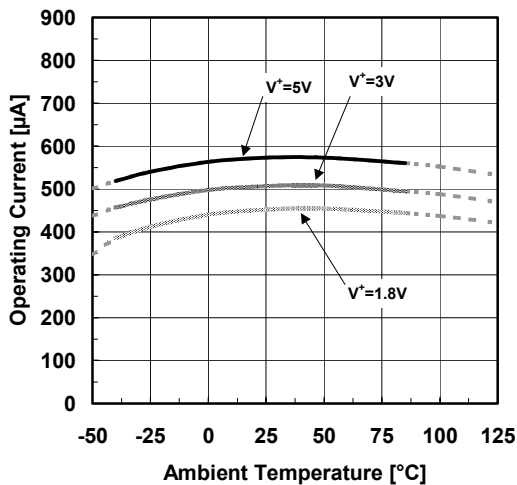

Input Offset Voltage vs. Ambient Temperature

$G_V=0\text{dB}$

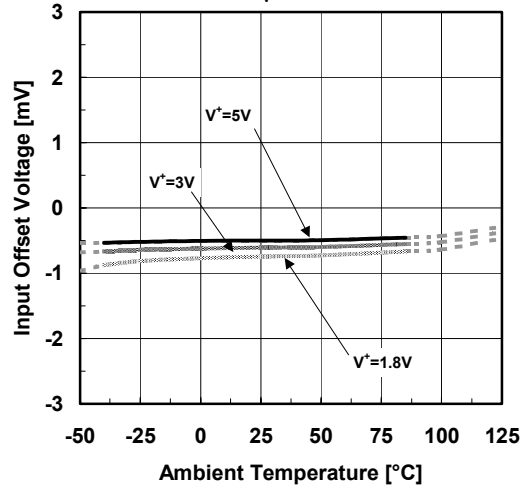

Input Bias Current vs. Ambient Temperature

$G_V=0\text{dB}$

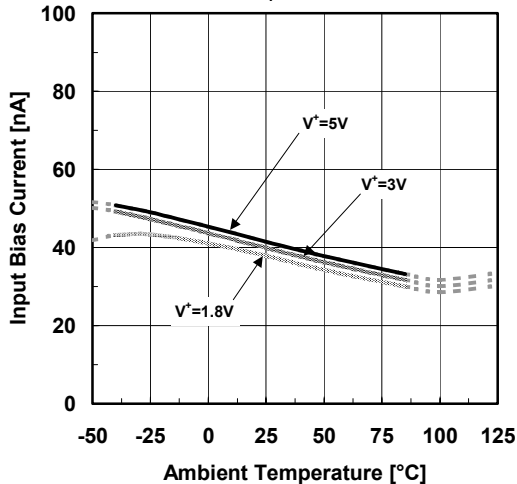

Input Offset Current vs. Ambient Temperature

$G_V=0\text{dB}$

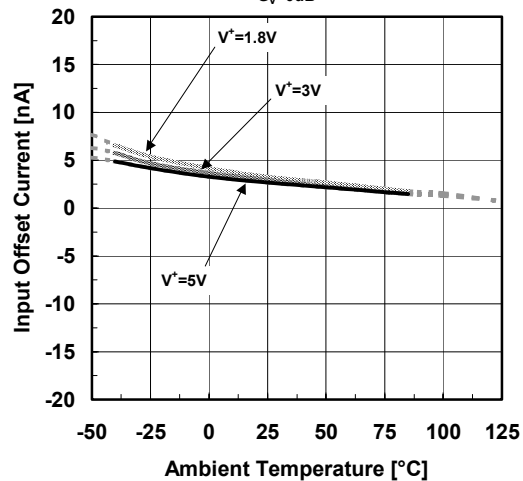

■ TYPICAL CHARACTERISTICS

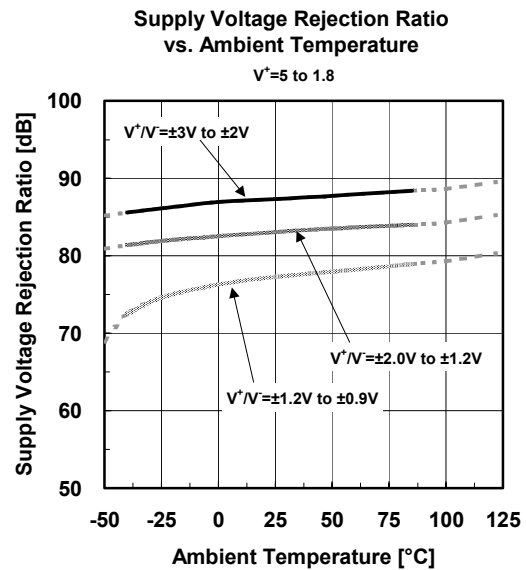
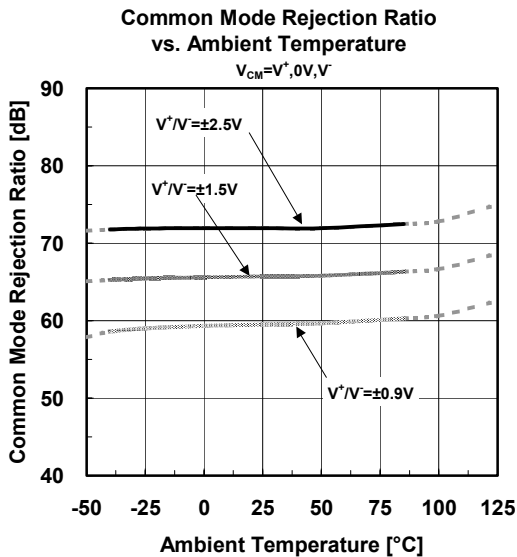
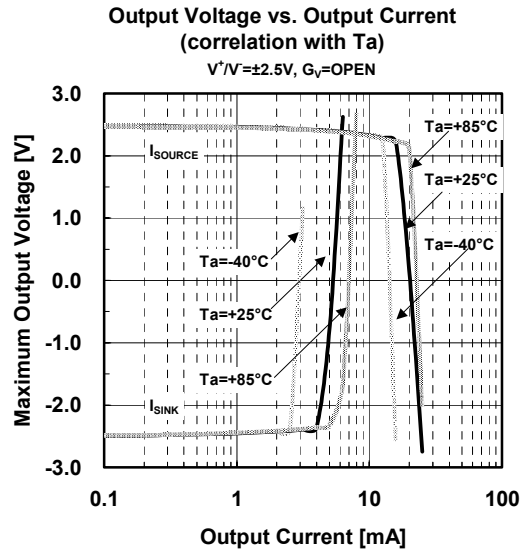
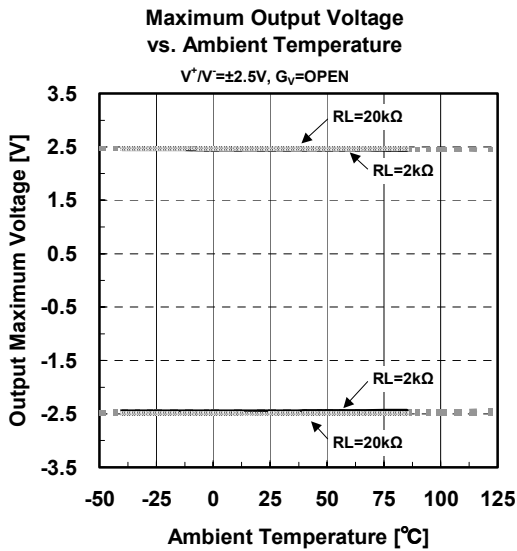
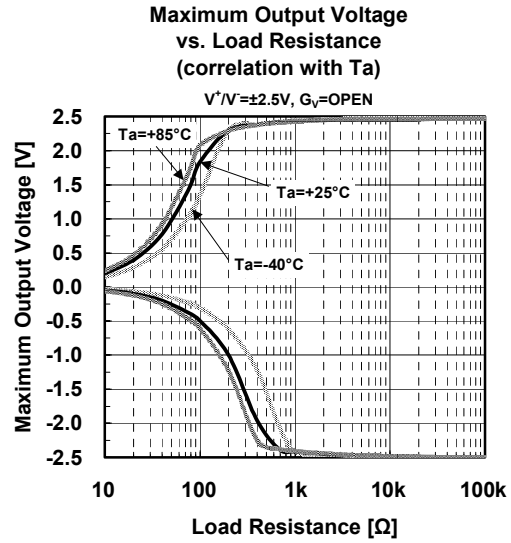
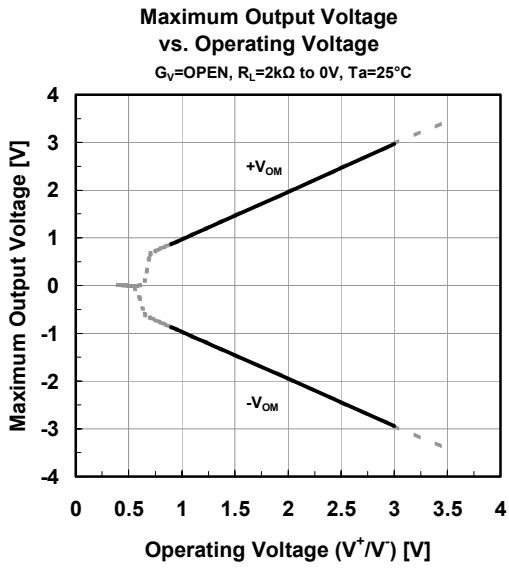

■ TYPICAL CHARACTERISTICS

**Voltage Gain/Phase vs. Frequency
(with Capacitive load)**

$V^+ / V^- = \pm 2.5V$, $G_V = 40dB$, $R_F = 2k\Omega$,
 $R_G = 20\Omega$, $R_L = 2k\Omega$, $T_a = +25^\circ C$

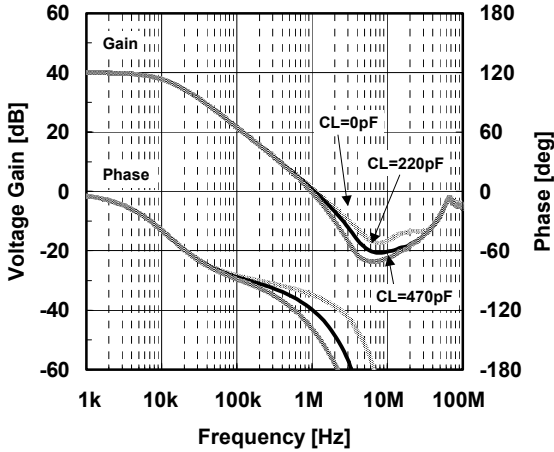

**Voltage Gain/Phase vs. Frequency
(correlation with T_a)**

$V^+ / V^- = \pm 2.5V$, $G_V = 40dB$,
 $R_F = 2k\Omega$, $R_G = 20\Omega$, $R_L = 2k\Omega$, $C_L = 0pF$

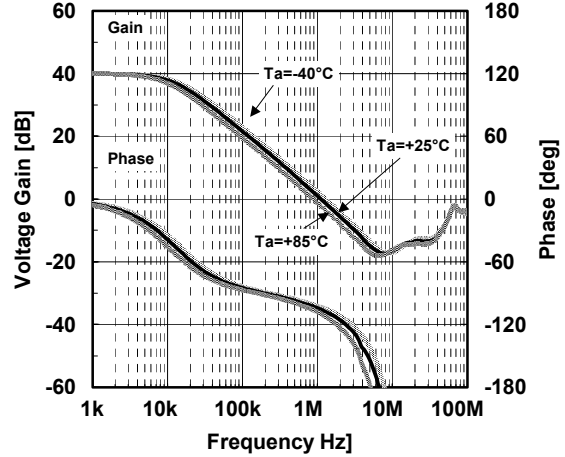

**Phase Margin vs. Load Capacitance
(with Capacitance Load)**

$V^+ / V^- = \pm 1.5V$, $G_V = 40dB$, $R_F = 2k\Omega$,
 $R_G = 20\Omega$, $R_L = 2k\Omega$, $T_a = +25^\circ C$

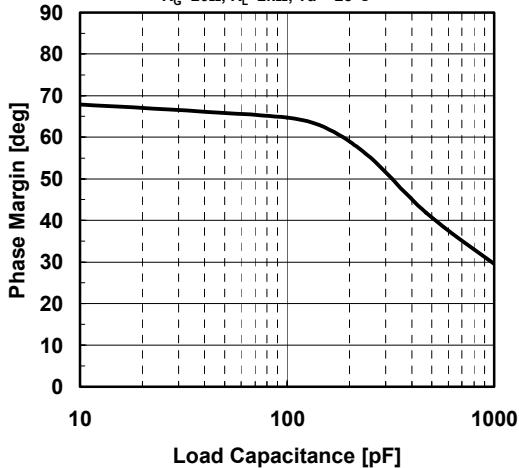

**Voltage Gain vs. Frequency
(correlation with T_a)**

$V^+ / V^- = \pm 2.5V$, $G_V = 0dB$, $C_L = 100pF$,
 $R_S = 50\Omega$, $R_L = 2k\Omega$

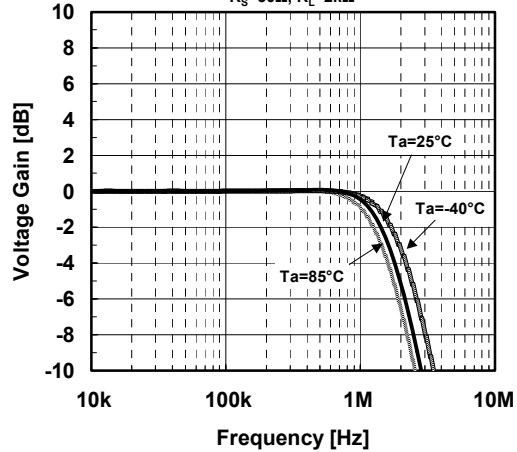

**Voltage Gain vs. Frequency
(with Capacitance Load)**

$V^+ / V^- = \pm 2.5V$, $G_V = 0dB$,
 $R_S = 50\Omega$, $R_L = 2k\Omega$, $T_a = +25^\circ C$

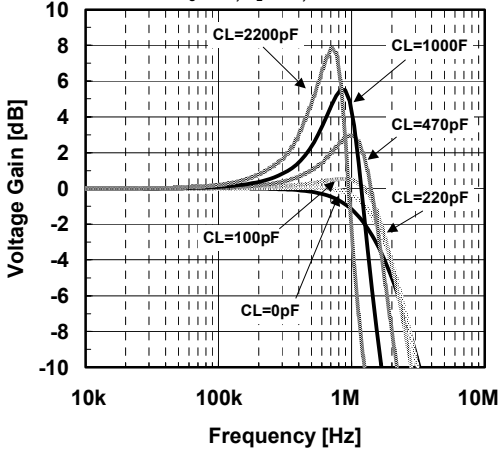

**Voltage Gain vs. Frequency
(correlation with T_a)**

$V^+ / V^- = \pm 2.5V$, $G_V = 0dB$, $C_L = 1000pF$,
 $R_S = 50\Omega$, $R_L = 2k\Omega$

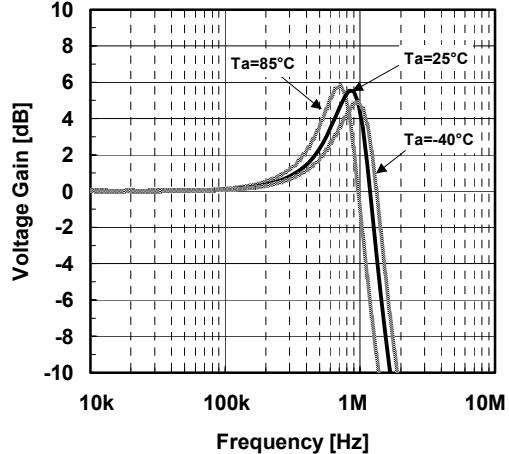

■ TYPICAL CHARACTERISTICS

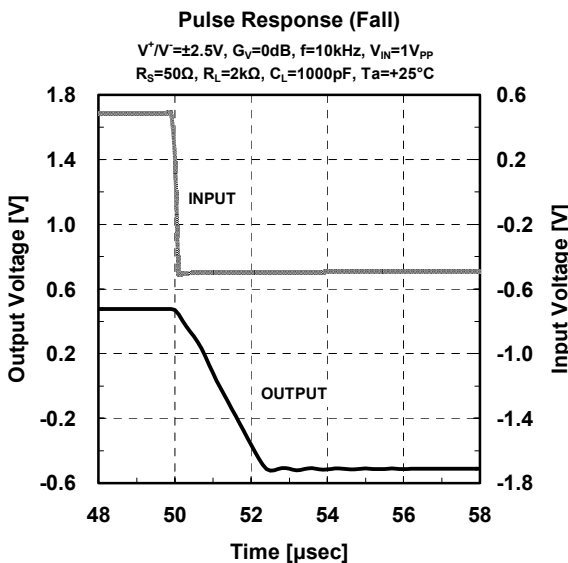
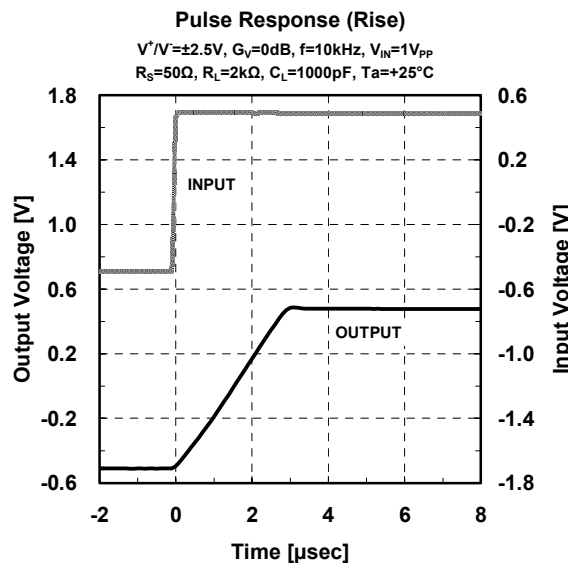
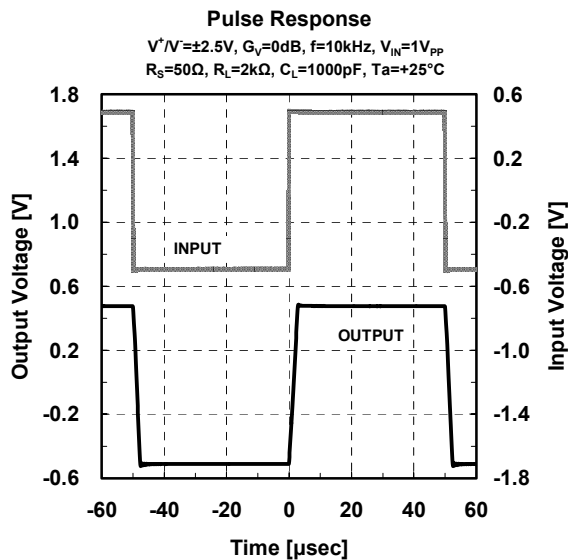
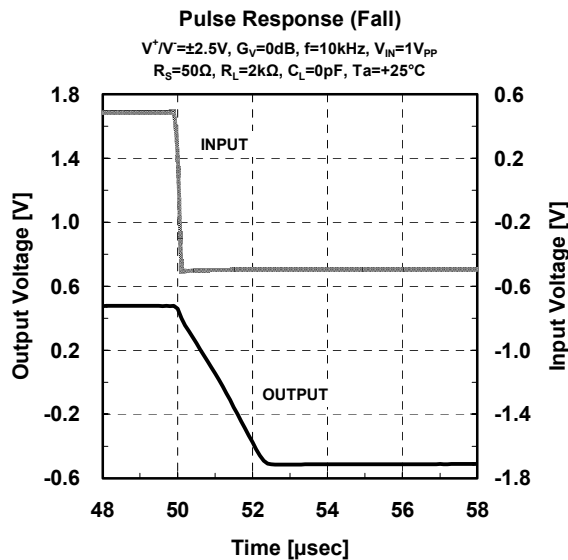
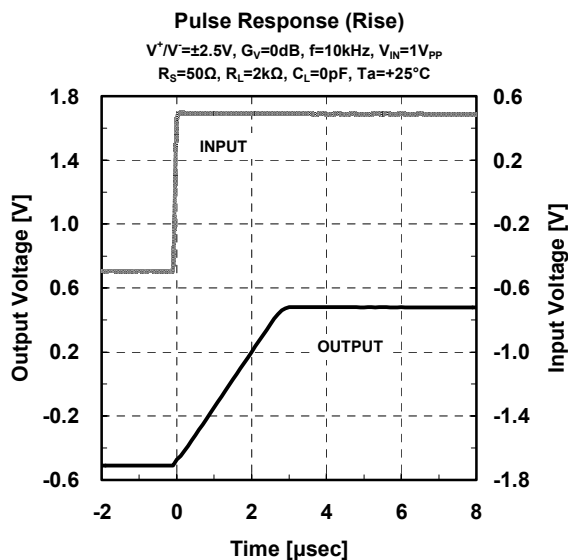
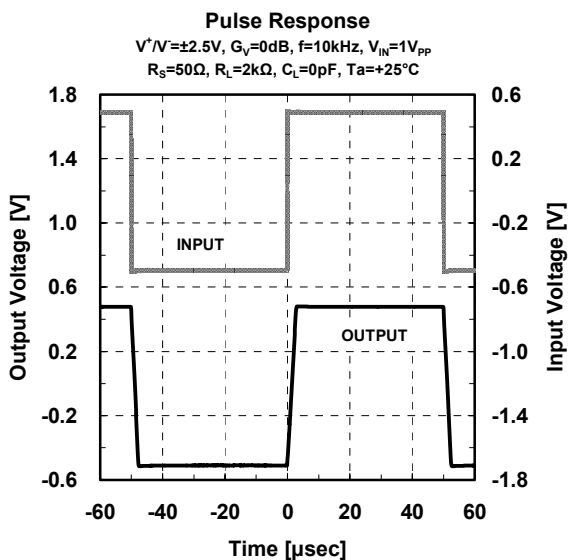

■ TYPICAL CHARACTERISTICS

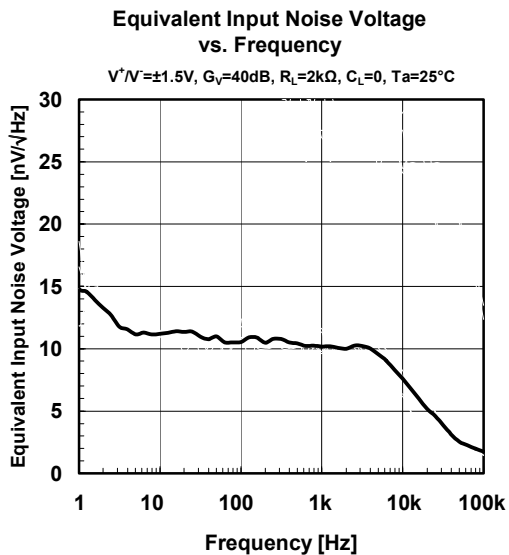
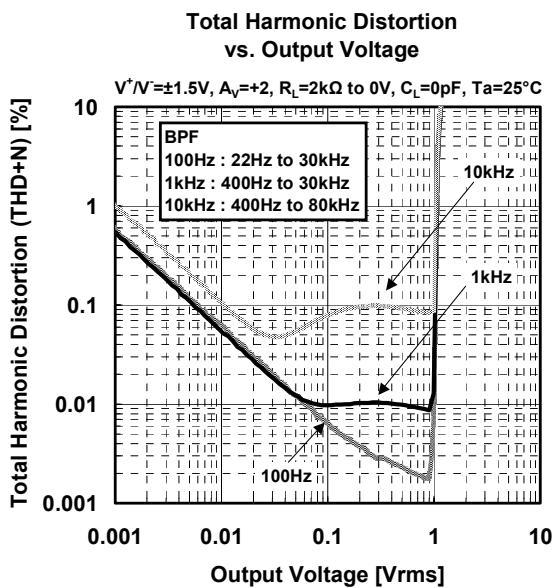
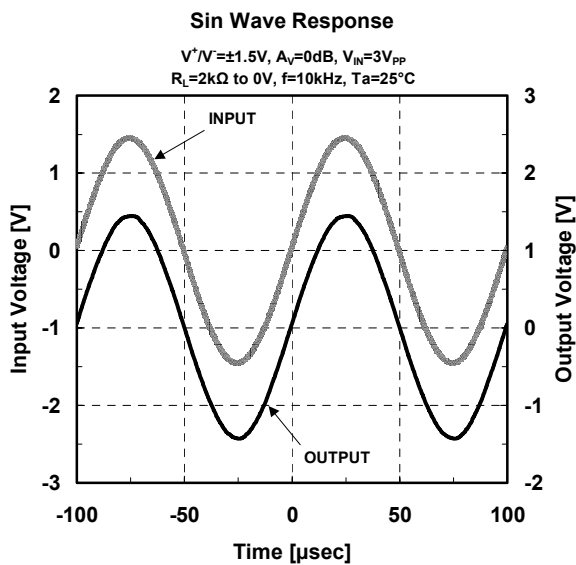

[CAUTION]

The specifications on this databook are only given for information, without any guarantee as regards either mistakes or omissions. The application circuits in this databook are described only to show representative usages of the product and not intended for the guarantee or permission of any right including the industrial rights.



Компания «ЭлектроПласт» предлагает заключение долгосрочных отношений при поставках импортных электронных компонентов на взаимовыгодных условиях!

Наши преимущества:

- Оперативные поставки широкого спектра электронных компонентов отечественного и импортного производства напрямую от производителей и с крупнейших мировых складов;
- Поставка более 17-ти миллионов наименований электронных компонентов;
- Поставка сложных, дефицитных, либо снятых с производства позиций;
- Оперативные сроки поставки под заказ (от 5 рабочих дней);
- Экспресс доставка в любую точку России;
- Техническая поддержка проекта, помощь в подборе аналогов, поставка прототипов;
- Система менеджмента качества сертифицирована по Международному стандарту ISO 9001;
- Лицензия ФСБ на осуществление работ с использованием сведений, составляющих государственную тайну;
- Поставка специализированных компонентов (Xilinx, Altera, Analog Devices, Intersil, Interpoint, Microsemi, Aeroflex, Peregrine, Syfer, Eurofarad, Texas Instrument, Miteq, Cobham, E2V, MA-COM, Hittite, Mini-Circuits, General Dynamics и др.);

Помимо этого, одним из направлений компании «ЭлектроПласт» является направление «Источники питания». Мы предлагаем Вам помощь Конструкторского отдела:

- Подбор оптимального решения, техническое обоснование при выборе компонента;
- Подбор аналогов;
- Консультации по применению компонента;
- Поставка образцов и прототипов;
- Техническая поддержка проекта;
- Защита от снятия компонента с производства.



Как с нами связаться

Телефон: 8 (812) 309 58 32 (многоканальный)

Факс: 8 (812) 320-02-42

Электронная почта: org@eplast1.ru

Адрес: 198099, г. Санкт-Петербург, ул. Калинина, дом 2, корпус 4, литера А.