

# ET Series Sealed Subminiature Rocker Switches

## Features/Benefits

- Sealed against solder and cleaning process contaminants
- Rocker, bushing & case—UL 94V-0
- Small footprint—saves space
- RoHS compliant

## Typical Applications

- Telecommunications
- Instrumentation
- Computers & peripherals

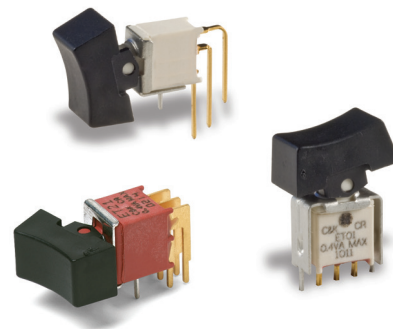

## Specifications

CONTACT RATING: B contact material: 0.4 VA max. @ 20 V AC or DC max. Q contact material: Copper alloy, silver plated. See page G-43 for additional ratings.

ELECTRICAL LIFE: ETX1 models: 60,000 make-and-break cycles at full load. All other models: 30,000 cycles.

CONTACT RESISTANCE: Below 20 mΩ typ. initial @ 2-4 V DC, 100 mA, for both silver and gold plated contacts.

INSULATION RESISTANCE: 10<sup>9</sup> Ω min.

DIELECTRIC STRENGTH: 1000 Vrms min. @ sea level.

OPERATING TEMPERATURE: -30°C to 85°C.

SOLDERABILITY: Per MIL-STD-202F method 208D, or EIA RS-186E method 9 (1 hour steam aging).

PACKAGING: Surface mount switches standard in tape and reel packaging, see page G-45 for drawings and reel information.

## Materials

CASE & BUSHING: Glass filled nylon 6/6, flame retardant, heat stabilized (UL 94V-0) or glass filled 4/6 nylon, flame retardant, heat stabilized (UL 94V-0).

ACTUATOR: Nylon, black standard. Internal o-ring seal standard with all actuators. SA surface mount: High temperature material, glass filled 46 nylon, flame retardant, heat stabilized (UL 94V-0).

SWITCH SUPPORT: Brass, matte-tin plated.

CONTACTS & TERMINALS: B contact material: Copper alloy, with gold plate over nickel plate. Q contact material: Copper alloy, silver plated. See page G-43 for additional contact materials.

TERMINAL SEAL: Epoxy.

**NOTE:** Any models supplied with Q, B, G, S, P & R contact material are RoHS compliant.

**NOTE:** Specifications and materials listed above are for switches with standard options. For information on specific and custom switches, consult Customer Service Center.

## Build-A-Switch

To order, simply select desired option from each category and place in the appropriate box. Available options are shown and described on pages G-40 thru G-44. For additional options not shown in catalog, consult Customer Service Center. All models are process sealed to withstand machine soldering temperatures and pressure wash cleaning methods.

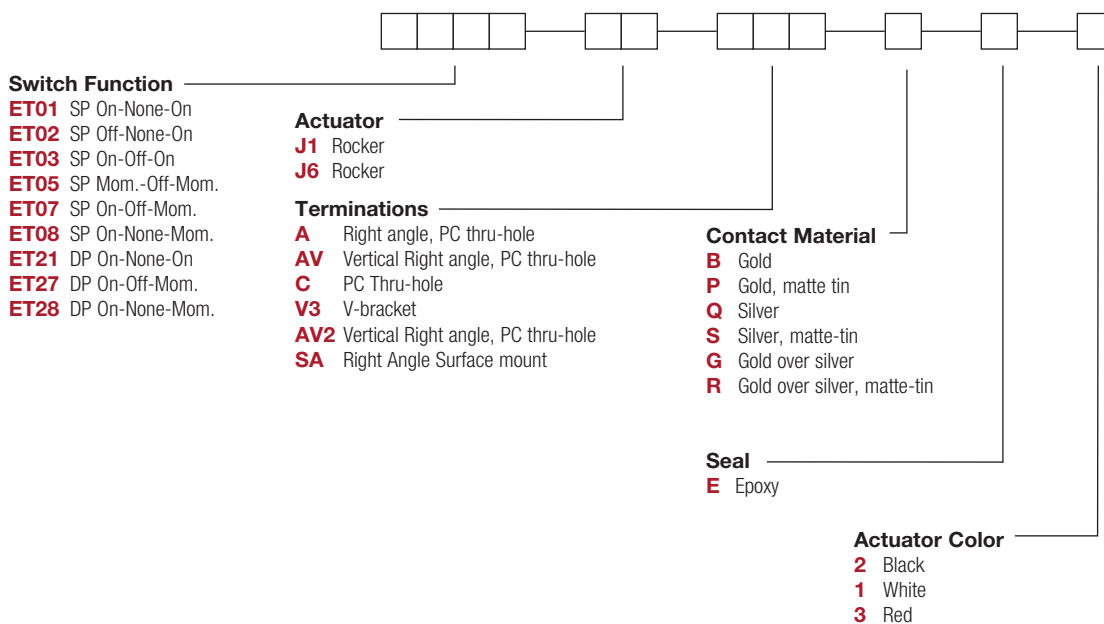

# ET Series Sealed Subminiature Rocker Switches

## SWITCH FUNCTION

NO. POLES	MODEL NO.	SWITCH FUNCTION			CONNECTED TERMINALS			SCHEMATIC
		POS. 1	POS. 2	POS. 3	POS. 1	POS. 2	POS. 3	
SP	<b>ET01</b>	ON	NONE	ON	2-3	N/A	2-1	
	<b>ET03</b>	ON	OFF	ON		OPEN		
	<b>ET05</b>	MOM.	OFF	MOM.				
	<b>ET07</b>	ON	OFF	MOM.	N/A	SPDT		
	<b>ET08</b>	ON	NONE	MOM.	OPEN	N/A	3-1	
<p><b>SPDT</b></p> <p>Part number shown: ET01J6CBE2</p> <p>ET02 Models: Omit terminal 2</p> <p>Terminal Nos. For Reference Only</p>								
DP	<b>ET21</b>	ON	NONE	ON	2-3,5-6	N/A	2-1,5-4	
	<b>ET27</b>	ON	OFF	MOM.		OPEN		
	<b>ET28</b>	ON	NONE	MOM.				
<p><b>DPDT</b></p> <p>Part number shown: ET21J6CBE2</p> <p>Terminal Nos. For Reference Only</p>								

MOM. = Momentary

All models with all options when ordered with G, S, R or Q contact material.

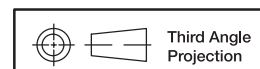

Dimensions are shown: Inches (mm)  
Specifications and dimensions subject to change



# ET Series Sealed Subminiature Rocker Switches



## J1 ROCKER

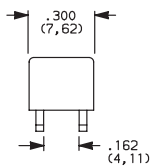
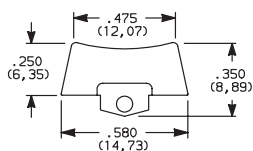

### PANEL MOUNTING

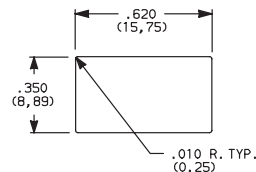

Available with all models except ET0X with A & SA & SA1 terminations.

## J6 ROCKER

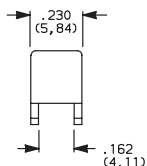
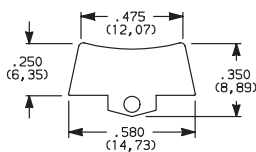

### PANEL MOUNTING

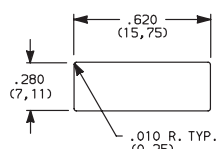

Standard with ET0X model with A & SA & SA1 terminations.

OPTION CODE	ACTUATOR COLOR
2	BLACK
1	WHITE
3	RED

Actuators available separately, see page G-45. Finish: Matte. Other colors, custom actuator markings and legends available, consult Customer Service Center.

**NOTE:** Internal o-ring actuator seal standard.

## TERMINATIONS

### C PC THRU-HOLE

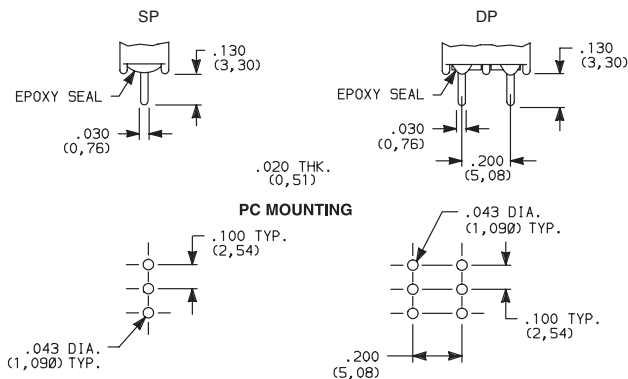

ET02 Models: Omit center hole.

### SP & DP

#### A RIGHT ANGLE, PC THRU-HOLE

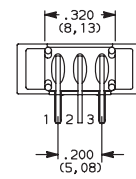
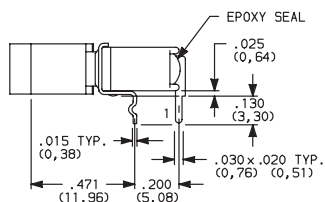
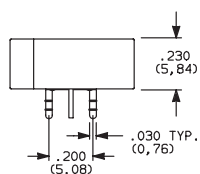

### PC MOUNTING

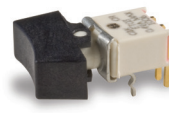
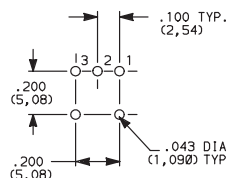

ET01J6ABE2  
Horizontal Actuation  
SPDT

Actuator Shown In Pos. 1

Not available with ET02 model.

J6 actuator std. only on ET0X models with A terminations.

#### A RIGHT ANGLE, PC THRU-HOLE

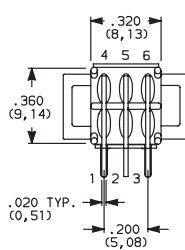
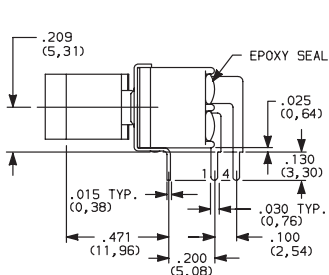
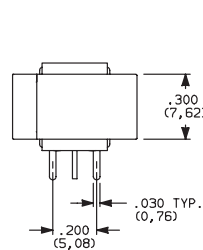

### PC MOUNTING

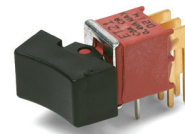
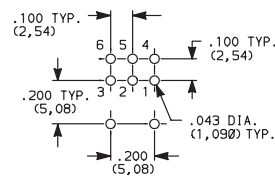

ET21J1ABE2  
Horizontal Actuation  
DPDT

Actuator Shown In Pos. 1

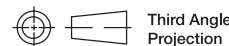

Third Angle  
Projection

Dimensions are shown: Inches (mm)  
Specifications and dimensions subject to change

Rocker

G



# ET Series Sealed Subminiature Rocker Switches

## TERMINATIONS

### AV VERTICAL RIGHT ANGLE, PC THRU-HOLE

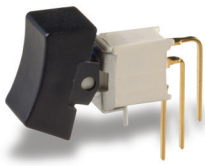

**ET01J1AVBE2**  
Vertical Actuation  
**SPDT**

Actuator Shown In Pos. 1

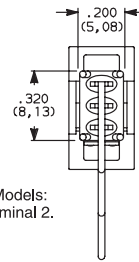
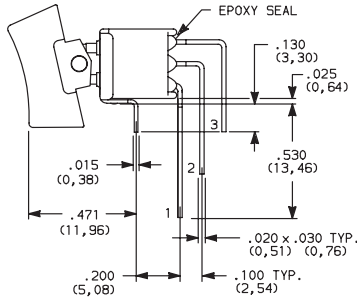
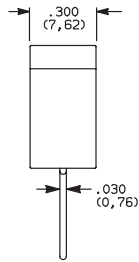

ET02 Models:  
Omit terminal 2.

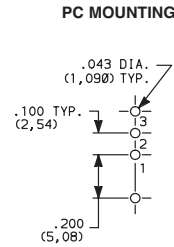

**NOTE:** Terminal bend radii and lead-in manufacturing option.

### AV VERTICAL RIGHT ANGLE, PC THRU-HOLE

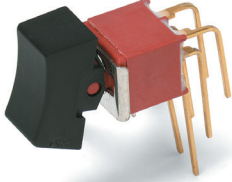

**ET21J1AVBE2**  
Vertical Actuation  
**DPDT**

Actuator Shown In Pos. 1

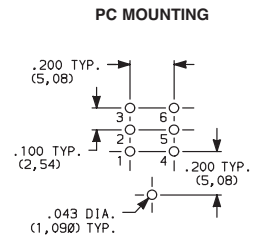
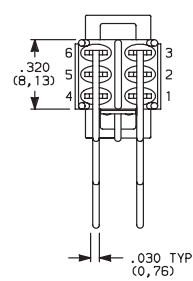
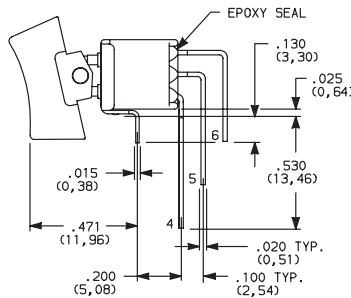
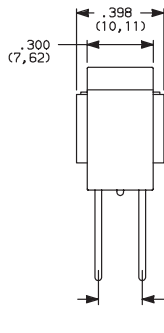

**NOTE:** Terminal bend radii and lead-in manufacturing option.

### AV2 VERTICAL RIGHT ANGLE, PC THRU-HOLE

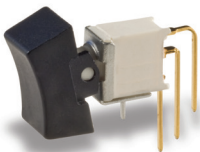

**ET01J1AV2BE2**  
Vertical Actuation  
**SPDT**

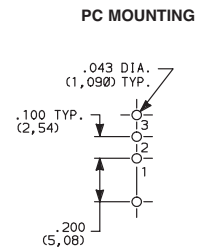
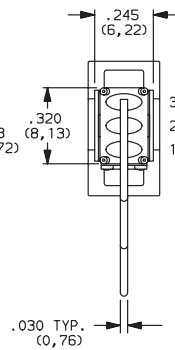
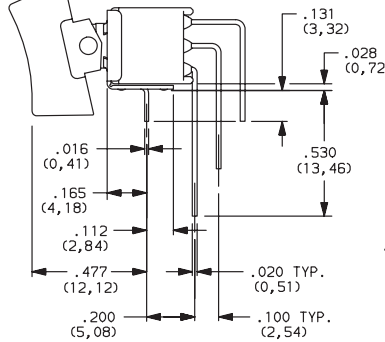
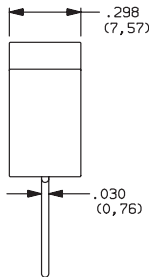

# ET Series Sealed Subminiature Rocker Switches

## TERMINATIONS

### SA RIGHT ANGLE, SURFACE MOUNT

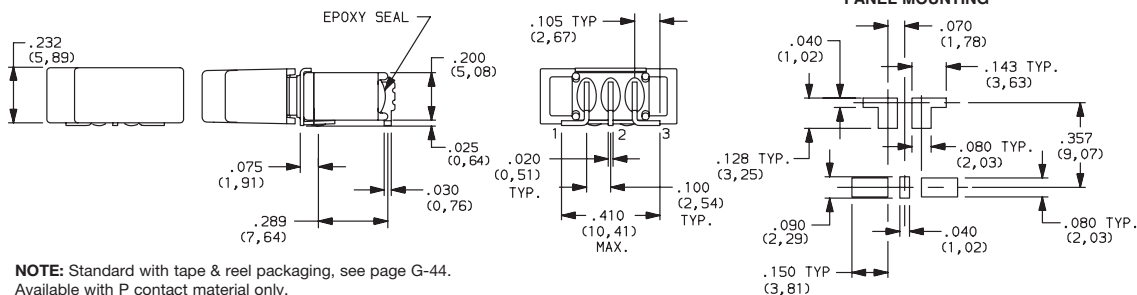

ET01J6SAPE2  
Horizontal Actuation  
SPDT

### V3 VERTICAL MOUNT, V-BRACKET

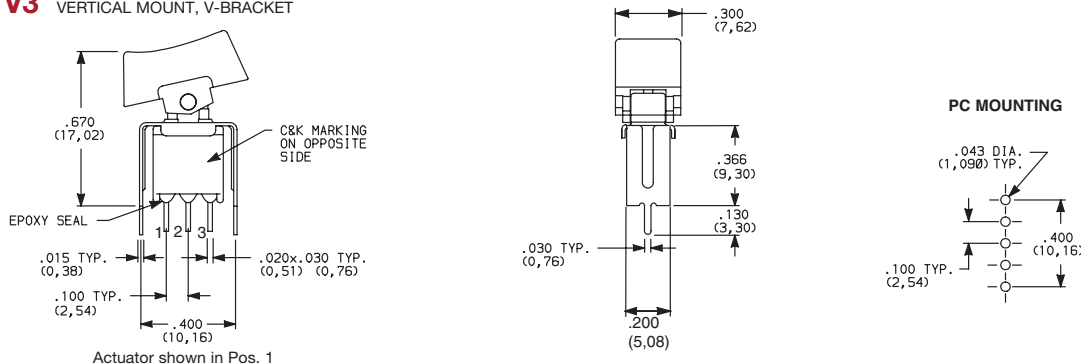

ET01J1V3BE2  
SPDT

### V3 VERTICAL MOUNT, V-BRACKET

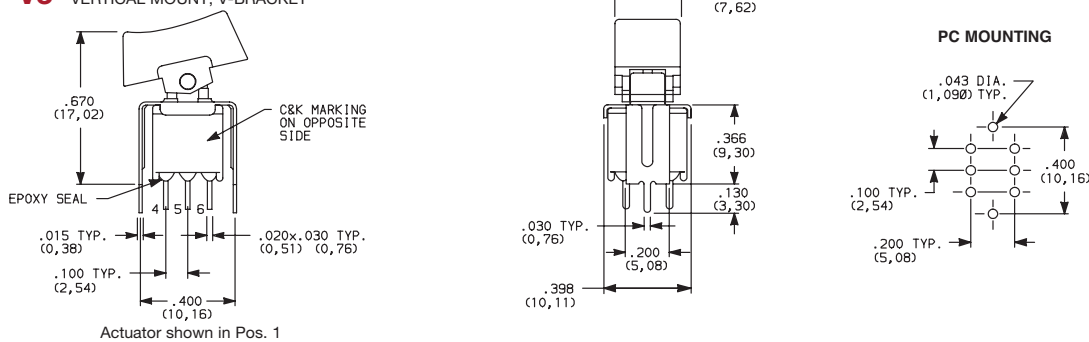

ET21J1V3BE2  
DPDT

## CONTACT MATERIAL

OPTION CODE	CONTACT MATERIAL	TERMINAL PLATING	RATINGS	
B	GOLD <sup>1</sup>	GOLD <sup>1</sup>	LOW LEVEL/ DRY CIRCUIT	0.4 VA MAX. @ 20 V AC OR DC MAX.
P		MATTE-TIN <sup>6</sup>		
Q	SILVER <sup>4,5</sup>	SILVER <sup>5</sup>	POWER	ETX1 MODELS: 3 AMPS @ 120 V AC OR 28 V DC. ALL OTHER MODELS: 2 AMPS @ 120 V AC OR 28 V DC.
S		MATTE-TIN <sup>6</sup>		
G	GOLD OVER SILVER <sup>2,3</sup>	GOLD <sup>3</sup>	LOW LEVEL/DRY CIRCUIT OR POWER	ETX1 MODELS: 0.4 VA MAX @ 20 V AC OR DC MAX. OR 3 AMPS @ 120 V AC OR 28 V DC. ALL OTHER MODELS: 0.4 VA MAX @ 20 V AC OR DC MAX. OR 2 AMPS @ 120 V AC OR 28 V DC.
R		MATTE-TIN <sup>6</sup>		

\* Note: See Technical Data section of this catalog for RoHS compliant and compatible definitions and specifications.

<sup>1</sup> CONTACTS & TERMINALS: Copper alloy, with gold plate over nickel plate.

<sup>2</sup> END CONTACTS: Coin silver, with gold plate over nickel plate.

<sup>3</sup> CENTER CONTACTS & ALL TERMINALS: Copper alloy, with gold plate over nickel plate.

<sup>4</sup> END CONTACTS: Coin silver, silver plated.

<sup>5</sup> CENTER CONTACT & ALL TERMINALS: Copper alloy, silver plated.

<sup>6</sup> TERMINALS: Copper alloy, with matte-tin over nickel plate.

**NOTE:** Any models supplied with Q, B, G, S, P & R contact material are RoHS compliant.

All models with all options when ordered with G, Q, S & R contact material.



Dimensions are shown: Inches (mm)  
Specifications and dimensions subject to change

# ET Series Sealed Subminiature Rocker Switches

SEAL



**E** EPOXY SEAL

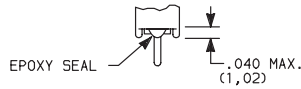

## AVAILABLE HARDWARE

J1 Actuator



PART NO.

**261A01000** WHITE  
**261A02263** BLACK  
**261A03000** RED

Material: Nylon  
Finish: Matte

NOT AVAILABLE WITH A, SA,  
SA1

J6 Actuator



PART NO.

**621C01000** WHITE  
**621C02263** BLACK  
**621C03000** RED

Material: Nylon  
Finish: Matte  
For Hi Temp, Consult Factory

NOTE: Other colors available,  
consult Customer Service Center.

## TAPE & REEL SA TERMINATION

ET01J6SABE (SHOWN)

REEL INFORMATION	
OUTSIDE DIAMETER	13.00 (330,0)
PILOT HOLE	.512 (13,0)
QUANTITY PER REEL	500

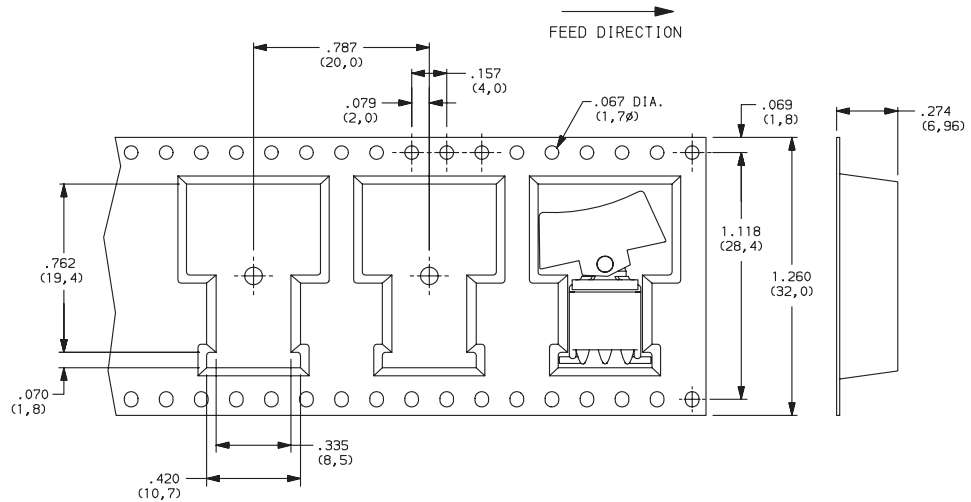

ET01J6SA1BE (SHOWN)

REEL INFORMATION	
OUTSIDE DIAMETER	13.00 (330,0)
PILOT HOLE	.795 (20,20)
QUANTITY PER REEL	450

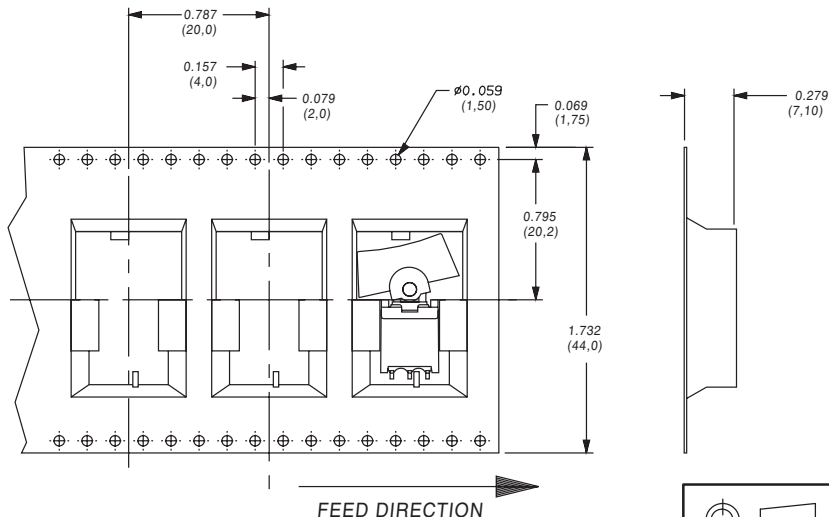

Third Angle  
Projection

Dimensions are shown: Inches (mm)  
Specifications and dimensions subject to change





Компания «ЭлектроПласт» предлагает заключение долгосрочных отношений при поставках импортных электронных компонентов на взаимовыгодных условиях!

Наши преимущества:

- Оперативные поставки широкого спектра электронных компонентов отечественного и импортного производства напрямую от производителей и с крупнейших мировых складов;
- Поставка более 17-ти миллионов наименований электронных компонентов;
- Поставка сложных, дефицитных, либо снятых с производства позиций;
- Оперативные сроки поставки под заказ (от 5 рабочих дней);
- Экспресс доставка в любую точку России;
- Техническая поддержка проекта, помощь в подборе аналогов, поставка прототипов;
- Система менеджмента качества сертифицирована по Международному стандарту ISO 9001;
- Лицензия ФСБ на осуществление работ с использованием сведений, составляющих государственную тайну;
- Поставка специализированных компонентов (Xilinx, Altera, Analog Devices, Intersil, Interpoint, Microsemi, Aeroflex, Peregrine, Syfer, Eurofarad, Texas Instrument, Miteq, Cobham, E2V, MA-COM, Hittite, Mini-Circuits, General Dynamics и др.);

Помимо этого, одним из направлений компании «ЭлектроПласт» является направление «Источники питания». Мы предлагаем Вам помощь Конструкторского отдела:

- Подбор оптимального решения, техническое обоснование при выборе компонента;
- Подбор аналогов;
- Консультации по применению компонента;
- Поставка образцов и прототипов;
- Техническая поддержка проекта;
- Защита от снятия компонента с производства.



#### Как с нами связаться

**Телефон:** 8 (812) 309 58 32 (многоканальный)

**Факс:** 8 (812) 320-02-42

**Электронная почта:** [org@eplast1.ru](mailto:org@eplast1.ru)

**Адрес:** 198099, г. Санкт-Петербург, ул. Калинина, дом 2, корпус 4, литера А.