

Power PCB Relay G6C

SPST-NO Type Breaks 10-A Loads; SPST-NO + SPST-NC Breaks 8-A Load

- Compact: 20 x 15 x 10 mm (L x W x H).
- Low power consumption: 200 mW.
- Semi-sealed or fully sealed construction available.
- Unique moving loop armature reduces relay size, magnetic interference, and contact bounce.
- Single and Dual coil latching types also available
- RoHS Compliant

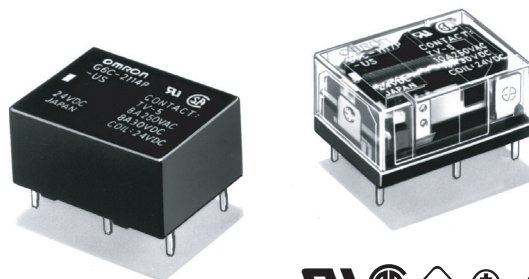

Ordering Information

| Classification | Contact form | Straight Through-hole PCB | | Self-clinching Through-hole PCB | |
|----------------------|-------------------|---------------------------|---------------|---------------------------------|---------------|
| | | Semi-sealed | Fully sealed | Semi-sealed | Fully sealed |
| Non-latching | SPST-NO | G6C-1117P-US | G6C-1114P-US | G6C-1117C-US | G6C-1114C-US |
| | SPST-NO + SPST-NC | G6C-2117P-US | G6C-2114P-US | G6C-2117C-US | G6C-2114C-US |
| Single coil latching | SPST-NO | G6CU-1117P-US | G6CU-1114P-US | G6CU-1117C-US | G6CU-1114C-US |
| | SPST-NO + SPST-NC | G6CU-2117P-US | G6CU-2114P-US | G6CU-2117C-US | G6CU-2114C-US |
| Dual coil latching | SPST-NO | G6CK-1117P-US | G6CK-1114P-US | G6CK-1117C-US | G6CK-1114C-US |
| | SPST-NO + SPST-NC | G6CK-2117P-US | G6CK-2114P-US | G6CK-2117C-US | G6CK-2114C-US |

Note: When ordering, add the rated coil voltage to the model number.

Example: G6C-1117P-US DC12

Rated coil voltage

Model Number Legend

G6C - - - DC

1 2 3 4 5 6 7 8

1. Relay Function

- None: Non-latching
- U: Single coil latching
- K: Dual coil latching

2. Contact Form

- 11: SPST-NO
- 21: SPST-NO + SPST-NC

3. Contact Type

- 1: Standard

4. Enclosure Ratings

- 4: Fully sealed
- 7: Semi-sealed

5. Terminals

- P: Straight Through-hole PCB
- C: Self-clinching Through-hole PCB

6. Approved Standards

- US: UL/CSA certified

7. Mounting Method

- None: Mount directly to PCB
- P6C: Mount to Socket

8. Rated Coil Voltage

- 3, 5, 6, 12, or 24 VDC

■ Accessories (Order Separately)

Back Connecting Sockets

| Applicable Relay | Back Connecting Socket (See note 1.) |
|--|--------------------------------------|
| G6C(U)-1114P-US-P6C G6C(U)-1117P-US-P6C G6C(U)-2114P-US-P6C G6C(U)-2117P-US-P6C | P6C-06P |
| G6CK-1114P-US-P6C G6CK-1117P-US-P6C G6CK-2114P-US-P6C G6CK-2117P-US-P6C | P6C-08P |

- Note:** 1. Not applicable to the self-clinching versions.
The operating current for the socket is 5 A max.
2. Use the G6C(U)-□□□□P-US-**P6C** if mounting relays in a P6C Socket.

| | |
|-----------------|--------|
| Removal Tool | P6B-Y1 |
| Hold-down Clips | P6B-C2 |

Specifications

■ Contact Ratings

| Item | SPST-NO | | SPST-NO+SPST-NC | |
|---|--|--|--------------------------------------|--|
| | Resistive load ($\cos\phi = 1$) | Inductive load ($\cos\phi = 0.4$; L/R = 7 ms) | Resistive load ($\cos\phi = 1$) | Inductive load ($\cos\phi = 0.4$; L/R = 7 ms) |
| Rated load | 10 A at 250 VAC; 10A at 30 VDC | 5 A at 250 VAC; 5 A at 30 VDC | 8 A at 250 VAC; 8A at 30 VDC | 3.5 A at 250 VAC; 3.5 A at 30 VDC |
| Contact material | Ag Alloy (Cd free) | | | |
| Rated carry current | 10 A | | 8 A | |
| Max. switching voltage | 380 VAC, 125 VDC (the case of latching 250 VAC, 125 VDC) | | | |
| Max. switching current | 10 A | | 8 A | |
| Max. switching capacity | 2,500 VA, 300 W | 1,250 VA, 220 W | 2,000 VA, 240 W | 875 VA, 170 W |
| Min. permissible load (reference value - see note) | 10 mA at 5 VDC | | | |

Note: P level: $\lambda_{60} = 0.1 \times 10^{-6}$ operations

■ Coil Data

Non-latching

| Rated voltage (VDC) | Rated current (mA) | Coil resistance (Ω) | Coil inductance (ref. value) (H) | | Pick-up voltage | Dropout voltage | Maximum voltage | Power consumption (mW) |
|------------------------|-----------------------|---------------------------------|-------------------------------------|-------------|-----------------|-----------------|----------------------|---------------------------|
| | | | Armature OFF | Armature ON | | | | |
| 3 | 67 | 45 | 0.078 | 0.067 | 70% max. | 10% min. | 160% max. at 23°C | Approx. 200 |
| 5 | 40 | 125 | 0.22 | 0.18 | | | | |
| 6 | 33.30 | 180 | 0.36 | 0.29 | | | | |
| 12 | 16.70 | 720 | 1.32 | 1.13 | | | | |
| 24 | 8.30 | 2,880 | 4.96 | 4.19 | | | | |

- Note:** 1. The rated current and coil resistance are measured at a coil temperature of 23°C with a tolerance of $\pm 10\%$.
2. Operating characteristics are measured at a coil temperature of 23°C.

Single Coil Latching Type

| Rated voltage (VDC) | Rated current (mA) | Coil resistance (Ω) | Coil inductance (ref. value) (H) | | Set pick-up voltage | Reset pick-up voltage | Maximum voltage | Power consumption (mW) |
|---------------------|--------------------|---------------------|----------------------------------|-------------|---------------------|-----------------------|-------------------|------------------------|
| | | | Armature OFF | Armature ON | % of rated voltage | | | |
| 3 | 67 | 45 | 0.09 | 0.06 | 70% max. | 70% min. | 160% max. at 23°C | Approx. 200 |
| 5 | 40 | 125 | 0.25 | 0.20 | | | | |
| 6 | 33.30 | 180 | 0.36 | 0.24 | | | | |
| 12 | 16.70 | 720 | 1.75 | 1.17 | | | | |
| 24 | 8.30 | 2,880 | 5.83 | 3.84 | | | | |

Dual Coil Latching Type

| Rated voltage (VDC) | Rated current (mA) | Coil resistance (Ω) | Coil inductance (ref. value) (H) | | | | Set pick-up voltage | Reset pick-up voltage | Maximum voltage | Power consumption (mW) |
|---------------------|--------------------|---------------------|----------------------------------|-------------|--------------|-------------|---------------------|-----------------------|--------------------|------------------------|
| | | | Set Coil | | Reset Coil | | | | | |
| | | | Armature OFF | Armature ON | Armature OFF | Armature ON | % of rated voltage | | | |
| 3 | 93.50 | 32.10 | 0.03 | 0.02 | 0.03 | 0.02 | 70% max. | 70% max. | 130% max. at 23°C) | Approx. 280 |
| 5 | 56 | 89.30 | 0.07 | 0.06 | 0.08 | 0.07 | | | | |
| 6 | 46.70 | 129 | 0.10 | 0.08 | 0.12 | 0.10 | | | | |
| 12 | 23.30 | 514 | 0.37 | 0.32 | 0.47 | 0.38 | | | | |
| 24 | 11.70 | 2,056 | 1.56 | 1.18 | 1.46 | 1.13 | | | | |

- Note:** 1. The rated current and coil resistance are measured at a coil temperature of 23°C with a tolerance of ±10%.
 2. Operating characteristics are measured at a coil temperature of 23°C.
 3. The minimum pulse width of the set and reset voltage is 20 ms.

■ Characteristics

| | | |
|------------------------------------|-------------------------------|--|
| Contact resistance | | 30 mΩ max. |
| Operate (set) time | | 10 ms max. (mean value: approx. 5 ms) |
| Release (reset) time | | 10 ms max. (mean value: approx. 2 ms; latching types: mean value: approx. 5 ms) |
| Bounce time | | 5 ms max. (Approx. 3 ms typical) |
| Min. set/reset signal width | | Latching type: 20 ms (at 23°C) |
| Max. switching frequency | Mechanical | 18,000 operations/hr |
| | Electrical | 1,800 operations/hr (under rated load) |
| Insulation resistance | | 1,000 MΩ min. (at 500 VDC, at 250 VDC between set coil and reset coil) |
| Dielectric strength | | 2,000 VAC, 50/60 Hz for 1 min between coil and contacts 2,000 VAC, 50/60 Hz for 1 min between contacts of different polarity 1,000 VAC, 50/60 Hz for 1 min between contacts of same polarity 250 VAC, 50/60 Hz for 1 min between set and reset coils (double winding latching type) |
| Surge withstand voltage | | 6,000 V (1.2 x 50 μs) between coil and contacts (latching types: 4,500 V, 1.2 x 50 μs) |
| Vibration resistance | Mechanical durability | 10 to 55 Hz, 1.5-mm double amplitude |
| | Malfunction durability | 10 to 55 Hz, 1.5-mm double amplitude |
| Shock resistance | Mechanical durability | 1,000 m/s ² (Approx. 100G) |
| | Malfunction durability | 100 m/s ² (Approx. 10G) |
| Ambient temperature | | Operating: -25°C to 70°C (with no icing) |
| Ambient humidity | | Operating: 5% to 85% |
| Service Life | Mechanical: | 50,000,000 operations min. (at 18,000 operations/hr) |
| | Electrical: | 100,000 operations min. (at 1,800 operations/hr) See "Characteristic Data" |
| Weight | | Approx. 5.6 g |

■ Approved Standards

UL Recognized (File No. E41643) -- See note

| Model | Contact form | Coil rating | Contact rating |
|--|-------------------|-------------|--|
| G6C-1114P-US G6C-1114C-US G6C-1117P-US G6C-1117C-US | SPST-NO | 3 to 60 VDC | 10 A, 250 VAC (general use) 10 A, 30 VDC (resistive load) 1/6 hp, 125 VAC 1/4 hp, 125 VAC 1/4 hp, 250 VAC 1/3 hp, 250 VAC TV-5 (40°C, 25,000 operations) 600 W, 120 VAC (tungsten) 530 VA, 20 to 265 VAC, 2 A max. (pilot duty) 43.2 VA, 30 VDC (pilot duty) 12LRA, 2.2FLA, 30 VDC (30,000 operations) |
| G6C-2114P-US G6C-2114C-US G6C-2117P-US G6C-2117C-US | SPST-NO + SPST-NC | | 8 A, 250 VAC (general use) 8 A, 30 VDC (resistive load) 1/6 hp, 125 VAC 1/4 hp, 125 VAC 1/4 hp, 250 VAC 1/3 hp, 250 VAC TV-5 (40°C, 25,000 operations) 600 W, 120 VAC (tungsten) 530 VA, 20 to 265 VAC, 2 A max. (pilot duty) 43.2 VA, 30 VDC (pilot duty) 12LRA, 2.2FLA, 30 VDC (30,000 operations) |

Note: UL Recognition tests performed at 80°C for 6,000 operations unless otherwise specified.

CSA Certified (File No. LR31928)

| Model | Contact form | Coil rating | Contact rating |
|--|-------------------|-------------|---|
| G6C-1114P-US G6C-1114C-US G6C-1117P-US G6C-1117C-US | SPST-NO | 3 to 60 VDC | 10 A, 250 VAC (general use) 10 A, 30 VDC (resistive load) 1/6 hp, 125 VAC 1/4 hp, 125 VAC 1/4 hp, 250 VAC 1/3 hp, 250 VAC TV-5 600 W, 120 VAC (tungsten) |
| G6C-2114P-US G6C-2114C-US G6C-2117P-US G6C-2117C-US | SPST-NO + SPST-NC | 3 to 60 VDC | 8 A, 250 VAC (general use) 8 A, 30 VDC (resistive load) 1/6 hp, 125 VAC 1/4 hp, 125 VAC 1/4 hp, 250 VAC TV-5 600 W, 120 VAC (tungsten) |

VDE (Approval No. 2413) EN61810-1

| Model | Contact form | Coil rating | Contact rating | Number of test operations |
|--|-------------------|--|--|---------------------------|
| G6C-1114P-US G6C-1114C-US G6C-1117P-US G6C-1117C-US | SPST-NO | 3, 12, 24 VDC | 10 A, 250 VAC (cosφ = 1) 5 A, 250 VAC (cosφ = 0.4) | 100,000 operations |
| G6C-2114P-US G6C-2114C-US G6C-2117P-US G6C-2117C-US | SPST-NO + SPST-NC | Single-stable: 3, 5, 12, 24 VDC Latching: 5 VDC G6CU-2117P-VD: 3 VDC | 7 A, 250 VAC (cosφ = 1) 3.5 A, 250 VAC (cosφ = 0.4) | 100,000 operations |

Engineering Data

Maximum Switching Capacity SPST-NO

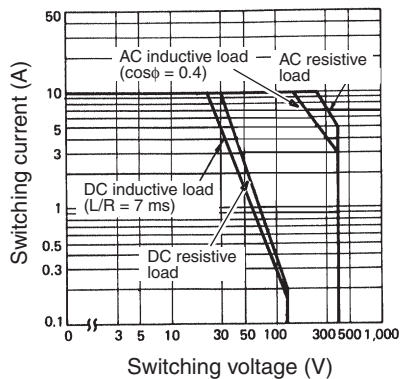

SPST-NO + SPST-NC

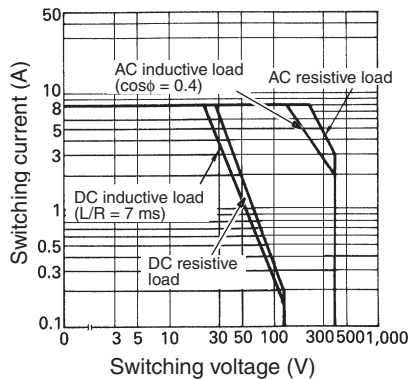

Service Life

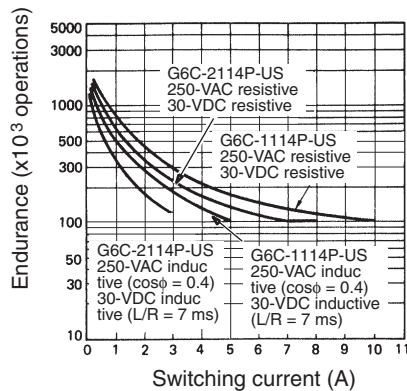

Ambient Temperature vs. Maximum Coil Voltage

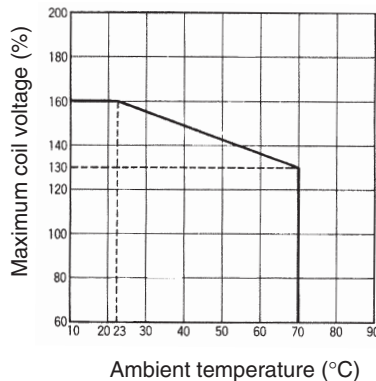

Note: The maximum coil voltage refers to the maximum value in a varying range of operating power voltage, not a continuous voltage.

Dimensions

Note: 1. All units are in millimeters unless otherwise indicated.

2. Orientation mark is indicated as follows: 

■ Non-latching

G6C-□117P-US

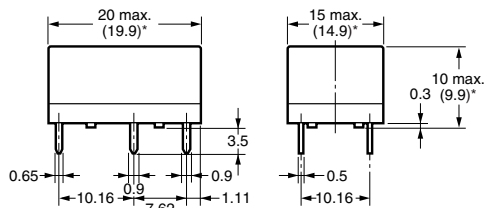
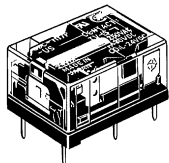

*Average value

G6C-1117P-US, G6C-1117C-US G6C-1114P-US, G6C-1114C-US Terminal Arrangement/Internal Connections (Bottom View)

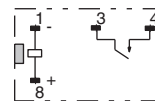

Mounting Holes (Bottom View)

Tolerance: ± 0.1

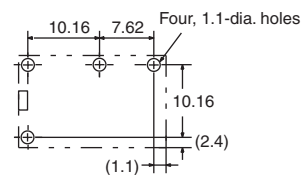

G6C-□117C-US

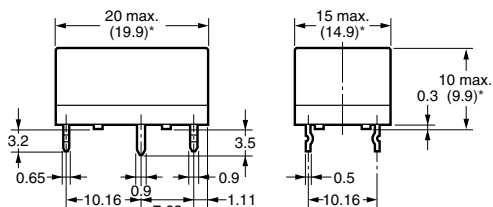
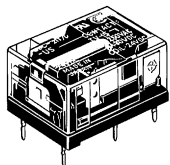

*Average value

G6C-□114P-US

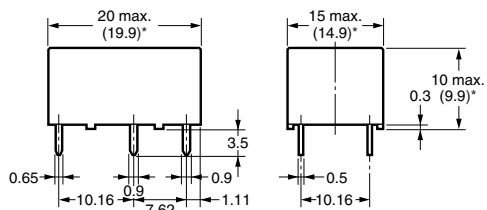
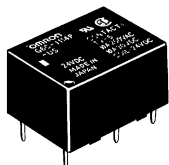

*Average value

G6C-2117P-US, G6C-2117C-US G6C-2114P-US, G6C-2114C-US Terminal Arrangement/Internal Connections (Bottom View)

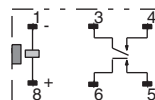

Mounting Holes (Bottom View)

Tolerance: ± 0.1

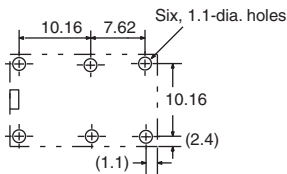

G6C-□114C-US

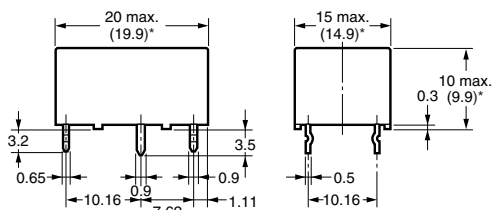
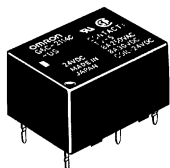

*Average value

Single Coil Latching

G6CU-□117P-US

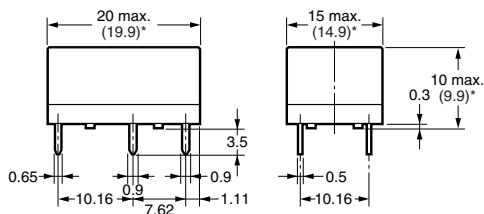
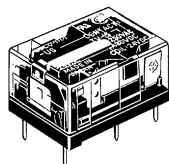

*Average value

G6CU-1117P-US, G6CU-1117C-US
G6CU-1114P-US, G6CU-1114C-US
Terminal Arrangement/Internal Connections (Bottom View)

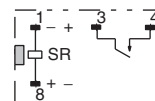

Mounting Holes (Bottom View)

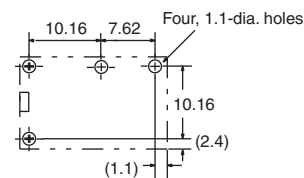

G6CU-□117C-US

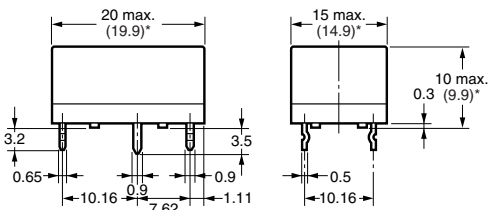
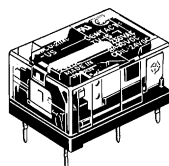

*Average value

G6CU-2117P-US, G6CU-2117C-US
G6CU-2114P-US, G6CU-2114C-US
Terminal Arrangement/Internal Connections (Bottom View)

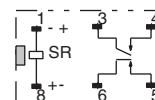

Mounting Holes (Bottom View)

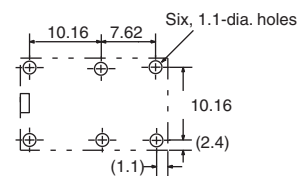

G6CU-□114P-US

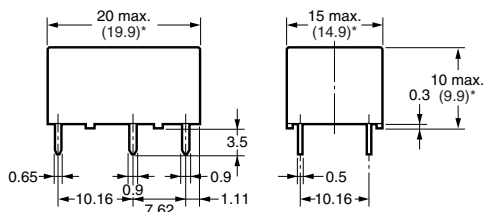
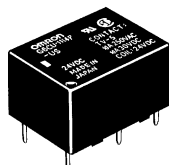

*Average value

G6CU-□114C-US

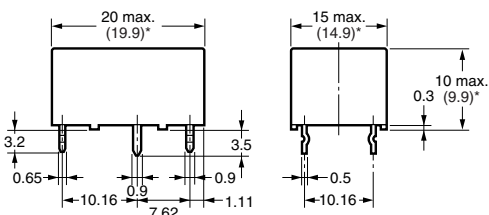
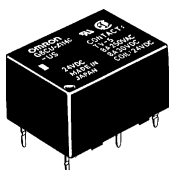

*Average value

■ Dual Coil Latching

G6CK-□117P-US

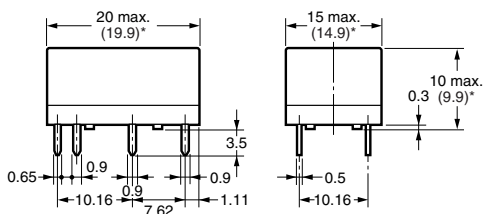
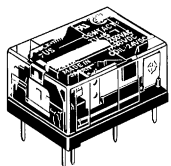

*Average value

G6CK-1117P-US, G6CK-1117C-US G6CK-1114P-US, G6CK-1114C-US Terminal Arrangement/Internal Connections (Bottom View)

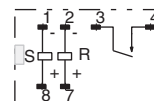

Mounting Holes (Bottom View)

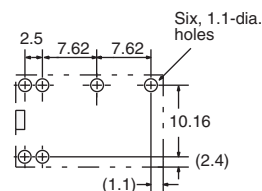

G6CK-□117C-US

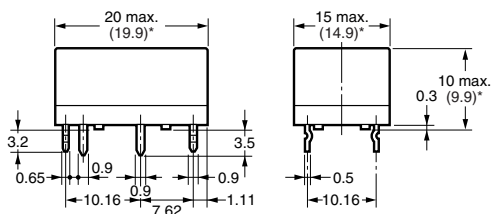
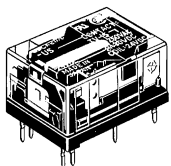

*Average value

G6CK-□114P-US

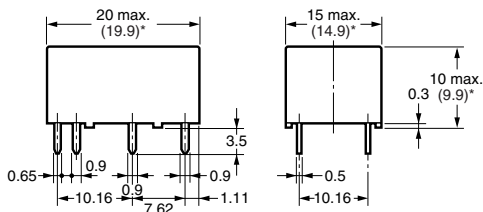
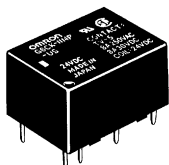

*Average value

G6CK-2117P-US, G6CK-2117C-US G6CK-2114P-US, G6CK-2114C-US Terminal Arrangement/Internal Connections (Bottom View)

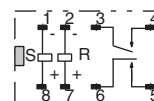

Mounting Holes (Bottom View)

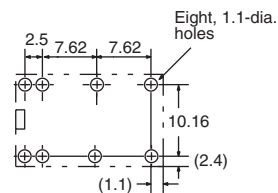

G6CK-□114C-US

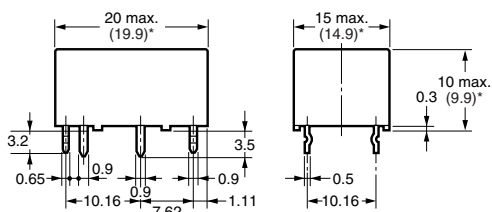
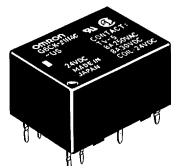

*Average value

Accessories

Back Connecting Sockets

P6C-06P

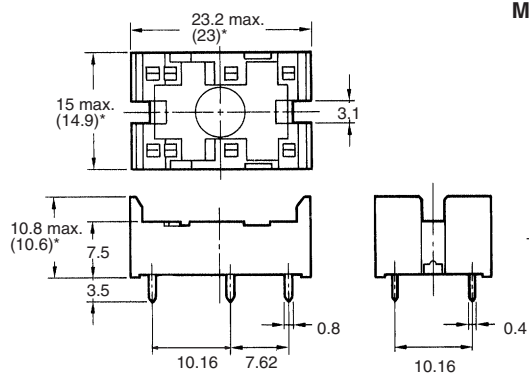
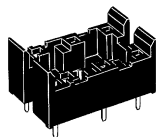

*Average value

Mounting Holes (Bottom View)

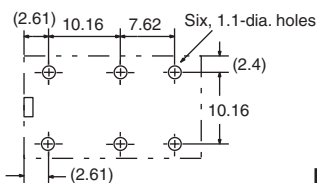

Mounting Height of Relay with Connecting Socket

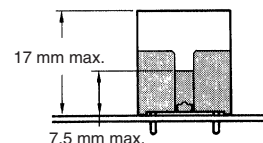

P6C-08P

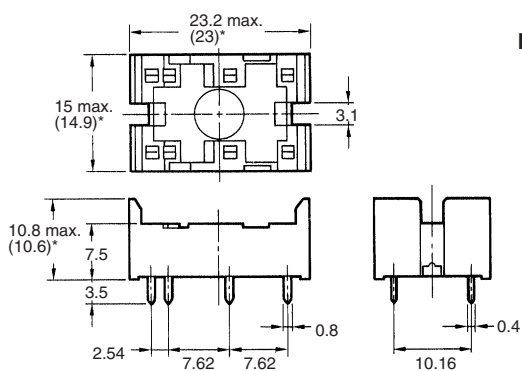
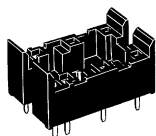

*Average value

Mounting Holes (Bottom View)

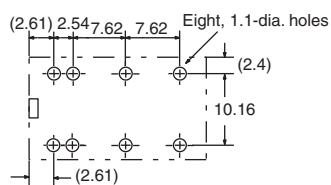

Note: Rated current of socket max. 5 A

Removal Tool

P6B-Y1

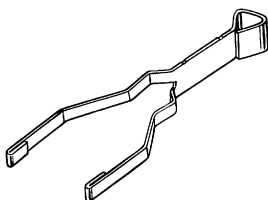

Hold-down Clips

P6B-C2

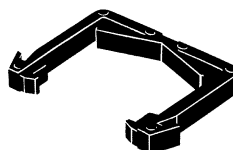

All sales are subject to Omron Electronic Components LLC standard terms and conditions of sale, which can be found at http://www.components.omron.com/components/web/webfiles.nsf/sales_terms.html

ALL DIMENSIONS SHOWN ARE IN MILLIMETERS.
To convert millimeters into inches, multiply by 0.03937. To convert grams into ounces, multiply by 0.03527.

OMRON[®]

**OMRON ELECTRONIC
COMPONENTS LLC**

55 E. Commerce Drive, Suite B
Schaumburg, IL 60173

847-882-2288

OMRON ON-LINE

Global - <http://www.omron.com>

USA - <http://www.components.omron.com>

Cat. No. X301-E-1b

09/11

Specifications subject to change without notice

Printed in USA



Компания «ЭлектроПласт» предлагает заключение долгосрочных отношений при поставках импортных электронных компонентов на взаимовыгодных условиях!

Наши преимущества:

- Оперативные поставки широкого спектра электронных компонентов отечественного и импортного производства напрямую от производителей и с крупнейших мировых складов;
- Поставка более 17-ти миллионов наименований электронных компонентов;
- Поставка сложных, дефицитных, либо снятых с производства позиций;
- Оперативные сроки поставки под заказ (от 5 рабочих дней);
- Экспресс доставка в любую точку России;
- Техническая поддержка проекта, помощь в подборе аналогов, поставка прототипов;
- Система менеджмента качества сертифицирована по Международному стандарту ISO 9001;
- Лицензия ФСБ на осуществление работ с использованием сведений, составляющих государственную тайну;
- Поставка специализированных компонентов (Xilinx, Altera, Analog Devices, Intersil, Interpoint, Microsemi, Aeroflex, Peregrine, Syfer, Eurofarad, Texas Instrument, Miteq, Cobham, E2V, MA-COM, Hittite, Mini-Circuits, General Dynamics и др.);

Помимо этого, одним из направлений компании «ЭлектроПласт» является направление «Источники питания». Мы предлагаем Вам помощь Конструкторского отдела:

- Подбор оптимального решения, техническое обоснование при выборе компонента;
- Подбор аналогов;
- Консультации по применению компонента;
- Поставка образцов и прототипов;
- Техническая поддержка проекта;
- Защита от снятия компонента с производства.



Как с нами связаться

Телефон: 8 (812) 309 58 32 (многоканальный)

Факс: 8 (812) 320-02-42

Электронная почта: org@eplast1.ru

Адрес: 198099, г. Санкт-Петербург, ул. Калинина, дом 2, корпус 4, литера А.