

Anderson Power Products' family of Euro Battery Connectors (EBC) exceeds all the requirements of DIN 43589-1 and EN 1175-1. The connector design incorporates an innovative, cost effective contact carrier for ease of assembly.

The connectors have a Degree of Protection of IP23 per IEC 60529. The acid resistance and temperature range of the PBT-PC housing exceeds the requirements of EN 1175-1. Contacts are pure copper with silver plate for maximum conductivity.

All materials meet RoHS requirements and are selected to ensure years of reliable service under adverse battery environments.

Features

- **Sturdy Advanced Polymer Housings**

PBT-PC alloy housings provides superior resistance to acids and temperature extremes

- **DIN 43589-1 Voltage Keying**

Dry-cell, wet-cell & universal keying plugs coded for 24 / 36 / 48 / 72 / 80 & 96 volts DC

- **Mating Compatibility with Connectors of Other Manufacturers**

APP "E" series connectors offer dimensional compatibility for air tube and auxiliary contacts over and above the DIN 43589-1 compatibility of housings and main contacts



- **Silver Plated Pure Copper Contacts**

For lowest voltage drop and superior performance

SPECIFICATIONS

Electrical		Mechanical	
Current Rating (Amperes) *		Life	
UL	340	a. No Load (mating cycles)	>5000
EN1175-1:1998	300	b. Under Load (Hot Plug 5 mating cycles @96V)	800A
CSA	260		
Voltage Rating		Average Mating / Unmating Force (lbf)	12
UL / CSA	600	(N)	53
EN1175-1:1998	150	Degree of Protection	IP23
Wire Range		Acid Resistance	1.38g / cm ³
- Power Contacts - AWG (mm ²)	#1/0 to 4/0 (50 / 95)	Contact Retention - minimum (lbf)	100
- Auxiliary Contacts - AWG (mm ²)	#12 to #10 (4 / 6)	(N)	445
Dielectric Withstanding Voltage (AC)	2,200	Air Tube Rating	2 bar
Average Contact Resistance (micro-ohms)	30		
Operating Temperature (°C)	-25° to 75°		
(°F)	-13° to 167°		
		Materials	
		Housing	PBT/PC blend
		Contacts	Copper alloy, silver plate
		Hardware	Steel, zinc chromate plate

* Current derating curves must be observed as current capacity will vary dependent on wire cross section and ambient temperature. Maximum current carrying capacity is measured at 40°C / 104°F using the maximum wire cross section permissible, crimped to contacts using APP recommended tooling.

ORDERING INFORMATION

Connector Part Number Selection

Series	Gender	Main Contact	Handle	Coding Key	Auxiliary Contacts & Air Tubes	Packaging
E32 **	5	50	- 1	0	2	9
5	Socket					9 Individual
00	None - Order Separately				0 None	8 Bulk
50	50 mm ² / #1/0 AWG				1 (2) Lower Auxiliary Contacts	
70	70 mm ² / #2/0 AWG				2 (2) Upper Auxiliary Contacts	
95	95 mm ² / #3/0 AWG				4 (2) Lower Auxiliary Contacts & (2) Upper Auxiliary Contacts	
0	No			0 Grey, Wet Cell	5 Air Tube	
1	Black			2 Green, Dry Cel	6 Air Tube & (2) Upper Auxiliary Contacts	
				3 Yellow, Universal		

Accessories

Part Number	Description
E320-21	Twin air tube
E16-89	Handle kit - low profile
E32-89	Handle kit - high profile
A320LP-MK	Latch plate for mating side
A320HL-MK	Handle with latch & hardware
994G4	Manual release bracket & handle
993G4	Manual release mounting plate for mating half

** A supplemental auxiliary holder will ship with each pair of contacts.

HEADQUARTERS: Anderson Power Products®, 13 Pratts Junction Road, Sterling, MA 01564-2305 USA T:978-422-3600 F:978-422-3700

EUROPE: Anderson Power Products® Ltd., Unit 3, Europa Court, Europa Boulevard, Westbrook, Warrington, Cheshire, WA5 7TN United Kingdom T: +44 (0) 1925 428390 F: +44 (0) 1925 520203

ASIA / PACIFIC: IDEAL Anderson Asia Pacific Ltd., Unit 922-928 Topsail Plaza, 11 On Sum Street, Shatin N.T., Hong Kong T: +(852) 2636 0836 F: +(852) 2635 9036

CHINA: IDEAL Anderson Technologies (Shenzhen) Ltd., Block A8 Tantou Western Industrial Park, Songgang Baoan District, Shenzhen, P.R. China 518105 T: +(86) 755 2768 2118 F: +(86) 755 2768 2218

TAIWAN: IDEAL Anderson Asia Pacific Ltd., Taiwan Branch, 4F-2, No.116, Dadun 20th St., Situn District, Taichung City 407, Taiwan (R.O.C.) T: +(886) 4 2310 6451 F: +(886) 4 2310 6460

www.andersonpower.com

ORDERING INFORMATION

Tooling

Part

Number	Description
1387G3	Hydraulic tool for power contacts
E160-36	Extraction tool

Note: For tooling die information, see tooling chart on website.

DIMENSIONS

Socket Contact

Part Number	- Wire -		- ØA -		- ØB -		- C -	
	mm ²	AWG	mm	in.	mm	in.	mm	in.
320-1150	50	#1/0	14.5	0.57	11.0	0.43	65.5	2.58
320-1170	70	#2/0	17.0	0.67	13.0	0.51	65.5	2.58
320-1195	95	#3/0	19.8	0.78	15.0	0.59	70.5	2.78

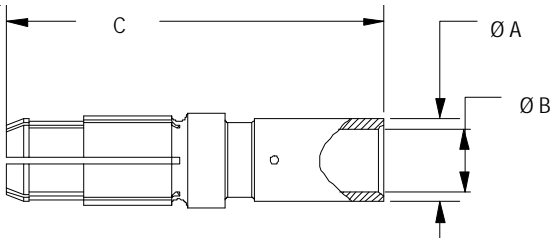

Upper Auxiliary Contact

E320-35 upper auxiliary contact for 4 mm² (#12 AWG)

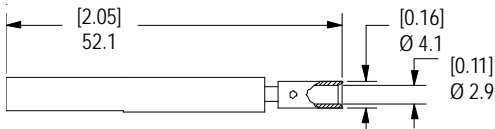

Lower Auxiliary Contact

160-13 lower auxiliary contact for 6 mm² (#10 AWG)

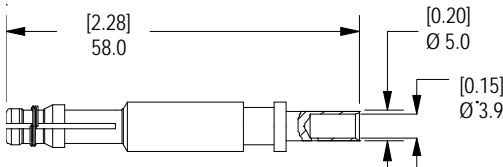

Handle / Lever Assembly / Latch

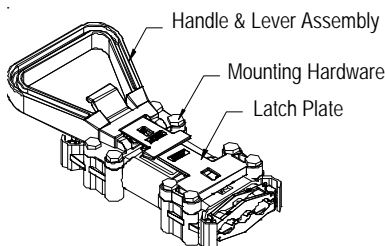

Housing Front View

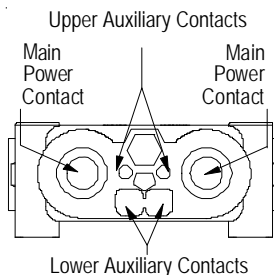

TEMPERATURE CHARTS

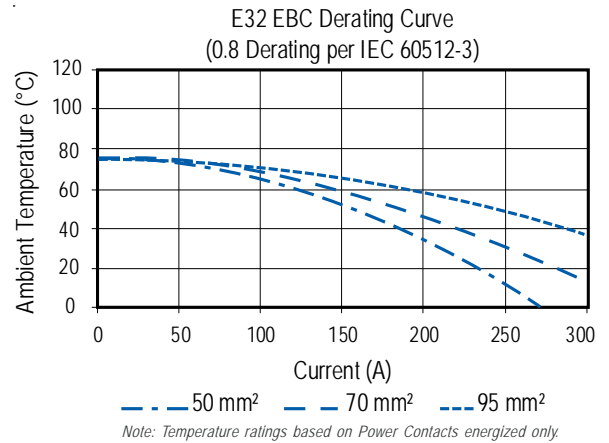
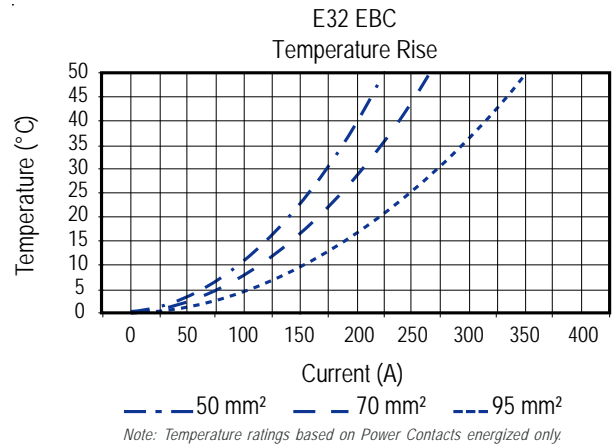

Housing Side View

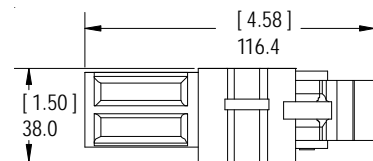

Housing Top View

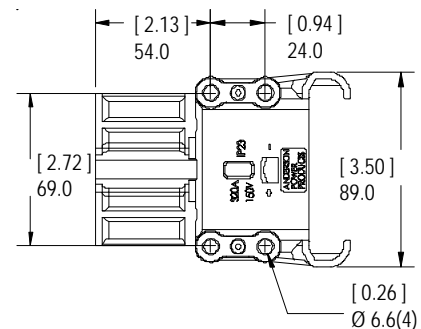



Компания «ЭлектроПласт» предлагает заключение долгосрочных отношений при поставках импортных электронных компонентов на взаимовыгодных условиях!

Наши преимущества:

- Оперативные поставки широкого спектра электронных компонентов отечественного и импортного производства напрямую от производителей и с крупнейших мировых складов;
- Поставка более 17-ти миллионов наименований электронных компонентов;
- Поставка сложных, дефицитных, либо снятых с производства позиций;
- Оперативные сроки поставки под заказ (от 5 рабочих дней);
- Экспресс доставка в любую точку России;
- Техническая поддержка проекта, помощь в подборе аналогов, поставка прототипов;
- Система менеджмента качества сертифицирована по Международному стандарту ISO 9001;
- Лицензия ФСБ на осуществление работ с использованием сведений, составляющих государственную тайну;
- Поставка специализированных компонентов (Xilinx, Altera, Analog Devices, Intersil, Interpoint, Microsemi, Aeroflex, Peregrine, Syfer, Eurofarad, Texas Instrument, Miteq, Cobham, E2V, MA-COM, Hittite, Mini-Circuits, General Dynamics и др.);

Помимо этого, одним из направлений компании «ЭлектроПласт» является направление «Источники питания». Мы предлагаем Вам помощь Конструкторского отдела:

- Подбор оптимального решения, техническое обоснование при выборе компонента;
- Подбор аналогов;
- Консультации по применению компонента;
- Поставка образцов и прототипов;
- Техническая поддержка проекта;
- Защита от снятия компонента с производства.



Как с нами связаться

Телефон: 8 (812) 309 58 32 (многоканальный)

Факс: 8 (812) 320-02-42

Электронная почта: org@eplast1.ru

Адрес: 198099, г. Санкт-Петербург, ул. Калинина, дом 2, корпус 4, литера А.