



MICRO SWITCH™
Weather-Sealed,
Explosion-Proof Switches
CX Series



MICRO SWITCH™ CX Series

Weather-Sealed, Explosion-Proof Switches

MICRO SWITCH™ CX switches are built especially for outdoor use in hazardous atmospheres. These enclosures are constructed to withstand the pressure of an internal explosion. Flame paths cool the exploded gases to a point less than the lowest safe operating temperature of the surrounding gas.

MICRO SWITCH™ 80CX Series switches have rugged bronze housings that are designed to be resistant to salt water and other corrosive environments. They comply with the NEMA 4X requirement for protection against corrosion, in addition to NEMA enclosure standards met by other CX switches.

The product's o-ring seals make the enclosure rain tight, but are outside of required flame paths so explosion proof requirements are maintained. Unless special ordered, all basic switches operate on clockwise and counterclockwise rotation. The actuating mechanism can be field adjusted for CW or CCW operation only. No tools are required.

What makes our switches better?

- Building block design allows for digital switching outputs, or 4 mA to 20 mA analog output, or digital switching outputs with a 4 mA to 20 mA analog output
- Weather sealed to NEMA and IP ratings
- UL, CSA, ATEX, IEC Ex, INMETRO certified for hazardous (explosive) environments
- Designed with the end user in mind, these switches help to create user-friendly interfaces with broad application possibilities to help meet the challenges of many different environments
- Available with gold contacts, low-temp seals, and bronze corrosion-resistant housing



COST OPTIMIZATION
RELIABILITY • GLOBALLY ACCEPTED

Features and Benefits

WELL-SUITED FOR EXPLOSIVE ENVIRONMENTS

MICRO SWITCH™ CX Series switches are certified for applicable portions of **NEMA 7 and 9** for hazardous locations (explosive environments). Select CX switches are certified to ATEX, IEC Ex, and INMETRO specifications for global applications.

Available with digital or analog outputs

WATERTIGHT AND DUST-TIGHT FOR OUTDOOR USE

Due to its engineering design and sealing (NEMA 1, 3, 4, 4X, 6, 6P, and 13), the MICRO SWITCH™ CX Series is rated for **rain, wind, snow, ice, and blowing dust environments**.

CORROSION RESISTANT

Bronze housing material is available on 80CX Series catalog listings.

4 MA TO 20 MA ANALOG OUTPUT AVAILABLE

Allows for use in accurate positioning applications, such as those found on seaside grain and fuel-loading docks, oil and gas wells, refineries, chemical plants, and more.

MEETS HAZARDOUS AREA REQUIREMENTS

UL Listed, file #E14274, Analog UL file #E68247, CSA Certified, file #LR57324, ATEX certificate KEMA 01ATEX2111 X, IEC Ex certificate IEC Ex TSA 06.003X, and INMETRO certificate TUV 14.0553.

OPTIONAL HOUSING CHOICES

CX Series switches offer a **choice of rugged cast aluminum or bronze housings**. Both housings withstand harsh environments, and bronze is available for use in corrosive environments.

UNIQUE DESIGN FEATURES

Featuring **field-adjustability**, the CX Series allows pretravel, overtravel, and actuating sequence to be field adjusted without tools (all basics can be adjusted individually). Rotary types convert in seconds to clockwise, counterclockwise, or both-way operation. These features **may help to reduce set up time** while allowing for quick and easy changes to switch operation.

Potential Applications



INDUSTRIAL

- Seaside grain and fuel loading docks that may require explosion proof and corrosion resistant switches
- Oil and gas wells, refineries, and fuel storage facilities that may require explosion proof and corrosion resistant switches
- Chemical plants with corrosive environments



Table 1. Specifications

Characteristic	Parameter
Actuators	side rotary (choice of levers), side rotary (with flat shaft), plunger actuator
Housing material	aluminum with electrostatic epoxy coating or corrosion resistant bronze
Termination	3/4 x 14 NPT, M25 x 1,5 mm conduit
Sealing	NEMA 1, 3, 4, 4X, 6, 6P, and 13; IP66
Hazardous area designations	NEMA 7: Class I, Div.1 & Div. 2, Groups B (14CX, 16CX, 24CX, 26CX, 36CX only), C, and D; NEMA 9: Class II, Div.1 & Div. 2, Groups E, F, and G ATEX/IEC Ex, INMETRO (Gas) II 2 G; Exd IIC T6 ATEX/IEC Ex, INMETRO (Dust) II 2 D; Exd tD A21 T85°C
Operating temperature	-25 °C to 85 °C [-13 °F to 185 °F]
Agency approvals	UL Listed, file #E14274, Analog UL file #E68247 CSA Certified, file #LR57324 ATEX certificate KEMA 01ATEX2111 X IEC Ex certificate IEC Ex TSA 06.003X INMETRO certificate TUV 14.0553

Table 2. Electrical Ratings (in amperes)

Rating Code	Switch Description	UL/CSA
A	BZ basic switch, SPDT	15 A 120/240/480 Vac; 1/8 HP, 120 Vac 1/4 HP, 240 Vac; 0.5 A, 125 Vdc; 0.25 A, 250 Vdc
B	BA basic switch, SPDT	20 A 120/240/480 Vac; 1 HP, 120 Vac; 2 HP, 240 Vac; 0.5 A, 125 Vdc; 0.25 A, 250 Vdc
C	DT basic switch, DPDT	10 A 120/240/480 Vac, 0.3 A 125 Vdc; 0.15 A, 250 Vdc
D	HS basic switch (hermetic sealed), SPDT	1 A, 125 Vac; 5 A, 28 Vdc
F	BZ basic switch (gold contacts) SPDT	1 A, 125 Vac

Table 3. Analog Position Sensing Specifications

Specification	Parameter
Voltage compliance range	12.5 Vdc to 40 Vdc
Replacement PC board	15PA261-CX
Current signal output	4 mA to 20 mA
Span	Adjustable from 15 ° to 90 ° of angular rotation
Null	4 mA position may be set at any angular position

MICRO SWITCH™ Weather-Sealed, Explosion-Proof Switches

PRODUCT NOMENCLATURE



	1	1	CX	2	
Switch Type	Housing Style & Actuator Type	Circuitry	Switch Type	Switches	Additional Options
CX Series Hazardous Area Limit Switch	1 Short housing, side rotary	1 15 A, SPDT basic switch/es	CX Momentary	0 4 mA to 20 mA	Non-threaded thru holes
	2 Standard housing, side rotary	2 20 A, SPDT basic switch/es	CX1 Maintained	1 One switch	A Side mounting, 5/16-18(8)
	3 Short housing, plunger actuator	4 10 A, DPDT basic switch/es		2 Two switches	B Thru mounting, 3/8-24(4)
	4 Standard housing, plunger actuator	6 1 A, SPDT, hermetically sealed basic switch/es		3 Three switches	C Low temperature
	6 Short housing, black epoxy	8 4 mA to 20 mA output for position sensing		4 Four switches	E ATEX/IEC Ex/INMETRO certified with cover clamp
	7 Stand. housing, bronze material, 5/16-18 UNC-2B mtg holes	172 1 A, SPDT, gold-plated contacts, basic switch/es		5 Two switches, one CW oper., one CCW oper.	M Metric, M25 x 1.5 conduit
	8 Standard housing, bronze material				D01 Flat shaft
	9 Switch assemblies (replacement)				00 Or other numbers, various specials

Other special configurations may be available.
For more information, contact your Honeywell representative.

CX Series

Table 4. Order Guide

When factory assembled, all basic switches operate on a clockwise and counter clockwise rotation. The actuating mechanism can be field adjusted for CW or CCW operation only. No tools are required. For listings not shown, contact your Honeywell representative.

	Cat. Listing ¹	Housing Material	Cover Size	Switch Action ²	Basic Switch Type, Quantity, Circuitry	Electrical Rating (Page 4)
	11CX12	Epoxy-coated aluminum	Short	Maintained	BZ (2), SPDT each	A (15 A)
	11CX12E	Epoxy-coated aluminum	Short	Maintained	BZ (2), SPDT each	A (15 A)
	11CX2	Epoxy-coated aluminum	Short	Momentary	BZ (2), SPDT each	A (15 A)
	11CX2E	Epoxy-coated aluminum	Short	Momentary	BZ (2), SPDT each	A (15 A)
	1172CX2	Epoxy-coated aluminum	Short	Momentary	BZ (2), SPDT each	F (1 A)
	11CX5C	Epoxy-coated aluminum	Short	Momentary	BZ (2), SPDT each	A (15 A)
	11CX212	Epoxy-coated aluminum	Short	Maintained	BZ (2), SPDT each	A (15 A)
	12CX12	Epoxy-coated aluminum	Short	Maintained	BA (2), SPDT each	B (20 A)
	12CX12-D01	Epoxy-coated aluminum	Short	Maintained	BA (2), SPDT each	B (20 A)
	12CX15-D01	Epoxy-coated aluminum	Short	Maintained	BA (2), SPDT each	B (20 A)
	12CX2	Epoxy-coated aluminum	Short	Momentary	BA (2), SPDT each	B (20 A)
	12CX2A	Epoxy-coated aluminum	Short	Momentary	BA (2), SPDT each	B (20 A)
	12CX2AE	Epoxy-coated aluminum	Short	Momentary	BA (2), SPDT each	B (20 A)
	12CX5E	Epoxy-coated aluminum	Short	Momentary	BA (2), SPDT each	B (20 A)
	12CX200	Epoxy-coated aluminum	Short	Maintained	BA (2), SPDT each	B (20 A)
	14CX1E	Epoxy-coated aluminum	Short	Momentary	DT (1), DPDT	C (10 A)
	16CX1	Epoxy-coated aluminum	Short	Momentary	HS (1), SPDT	D (1 A)
	16CX1E	Epoxy-coated aluminum	Short	Momentary	HS (1), SPDT	D (1 A)
	16CX2	Epoxy-coated aluminum	Short	Momentary	HS (2), SPDT each	D (1 A)
	16CX2C	Epoxy-coated aluminum	Short	Momentary	HS (2), SPDT each	D (1 A)
16CX12	Epoxy-coated aluminum	Short	Maintained	HS (2), SPDT each	D (1 A)	
18CX0	Epoxy-coated aluminum	Short	Momentary	-	-	
18CX10	Epoxy-coated aluminum	Short	Maintained	-	-	
	21CX4	Epoxy-coated aluminum	Standard	Momentary	BZ (4), SPDT each	A (15 A)
	21CX12F	Epoxy-coated aluminum	Standard	Maintained	BZ (2), SPDT each	A (15 A)
	21CX14	Epoxy-coated aluminum	Standard	Maintained	BZ (4), SPDT each	A (15 A)
	22CX4	Epoxy-coated aluminum	Standard	Momentary	BA (4), SPDT each	B (20 A)
	24CX2	Epoxy-coated aluminum	Standard	Momentary	DT (2), DPDT each	C (10 A)
	26CX4	Epoxy-coated aluminum	Standard	Momentary	HS (4) SPDT each	D (1 A)
	26CX14	Epoxy-coated aluminum	Standard	Maintained	HS (4) SPDT each	D (1 A)
	26CX16	Epoxy-coated aluminum	Standard	Maintained	HS (4) SPDT each	D (1 A)
	281CX12	Epoxy-coated aluminum	Standard	Maintained	BZ (2) SPDT each	A (15 A)
	281CX12E	Epoxy-coated aluminum	Standard	Maintained	BZ (2) SPDT each	A (15 A)
	74CX2	Bronze	Standard	Momentary	DT (2) DPDT each	D (10 A)
	81CX2	Bronze	Standard	Momentary	BZ (2) SPDT each	A (15 A)
	82CX2A	Bronze	Standard	Momentary	BA (2) SPDT each	B (20 A)

¹ Basic switches operate nearly simultaneously in multiple switch devices

² Shafts of devices without spring return can be rotated through 360°

MICRO SWITCH™ Weather-Sealed, Explosion-Proof Switches

	Operating Torque Nm [In-lb]	Pretravel max.	Differential Travel max.	Overtravel min.	Options	Comments
	0,5 Nm [4.42 in-lb]	15°	10°	90°	–	–
	0,5 Nm [4.42 in-lb]	15°	10°	90°	ATEX/IEC Ex/INMETRO certified	–
	1,25 Nm [11.1 in-lb]	15°	10°	90°	–	–
	1,25 Nm [11.1 in-lb]	15°	10°	90°	ATEX/IEC Ex/INMETRO certified	–
	1,25 Nm [11.1 in-lb]	15°	10°	90°	–	Gold-plated switch contacts
	1,25 Nm [11.1 in-lb]	15°	10°	90°	Low temperature seals	1 switch operates CW, 1 switch operates CCW
	0,5 Nm [4.42 in-lb]	15°	10°	90°	–	Cam provides ~ 30° actuation in 360° rotation for each basic switch
	0,5 Nm [4.42 in-lb]	15°	10°	90°	–	–
	0,5 Nm [4.42 in-lb]	15°	10°	90°	–	–
	0,5 Nm [4.42 in-lb]	15°	10°	90°	Flat shaft for direct coupling	1 switch operates CW, 1 switch operates CCW
	1,25 Nm [11.1 in-lb]	15°	10°	90°	Flat shaft for direct coupling	–
	1,25 Nm [11.1 in-lb]	15°	10°	90°	Threaded mounting holes, side (8)	–
	1,25 Nm [11.1 in-lb]	15°	10°	90°	Threaded mounting holes, side (8), ATEX/IEC Ex/INMETRO certified	–
	1,25 Nm [11.1 in-lb]	15°	10°	90°	ATEX/IEC Ex/INMETRO certified	1 switch operates CW, 1 switch operates CCW
	0,5 Nm [4.42 in-lb]	–	–	–	–	Cam provides approximately 30° actuation in 360° rotation for each basic switch
	1,25 Nm [11.1 in-lb]	30°	25°	75°	ATEX/IEC Ex/INMETRO certified	–
	1,25 Nm [11.1 in-lb]	30°	20°	75°	–	Hermetic sealed basic switch
	1,25 Nm [11.1 in-lb]	30°	20°	75°	ATEX/IEC Ex/INMETRO certified	Hermetic sealed basic switch
	1,25 Nm [11.1 in-lb]	30°	20°	75°	–	Hermetic sealed basic switches
	1,25 Nm [11.1 in-lb]	30°	20°	75°	Low temperature seals	Hermetic sealed basic switches
	0,5 Nm [4.42 in-lb]	30°	20°	75°	–	Hermetic sealed basic switches
	0,5 Nm [4.42 in-lb]	–	–	–	Analog position sensing	4 mA to 20 mA
	0,5 Nm [4.42 in-lb]	–	–	–	Analog position sensing	4 mA to 20 mA
	1,25 Nm [11.1 in-lb]	15°	10°	90°	–	–
	0,5 Nm [4.42 in-lb]	15°	10°	90°	–	Two basic switches. 4 sets of cams & return springs
	0,5 Nm [4.42 in-lb]	15°	10°	90°	–	–
	1,25 Nm [11.1 in-lb]	15°	10°	90°	–	–
	1,25 Nm [11.1 in-lb]	30°	25°	75°	–	–
	1,25 Nm [11.1 in-lb]	30°	20°	75°	–	Hermetic sealed basic switches
	0,5 Nm [4.42 in-lb]	30°	20°	75°	–	Hermetic sealed basic switches
	0,5 Nm [4.42 in-lb]	30°	20°	75°	–	Hermetic sealed basic switches, two switches operate CW, two switches operate CCW
	0,5 Nm [4.42 in-lb]	15°	10°	90°	Analog position sensing (4 mA to 20 mA)	–
	0,5 Nm [4.42 in-lb]	15°	10°	90°	Analog position sensing (4 mA to 20 mA), ATEX/IEC Ex/INMETRO certified	–
	1,25 Nm [11.1 in-lb]	30°	25°	75°	–	Threaded mounting holes, side (8)
	1,25 Nm [11.1 in-lb]	15°	10°	90°	–	–
	1,25 Nm [11.1 in-lb]	15°	10°	90°	Threaded mounting holes, side (8)	–

CX Series

ASSEMBLY MODIFICATIONS

MODIFIED SHAFT ENABLES DIRECT COUPLING

CX switches are available with a 3/8 inch diameter by 3/4 inch long flatted shaft which conforms to standard NEMA motor shaft specifications. It accepts commercially available shaft couplers, permitting easy, direct coupling to most equipment actuators.

To specify a “direct-couple” CX switch: Add **DO1** to catalog listings shown in the order guides, i.e. 11CX12-**DO1**.

Flatted Shaft Version

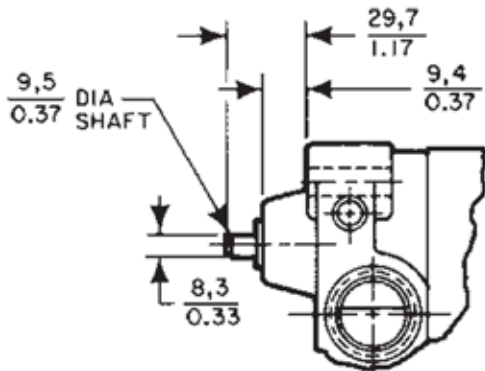

MOUNTING BRACKETS

15PA500-CX adapter bracket for mounting CX products to NAMUR footprint is available upon request.

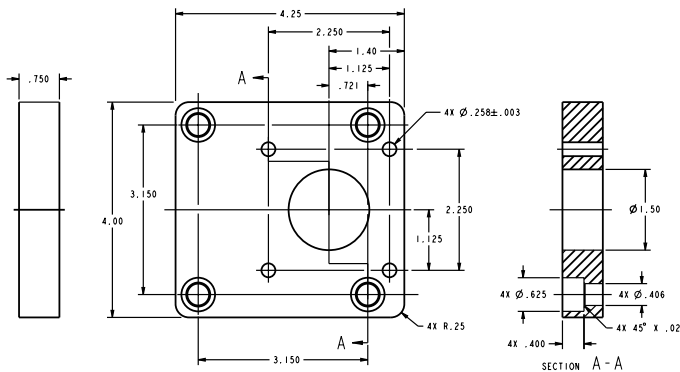

Mounting Holes

Add the letter **A** to listings with side mounting holes tapped 5/16-18(8). Example: 11CX2**A**

Add the letter **B** to listings with thru mounting holes tapped 3/8-24(4). Example: 11CX2**B**.

CX Series Replacement Basic Switch Assemblies

These assemblies are factory-adjusted to the same operating characteristics as a new CX switch. They include components subject to mechanical or electrical wear: basic switches, cams, cam followers, and springs.

To order, change the first number in the complete switch catalog listing to **9** for **rotary switches**. For example:

Rotary switch 11CX2 Replacement = **9**1CX2

Note: Basic switch assemblies for rotary actuated switches, with or without spring return, will be the same.

For example: 11CX2 and 11CX12 use **9**1CX2.

Low Temperature Switches













Add the letter **C** to listings for low temperature versions

For example: 21CX14**C** = -40 °F [-40 °C] Rotary

MICRO SWITCH™ Weather-Sealed, Explosion-Proof Switches

Table 6. Rotary Levers





Levers for use with side-rotary-actuated switches are available in a wide choice of sizes and materials. The most common listings are shown below. Rollers may be on either side of the lever to best match the external actuating mechanism.







						
Fixed lever, nylon roller LSZ51A - front mount roller LSZ51C - back mount roller		Short fixed lever, nylon roller LSZ59A - front mount roller LSZ59C - back mount roller		Offset lever, nylon roller LSZ55A - back mount roller LSZ55C - front mount roller		
						
One-way lever, nylon roller LSZ60A - front mount roller		Yoke lever, nylon rollers LSZ53A - front/back mount rollers				
						
Adj. lever, nylon roller LSZ52A - back mount roller LSZ52C - front mount roller	LSZ52J adjustable lever, nylon roller 25,4 mm [1 in]	LSZ52K adjustable lever, nylon roller 38,1 [1.5 in]	LSZ54M aluminum rod 140 mm [5.5 in]	LSZ61 loop 152 mm [6 in]	LSZ67CA** Plastic conveyor roller	LSZ68 rod w/ spring 305 mm [12 in]

** May require orientation of switch and lever to enable gravity to help restore switch's free position.
 Non-sparking rollers and actuators must be used in hazardous areas.

CX Series

Table 7. Rotary Levers Order Guide

	Catalog Listing	Material	Roller Dia. mm [in]	Roller Width mm [in]	Roller Mounting
	Fixed – 38,1 [1.5] inch radius				
	LSZ51	Rollerless	n/a	n/a	n/a
	LSZ51A	Nylon	19 [0.75]	6,35 [0.25]	Front
	LSZ51C	Nylon	19 [0.75]	6,35 [0.25]	Back
	LSZ51F	Nylon	25,4 [1.0]	12,7 [0.50]	Front
	LSZ51G	Nylon	38,1 [1.5]	6,35 [0.25]	Front
	LSZ51J	Nylon	25,4 [1.0]	12,7 [0.50]	Back
	LSZ51M	Nylon	19 [0.75]	31,7 [1.25]	Back
	LSZ51P	Nylon	19 [0.75]	12,7 [0.50]	Front
	LSZ251A (sst)	Nylon	19 [0.75]	6,35 [0.25]	Front
	LSZ251C (sst)	Nylon	19 [0.75]	6,35 [0.25]	Back
	LSZ251E (sst)	Copper alloy	19 [0.75]	6,35 [0.25]	Front
LSZ251F (sst)	Copper alloy	19 [0.75]	6,35 [0.25]	Back	
	Adjustable – 38,1 [1.5] in to 3.5 in radius				
	LSZ52	Rollerless	n/a	n/a	n/a
	LSZ52A	Nylon	19 [0.75]	6,35 [0.25]	Back
	LSZ52C	Nylon	19 [0.75]	6,35 [0.25]	Front
	LSZ52E	Nylon	19 [0.75]	33,0 [1.30]	Front
	LSZ52J	Nylon	25,4 [1.0]	12,7 [0.50]	Front
	LSZ52K	Nylon	38,1 [1.5]	6,35 [0.25]	Front
	LSZ52M	Nylon	50,8 [2.0]	6,35 [0.25]	Front
	LSZ52N	Nylon	19 [0.75]	12,7 [0.50]	Front
	LSZ252A (sst)	Nylon	19 [0.75]	6,35 [0.25]	Front
	LSZ252C (sst)	Nylon	19 [0.75]	6,35 [0.25]	Back
	LSZ252E (sst)	Copper alloy	19 [0.75]	6,35 [0.25]	Front
LSZ252F (sst)	Copper alloy	19 [0.75]	6,35 [0.25]	Back	
	Yoke – 38,1 [1.5] in radius				
	LSZ53A	Nylon	19 [0.75]	6,35 [0.25]	Front/Back
	LSZ53E	Nylon	19 [0.75]	6,35 [0.25]	Back/Front
	LSZ53M	Nylon	19 [0.75]	31,7 [1.25]	Back/Front
	LSZ53S	Nylon	19 [0.75]	6,35 [0.25]	Back/Back
	Rod				
	LSZ54	Hub only	n/a	n/a	n/a
	LSZ54M	Alum., 140 mm [5.5 in]	Ø 3,2 [Ø 0.125]	n/a	n/a
	LSZ54N	Stainless, 330 mm [13 in]	Ø 3,2 [Ø 0.125]	n/a	n/a
	LSZ54P	Plastic rod, 305 mm [12 in]	Ø6,85 [Ø 0.27]	n/a	n/a
LSZ54W	Plastic rod, 183 mm [7.2 in]	Ø6,85 [Ø 0.27]	n/a	n/a	
	Offset – 38,1 [1.5] in radius				
	LSZ55	Rollerless	n/a	n/a	n/a
	LSZ55A	Nylon	19 [0.75]	6,35 [0.25]	Back
	LSZ55C	Nylon	19 [0.75]	6,35 [0.25]	Front
	LSZ55E	Nylon	19 [0.75]	12,7 [0.50]	Front
	LSZ55K	Nylon	38,1 [1.5]	6,35 [0.25]	Front

	Catalog Listing	Material	Roller Dia. mm [in]	Roller Width mm [in]	Roller Mounting
	Short fixed – 1.3 in radius				
	LSZ59A	Nylon	19 [0.75]	6,35 [0.25]	Front
	LSZ59C	Nylon	19 [0.75]	6,35 [0.25]	Back
	One-way roller lever				
	LSZ60A	Nylon	19 [0.75]	6,35 [0.25]	Front
	Flexible loop				
	LSZ61	Ø 4,8 [Ø 0.19] Nylatron	152 mm [6 in] flexible loop		
	LSZ618	Ø 4,8 [Ø 0.19] Nylatron	241 mm [9.5 in] flexible loop		
	LSZ54	Hub only	n/a	n/a	n/a
	Spring rod				
	LSZ68	Delrin rod, 305 mm [12 in]	Ø 6,35 [0.25]	n/a	n/a
	LSZ617	Delrin rod, 406 mm [16 in]	Ø 6,35 [0.25]	n/a	n/a
	LSZ686	Delrin rod, 152 mm [6 in]	Ø 6,35 [0.25]	n/a	n/a
	Rubber roller levers				
	LSZ51Y	Rubber	50 [2.0]	12,7 [0.5]	front
	LSZ55Y	Rubber	50 [2.0]	12,7 [0.5]	front
	LSZ52Y	Rubber	50 [2.0]	12,7 [0.5]	front
	Plastic roller levers				
LSZ67AA (conveyor)*	Plastic	38,1 [1.5]	96,5 [3.8]	n/a	

* May require orientation of switch and lever to enable gravity to help restore switch to free position.

CX Series

ATEX COVER CLAMP ASSEMBLY FOR EUROPEAN COMPLIANCE

To specify a CX switch with ATEX, IEC Ex, or INMETRO certifications, add the letter "E" to the end of the catalog listing: 11CX2E.

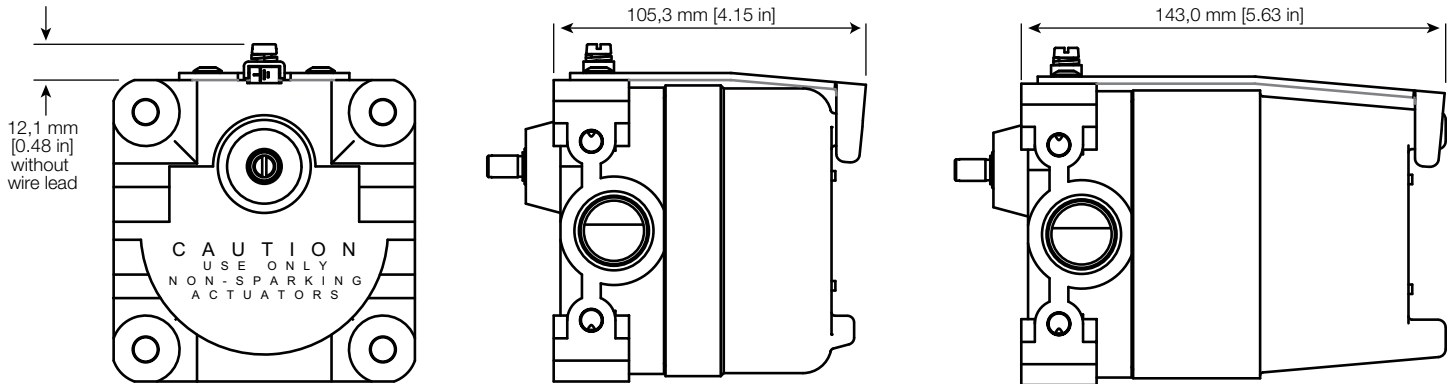

This Honeywell datasheet supports the following MICRO SWITCH™ CX Series Hazardous Location Switch Listings

1172CX12	12CX106	16CX12B-D01	21CX14-D01	281CX12E	81CX4
1172CX2	12CX12	16CX12C	21CX14E	281CX12HM	82CX2
11CX1	12CX12-D01	16CX1C	21CX16	281CX12HM-D01	82CX2A
11CX11B-D01	12CX15	16CX1E	21CX16E	281CX12HM-D01E	84CX12
11CX12	12CX15-D01	16CX2	21CX4	281CX12HME	84CX2
11CX12C	12CX2	16CX200	21CX4C	281CX2	86CX2
11CX12-D01	12CX200	16CX2C	21CX4E	281CX2HM	9172CX4
11CX12E	12CX200E	16CX2E	21CX4HM	284CX106	91CX2
11CX12HM	12CX200ME	16CX5C	21CX6	284CX12	91CX4
11CX12HM-D01	12CX2A	18CX0	22CX4	284CX2	92CX2
11CX12HM-D01E	12CX2AE	18CX0HM	24CX12	286CX2E	92CX200
11CX15-D01	12CX2E	18CX10	24CX12HM-D01	3172CX2	92CX5
11CX1B-D01	12CX5	18CX106	24CX2	31CX1	94CX2
11CX1C	12CX5A	18CX10E	24CX200	31CX1E	96CX1
11CX1E	12CX5A-2A	18CX10HM	24CX2A-2A	36CX1	
11CX2	12CX5E	18CX10HM-D01	24CX2E	36CX1E	
11CX212	14CX1	18CX10HM-D01E	24CX5A	41CX4	
11CX2B	14CX11	2172CX14C	26CX14	61CX11-D01	
11CX2-D01E	14CX1E	21CX12	26CX16	61CX12-D01	
11CX2E	15PA148-CX	21CX12F	26CX4	64CX12-D01	
11CX2HM	15PA261-CX	21CX12F-D01	26CX4C	74CX2	
11CX5C	15PA500-CX	21CX13	27CX100	8172CX2	
11CX5CE	16CX1	21CX14	27CX100E	81CX14	
12CX1	16CX12	21CX14C	281CX12	81CX2	

MICRO SWITCH™ Weather-Sealed, Explosion-Proof Switches

ADDITIONAL INFORMATION

The following associated literature is available on the Honeywell web site at sensing.honeywell.com:

- Product installation instructions
- Product range guide
- Product nomenclature tree
- MICRO SWITCH™ Hazardous Area Switches Brochure
- Product application-specific information
 - Limit and enclosed switch reference standards
 - Application Note: Sensors and switches for industrial manual process valves
 - Application Note: Sensors and switches in oil rig applications
 - Application Note: Sensors and switches in valve actuators and valve positioners
 - Application Note: Sensors and switches in valves and flow meters

WARNING

PERSONAL INJURY

DO NOT USE these products as safety or emergency stop devices or in any other application where failure of the product could result in personal injury.

Failure to comply with these instructions could result in death or serious injury.

WARNING

MISUSE OF DOCUMENTATION

- The information presented in this product sheet is for reference only. Do not use this document as a product installation guide.
- Complete installation, operation, and maintenance information is provided in the instructions supplied with each product.

Failure to comply with these instructions could result in death or serious injury.

WARRANTY/REMEDY

Honeywell warrants goods of its manufacture as being free of defective materials and faulty workmanship. Honeywell's standard product warranty applies unless agreed to otherwise by Honeywell in writing; please refer to your order acknowledgement or consult your local sales office for specific warranty details. If warranted goods are returned to Honeywell during the period of coverage, Honeywell will repair or replace, at its option, without charge those items it finds defective. **The foregoing is buyer's sole remedy and is in lieu of all other warranties, expressed or implied, including those of merchantability and fitness for a particular purpose. In no event shall Honeywell be liable for consequential, special, or indirect damages.**

While we provide application assistance personally, through our literature and the Honeywell website, it is up to the customer to determine the suitability of the product in the application.

Specifications may change without notice. The information we supply is believed to be accurate and reliable as of this printing. However, we assume no responsibility for its use.

Find out more

Honeywell serves its customers through a worldwide network of sales offices, representatives and distributors. For application assistance, current specifications, pricing or name of the nearest Authorized Distributor, contact your local sales office.

To learn more about Honeywell's sensing and control products, call **+1-815-235-6847** or **1-800-537-6945**, visit **sensing.honeywell.com**, or e-mail inquiries to **info.sc@honeywell.com**

Sensing and Control
Honeywell
1985 Douglas Drive North
Golden Valley, MN 55422
honeywell.com

The Honeywell logo is displayed in a bold, red, sans-serif font.



Компания «ЭлектроПласт» предлагает заключение долгосрочных отношений при поставках импортных электронных компонентов на взаимовыгодных условиях!

Наши преимущества:

- Оперативные поставки широкого спектра электронных компонентов отечественного и импортного производства напрямую от производителей и с крупнейших мировых складов;
- Поставка более 17-ти миллионов наименований электронных компонентов;
- Поставка сложных, дефицитных, либо снятых с производства позиций;
- Оперативные сроки поставки под заказ (от 5 рабочих дней);
- Экспресс доставка в любую точку России;
- Техническая поддержка проекта, помощь в подборе аналогов, поставка прототипов;
- Система менеджмента качества сертифицирована по Международному стандарту ISO 9001;
- Лицензия ФСБ на осуществление работ с использованием сведений, составляющих государственную тайну;
- Поставка специализированных компонентов (Xilinx, Altera, Analog Devices, Intersil, Interpoint, Microsemi, Aeroflex, Peregrine, Syfer, Eurofarad, Texas Instrument, Miteq, Cobham, E2V, MA-COM, Hittite, Mini-Circuits, General Dynamics и др.);

Помимо этого, одним из направлений компании «ЭлектроПласт» является направление «Источники питания». Мы предлагаем Вам помощь Конструкторского отдела:

- Подбор оптимального решения, техническое обоснование при выборе компонента;
- Подбор аналогов;
- Консультации по применению компонента;
- Поставка образцов и прототипов;
- Техническая поддержка проекта;
- Защита от снятия компонента с производства.



Как с нами связаться

Телефон: 8 (812) 309 58 32 (многоканальный)

Факс: 8 (812) 320-02-42

Электронная почта: org@eplast1.ru

Адрес: 198099, г. Санкт-Петербург, ул. Калинина, дом 2, корпус 4, литера А.