

THIS DRAWING IS UNPUBLISHED. RELEASED FOR PUBLICATION
 © COPYRIGHT - By - ALL RIGHTS RESERVED.

P	LTR	DESCRIPTION	DATE	DWN	APVD
	A2	REVISED PER ECR-16-014891	22FEB2017	KK	SE

PROJECT	PRJ-16-000909157
PART NO.	X-2308348-X
DESCRIPTION	CRIMP FLANGES LARGE
CUSTOMER	GENERAL MARKET

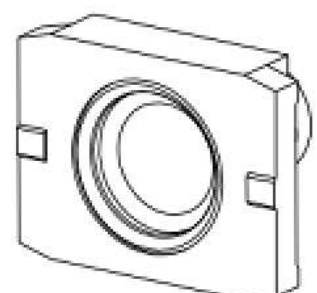
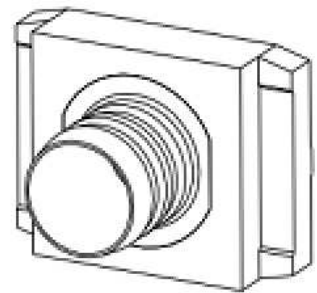
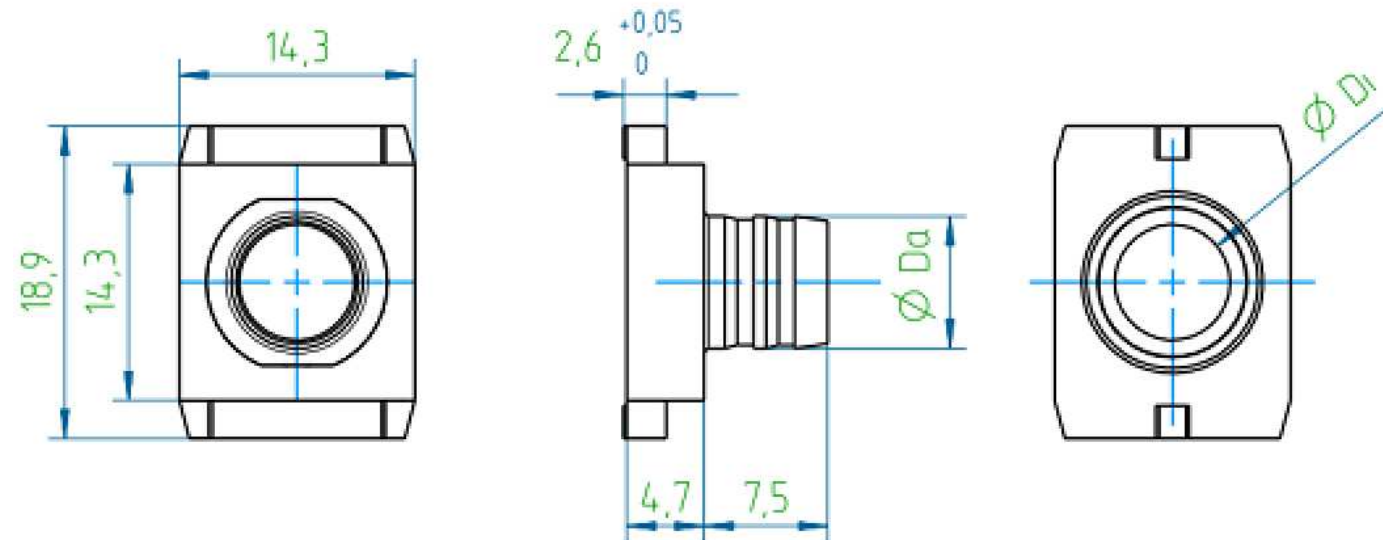

PART NO.	DESCRIPTION	Di	Da
2-2308348-7	CRIMP FLANGE 17 (LARGE)	11.0	12.0
2-2308348-6	CRIMP FLANGE 16 (LARGE)	10.5	11.5
2-2308348-5	CRIMP FLANGE 15 (LARGE)	10.0	11.0
2-2308348-4	CRIMP FLANGE 14 (LARGE)	9.5	10.5
2-2308348-3	CRIMP FLANGE 13 (LARGE)	9.0	10.0
2-2308348-2	CRIMP FLANGE 12 (LARGE)	8.5	9.5
2-2308348-1	CRIMP FLANGE 11 (LARGE)	8.0	9.0
2-2308348-0	CRIMP FLANGE 10 (LARGE)	7.6	8.5
1-2308348-9	CRIMP FLANGE 9 (LARGE)	7.0	8.0
1-2308348-8	CRIMP FLANGE 8 (LARGE)	6.5	7.5
1-2308348-7	CRIMP FLANGE 7 (LARGE)	6.0	7.0
1-2308348-6	CRIMP FLANGE 6 (LARGE)	5.5	6.5
1-2308348-5	CRIMP FLANGE 5 (LARGE)	5.0	6.0
1-2308348-4	CRIMP FLANGE 4 (LARGE)	4.5	5.5
1-2308348-3	CRIMP FLANGE 3 (LARGE)	4.0	5.0
1-2308348-2	CRIMP FLANGE 2 (LARGE)	3.5	4.5
1-2308348-1	CRIMP FLANGE 1 (LARGE)	3.0	4.0

NOTES:

- FINISHING PROCESS: Cu2/Sn4 (FLANGE).
- WEIGHT: 6.6 g.

THIS DRAWING IS A CONTROLLED DOCUMENT.		DWN KIRAN K 29JUL2016	TE Connectivity CRIMP FLANGES LARGE	
DIMENSIONS: mm		CHK GUNASEKHAR G 29JUL2016		
TOLERANCES UNLESS OTHERWISE SPECIFIED: DIN ISO 2768 m.		APVD GUNASEKHAR G 29JUL2016	NAME	
0 PLC ± - 1 PLC ± - 2 PLC ± - 3 PLC ± - 4 PLC ± - ANGLES ± -		PRODUCT SPEC	SIZE	
MATERIAL		APPLICATION SPEC	CAGE CODE	DRAWING NO
FINISH		WEIGHT	A3	00779
		CUSTOMER DRAWING	RESTRICTED TO	
		SCALE	SHEET	REV
		NTS	1 OF 2	A2

THIS DRAWING IS UNPUBLISHED. RELEASED FOR PUBLICATION
 © COPYRIGHT - By - ALL RIGHTS RESERVED.

REVISIONS					
P	LTR	DESCRIPTION	DATE	DWN	APVD
-	-	SEE SHEET 1	-	-	-

CRIMP BARREL, CRIMP INSERT AND CRIMP TOOL SELECTION PROCEDURE

SELECTION CHART AND CRIMP TOOLS

Step	Description	Example
1.	Measure the outside cable diameter (3 times on different places at different angles)	OD = 6.5mm
2.	Strip the cable and remove the cable braiding	
3.	Measure the diameter of the inner cable bundle including the foil	ID = 4.4mm
4.	Select the crimp flange with a hole diameter next up to the cable bundle diameter	PN 2-2308349-1, ID=4.5mm, OD=5.5mm
5.	Calculate the recommended barrel inner diameter with the following formula: <i>Recommended Inner crimp barrel diameter = OD of crimp flange + 2x(thickness of the cable jacket) + 0.2mm</i>	Thickness cable jacket = (6.5-4.4)/2=1.05mm Barrel ID= 5.5mm + 2x1.05 + 0.2mm = 7.8mm
6.	Select the crimp barrel with the next size up	PN 1-2308350-7, ID=8.0mm, OD= 9.0mm
7.	Order the correct crimp tool + crimp insert using the crimp barrel selection matrix	PN 1-2823557-1 & 1-2823558-3

Picture	PN Crimp Barrel	Inner diameter	Outer diameter	PN Recommended crimp insert
	1-2308350-1	5.0	6.0	1-2823558-8
	1-2308350-2	5.5	6.5	1-2823558-9
	1-2308350-3	6.0	7.0	2-2823558-0
	1-2308350-4	6.5	7.5	2-2823558-1
	1-2308350-5	7.0	8.0	1-2823558-1
	1-2308350-6	7.5	8.5	1-2823558-2
	1-2308350-7	8.0	9.0	1-2823558-3
	1-2308350-8	8.5	9.5	1-2823558-4
	1-2308350-9	9.0	10.0	1-2823558-5
	2-2308350-0	9.5	10.5	1-2823558-6
	2-2308350-1	10.0	11.0	1-2823558-7
	2-2308350-2	10.5	11.5	2-2823558-9
	2-2308350-3	11.0	12.0	3-2823558-0
	2-2308350-4	11.5	12.5	3-2823558-1
	2-2308350-5	11.7	13.0	3-2823558-2
	2-2308350-6	12.0	13.0	3-2823558-3
	2-2308350-7	12.5	13.5	3-2823558-4
	2-2308350-8	13.0	14.0	3-2823558-5
2-2308350-9	13.7	15.0	3-2823558-6	
3-2308350-0	14.0	15.0	3-2823558-7	
3-2308350-1	14.5	15.5	3-2823558-8	
3-2308350-2	16.0	17.0	3-2823558-9	



1-2823559-1 stripping tool



1-2314418-2 Crimp flange insertion tool

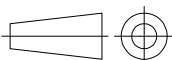

Crimp tool 1-2823557-1
Crimp insert X-2823558-X

THIS DRAWING IS A CONTROLLED DOCUMENT.		DWN KIRAN K 29JUL2016	 TE Connectivity		
DIMENSIONS: mm		CHK GUNASEKHAR G 29JUL2016			
		APVD GUNASEKHAR G 29JUL2016	NAME CRIMP FLANGES LARGE		
TOLERANCES UNLESS OTHERWISE SPECIFIED:		PRODUCT SPEC	RESTRICTED TO		
0 PLC ± -		APPLICATION SPEC	SIZE	CAGE CODE	DRAWING NO
1 PLC ± -		—	A3	00779	C-2308348
2 PLC ± -		—	SCALE NTS SHEET 2 OF 2 REV A2		
3 PLC ± -		—	CUSTOMER DRAWING		
4 PLC ± -		—			
ANGLES ± -		—			
MATERIAL		FINISH			
-		-			



Компания «ЭлектроПласт» предлагает заключение долгосрочных отношений при поставках импортных электронных компонентов на взаимовыгодных условиях!

Наши преимущества:

- Оперативные поставки широкого спектра электронных компонентов отечественного и импортного производства напрямую от производителей и с крупнейших мировых складов;
- Поставка более 17-ти миллионов наименований электронных компонентов;
- Поставка сложных, дефицитных, либо снятых с производства позиций;
- Оперативные сроки поставки под заказ (от 5 рабочих дней);
- Экспресс доставка в любую точку России;
- Техническая поддержка проекта, помощь в подборе аналогов, поставка прототипов;
- Система менеджмента качества сертифицирована по Международному стандарту ISO 9001;
- Лицензия ФСБ на осуществление работ с использованием сведений, составляющих государственную тайну;
- Поставка специализированных компонентов (Xilinx, Altera, Analog Devices, Intersil, Interpoint, Microsemi, Aeroflex, Peregrine, Syfer, Eurofarad, Texas Instrument, Miteq, Cobham, E2V, MA-COM, Hittite, Mini-Circuits, General Dynamics и др.);

Помимо этого, одним из направлений компании «ЭлектроПласт» является направление «Источники питания». Мы предлагаем Вам помощь Конструкторского отдела:

- Подбор оптимального решения, техническое обоснование при выборе компонента;
- Подбор аналогов;
- Консультации по применению компонента;
- Поставка образцов и прототипов;
- Техническая поддержка проекта;
- Защита от снятия компонента с производства.



Как с нами связаться

Телефон: 8 (812) 309 58 32 (многоканальный)

Факс: 8 (812) 320-02-42

Электронная почта: org@eplast1.ru

Адрес: 198099, г. Санкт-Петербург, ул. Калинина, дом 2, корпус 4, литера А.