



- Very low supply current per operator - essentially independent of supply voltage
- Low input bias current: 20 nA (temperature compensated)
- Low input offset voltage: 2 mV
- Low input offset current: 2 nA
- Input common mode voltage range includes ground
- Differential input voltage range equal to the power supply voltage
- Large output voltage swing 0 V to ( $V_{CC}^+$ ) - 1.5 V

### Description

The LM158W, LM258W, and LM358W circuits consist of two independent, high-gain, operational amplifiers (op-amps), which employ an internal frequency compensation and are specifically designed to operate from a single power supply over a wide range of voltages. The low-power supply drain is independent of the power supply voltage magnitude. Application areas include transducer amplifiers, DC gain blocks, and all the conventional op-amp circuits, which can now be more easily implemented in single power supply systems. For example, these circuits can be directly supplied with the standard +5 V, which is used in logic systems and easily provide the required interface electronics with no additional power supply. In linear mode, the input common mode voltage range includes ground. The output voltage can also swing to ground, even though operated from a single power supply voltage.

### Features

- ESD internal protection: 2 kV
- Internal frequency compensation implemented
- Large DC voltage gain: 100 dB
- Wide bandwidth (unity gain): 1.1 MHz (temperature compensated)

# Contents

|          |  |           |
|----------|--|-----------|
| <b>1</b> | <b>Schematic diagram</b> .....                                 | <b>3</b>  |
| <b>2</b> | <b>Absolute maximum ratings and operating conditions</b> ..... | <b>4</b>  |
| <b>3</b> | <b>Electrical characteristics</b> .....                        | <b>6</b>  |
| <b>4</b> | <b>Typical applications</b> .....                              | <b>11</b> |
| <b>5</b> | <b>Package information</b> .....                               | <b>13</b> |
|          | 5.1 SO8 package information .....                              | 14        |
|          | 5.2 MiniSO8 package information .....                          | 15        |
|          | 5.3 TSSOP8 package information .....                           | 16        |
| <b>6</b> | <b>Ordering information</b> .....                              | <b>17</b> |
| <b>7</b> | <b>Revision history</b> .....                                  | <b>18</b> |

# 1 Schematic diagram

Figure 1. Schematic diagram (1/2 LM158W/LM258W/LM358W)



## 2 Absolute maximum ratings and operating conditions

Table 1. Absolute maximum ratings

| Symbol     | Parameter   | LM158W/AW  | LM258W/AW   | LM358W/AW | Unit |
|------------|---|--|-------------|-----------|------|
| $V_{CC}^+$ | Supply voltage  | +32  |             |           | V    |
| $V_{in}$   | Input voltage   | -0.3 to $V_{CC}^+ + 0.3$                             |             |           |      |
| $V_{id}$   | Differential input voltage                            | -0.3 to $V_{CC}^+ + 0.3$                             |             |           |      |
|            | Output short-circuit duration <sup>(1)</sup>          | Infinite   |             |           |      |
| $I_{in}$   | Input current <sup>(2)</sup>                          | 5 mA in DC or 50 mA in AC<br>(duty cycle=10%, T=1 s) |             |           | mA   |
| $T_{oper}$ | Operating free-air temperature range                  | -55 to +125  | -40 to +105 | 0 to +70  | °C   |
| $T_{stg}$  | Storage temperature range                             | -65 to +150  |             |           |      |
| $T_j$      | Maximum junction temperature                          | 150  |             |           |      |
| $R_{thja}$ | Thermal resistance junction-to-ambient <sup>(3)</sup> |  |             |           | °C/W |
|            | SO8   | 125  |             |           |      |
|            | MiniSO8   | 190  |             |           |      |
| TSSOP8     | 120   |  |             |           |      |
| $R_{thjc}$ | Thermal resistance junction-to-case <sup>(3)</sup>    |  |             |           |      |
|            | SO8   | 40   |             |           |      |
|            | MiniSO8   | 39   |             |           |      |
|            | TSSOP8  | 37   |             |           |      |
| ESD        | HBM: human body model <sup>(4)</sup>                  | 2  |             |           | kV   |
|            | MM: machine model <sup>(5)</sup>                      | 200  |             |           | V    |
|            | CDM: charged device model <sup>(6)</sup>              | 1.5  |             |           | kV   |

- Short-circuits from the output to  $V_{CC}$  can cause excessive heating if  $V_{CC} > 15$  V. The maximum output current is approximately 40 mA independent of the magnitude of  $V_{CC}$ . Destructive dissipation can result from simultaneous short-circuits on all amplifiers.
- This input current only exists when the voltage at any of the input leads is driven negative. It is due to the collector-base junction of the input PNP transistor becoming forward biased and thereby acting as input diode clamps. In addition to this diode action, there is also NPN parasitic action on the IC chip. This transistor action can cause the output voltages of the op amps to go to the  $V_{CC}$  voltage level (or to ground for a large overdrive) for the time during which an input is driven negative. This is not destructive and normal output will be restored for input voltage higher than -0.3 V.
- Short-circuits can cause excessive heating and destructive dissipation.  $R_{th}$  are typical values.
- Human body model: a 100 pF capacitor is discharged through a 1.5 kΩ resistor between two pins of the device, done for all couples of pin combinations with other pins floating.
- Machine model: a 200 pF capacitor is charged to the specified voltage, then discharged directly between two pins of the device with no external series resistor (internal resistor < 5 Ω), done for all couples of pin combinations with other pins floating.
- Charged device model: all pins plus package are charged together to the specified voltage and then discharged directly to the ground.

Table 2. Operating conditions

| Symbol     | Parameter                                      | Value                            | Unit |
|------------|--|----------------------------------|------|
| $V_{CC}^+$ | Supply voltage                                 | 3 to 30                          | V    |
| $V_{icm}$  | Common mode input voltage range <sup>(1)</sup> | $V_{DD} - 0.3$ to $V_{CC} - 1.5$ |      |
| $T_{oper}$ | Operating free air temperature range           |                                  | °C   |
|            | LM158W   | -55 to +125                      |      |
|            | LM258W<br>LM358W                               | -40 to +105<br>0 to +70          |      |

1. When used in comparator, the functionality is guaranteed as long as at least one input remains within the operating common mode voltage range.

### 3 Electrical characteristics

**Table 3.  $V_{CC}^+ = +5\text{ V}$ ,  $V_{CC}^- = \text{ground}$ ,  $V_o = 1.4\text{ V}$ ,  $T_{\text{amb}} = +25\text{ }^\circ\text{C}$   
(unless otherwise specified)**

| Symbol                   | Parameter  | Min. | Typ. | Max. | Unit                         |
|--------------------------|--|------|------|------|------------------------------|
| $V_{io}$                 | Input offset voltage <sup>(1)</sup>  |      |      |      |                              |
|                          | LM158AW  |      | 1    | 2    | mV                           |
|                          | LM258AW, LM358AW   |      | 1    | 3    |                              |
|                          | LM158W, LM258W   |      | 2    | 5    |                              |
| LM358W                   |  | 2    | 7    |      |                              |
|                          | $T_{\text{min}} \leq T_{\text{amb}} \leq T_{\text{max}}$                                       |      |      |      |                              |
|                          | LM158AW, LM258AW, LM358AW  |      |      | 4    |                              |
|                          | LM158W, LM258W   |      |      | 7    |                              |
|                          | LM358W   |      |      | 9    |                              |
| $\Delta V_{io}/\Delta T$ | Input offset voltage drift   |      |      |      | $\mu\text{V}/^\circ\text{C}$ |
|                          | LM158AW, LM258AW, LM358AW  |      | 7    | 15   |                              |
|                          | LM158W, LM258W, LM358W   |      | 7    | 30   |                              |
| $I_{io}$                 | Input offset current   |      |      |      | nA                           |
|                          | LM158AW, LM258AW, LM358AW  |      | 2    | 10   |                              |
|                          | LM158W, LM258W, LM358W   |      | 2    | 30   |                              |
|                          | $T_{\text{min}} \leq T_{\text{amb}} \leq T_{\text{max}}$                                       |      |      |      |                              |
|                          | LM158AW, LM258AW, LM358AW  |      |      | 30   |                              |
|                          | LM158W, LM258W, LM358W   |      |      | 40   |                              |
| $\Delta I_{io}/\Delta T$ | Input offset current drift   |      |      |      | $\text{pA}/^\circ\text{C}$   |
|                          | LM158AW, LM258AW, LM358AW  |      | 10   | 200  |                              |
|                          | LM158W, LM258W, LM358W   |      | 10   | 300  |                              |
| $I_{ib}$                 | Input bias current <sup>(2)</sup>  |      |      |      | nA                           |
|                          | LM158AW, LM258AW, LM358AW  |      | 20   | 50   |                              |
|                          | LM158W, LM258W, LM358W   |      | 20   | 150  |                              |
|                          | $T_{\text{min}} \leq T_{\text{amb}} \leq T_{\text{max}}$                                       |      |      |      |                              |
|                          | LM158AW, LM258AW, LM358AW  |      |      | 100  |                              |
|                          | LM158W, LM258W, LM358W   |      |      | 200  |                              |
| $A_{vd}$                 | Large signal voltage gain  |      |      |      | V/mV                         |
|                          | $V_{CC}^+ = +15\text{ V}$ , $R_L = 2\text{ k}\Omega$ , $V_o = 1.4\text{ V}$ to $11.4\text{ V}$ | 50   | 100  |      |                              |
|                          | $T_{\text{min}} \leq T_{\text{amb}} \leq T_{\text{max}}$                                       | 25   |      |      |                              |
| SVR                      | Supply voltage rejection ratio   |      |      |      | dB                           |
|                          | $R_s \leq 10\text{ k}\Omega$ , $V_{CC}^+ = 5\text{ V}$ to $30\text{ V}$                        | 65   | 100  |      |                              |
|                          | $T_{\text{min}} \leq T_{\text{amb}} \leq T_{\text{max}}$                                       | 65   |      |      |                              |
| $I_{CC}$                 | Supply current, all amp, no load   |      |      |      | mA                           |
|                          | $T_{\text{min}} \leq T_{\text{amb}} \leq T_{\text{max}}$ , $V_{CC}^+ = +5\text{ V}$            |      | 0.7  | 1.2  |                              |
|                          | $T_{\text{min}} \leq T_{\text{amb}} \leq T_{\text{max}}$ , $V_{CC}^+ = +30\text{ V}$           |      |      | 2    |                              |

**Table 3.  $V_{CC}^+ = +5\text{ V}$ ,  $V_{CC}^- = \text{ground}$ ,  $V_o = 1.4\text{ V}$ ,  $T_{\text{amb}} = +25\text{ }^\circ\text{C}$   
(unless otherwise specified) (continued)**

| Symbol              | Parameter  | Min.                 | Typ.     | Max.                               | Unit                                 |
|---------------------|--|----------------------|----------|------------------------------------|--------------------------------------|
| $V_{\text{icm}}$    | Input common mode voltage range<br>$V_{CC}^+ = +30\text{ V}^{(3)}$<br>$T_{\text{amb}} = +25\text{ }^\circ\text{C}$<br>$T_{\text{min}} \leq T_{\text{amb}} \leq T_{\text{max}}$   | 0<br>0               |          | $V_{CC}^+ - 1.5$<br>$V_{CC}^+ - 2$ | V                                    |
| CMR                 | Common mode rejection ratio<br>$R_s \leq 10\text{ k}\Omega$<br>$T_{\text{min}} \leq T_{\text{amb}} \leq T_{\text{max}}$  | 70<br>60             | 85       |                                    | dB                                   |
| $I_{\text{source}}$ | Output current source<br>$V_{CC}^+ = +15\text{ V}$ , $V_o = +2\text{ V}$ , $V_{\text{id}} = +1\text{ V}$   | 20                   | 40       | 60                                 | mA                                   |
| $I_{\text{sink}}$   | Output sink current<br>$V_{CC}^+ = +15\text{ V}$ , $V_o = +2\text{ V}$ , $V_{\text{id}} = -1\text{ V}$<br>$V_{CC}^+ = +15\text{ V}$ , $V_o = +0.2\text{ V}$ , $V_{\text{id}} = -1\text{ V}$  | 10<br>12             | 20<br>50 |                                    | mA<br>$\mu\text{A}$                  |
| $V_{\text{OH}}$     | High level output voltage<br>$R_L = 2\text{ k}\Omega$ , $V_{CC}^+ = 30\text{ V}$<br>$T_{\text{min}} \leq T_{\text{amb}} \leq T_{\text{max}}$<br>$R_L = 10\text{ k}\Omega$ , $V_{CC}^+ = 30\text{ V}$<br>$T_{\text{min}} \leq T_{\text{amb}} \leq T_{\text{max}}$ | 26<br>26<br>27<br>27 | 27<br>28 |                                    | V                                    |
| $V_{\text{OL}}$     | Low level output voltage<br>$R_L = 10\text{ k}\Omega$<br>$T_{\text{min}} \leq T_{\text{amb}} \leq T_{\text{max}}$  |                      | 5        | 20<br>20                           | mV                                   |
| SR                  | Slew rate<br>$V_{CC}^+ = 15\text{ V}$ , $V_i = 0.5\text{ to }3\text{ V}$ , $R_L = 2\text{ k}\Omega$ , $C_L = 100\text{ pF}$ ,<br>unity gain  | 0.3                  | 0.6      |                                    | V/ $\mu\text{s}$                     |
| GBP                 | Gain bandwidth product<br>$V_{CC}^+ = 30\text{ V}$ , $f = 100\text{ kHz}$ , $V_{\text{in}} = 10\text{ mV}$ , $R_L = 2\text{ k}\Omega$ ,<br>$C_L = 100\text{ pF}$   | 0.7                  | 1.1      |                                    | MHz                                  |
| THD                 | Total harmonic distortion<br>$f = 1\text{ kHz}$ , $A_v = 20\text{ dB}$ , $R_L = 2\text{ k}\Omega$ , $V_o = 2\text{ V}_{\text{pp}}$ ,<br>$C_L = 100\text{ pF}$ , $V_o = 2\text{ V}_{\text{pp}}$   |                      | 0.02     |                                    | %                                    |
| $e_n$               | Equivalent input noise voltage<br>$f = 1\text{ kHz}$ , $R_s = 100\text{ }\Omega$ , $V_{CC}^+ = 30\text{ V}$  |                      | 55       |                                    | $\frac{\text{nV}}{\sqrt{\text{Hz}}}$ |
| $V_{o1}/V_{o2}$     | Channel separation <sup>(4)</sup><br>$1\text{ kHz} \leq f \leq 20\text{ kHz}$  |                      | 120      |                                    | dB                                   |

- $V_o = 1.4\text{ V}$ ,  $R_s = 0\text{ }\Omega$ ,  $5\text{ V} < V_{CC}^+ < 30\text{ V}$ ,  $0 < V_{\text{ic}} < V_{CC}^+ - 1.5\text{ V}$ .
- The direction of the input current is out of the IC. This current is essentially constant, independent of the state of the output so there is no change in the load on the input lines.
- The input common-mode voltage of either input signal voltage should not be allowed to go negative by more than 0.3 V. The upper end of the common-mode voltage range is  $V_{CC}^+ - 1.5\text{ V}$ , but either or both inputs can go to +32 V without damage.
- Due to the proximity of external components ensure that there is no coupling originating via stray capacitance between these external parts. Typically, this can be detected at higher frequencies because then this type of capacitance increases.

Figure 2. Open loop frequency response



Figure 3. Large signal frequency response



Figure 4. Voltage follower pulse response (large signal)

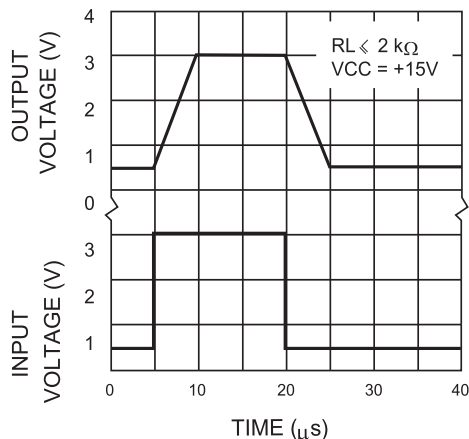


Figure 5. Voltage follower pulse response (small signal)

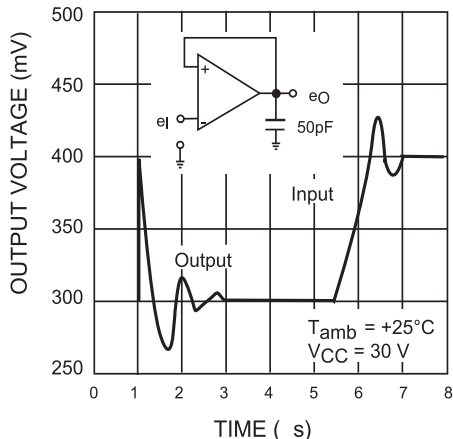


Figure 6. Input bias current vs. temperature

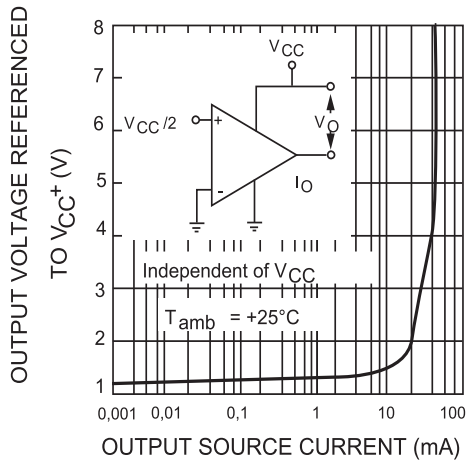


Figure 7. Output characteristics (sink)

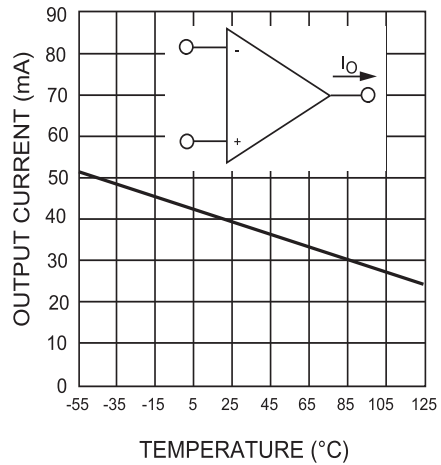




**Figure 8. Output characteristics (source)**



**Figure 9. Current limiting**



**Figure 10. Input voltage range**



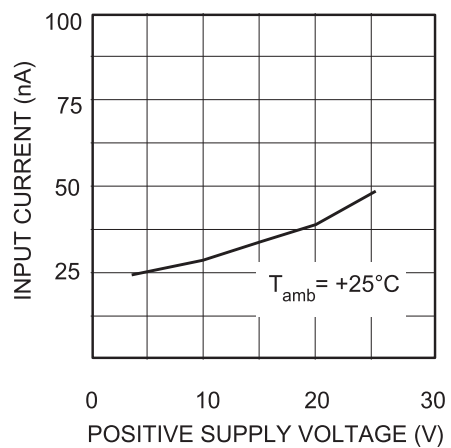
**Figure 11. Open loop gain**

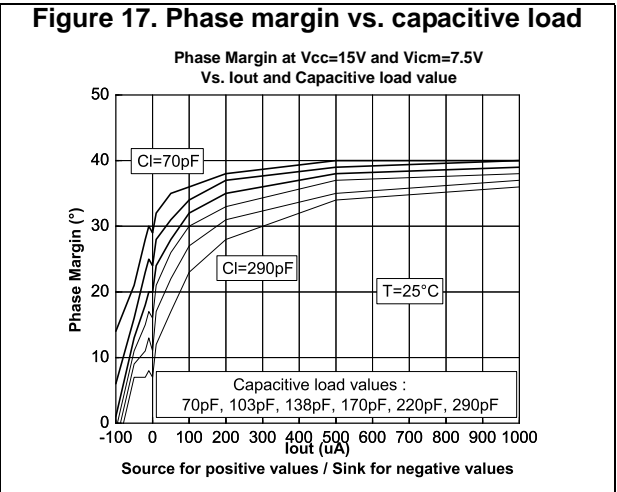
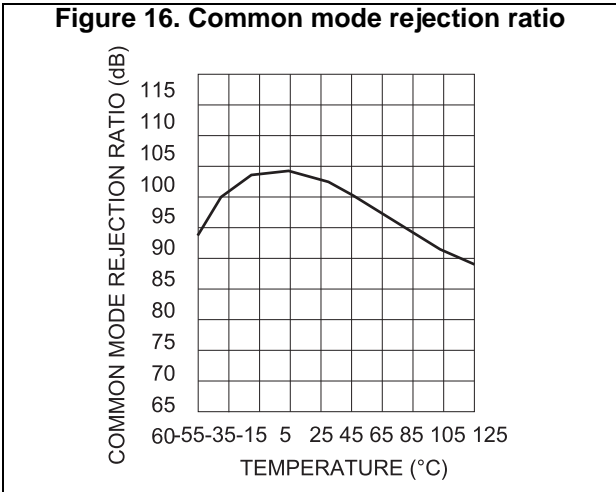


**Figure 12. Supply current**



**Figure 13. Input bias current vs. positive supply voltage**





# 4 Typical applications

Single supply voltage  $V_{CC} = +5 V_{DC}$



**Figure 24. Using symmetrical amplifiers to reduce input current**



**Figure 25. Low drift peak detector**



**Figure 26. Active band-pass filter**



## 5 Package information

In order to meet environmental requirements, ST offers these devices in different grades of ECOPACK packages, depending on their level of environmental compliance. ECOPACK specifications, grade definitions and product status are available at: [www.st.com](http://www.st.com). ECOPACK is an ST trademark.

## 5.1 SO8 package information

Figure 27. SO8 package outline

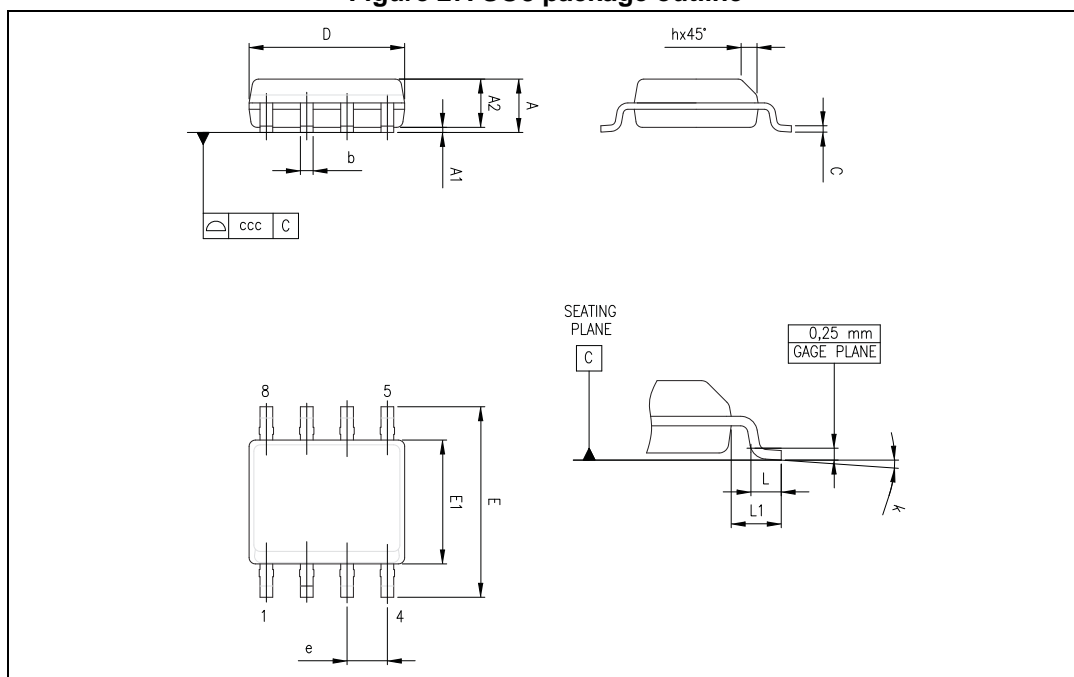


Table 4. SO8 package mechanical data

| Ref. | Dimensions  |      |      |        |       |       |
|------|-------------|------|------|--------|-------|-------|
|      | Millimeters |      |      | Inches |       |       |
|      | Min.        | Typ. | Max. | Min.   | Typ.  | Max.  |
| A    |             |      | 1.75 |        |       | 0.069 |
| A1   | 0.10        |      | 0.25 | 0.004  |       | 0.010 |
| A2   | 1.25        |      |      | 0.049  |       |       |
| b    | 0.28        |      | 0.48 | 0.011  |       | 0.019 |
| c    | 0.17        |      | 0.23 | 0.007  |       | 0.010 |
| D    | 4.80        | 4.90 | 5.00 | 0.189  | 0.193 | 0.197 |
| E    | 5.80        | 6.00 | 6.20 | 0.228  | 0.236 | 0.244 |
| E1   | 3.80        | 3.90 | 4.00 | 0.150  | 0.154 | 0.157 |
| e    |             | 1.27 |      |        | 0.050 |       |
| h    | 0.25        |      | 0.50 | 0.010  |       | 0.020 |
| L    | 0.40        |      | 1.27 | 0.016  |       | 0.050 |
| L1   |             | 1.04 |      |        | 0.040 |       |
| k    | 1°          |      | 8°   | 1°     |       | 8°    |
| ccc  |             |      | 0.10 |        |       | 0.004 |

## 5.2 MiniSO8 package information

Figure 28. MiniSO8 package outline



Table 5. MiniSO8 package mechanical data

| Ref. | Dimensions  |      |      |        |       |       |
|------|-------------|------|------|--------|-------|-------|
|      | Millimeters |      |      | Inches |       |       |
|      | Min.        | Typ. | Max. | Min.   | Typ.  | Max.  |
| A    |             |      | 1.1  |        |       | 0.043 |
| A1   | 0           |      | 0.15 | 0      |       | 0.006 |
| A2   | 0.75        | 0.85 | 0.95 | 0.030  | 0.033 | 0.037 |
| b    | 0.22        |      | 0.40 | 0.009  |       | 0.016 |
| c    | 0.08        |      | 0.23 | 0.003  |       | 0.009 |
| D    | 2.80        | 3.00 | 3.20 | 0.11   | 0.118 | 0.126 |
| E    | 4.65        | 4.90 | 5.15 | 0.183  | 0.193 | 0.203 |
| E1   | 2.80        | 3.00 | 3.10 | 0.11   | 0.118 | 0.122 |
| e    |             | 0.65 |      |        | 0.026 |       |
| L    | 0.40        | 0.60 | 0.80 | 0.016  | 0.024 | 0.031 |
| L1   |             | 0.95 |      |        | 0.037 |       |
| L2   |             | 0.25 |      |        | 0.010 |       |
| k    | 0°          |      | 8°   | 0°     |       | 8°    |
| ccc  |             |      | 0.10 |        |       | 0.004 |

### 5.3 TSSOP8 package information

Figure 29. TSSOP8 package outline



Table 6. TSSOP8 package mechanical data

| Ref. | Dimensions  |      |      |        |        |       |
|------|-------------|------|------|--------|--------|-------|
|      | Millimeters |      |      | Inches |        |       |
|      | Min.        | Typ. | Max. | Min.   | Typ.   | Max.  |
| A    |             |      | 1.2  |        |        | 0.047 |
| A1   | 0.05        |      | 0.15 | 0.002  |        | 0.006 |
| A2   | 0.80        | 1.00 | 1.05 | 0.031  | 0.039  | 0.041 |
| b    | 0.19        |      | 0.30 | 0.007  |        | 0.012 |
| c    | 0.09        |      | 0.20 | 0.004  |        | 0.008 |
| D    | 2.90        | 3.00 | 3.10 | 0.114  | 0.118  | 0.122 |
| E    | 6.20        | 6.40 | 6.60 | 0.244  | 0.252  | 0.260 |
| E1   | 4.30        | 4.40 | 4.50 | 0.169  | 0.173  | 0.177 |
| e    |             | 0.65 |      |        | 0.0256 |       |
| k    | 0°          |      | 8°   | 0°     |        | 8°    |
| L    | 0.45        | 0.60 | 0.75 | 0.018  | 0.024  | 0.030 |
| L1   |             | 1    |      |        | 0.039  |       |
| aaa  |             | 0.1  |      |        | 0.004  |       |



## 6 Ordering information

Table 7. Order codes

| Order code               | Temperature range | Package      | Packing       | Marking                      |       |
|--------------------------|-------------------|--------------|---------------|------------------------------|-------|
| LM158WDT                 | -55 °C, +125 °C   | SO8          | Tape and reel | 158W                         |       |
| LM258AWDT                | -40 °C, +105 °C   |              |               | 258AW                        |       |
| LM258WDT                 |                   |              |               | 258W                         |       |
| LM258WPT                 |                   |              |               | TSSOP8                       | 258W  |
| LM258WYDT <sup>(1)</sup> |                   |              |               | SO8 (automotive grade)       | 258WY |
| LM258WYPT                |                   |              |               | TSSOP8<br>(automotive grade) | 258WY |
| LM258AWYPT               |                   |              |               |                              | K410  |
| LM358WST                 |                   | 0 °C, +70 °C |               | MiniSO8                      | K417  |
| LM358AWDT                | SO8               |              |               | 358AW                        |       |
| LM358AWPT                | TSSOP8            |              |               |                              |       |
| LM358AWST                | MiniSO8           |              |               | K418                         |       |
| LM358WDT                 | SO8               |              |               | 358W                         |       |

1. Qualification and characterization according to AEC Q100 and Q003 or equivalent, advanced screening according to AEC Q001 & Q 002 or equivalent are qualified.

## 7 Revision history

**Table 8. Document revision history**

| Date        | Revision | Changes  |
|-------------|----------|--|
| 01-Nov-2002 | 1        | First release.   |
| 01-Jul-2005 | 2        | ESD protection inserted in <i>Table 1: Absolute maximum ratings on page 4</i> .  |
| 06-Oct-2006 | 3        | ESD tolerance for model HBM improved to 2kV in <i>Table 1: Absolute maximum ratings on page 4</i> .<br>R <sub>thja</sub> and R <sub>thjc</sub> typical values added in <i>Table 1: Absolute maximum ratings on page 4</i> .<br>Added <i>Figure 17: Phase margin vs. capacitive load on page 10</i> .   |
| 02-Jan-2007 | 4        | Order codes added (automotive grade level) to <i>Section 6: Ordering information</i> .   |
| 15-Mar-2007 | 5        | Previously called revision 4.<br>Footnote for automotive grade order codes added to <i>Section 6: Ordering information</i> .   |
| 25-Apr-2007 | 6        | Added missing Revision 4 of January 2007 in revision history.<br>Corrected revision number of March 2007 to Revision 5.  |
| 11-Feb-2008 | 7        | Reformatted electrical characteristics table.<br>Reformatted package information.<br>Corrected MiniSO8 package information.<br>Corrected operating temperature range for automotive grade parts.   |
| 26-Aug-2008 | 8        | Corrected ESD values in <i>Table 1: Absolute maximum ratings</i> .<br>Added limitations on input current in <i>Table 1: Absolute maximum ratings</i> .<br>Corrected title for <i>Figure 11</i> .<br>Added E and L1 parameters in <i>Table 4: SO8 package mechanical data</i> .<br>Added automotive grade products for MSO8 package in <i>Table 7: Order codes</i> .                                |
| 03-Jul-2012 | 9        | Automotive grade level updated in <i>Table 7: Order codes</i> .<br>Removed order codes: LM358WYD, LM358AWYD, LM258WYD, LM258AWYD.  |
| 09-Jan-2013 | 10       | Small text changes in <i>Features and Description</i> .<br><i>Figure 1: Schematic diagram (1/2 LM158W/LM258W/LM358W)</i> : replaced.<br><i>Table 7: Order codes</i> : added order codes LM358WST and LM358AWST.  |
| 15-Jul-2013 | 11       | <i>Table 3</i> : replaced DV <sub>io</sub> with $\Delta V_{io}/\Delta T$ and DI <sub>io</sub> with $\Delta I_{io}/\Delta T$<br><i>Table 7: Order codes</i> : removed the following order codes: LM158WN, LM158WD, LM258AWYST, LM258WAN, LM258WAD, LM258WD, LM258WYST, LM358WN, LM358WD, LM358AWD, LM358WDT, LM358AWDT, LM358WPT, LM358AWPT, LM358WYDT, LM358AWYDT, LM358AWYPT; updated footnote 1. |

Table 8. Document revision history

| Date        | Revision | Changes   |
|-------------|----------|---|
| 18-Sep-2014 | 12       | Removed DIP8 package<br><i>Table 7: Order codes:</i> removed the order codes LM258WN, LM258AWYDT, LM258AWPT, LM358AWYST, LM358WYST, and LM358WYPT; added the order codes LM258WYDT, LM358AWDT, LM358AWPT, and LM358WDT. |
| 06-May-2015 | 13       | <i>Section 5: Package information:</i> replaced “package mechanical drawing” with “package outline”.<br><i>Table 7: Order codes:</i> removed “tube” packaging from all products   |
| 31-Jul-2019 | 14       | Updated <a href="#">Table 7: Order codes</a> .  |

**IMPORTANT NOTICE – PLEASE READ CAREFULLY**

STMicroelectronics NV and its subsidiaries ("ST") reserve the right to make changes, corrections, enhancements, modifications, and improvements to ST products and/or to this document at any time without notice. Purchasers should obtain the latest relevant information on ST products before placing orders. ST products are sold pursuant to ST's terms and conditions of sale in place at the time of order acknowledgement.

Purchasers are solely responsible for the choice, selection, and use of ST products and ST assumes no liability for application assistance or the design of Purchasers' products.

No license, express or implied, to any intellectual property right is granted by ST herein.

Resale of ST products with provisions different from the information set forth herein shall void any warranty granted by ST for such product.

ST and the ST logo are trademarks of ST. For additional information about ST trademarks, please refer to [www.st.com/trademarks](http://www.st.com/trademarks). All other product or service names are the property of their respective owners.

Information in this document supersedes and replaces information previously supplied in any prior versions of this document.

© 2019 STMicroelectronics – All rights reserved



Компания «ЭлектроПласт» предлагает заключение долгосрочных отношений при поставках импортных электронных компонентов на взаимовыгодных условиях!

Наши преимущества:

- Оперативные поставки широкого спектра электронных компонентов отечественного и импортного производства напрямую от производителей и с крупнейших мировых складов;
- Поставка более 17-ти миллионов наименований электронных компонентов;
- Поставка сложных, дефицитных, либо снятых с производства позиций;
- Оперативные сроки поставки под заказ (от 5 рабочих дней);
- Экспресс доставка в любую точку России;
- Техническая поддержка проекта, помощь в подборе аналогов, поставка прототипов;
- Система менеджмента качества сертифицирована по Международному стандарту ISO 9001;
- Лицензия ФСБ на осуществление работ с использованием сведений, составляющих государственную тайну;
- Поставка специализированных компонентов (Xilinx, Altera, Analog Devices, Intersil, Interpoint, Microsemi, Aeroflex, Peregrine, Syfer, Eurofarad, Texas Instrument, Miteq, Cobham, E2V, MA-COM, Hittite, Mini-Circuits, General Dynamics и др.);

Помимо этого, одним из направлений компании «ЭлектроПласт» является направление «Источники питания». Мы предлагаем Вам помощь Конструкторского отдела:

- Подбор оптимального решения, техническое обоснование при выборе компонента;
- Подбор аналогов;
- Консультации по применению компонента;
- Поставка образцов и прототипов;
- Техническая поддержка проекта;
- Защита от снятия компонента с производства.



#### Как с нами связаться

**Телефон:** 8 (812) 309 58 32 (многоканальный)

**Факс:** 8 (812) 320-02-42

**Электронная почта:** [org@eplast1.ru](mailto:org@eplast1.ru)

**Адрес:** 198099, г. Санкт-Петербург, ул. Калинина, дом 2, корпус 4, литера А.