

2x2 Antenna SWITCH GaAs MMIC

■GENERAL DESCRIPTION

NJG1544HC3 is a 2x2 antenna switch IC designed for the IEEE 802.11b or 802.11g (2.4GHz band) wireless LAN application.

This device includes logic decoder function, and can be operated by 2 bits signal to control Tx/Rx and ANT1/ANT2 switching.

This switch features high isolation and low loss.

The ultra small & ultra thin USB10-C3 package is adopted.

■PACKAGE OUTLINE



NJG1544HC3

■FEATURES

- Single low voltage control +2.5~+5.5V
- Low insertion loss 0.35dB typ. @TX-ANT2, f=2.5GHz, P_{IN}=20dBm
0.50dB typ. @RX-ANT1, RX-ANT2, f=2.5GHz, P_{IN}=10dBm
- High isolation 23dB typ. @f=2.5GHz, P_{IN}=20dBm
- Handling power (TX port) 28dBm max. @f=2.5GHz, V_{DD}=2.7V
- Low current consumption 120uA typ. @f=2.5GHz
- Ultra small & ultra thin package USB10-C3 (Package size: 1.5x2.0x0.75mm)

■PIN CONFIGURATION

USB10-C3 Type
(TOP VIEW)

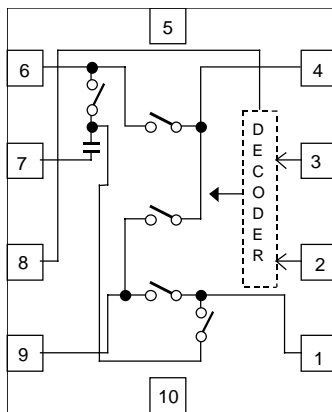

- 1 ANT1
- 2 CTL1
- 3 CTL2
- 4 ANT2
- 5 GND
- 6 TX
- 7 GND
- 8 VDD
- 9 RX
- 10 GND

■TRUTH TABLE

"H"=VCTL(H) "L"=VCTL(L)

"X"="H" or "L" (Don't care)

PASS	CONTROL SIGNAL	
	CTL1	CTL2
RX-ANT2	L	L
RX-ANT1	L	H
TX-ANT2	H	X

NJG1544HC3

■ABSOLUTE MAXIMUM RATINGS

PARAMETER	SYMBOL	CONDITIONS	RATINGS	UNITS
Input Power	P_{in}	TX, ANT2 Terminal, $V_{DD}=2.7V$, $V_{CTL}=0/2.7V$	30	dBm
		RX, ANT1 Terminal, $V_{DD}=2.7V$, $V_{CTL}=0/2.7V$	25	dBm
Supply Voltage	V_{DD}	V_{DD} Terminal	7.5	V
Control Voltage	V_{CTL}	CTL1, CTL2 Terminal	7.5	V
Power Dissipation	P_D	At on PCB board	135	mW
Operating Temp.	T_{opr}		-40~+85	°C
Storage Temp.	T_{stg}		-55~+125	°C

■ELECTRICAL CHARACTERISTICS

General conditions: $V_{DD}=2.7V$, $V_{CTL}=0/2.7V$, $Z_S=Z_I=50\Omega$, $T_a=25^\circ C$

Tested on PCB circuit as shown below.

Insertion loss of each connectors, striplines, and capacitors are excluded.

PARAMETERS	SYMBOL	CONDITIONS	MIN	TYP	MAX	UNITS
Supply voltage	VDD		2.5	2.7	5.5	V
Operating current	IDD	f=2.5GHz	-	120	150	uA
Control voltage (LOW)	$V_{CTL(L)}$		0	-	0.8	V
Control voltage (HIGH)	$V_{CTL(H)}$		2.0	-	VDD	V
Control current	I_{CTL}	f=2.5GHz	-	30	40	uA
Insertion loss 1	LOSS1	TX-ANT2, f=2.5GHz, $P_{IN}=20dBm$	-	0.35	0.65	dB
Insertion loss 2	LOSS2	RX-ANT1, RX-ANT2, f=2.5GHz, $P_{IN}=10dBm$	-	0.5	0.8	dB
Isolation 1	ISL1	TX-ANT2, f=2.5GHz, $P_{in}=20dBm$	20	23	-	dB
Isolation 2	ISL2	RX-ANT1, RX-ANT2, f=2.5GHz, $P_{in}=10dBm$	20	23	-	dB
Pin at 1dB compression point	P_{-1dB}	TX-ANT2, f=2.5GHz	26	28	-	dBm
VSWR	VSWR	f=0.1~2.5GHz, ON State	-	1.1	1.3	
Switching time	T_{SW}	f=0.1~2.5GHz	-	200	300	ns

■ TERMINAL INFORMATION

No.	SYMBOL	DESCRIPTION
1	ANT1	RF receiving port. An external capacitor of around 56pF is required to block DC voltage (V_{DD}).
2	CTL1	Control voltage input terminal. This terminal is set to High-Level (+2V~ V_{DD}) or Low-Level (0~+0.8V).
3	CTL2	Control voltage input terminal. This terminal is set to High-Level (+2V~ V_{DD}) or Low-Level (0~+0.8V).
4	ANT2	RF transmitting/receiving port. An external capacitor of 56pF is required to block DC voltage (V_{DD}).
5	GND	Ground terminal. Please connect this terminal with ground plane as close as possible for excellent RF performance.
6	TX	RF transmitting port. An external capacitor of around 56pF is required to block DC voltage (V_{DD}).
7	GND	Ground terminal. Please connect this terminal with ground plane as close as possible for excellent RF performance.
8	VDD	Positive voltage supply terminal. The positive voltage (+2.5~+5.5V) have to be supplied. Please connect a bypass capacitor with GND terminal for excellent RF performance.
9	RX	RF receiving port. An external capacitor of around 56pF is required to block DC voltage (V_{DD}).
10	GND	Ground terminal. Please connect this terminal with ground plane as close as possible for excellent RF performance.

NJG1544HC3

■ ELECTRICAL CHARACTERISTICS

(f=0.1~3.0GHz, with Application circuit, Losses of external circuit are excluded)

RX-ANT2 Insertion Loss vs. Frequency

(RX-ANT2 ON, VDD=2.7V, Pin=0dBm)

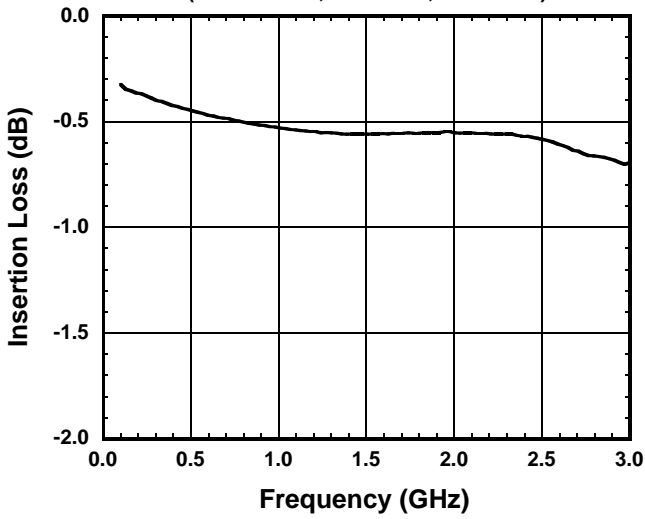

RX-ANT2 Isolation vs. Frequency

(TX-ANT2 ON, VDD=2.7V, Pin=0dBm)

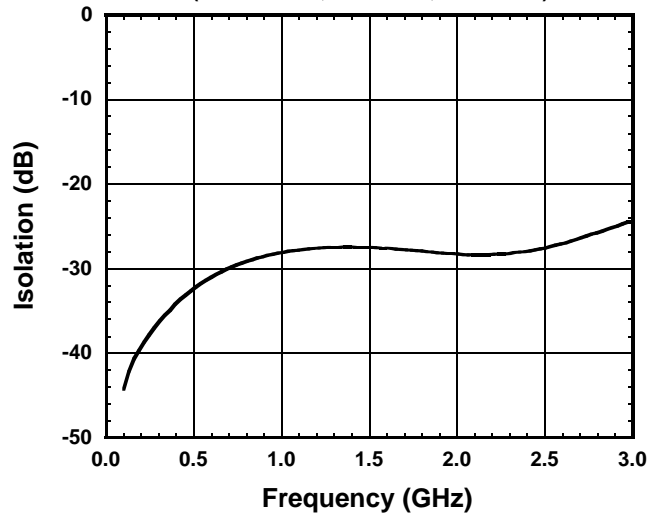

RX-ANT1 Insertion Loss vs. Frequency

(RX-ANT1 ON, VDD=2.7V, Pin=0dBm)

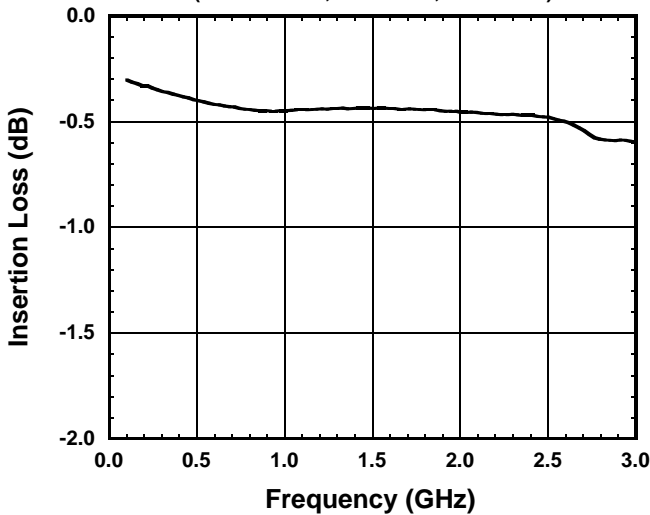

RX-ANT1 Isolation vs. Frequency

(RX-ANT2 ON, VDD=2.7V, Pin=0dBm)

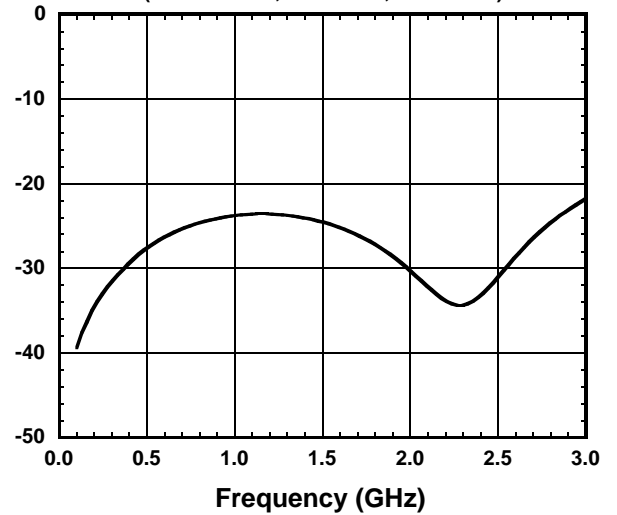

TX-ANT2 Insertion Loss vs. Frequency

(TX-ANT2 ON, VDD=2.7V, Pin=0dBm)

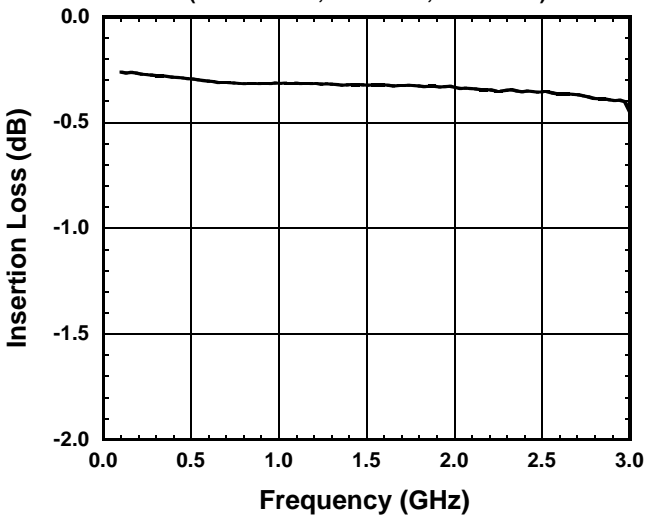

TX-ANT2 Isolation vs. frequency

(RX-ANT2 ON, VDD=2.7V, Pin=0dBm)

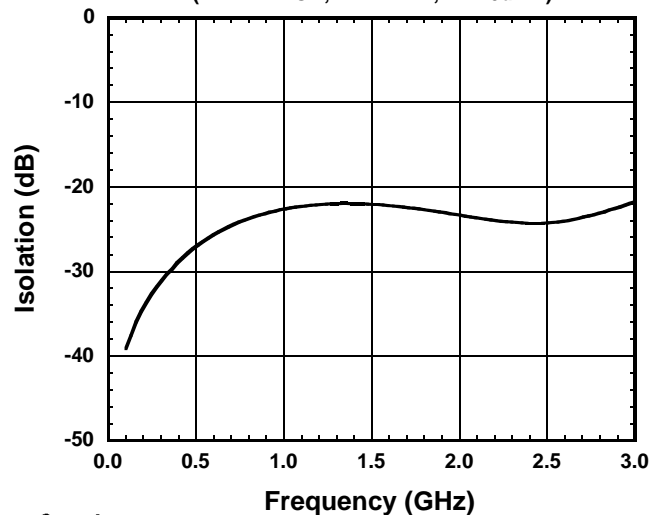

ELECTRICAL CHARACTERISTICS

(f=0.1~3.0GHz, with Application circuit, Losses of external circuit are excluded)

RX-ANT2 VSWR vs. Frequency

(RX-ANT2 ON, ANT2 port, VDD=2.7V)

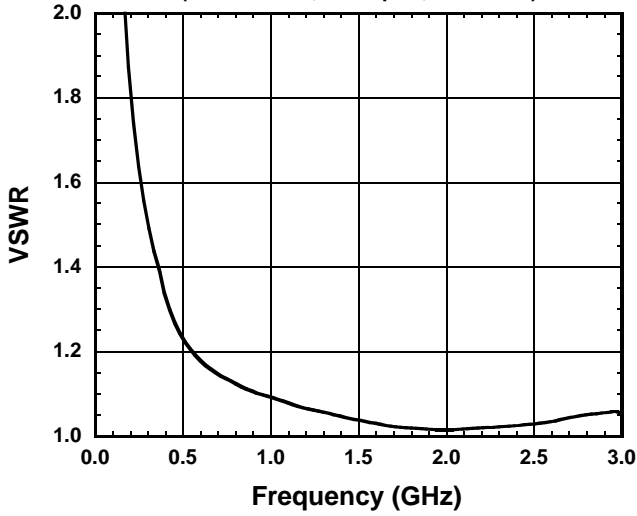

Switching Speed

(RX-ANT2 ON, VDD=2.7V)

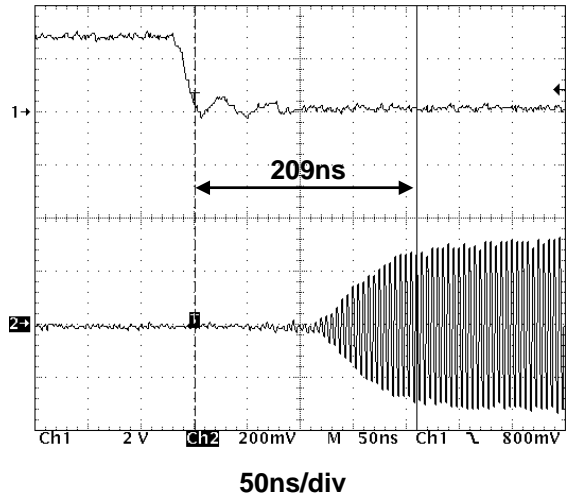

RX-ANT1 VSWR vs. Frequency

(RX-ANT1 ON, ANT1 port, VDD=2.7V)

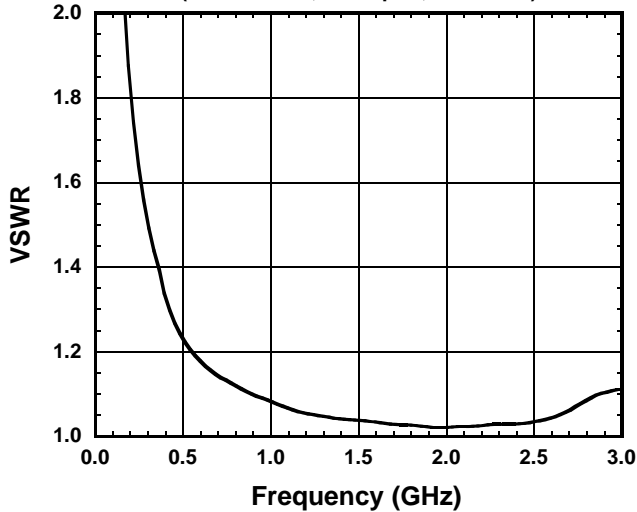

Switching Speed

(RX-ANT1 ON, VDD=2.7V)

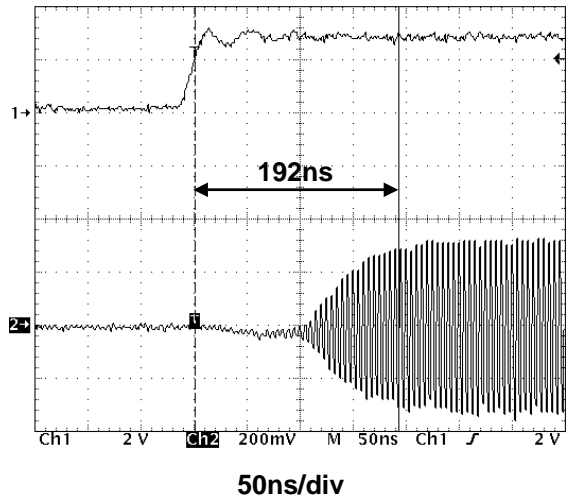

TX-ANT2 VSWR vs. Frequency

(TX-ANT2 ON, TX port, VDD=2.7V)

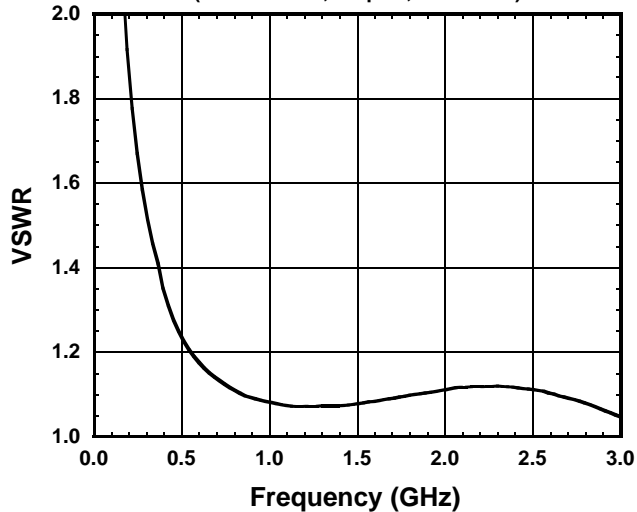

Switching Speed

(TX-ANT2 ON, VDD=2.7V)

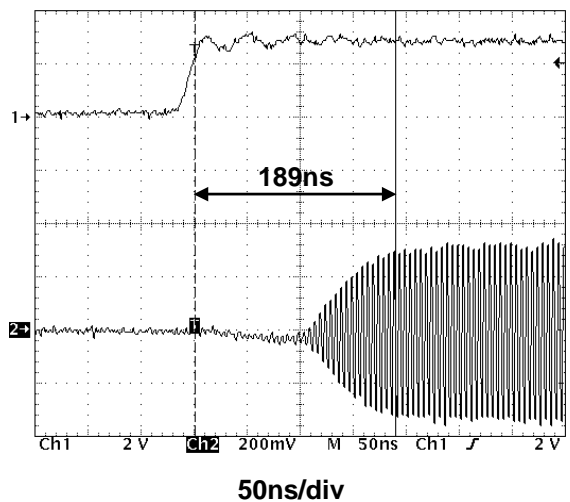

NJG1544HC3

ELECTRICAL CHARACTERISTICS

(f=0.1~3.0GHz, with Application circuit, Losses of external circuit are excluded)

Output Power, IDD vs. Input Power

(TX-ANT2 ON, fin=2.5GHz)

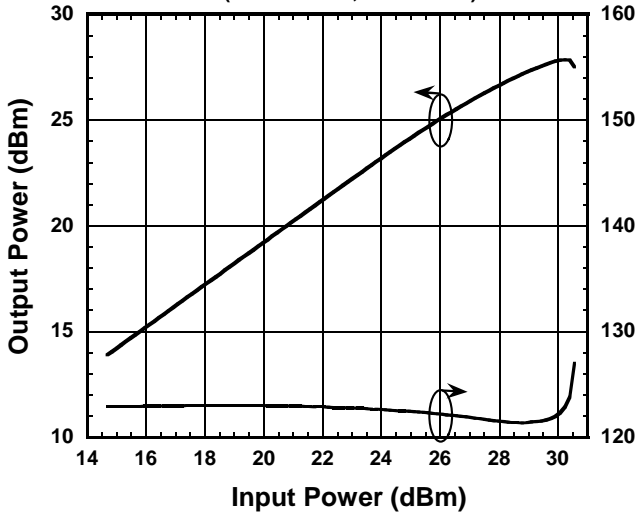

RX-ANT2 Isolation vs. Frequency

(TX-ANT2 ON, VDD=2.7V, Pin=0dBm)

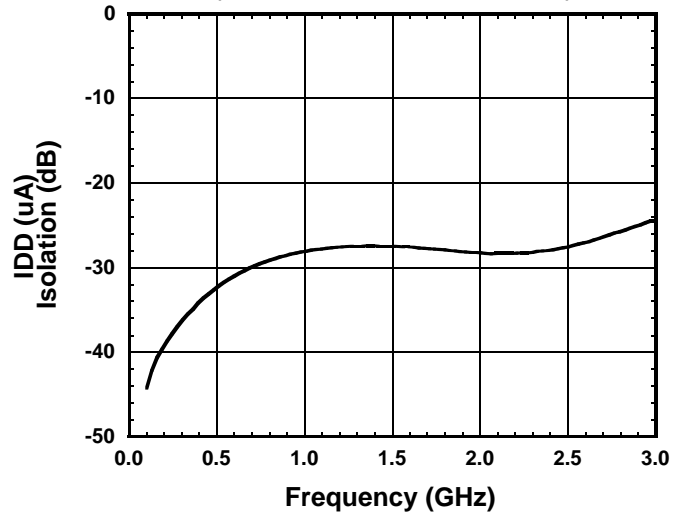

Output Power, IDD vs. Input Power

(TX-ANT2 ON, fin=960MHz)

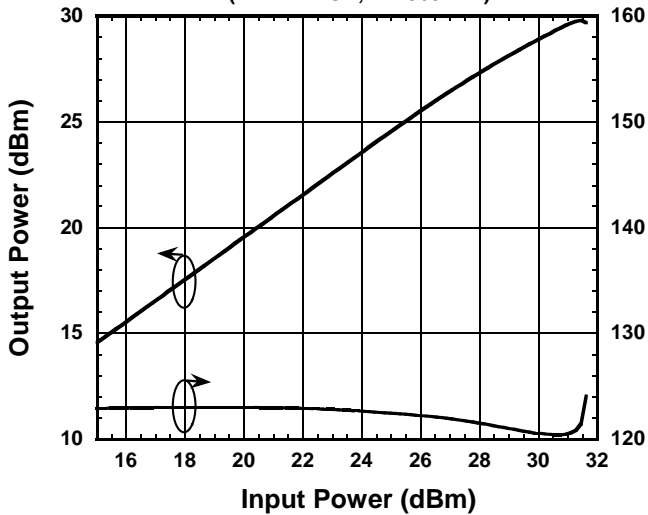

Insertion Loss vs. Input Power

(TX-ANT2 ON, fin=960MHz)

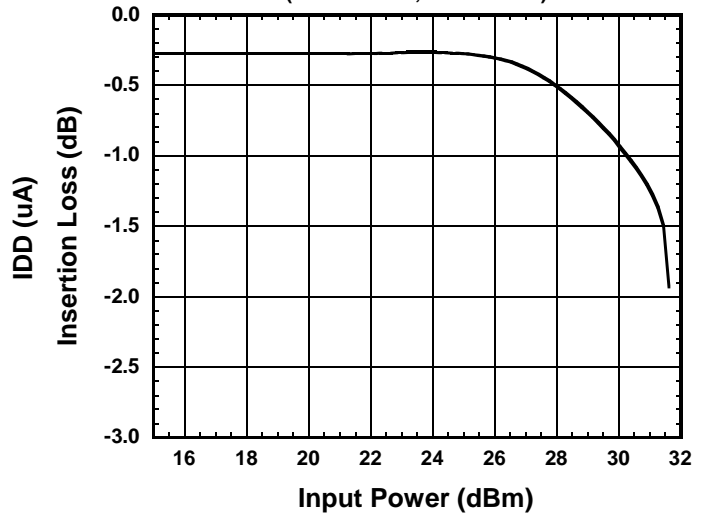

Output Power, IDD vs. Input Power

(TX-ANT2 ON, fin=2.5GHz)

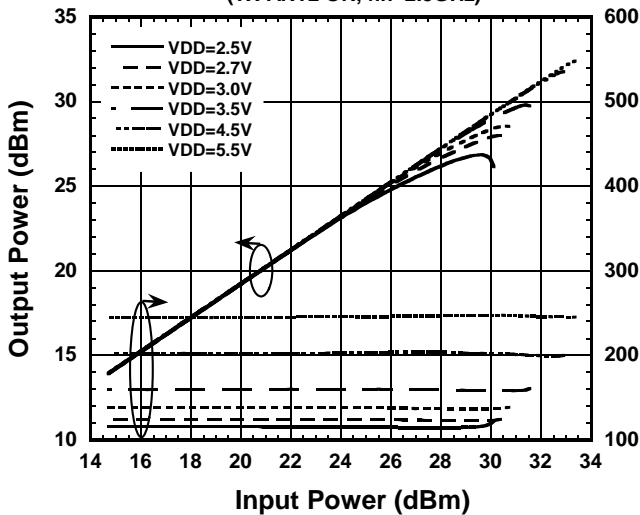

Insertion Loss vs. Input Power

(TX-ANT2 ON, fin=2.5GHz)

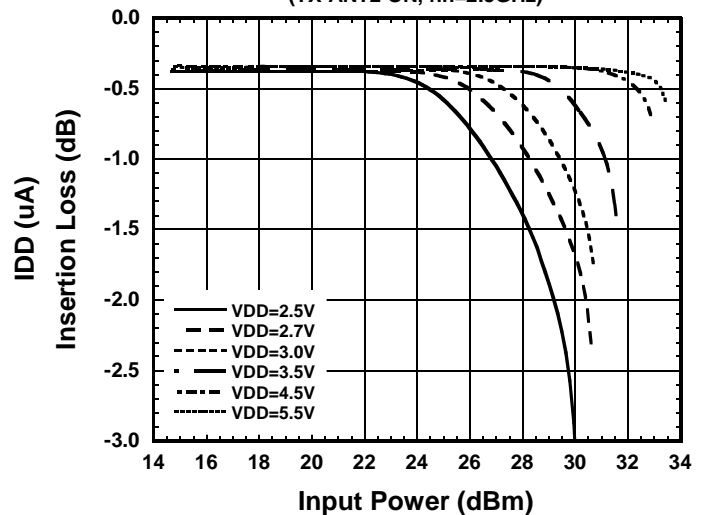

APPLICATION CIRCUIT

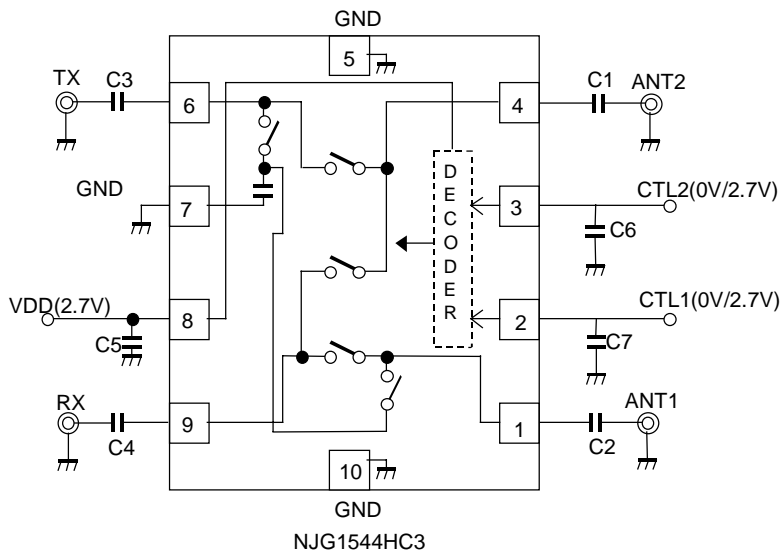

Parts List

Parts number	List 1	Notes
C1~C4	56pF	GRM36 MURATA
C5~C7	10pF	GRM36 MURATA

RECOMMENDED PCB DESIGN

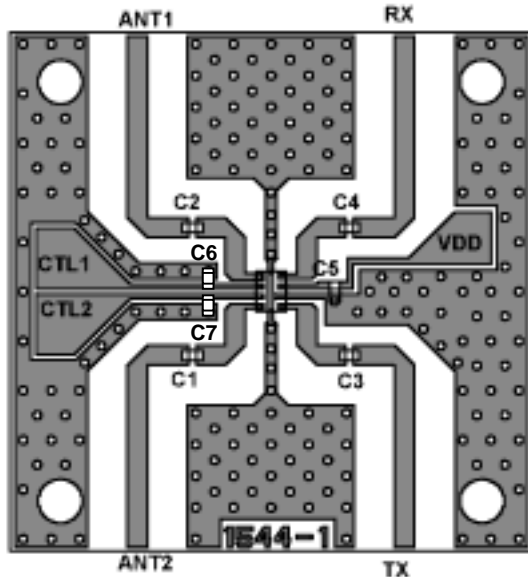

PCB SIZE=26x26 mm
 PCB:FR4 t=0.5mm
 CAPACITOR: size 1005
 Microstrip Line Width=1.0mm
 ($Z_0=50\text{ohm}$)

PRECAUTIONS

- [1] The DC blocking capacitors have to be placed at RF terminal of Tx, Rx, ANT1 and ANT2.
Please choose appropriate capacitance values to the application frequency.
- [2] To reduce stipline influence on RF characteristics, please locate bypass capacitors (C5) close to VDD terminals.
- [3] For good isolation, the GND terminal (7th pin) must be placed possibly close to ground plane of substrate, and through holes for GND should be placed near by the pin connection.

NJG1544HC3

PACKAGE OUTLINE (USB10-C3)

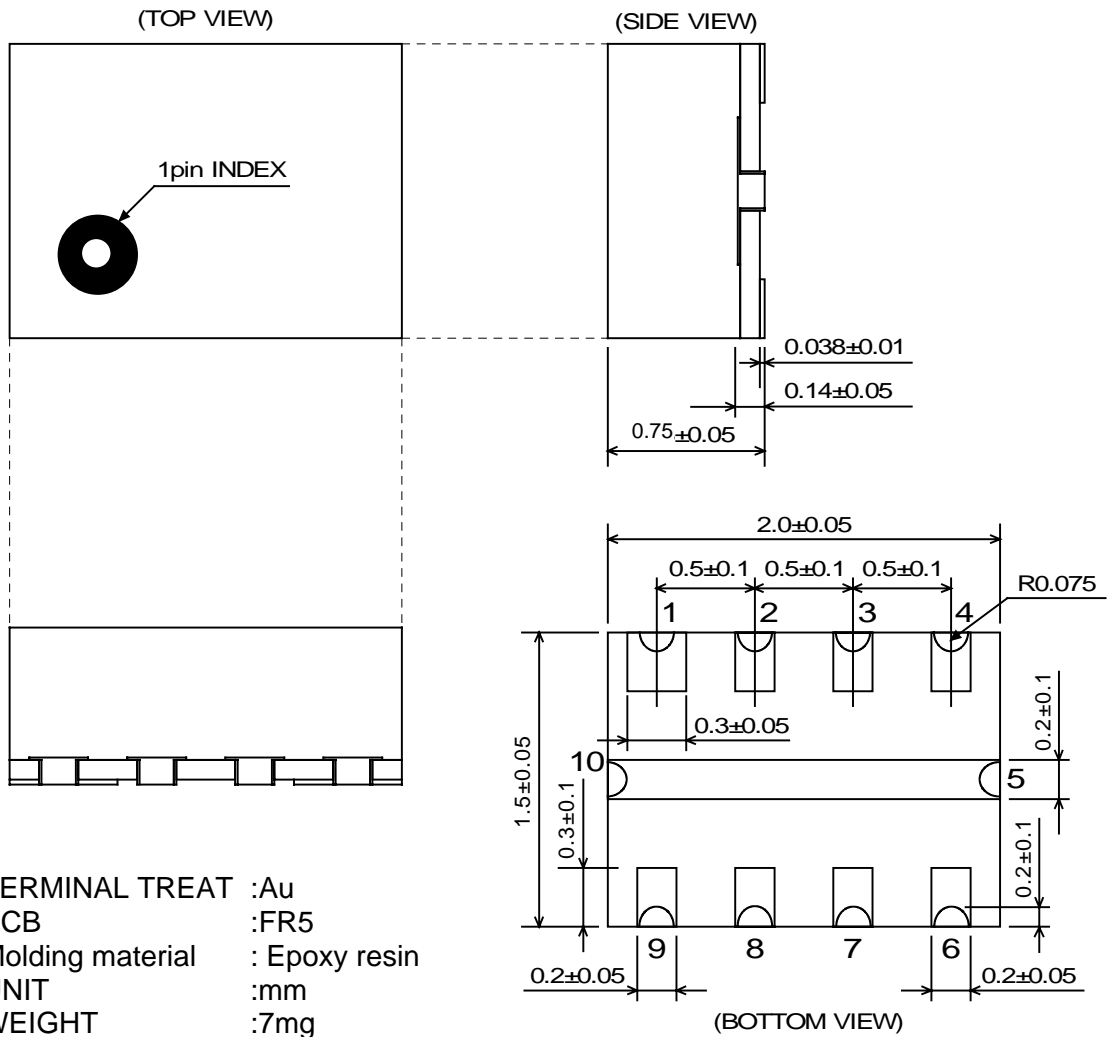

Cautions on using this product

This product contains Gallium-Arsenide (GaAs) which is a harmful material.

- Do NOT eat or put into mouth.
- Do NOT dispose in fire or break up this product.
- Do NOT chemically make gas or powder with this product.
- To waste this product, please obey the relating law of your country.

[CAUTION]

The specifications on this databook are only given for information, without any guarantee

as regards either mistakes or omissions. The application circuits in this databook are described only to show representative usages of the product and not intended for the guarantee or permission of any right including

This product may be damaged with electric static discharge (ESD) or spike voltage. Please handle with care to avoid these damages.



Компания «ЭлектроПласт» предлагает заключение долгосрочных отношений при поставках импортных электронных компонентов на взаимовыгодных условиях!

Наши преимущества:

- Оперативные поставки широкого спектра электронных компонентов отечественного и импортного производства напрямую от производителей и с крупнейших мировых складов;
- Поставка более 17-ти миллионов наименований электронных компонентов;
- Поставка сложных, дефицитных, либо снятых с производства позиций;
- Оперативные сроки поставки под заказ (от 5 рабочих дней);
- Экспресс доставка в любую точку России;
- Техническая поддержка проекта, помощь в подборе аналогов, поставка прототипов;
- Система менеджмента качества сертифицирована по Международному стандарту ISO 9001;
- Лицензия ФСБ на осуществление работ с использованием сведений, составляющих государственную тайну;
- Поставка специализированных компонентов (Xilinx, Altera, Analog Devices, Intersil, Interpoint, Microsemi, Aeroflex, Peregrine, Syfer, Eurofarad, Texas Instrument, Miteq, Cobham, E2V, MA-COM, Hittite, Mini-Circuits, General Dynamics и др.);

Помимо этого, одним из направлений компании «ЭлектроПласт» является направление «Источники питания». Мы предлагаем Вам помощь Конструкторского отдела:

- Подбор оптимального решения, техническое обоснование при выборе компонента;
- Подбор аналогов;
- Консультации по применению компонента;
- Поставка образцов и прототипов;
- Техническая поддержка проекта;
- Защита от снятия компонента с производства.



Как с нами связаться

Телефон: 8 (812) 309 58 32 (многоканальный)

Факс: 8 (812) 320-02-42

Электронная почта: org@eplast1.ru

Адрес: 198099, г. Санкт-Петербург, ул. Калинина, дом 2, корпус 4, литера А.