



2SA1552/2SC4027 — High-Voltage Switching Applications

PNP/NPN Epitaxial Planar Silicon Transistor

Applications

- Converters, inverters, color TV audio output

Features

- Adoption of FBET, MBIT processes
- High voltage and large current capacity
- Ultrahigh-speed switching
- Small and slim package permitting 2SA1552 / 2SC4027-applied sets to be made more compact

Specifications () : 2SA1552

Absolute Maximum Ratings at Ta=25°C

Parameter	Symbol	Conditions	Ratings	Unit
Collector-to-Base Voltage	V _{CB0}		(-)180	V
Collector-to-Emitter Voltage	V _{CEO}		(-)160	V
Emitter-to-Base Voltage	V _{EB0}		(-)6	V
Collector Current	I _C		(-)1.5	A
Collector Current (Pulse)	I _{CP}		(-)2.5	A

Continued on next page.

Package Dimensions unit : mm (typ)

7518-003

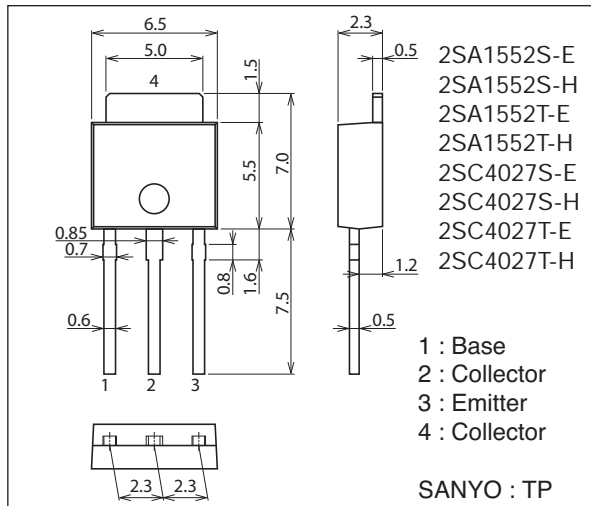

Package Dimensions unit : mm (typ)

7003-003

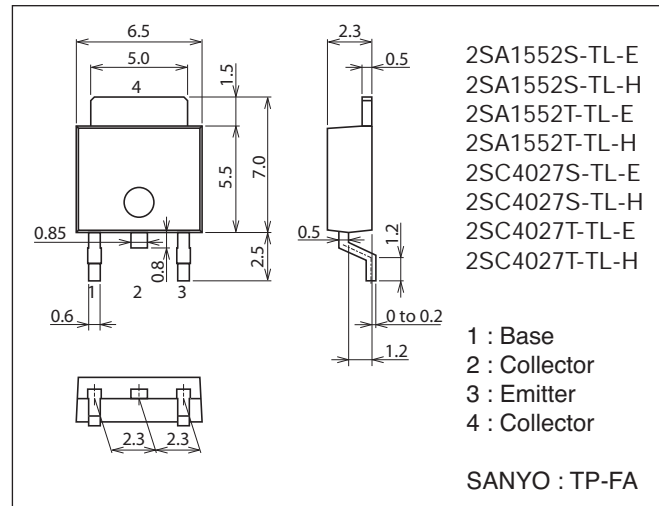

Product & Package Information

- Package : TP
- JEITA, JEDEC : SC-64, TO-251
- Minimum Packing Quantity : 500 pcs./bag

- Package : TP-FA
- JEITA, JEDEC : SC-63, TO-252
- Minimum Packing Quantity : 700 pcs./reel

Marking (TP, TP-FA)

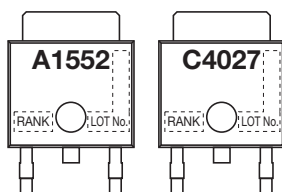

Packing Type (TP-FA) : TL

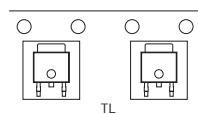

Electrical Connection

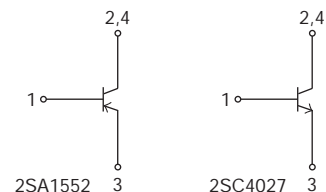

2SA1552/2SC4027

Continued from preceding page.

Parameter	Symbol	Conditions	Ratings	Unit
Collector Dissipation	P _C		1	W
		T _C =25°C	15	W
Junction Temperature	T _J		150	°C
Storage Temperature	T _{stg}		-55 to +150	°C

Electrical Characteristics at T_a=25°C

Parameter	Symbol	Conditions	Ratings			Unit
			min	typ	max	
Collector Cutoff Current	I _{CBO}	V _{CB} =(-)120V, I _E =0A			(-)1.0	μA
Emitter Cutoff Current	I _{EBO}	V _{EB} =(-)4V, I _C =0A			(-)1.0	μA
DC Current Gain	h _{FE1}	V _{CE} =(-)5V, I _C =(-)100mA	100*		400*	
	h _{FE2}	V _{CE} =(-)5V, I _C =(-)10mA	80			
Gain-Bandwidth Product	f _T	V _{CE} =(-)10V, I _C =(-)50mA		120		MHz
Output Capacitance	C _{ob}	V _{CB} =(-)10V, f=1MHz		(22)12		pF
Collector-to-Emitter Saturation Voltage	V _{CE(sat)}	I _C =(-)500mA, I _B =(-)50mA		(-0.2)0.13	(-0.5)0.45	V
Base-to-Emitter Saturation Voltage	V _{BE(sat)}	I _C =(-)500mA, I _B =(-)50mA		(-)0.85	(-)1.2	V
Collector-to-Base Breakdown Voltage	V(BR)CBO	I _C =(-)10μA, I _E =0A	(-)180			V
Collector-to-Emitter Breakdown Voltage	V(BR)CEO	I _C =(-)1mA, R _{BE} =∞	(-)160			V
Emitter-to-Base Breakdown Voltage	V(BR)EBO	I _E =(-)10μA, I _C =0A	(-)6			V
Turn-On Time	t _{on}	See specified Test Circuit.		60		ns
Storage Time	t _{stg}			(0.7)1.2		μs
Fall Time	t _f			(50)80		ns

* : The 2SA1552 / 2SC4027 are classified by 100mA h_{FE} as follows : (unit : μA)

Rank	R	S	T
h _{FE}	100 to 200	140 to 280	200 to 400

Switching Time Test Circuit

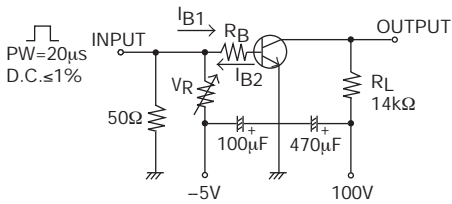

$$10I_{B1} = -10I_{B2} = I_C = 0.7A$$

For PNP, the polarity is reversed.

Ordering Information

Device	Package	Shipping	memo
2SA1552S-E	TP	500pcs./bag	Pb Free
2SA1552S-H	TP	500pcs./bag	Pb Free and Halogen Free
2SA1552T-E	TP	500pcs./bag	Pb Free
2SA1552T-H	TP	500pcs./bag	Pb Free and Halogen Free
2SC4027S-E	TP	500pcs./bag	Pb Free
2SC4027S-H	TP	500pcs./bag	Pb Free and Halogen Free
2SC4027T-E	TP	500pcs./bag	Pb Free
2SC4027T-H	TP	500pcs./bag	Pb Free and Halogen Free
2SA1552S-TL-E	TP-FA	700pcs./reel	Pb Free
2SA1552S-TL-H	TP-FA	700pcs./reel	Pb Free and Halogen Free
2SA1552T-TL-E	TP-FA	700pcs./reel	Pb Free
2SA1552T-TL-H	TP-FA	700pcs./reel	Pb Free and Halogen Free
2SC4027S-TL-E	TP-FA	700pcs./reel	Pb Free
2SC4027S-TL-H	TP-FA	700pcs./reel	Pb Free and Halogen Free
2SC4027T-TL-E	TP-FA	700pcs./reel	Pb Free
2SC4027T-TL-H	TP-FA	700pcs./reel	Pb Free and Halogen Free

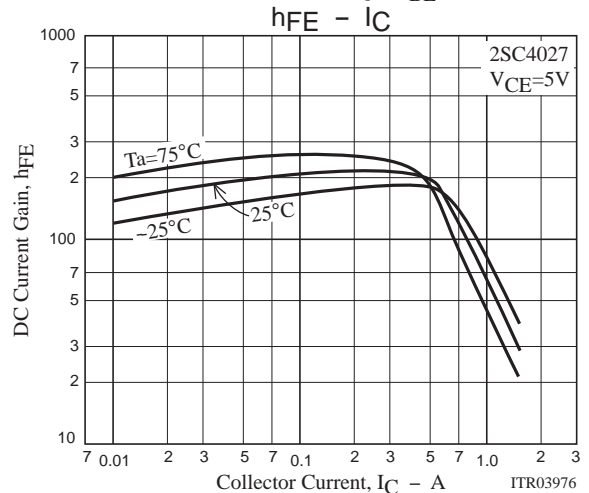
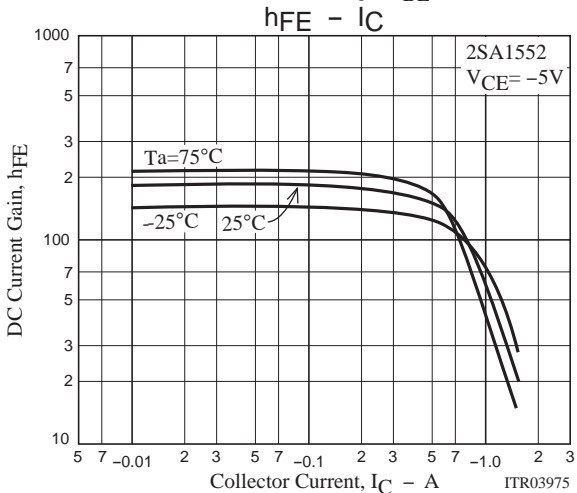
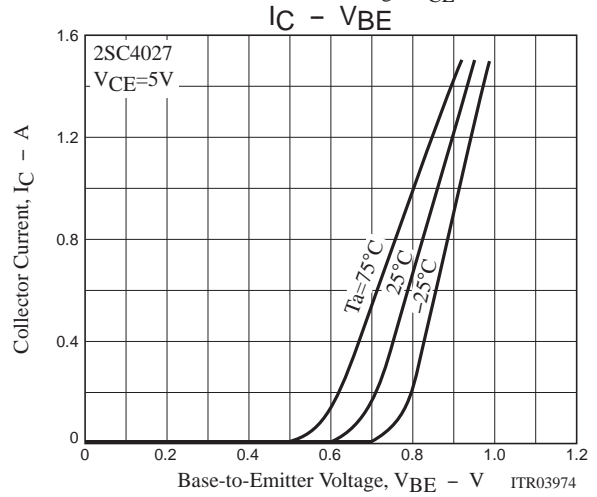
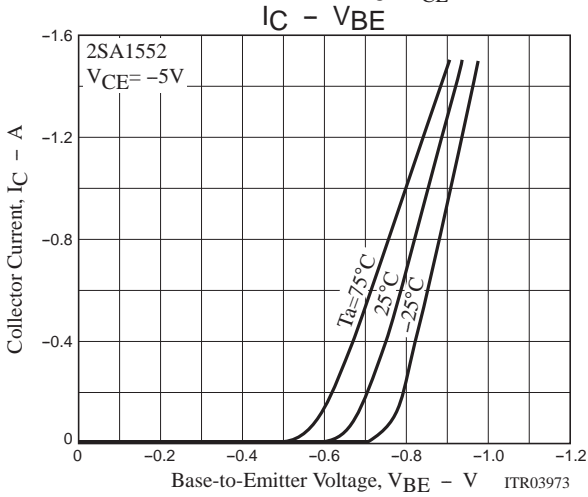
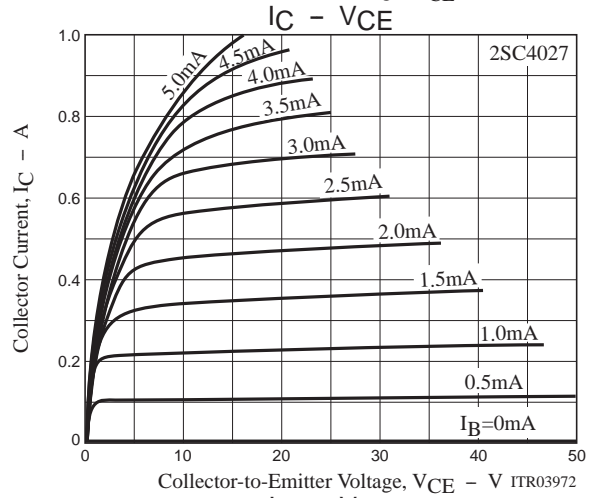
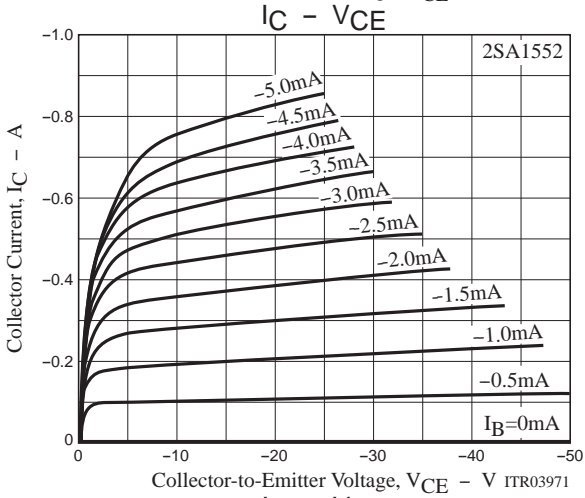
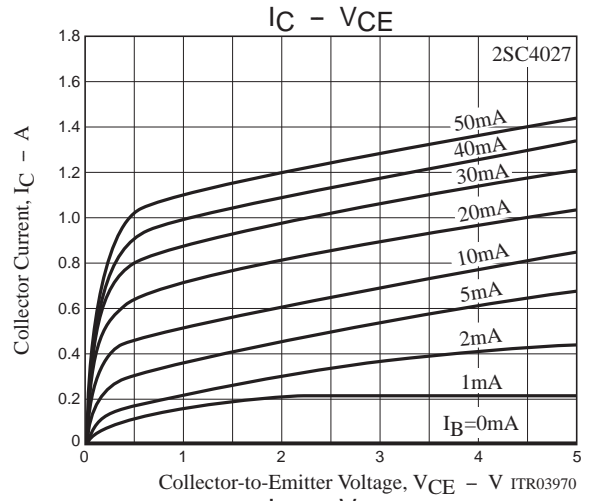
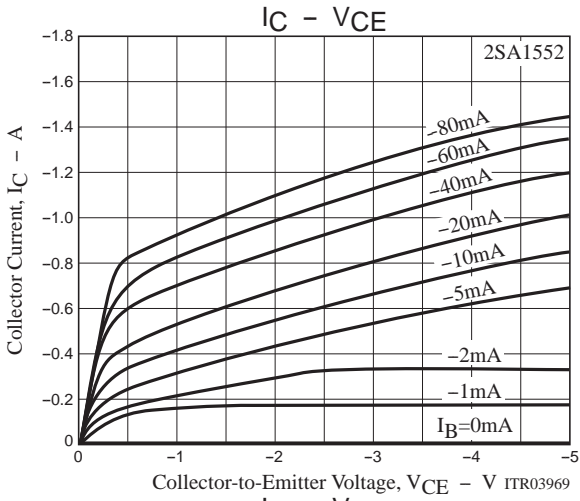

2SA1552/2SC4027

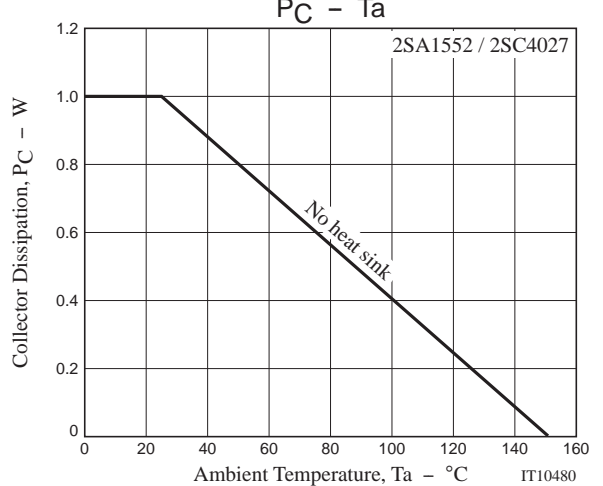
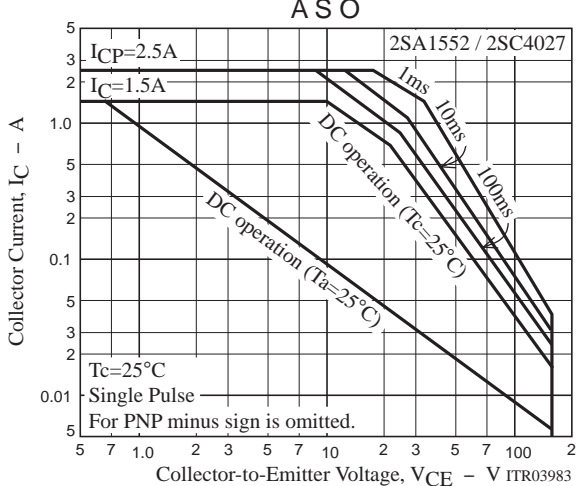
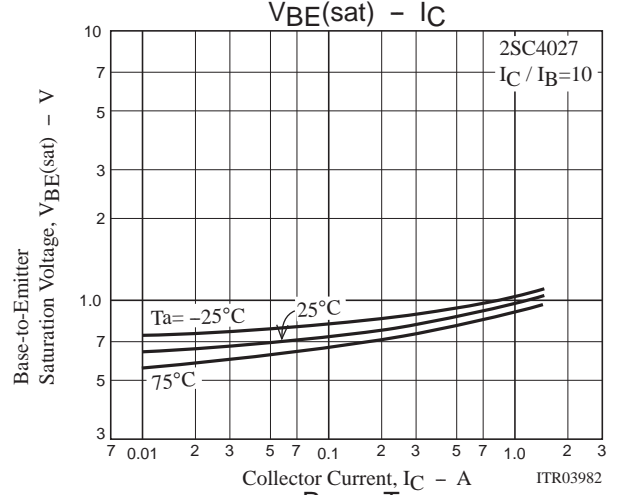
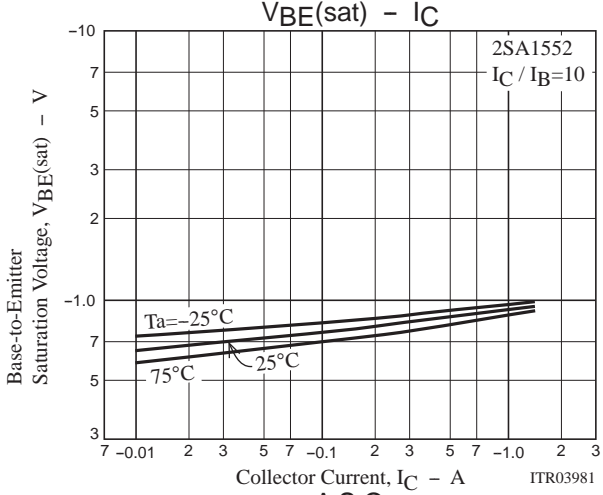
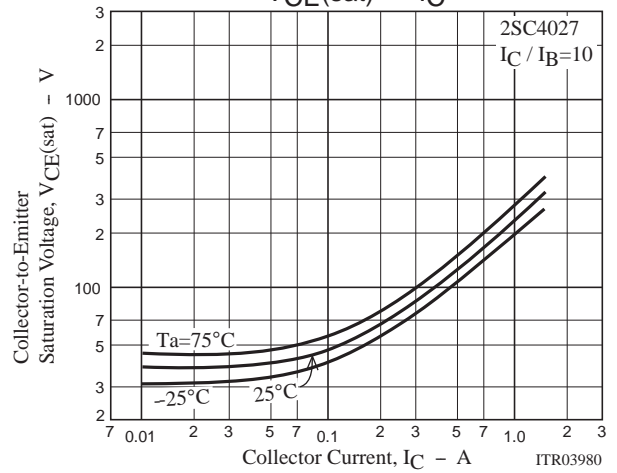
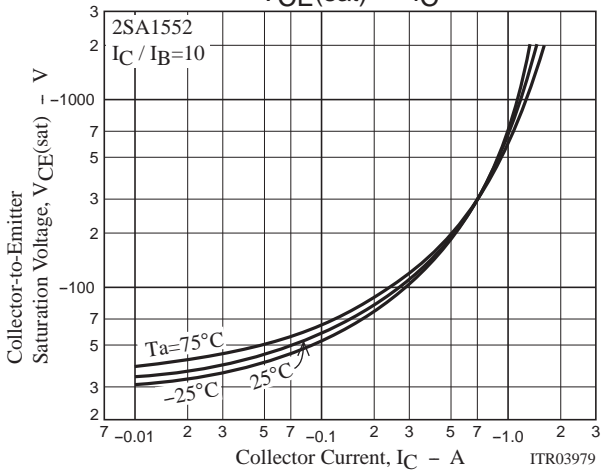

2SA1552/2SC4027

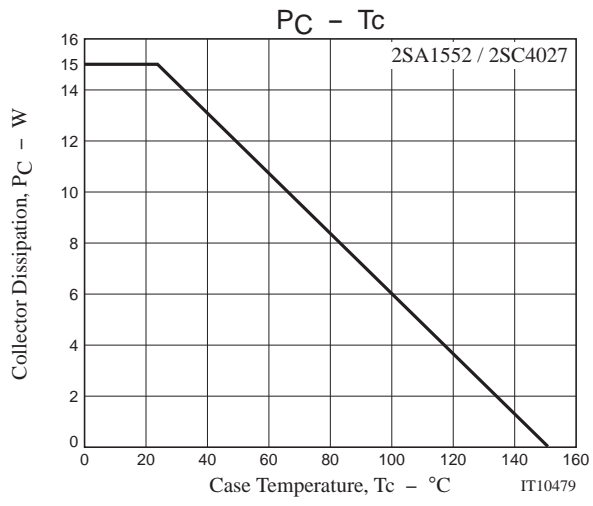

2SA1552/2SC4027

Taping Specification

2SA1552S-TL-E, 2SA1552S-TL-H, 2SA1552T-TL-E, 2SA1552T-TL-H, 2SC4027S-TL-E, 2SC4027S-TL-H, 2SC4027T-TL-E, 2SC4027T-TL-H

Packing Format

Package Name	Carrier Tape Type	Maximum Number of devices contained (pcs)			Packing format	
		Reel	Inner box	Outer box	Inner BOX (C-1)	Outer BOX (A-7)
TP-FA	TP	700	2,100	12,600	3 reels contained Dimensions:mm (external) 183×72×185	6 inner boxes contained Dimensions:mm (external) 440×195×210

Packing method

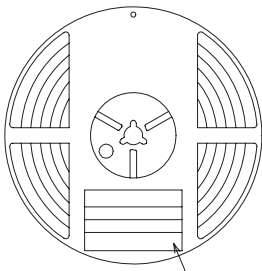

Reel label, Inner box label Outer box label

(unit: mm)

It is a label at the time of factory shipments.
The form of a label may change in physical distribution process.

Type No. →

LOT No. →

Quantity →

Origin →

69

(P) TYPE 000000000

(T) LOT 00

(Q) QTY 0,000 (1) LEAD FREE *

(S) SPECIAL

Z0722005310C

ASSEMBLY:**** (DIFFUSION:****)

43

108

TYPE CODE

TYPE ○○○○○○○○

QTY 0,000 PCS (1) LEAD FREE *

LOT ○○○○○○○○

PACKAGE ○○○○○○○○

SPECIAL

Z0722005310C

ASSEMBLY:**** (DIFFUSION:****)

80

NOTE (1)
The LEAD FREE * description shows that the surface treatment of the terminal is lead free.

Label	JEITA Phase
LEAD FREE 3	JEITA Phase 3A
LEAD FREE 4	JEITA Phase 3

Taping configuration

1. Carrier tape size (unit:mm)

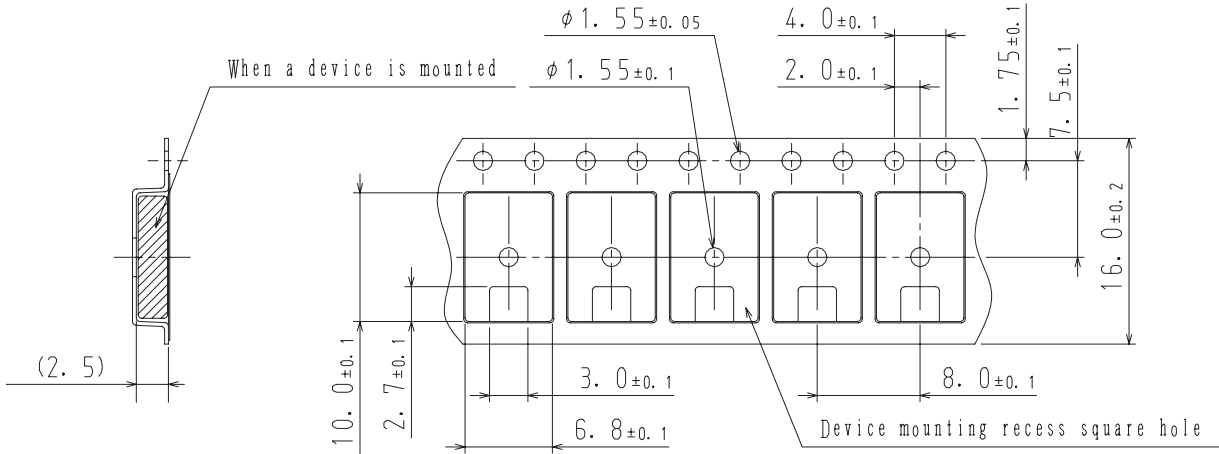

2. Device placement direction

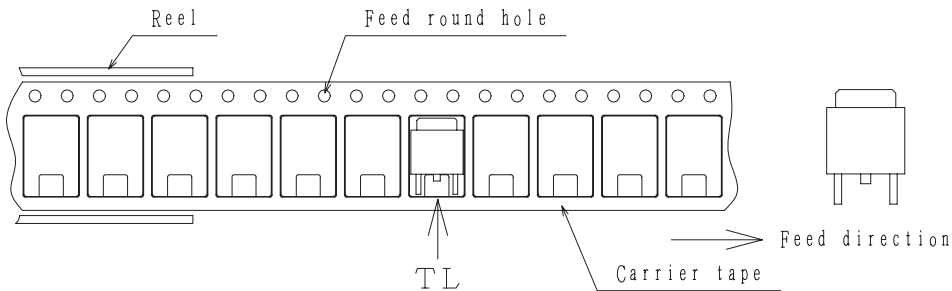

Those with one electrode terminal on the feed hole side.....TL

2SA1552/2SC4027

Outline Drawing

Land Pattern Example

2SA1552S-TL-E, 2SA1552S-TL-H, 2SA1552T-TL-E, 2SA1552T-TL-H, 2SC4027S-TL-E, 2SC4027S-TL-H, 2SC4027T-TL-E, 2SC4027T-TL-H

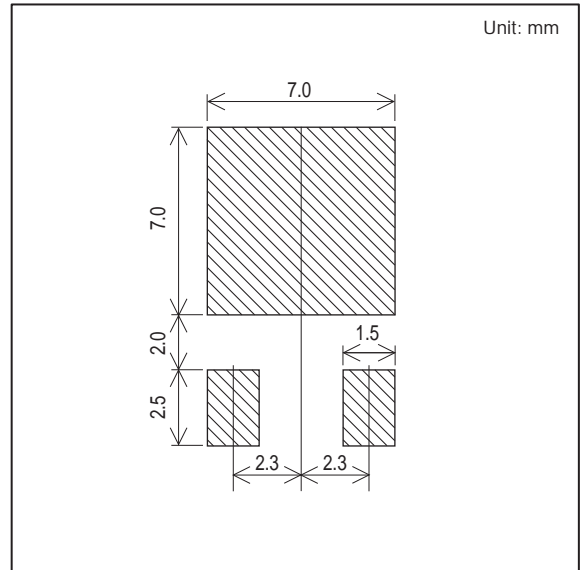
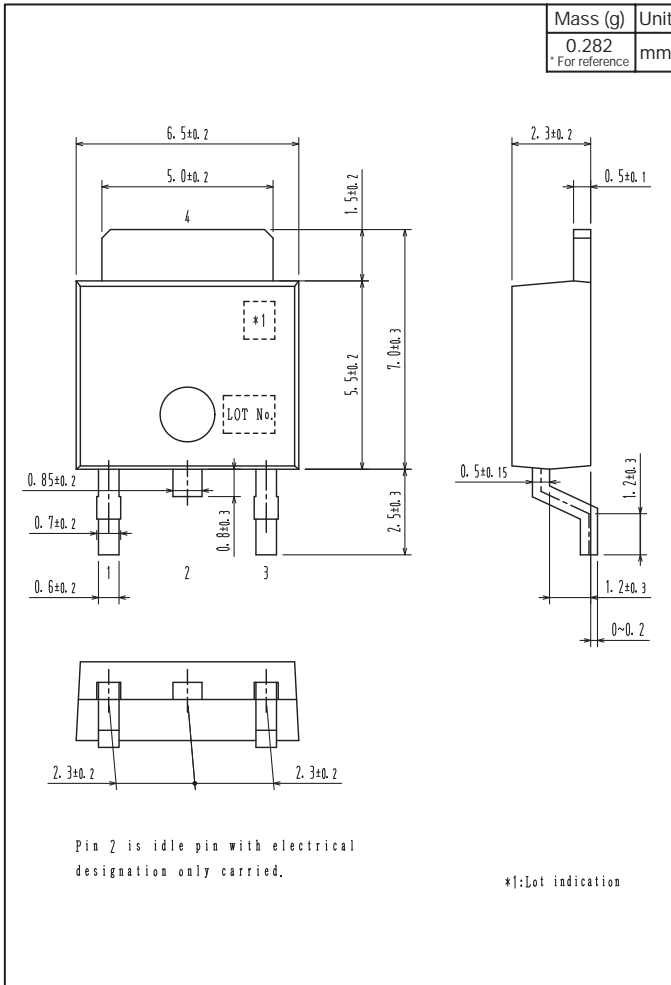

2SA1552/2SC4027

Bag Packing Specification

2SA1552S-E, 2SA1552S-H, 2SA1552T-E, 2SA1552T-H, 2SC4027S-E, 2SC4027S-H, 2SC4027T-E, 2SC4027T-H

1. Packing Format

Package Name	Maximum Number of devices contained (pcs)			
	Bag	Inner box	Outer box	
TP	500	B-1	A-1	A-2
		10,000	50,000	30,000
	Packing format (Dimensions:mm (external))			
		Inner box	Outer box	
		B-1	A-1	A-2
		445×225×55	470×250×300	470×250×190

2. Bag dimensions (unit:mm)

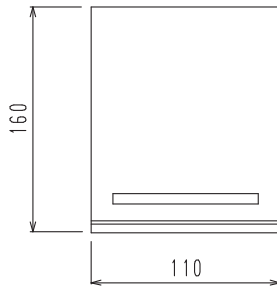

3. Bag label, Inner box label (unit:mm)

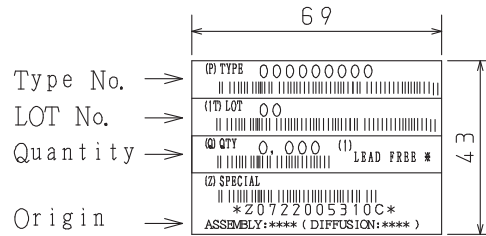

4. Outer box label (unit:mm)

It is a label at the time of factory shipments.
The form of a label may change in physical distribution process.

NOTE (1)

The LEAD FREE * description shows that the surface treatment of the terminal is lead free.

Label	JEITA Phase
LEAD FREE 3	JEITA Phase 3A
LEAD FREE 4	JEITA Phase 3

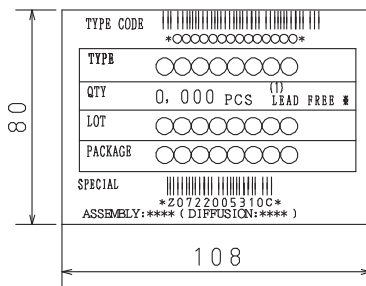

2SA1552/2SC4027

Outline Drawing

2SA1552S-E, 2SA1552S-H, 2SA1552T-E, 2SA1552T-H, 2SC4027S-E, 2SC4027S-H, 2SC4027T-E, 2SC4027T-H



- Any and all SANYO Semiconductor Co.,Ltd. products described or contained herein are, with regard to "standard application", intended for the use as general electronics equipment. The products mentioned herein shall not be intended for use for any "special application" (medical equipment whose purpose is to sustain life, aerospace instrument, nuclear control device, burning appliances, transportation machine, traffic signal system, safety equipment etc.) that shall require extremely high level of reliability and can directly threaten human lives in case of failure or malfunction of the product or may cause harm to human bodies, nor shall they grant any guarantee thereof. If you should intend to use our products for new introduction or other application different from current conditions on the usage of automotive device, communication device, office equipment, industrial equipment etc. , please consult with us about usage condition (temperature, operation time etc.) prior to the intended use. If there is no consultation or inquiry before the intended use, our customer shall be solely responsible for the use.
- Specifications of any and all SANYO Semiconductor Co.,Ltd. products described or contained herein stipulate the performance, characteristics, and functions of the described products in the independent state, and are not guarantees of the performance, characteristics, and functions of the described products as mounted in the customer's products or equipment. To verify symptoms and states that cannot be evaluated in an independent device, the customer should always evaluate and test devices mounted in the customer's products or equipment.
- SANYO Semiconductor Co.,Ltd. assumes no responsibility for equipment failures that result from using products at values that exceed, even momentarily, rated values (such as maximum ratings, operating condition ranges, or other parameters) listed in products specifications of any and all SANYO Semiconductor Co.,Ltd. products described or contained herein.
- Regarding monolithic semiconductors, if you should intend to use this IC continuously under high temperature, high current, high voltage, or drastic temperature change, even if it is used within the range of absolute maximum ratings or operating conditions, there is a possibility of decrease reliability. Please contact us for a confirmation.
- SANYO Semiconductor Co.,Ltd. strives to supply high-quality high-reliability products, however, any and all semiconductor products fail or malfunction with some probability. It is possible that these probabilistic failures or malfunction could give rise to accidents or events that could endanger human lives, trouble that could give rise to smoke or fire, or accidents that could cause damage to other property. When designing equipment, adopt safety measures so that these kinds of accidents or events cannot occur. Such measures include but are not limited to protective circuits and error prevention circuits for safe design, redundant design, and structural design.
- In the event that any or all SANYO Semiconductor Co.,Ltd. products described or contained herein are controlled under any of applicable local export control laws and regulations, such products may require the export license from the authorities concerned in accordance with the above law.
- No part of this publication may be reproduced or transmitted in any form or by any means, electronic or mechanical, including photocopying and recording, or any information storage or retrieval system, or otherwise, without the prior written consent of SANYO Semiconductor Co.,Ltd.
- Any and all information described or contained herein are subject to change without notice due to product/technology improvement, etc. When designing equipment, refer to the "Delivery Specification" for the SANYO Semiconductor Co.,Ltd. product that you intend to use.
- Upon using the technical information or products described herein, neither warranty nor license shall be granted with regard to intellectual property rights or any other rights of SANYO Semiconductor Co.,Ltd. or any third party. SANYO Semiconductor Co.,Ltd. shall not be liable for any claim or suits with regard to a third party's intellectual property rights which has resulted from the use of the technical information and products mentioned above.

This catalog provides information as of June, 2012. Specifications and information herein are subject to change without notice.



Компания «ЭлектроПласт» предлагает заключение долгосрочных отношений при поставках импортных электронных компонентов на взаимовыгодных условиях!

Наши преимущества:

- Оперативные поставки широкого спектра электронных компонентов отечественного и импортного производства напрямую от производителей и с крупнейших мировых складов;
- Поставка более 17-ти миллионов наименований электронных компонентов;
- Поставка сложных, дефицитных, либо снятых с производства позиций;
- Оперативные сроки поставки под заказ (от 5 рабочих дней);
- Экспресс доставка в любую точку России;
- Техническая поддержка проекта, помощь в подборе аналогов, поставка прототипов;
- Система менеджмента качества сертифицирована по Международному стандарту ISO 9001;
- Лицензия ФСБ на осуществление работ с использованием сведений, составляющих государственную тайну;
- Поставка специализированных компонентов (Xilinx, Altera, Analog Devices, Intersil, Interpoint, Microsemi, Aeroflex, Peregrine, Syfer, Eurofarad, Texas Instrument, Miteq, Cobham, E2V, MA-COM, Hittite, Mini-Circuits, General Dynamics и др.);

Помимо этого, одним из направлений компании «ЭлектроПласт» является направление «Источники питания». Мы предлагаем Вам помощь Конструкторского отдела:

- Подбор оптимального решения, техническое обоснование при выборе компонента;
- Подбор аналогов;
- Консультации по применению компонента;
- Поставка образцов и прототипов;
- Техническая поддержка проекта;
- Защита от снятия компонента с производства.



Как с нами связаться

Телефон: 8 (812) 309 58 32 (многоканальный)

Факс: 8 (812) 320-02-42

Электронная почта: org@eplast1.ru

Адрес: 198099, г. Санкт-Петербург, ул. Калинина, дом 2, корпус 4, литера А.