



Through Hole Lamp Product Data Sheet LTL1CHKXKNNSERIES

Spec No.: DS20-2000-343

Effective Date: 08/22/2000

Revision: -

LITE-ON DCC

RELEASE

BNS-OD-FC001/A4

LTL1CHKxKNN 45 degree

Features

- T-1(3mm) General Purpose LED Lamps.
- Low power consumption.
- High efficiency .
- Water Clear Lens Options.
- High luminous intensity output.
- I.C. Compatible/low current requirement.

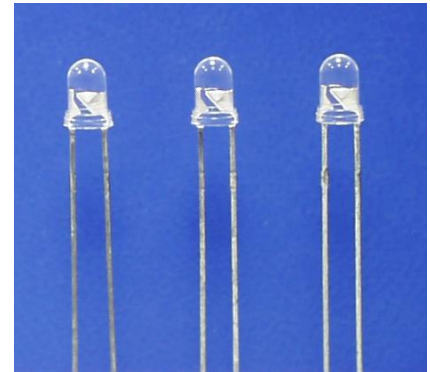
**Description**

This family 3mm LED lamps are standard designed for applications requiring higher intensity level.

The source color devices are made with Aluminum Indium Gallium Phosphide(AlInGaP) on Gallium Arsenide light emitting diode.

Application

- General Purpose.
- Indicator Lights.

Devices

Part No.	Lens	Source Color
LTL1CHKDKNN	Water Clear	AllnGap Hyper Red
LTL1CHKRKNN	Water Clear	AllnGap Super Red
LTL1CHKEKNN	Water Clear	AllnGap Red
LTL1CHKFKNN	Water Clear	AllnGap Yellow Orange
LTL1CHKYKNN	Water Clear	AllnGap Amber Yellow
LTL1CHKSKNN	Water Clear	AllnGap Yellow
LTL1CHKGKNN	Water Clear	AllnGap Green

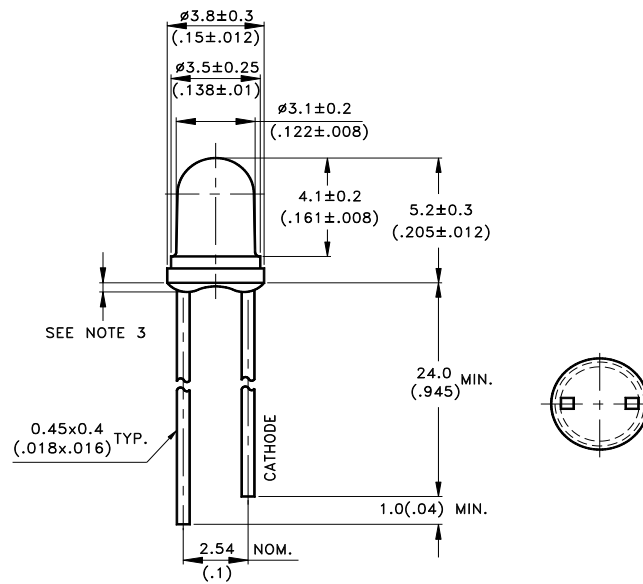
Package Dimensions**LTL1CHx Series**

Notes:

1. All dimensions are in millimeters (inches).
2. Tolerance is $\pm 0.25\text{mm}(.010\text{'})$ unless otherwise noted.
3. Protruded resin under flange is $1.0\text{mm}(.04\text{'})$ max.
4. Lead spacing is measured where the leads emerge from the package.
5. Specifications are subject to change without notice.



Absolute Maximum Ratings at TA=25°C

Parameter	Hyper Red	Super Red	Red	Yellow Orange	Amber Yellow	Yellow	Green	Unit
Power Dissipation	75	75	75	75	75	75	75	mW
Peak Forward Current (1/10 Duty Cycle, 0.1ms Pulse Width)	90	90	90	60	60	60	60	mA
Continuous Forward Current	30	30	30	30	30	30	30	mA
Derating Linear From 70°C	0.4	0.4	0.4	0.4	0.4	0.4	0.4	mA / °C
Reverse Voltage (IR =100 μ A)	5	5	5	5	5	5	5	V
Operating Temperature Range	-40°C to + 100°C							
Storage Temperature Range	-55°C to + 100°C							
Lead Soldering Temperature [1.6mm(.063") From Body]	260°C for 5 Seconds							

Electrical / Optical Characteristics at TA=25°C

Parameter	Symbol	Part No. (LTL)	Min.	Typ.	Max.	Unit	Test Condition
Luminous Intensity	I _v	1CHKDKNN	140	210		mcd	I _F = 20mA Note 1 Note 2
		1CHKRKNN	140	250			
		1CHKEKNN	140	320			
		1CHKFKNN	140	320			
		1CHKYKNN	140	320			
		1CHKSKNN	140	320			
		1CHKGKNN	140	320			
Viewing Angle	2 θ _{1/2}			45		deg	Note 3 (Fig.5)
Peak Emission Wavelength	λ _P	1CHKDKNN		650		nm	Measurement @ peak (Fig.1)
		1CHKRKNN		639			
		1CHKEKNN		632			
		1CHKFKNN		611			
		1CHKYKNN		595			
		1CHKSKNN		588			
		1CHKGKNN		575			
Dominant Wavelength	λ _d	1CHKDKNN		639		nm	Note 5
		1CHKRKNN		632			
		1CHKEKNN		624			
		1CHKFKNN		605			
		1CHKYKNN		592			
		1CHKSKNN		587			
		1CHKGKNN		572			
Spectral Line Half-Width	Δλ	1CHKDKNN		20		nm	
		1CHKRKNN		20			
		1CHKEKNN		20			
		1CHKFKNN		17			
		1CHKYKNN		15			
		1CHKSKNN		15			
		1CHKGKNN		15			
Forward Voltage	V _F	1CHKDKNN		2.0	2.4	V	I _F = 20mA
		1CHKRKNN		2.0	2.3		
		1CHKEKNN		2.05	2.4		
		1CHKFKNN		2.05	2.4		
		1CHKYKNN		2.05	2.4		
		1CHKSKNN		2.05	2.4		
		1CHKGKNN		2.05	2.4		
Reverse Current	I _R				100	μA	V _R = 5V
Capacitance	C			40		pF	V _F = 0, f = 1 MHz

NOTES:

- Luminous intensity is measured with a light sensor and filter combination that approximates the CIE eye-response curve.
- Luminous intensity rank classified products support two ranks.
- θ 1/2 is the off-axis angle at which the luminous intensity is half the axial luminous intensity.
- I_v classification code is marked on each packing bag.
- The dominant wavelength, λ_d is derived from the CIE chromaticity diagram and represents the single wavelength which defines the color of the device.

Property of Lite-On Only

Typical Electrical / Optical Characteristics Curves

(25°C Ambient Temperature Unless Otherwise Noted)

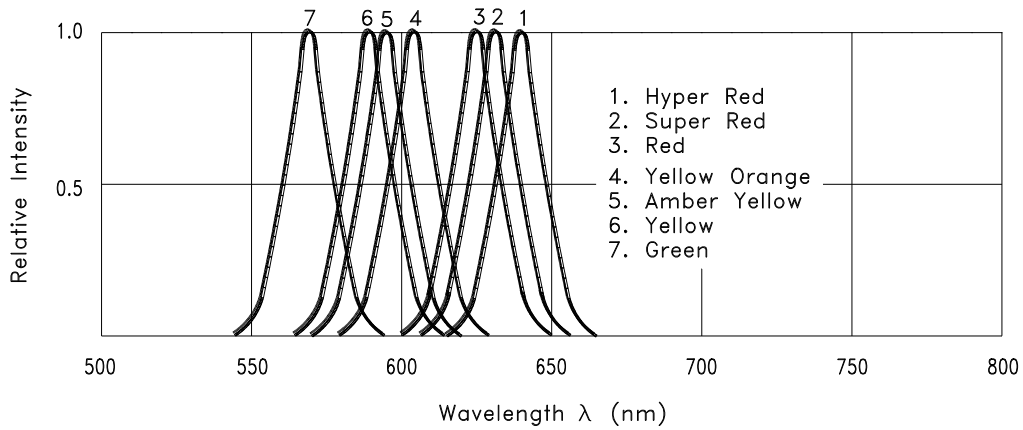

Fig.1 Relative Intensity vs. Wavelength

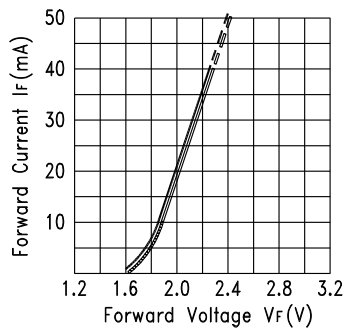

Fig.2 Forward Current vs. Forward Voltage

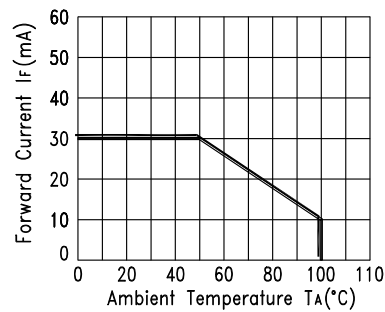

Fig.3 Forward Current Derating Curve

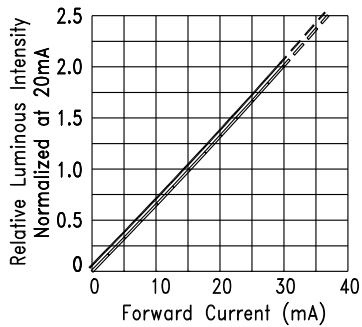

Fig.4 Relative Luminous Intensity vs. Forward Current

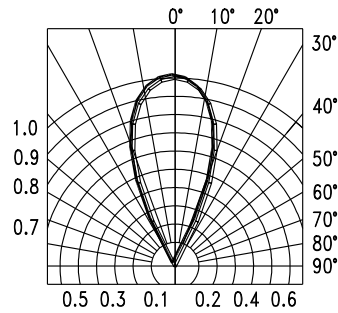

Fig.5 Spatial Distribution

Mouser Electronics

Authorized Distributor

Click to View Pricing, Inventory, Delivery & Lifecycle Information:

[Lite-On:](#)

[LTL1CHKSKNN](#) [LTL1CHKYKNN](#) [LTL1CHKGKNN](#)



Компания «ЭлектроПласт» предлагает заключение долгосрочных отношений при поставках импортных электронных компонентов на взаимовыгодных условиях!

Наши преимущества:

- Оперативные поставки широкого спектра электронных компонентов отечественного и импортного производства напрямую от производителей и с крупнейших мировых складов;
- Поставка более 17-ти миллионов наименований электронных компонентов;
- Поставка сложных, дефицитных, либо снятых с производства позиций;
- Оперативные сроки поставки под заказ (от 5 рабочих дней);
- Экспресс доставка в любую точку России;
- Техническая поддержка проекта, помощь в подборе аналогов, поставка прототипов;
- Система менеджмента качества сертифицирована по Международному стандарту ISO 9001;
- Лицензия ФСБ на осуществление работ с использованием сведений, составляющих государственную тайну;
- Поставка специализированных компонентов (Xilinx, Altera, Analog Devices, Intersil, Interpoint, Microsemi, Aeroflex, Peregrine, Syfer, Eurofarad, Texas Instrument, Miteq, Cobham, E2V, MA-COM, Hittite, Mini-Circuits, General Dynamics и др.);

Помимо этого, одним из направлений компании «ЭлектроПласт» является направление «Источники питания». Мы предлагаем Вам помощь Конструкторского отдела:

- Подбор оптимального решения, техническое обоснование при выборе компонента;
- Подбор аналогов;
- Консультации по применению компонента;
- Поставка образцов и прототипов;
- Техническая поддержка проекта;
- Защита от снятия компонента с производства.



Как с нами связаться

Телефон: 8 (812) 309 58 32 (многоканальный)

Факс: 8 (812) 320-02-42

Электронная почта: org@eplast1.ru

Адрес: 198099, г. Санкт-Петербург, ул. Калинина, дом 2, корпус 4, литера А.