

Typical units

FEATURES

- Interleaved synchronous rectification yields high efficiency over 90%
- 36 to 75 Vdc input range (48V nominal)
- Outstanding thermal performance and derating
- Low profile 0.40" height with 0.9" x 2.3" outline dimensions
- Fully isolated, 2250 Vdc (BASIC) insulation
- Industry standard DOSA eighth-brick pinout and package and surface mount (SMT) option
- Extensive self-protection and short circuit features
- On/Off control, trim and sense functions
- Fully protected against temperature and voltage limits
- RoHS-6 compliant
- UL/EN/IEC 60950-1 and CAN/CSA C22.2 No. 60950-1, 2nd Edition safety approvals

Output (V)	Current (A)	Nominal Input (V)
3.3	15	48
3.3	25	48
3.3	30	48
5	30	48

For efficient, fully isolated DC power in the smallest space, the UEE open frame DC-DC converter series fit in industry-standard “eighth brick” outline dimensions and mounting pins (on quarter-brick pinout) or surface mount option.

PRODUCT OVERVIEW

Units are offered with a fixed output voltage and current up to 30 Amps. UEEs operate over a wide temperature range (up to +85 degrees Celsius at moderate airflow) with full rated power. Interleaved synchronous rectifier topology yields excellent efficiency.

UEEs achieve these impressive mechanical and environmental specs while delivering excellent electrical performance in an industry standard DOSA compatible through-hole package or surface mount option. The unit is fully protected against input undervoltage, output overcurrent and short circuit. An on-board temperature sensor shuts down the converter if thermal limits are reached

and automatically restarts the converter when the fault is removed.

An On/Off control input enables phased startup and shutdown in multi-voltage applications. UEEs include a Sense input to correct for ohmic losses. A trim input may be connected to a user’s adjustment potentiometer or trim resistors for output voltage calibration.

UEEs include industry-standard safety certifications and BASIC I/O insulation provides input/output isolation to 2250V. Radiation and conducted emission testing is performed to widely accepted EMC standards.

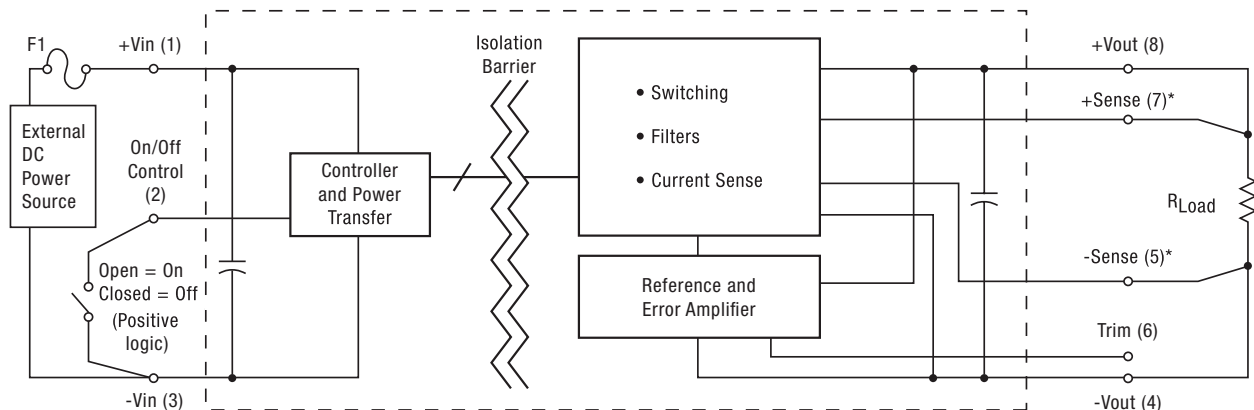

Figure 1. Connection Diagram

Typical topology is shown. Murata Power Solutions recommends an external fuse.



PERFORMANCE SPECIFICATIONS SUMMARY AND ORDERING GUIDE

Model Family	Output						Input				Efficiency		Package		
	V _{OUT} (V)	I _{OUT} (A)	Power (W)	Ripple & Noise (mVp-p)		Regulation (max.)		V _{IN} Nom. (V)	Range (V)	I _{IN} , no load (mA)	I _{IN} , full load (A)	Min.	Typ.	Case	Pinout
				Typ.	Max.	Line	Load								
UEE-3.3/15-D48	3.3	15	50	50	70	±0.1%	±0.1%	48	36-75	30	1.15	88%	90%	C56	P32
UEE-3.3/25-D48	3.3	25	82.5	30	60	±0.1%	±0.2%	48	36-75	100	2.29	88%	90%	C56	P32
UEE-3.3/30-D48	3.3	30	99	30	60	±0.1%	±0.2%	48	36-75	100	2.29	88%	90%	C56	P32
UEE-5/30-D48 ④	5	30	150	50	80	±0.1%	±0.1%	48	36-75	100	3.5	90%	92.00%	C56	P32

- ① Please refer to the model number structure for additional ordering part numbers and options.
- ② All specifications are typical unless noted. General conditions for Specifications are +25 deg.C, V_{in}=nominal, V_{out}=nominal (no trim installed), full rated load. Adequate airflow must be supplied for extended testing under power. All models are tested and specified with external 1µF and 10µF paralleled output capacitors and

no external input capacitor. All capacitors are low ESR types. Caps are layout dependent. These capacitors are necessary to accommodate our test equipment and may not be required in your applications. All models are stable and regulate within spec under no-load conditions.

- ③ Some models are pending safety certification.
- ④ These specifications are preliminary. Contact Murata Power Solutions for availability.

PART NUMBER STRUCTURE

U EE - 3.3 / 30 - D48 N M B H Lx - C

Output Configuration:
U = Unipolar/Single

Eighth-Brick Package

Nominal Output Voltage

Maximum Rated Output
Current in Amps

Input Voltage Range:
D48 = 36-75V,
48V nominal

RoHS Hazardous Materials compliance

C = RoHS6 (does not claim EU RoHS exemption 7b-lead in solder), standard
Y = RoHS5 (with lead), optional, special quantity order

Pin Length Option (Through-hole packages only)

Blank = Standard pin length 0.180 inches (4.6mm)
L1 = Pin length 0.110 inches (2.79mm)*
L2 = Pin length 0.145 inches (3.68mm)*

Conformal coating (optional)

Blank = no coating, standard
H = Coating added, optional, special quantity order
(not available on SMT models)

*Special quantity order is required;
Samples available with standard
pin length only.

Baseplate (optional, not available on UEE-3.3/15-D48 models or SMT models)

Blank = No baseplate, standard
B = Baseplate installed, optional, special quantity order

Surface Mount (SMT models cannot accept the baseplate)

Blank = Thru-hole pin mount, no SMT
M = Surface mount (MSL Rating 2a)

On/Off Control Logic

N = Negative logic, standard
P = Positive logic, optional

Note:
Some model number combinations
may not be available. See website
or contact your local Murata sales
representative.

FUNCTIONAL SPECIFICATIONS, UEE-3.3/15-D48

ABSOLUTE MAXIMUM RATINGS	Conditions ①	Minimum	Typical/Nominal	Maximum	Units
Input Voltage, Continuous		0		80	Vdc
Input Voltage, Transient	Operating or non-operating, 100 mS max. duration	0		100	Vdc
Isolation Voltage	Input to output			2250	Vdc
Input Reverse Polarity	None, install external fuse		None		Vdc
On/Off Remote Control	Power on or off, referred to -Vin	-0.8		13.5	Vdc
Output Power		0		50	W
Output Current	Current-limited, no damage, short-circuit protected	0		15	A
Storage Temperature Range	Vin = Zero (no power)	-55		125	°C
Absolute maximums are stress ratings. Exposure of devices to greater than any of these conditions may adversely affect long-term reliability. Proper operation under conditions other than those listed in the Performance/Functional Specifications Table is not implied or recommended.					
INPUT	Conditions ① ③				
Operating voltage range		36	48	75	Vdc
Recommended External Fuse	Fast blow			10	A
Start-up threshold	Rising input voltage	33	34	35	Vdc
Undervoltage shutdown	Falling input voltage	31	32	33	Vdc
Overvoltage shutdown			None		Vdc
Reverse Polarity Protection	None, install external fuse		None		Vdc
Internal Filter Type			Pi		
Input current					
Full Load Conditions	Vin = nominal		1.15	1.18	A
Low Line	Vin = minimum		1.53	1.58	A
Inrush Transient			0.01	0.03	A ² -Sec.
Output in Short Circuit			72	100	mA
No Load	Iout = minimum, unit = ON		30	50	mA
Standby Mode (Off, UV, OT)			4.6	10	mA
Reflected (back) ripple current ②	Measured at input with specified filter			30	mA, P-P
GENERAL and SAFETY					
Efficiency	Vin = 48V, full load	88.0	90.0		%
	Vin = min, full load	88.0	90.0		%
Isolation					
Isolation Voltage, input to output	No baseplate	2250			Vdc
Isolation Voltage, input to baseplate	N/A	N/A			Vdc
Isolation Voltage, output to baseplate	N/A	N/A			Vdc
Insulation Safety Rating			basic		
Isolation Resistance			10		MΩ
Isolation Capacitance			1000		pF
Safety	Certified to UL-60950-1, CSA-C22.2 No.60950-1, IEC/EN60950-1, 2nd edition		Yes		
Calculated MTBF	Per Telcordia SR-332, issue 1, class 3, ground fixed, Tcase = +25°C		2.3		Hours x 10 ⁶
DYNAMIC CHARACTERISTICS					
Fixed Switching Frequency		300	330	360	KHz
Startup Time	Power on to Vout regulated			10	mS
Startup Time	Remote ON to Vout regulated			10	mS
Dynamic Load Response	50-75-50% load step, settling time to within ±1% of Vout		220	300	µSec
Dynamic Load Peak Deviation	same as above		±150	±200	mV
FEATURES and OPTIONS					
Remote On/Off Control ④					
"N" suffix:					
Negative Logic, ON state	ON=Ground pin or external voltage	-0.8		1	Vdc
Negative Logic, OFF state	OFF=Pin open or external voltage	2.5		13.5	Vdc
Control Current	sinking		1	2	mA
"P" suffix:					
Positive Logic, ON state	ON=Pin open or external voltage	2.5		13.5	V
Positive Logic, OFF state	OFF=Ground pin or external voltage	-0.8		1	V
Control Current	sinking		1	2	mA
BasePlate	"B" suffix		N/A		
Conformal Coating	"H" suffix		optional		

FUNCTIONAL SPECIFICATIONS, UEE-3.3/15-D48 (CONT.)

OUTPUT	Conditions ①	Minimum	Typical/Nominal	Maximum	Units
Total Output Power		0.0	49.5	50	W
Voltage					
Nominal Output Voltage	No trim	3.267	3.30	3.333	Vdc
Setting Accuracy	At 50% load	-1		+1	% of Vset.
Output Voltage Range	User-adjustable	-10		+10	% of Vnom.
Overvoltage Protection	Via magnetic feedback	3.7	4.3	5.1	Vdc
Current					
Output Current Range		0.0	15	15	A
Minimum Load			No minimum load		
Current Limit Inception	98% of Vnom., after warmup	18	22	26	A
Short Circuit					
Short Circuit Current	Hiccup technique, autorecovery within $\pm 1.25\%$ of Vout		1.97	3	A
Short Circuit Duration (remove short for recovery)	Output shorted to ground, no damage		Continuous		
Short circuit protection method	Current limiting		Yes		
Regulation					
Line Regulation	Vin=min. to max., Vout=nom., Iout=nom.			± 0.1	% of Vout
Load Regulation	Iout=min. to max., Vin=48V			± 0.1	% of Vout
Ripple and Noise ②	5 Hz - 20 MHz BW		50	70	mV pk-pk
Temperature Coefficient	At all outputs		± 0.0046	± 0.005	% of Vout./°C
Maximum Capacitive Loading	Cap. ESR= $<0.02\Omega$, full resistive load	0		7500	μF
Remote Sense Compliance	Sense connected at load			10	% of Vout
MECHANICAL (Through Hole Models)					
Outline Dimensions (no baseplate)	C56 case		2.3x0.9x0.40 max.		Inches
(Please refer to outline drawing)	WxLxH		58.4x22.9x10.16		mm
Outline Dimensions (with baseplate)			2.3x0.9x0.50		Inches
			58.4x22.9x12.7		mm
Weight	No baseplate		1.09		Ounces
	No baseplate		31		Grams
	With baseplate		N/A		Ounces
	With baseplate		N/A		Grams
Through Hole Pin Diameter			0.04 & 0.062		Inches
			1.016&1.524		mm
Through Hole Pin Material			Copper alloy		
TH Pin Plating Metal and Thickness	Nickel subplate		100-299		μ -inches
	Gold overplate		10-31		μ -inches
Baseplate Material			Aluminum		
ENVIRONMENTAL					
Operating Ambient Temperature Range	No Derating, 100 LFM, full power, vertical mount	-40		85	°C
Operating Case Temperature	No derating	-40		115	°C
Storage Temperature	Vin = Zero (no power)	-55		125	°C
Thermal Protection/Shutdown	Measured in center	115	125	135	°C
Electromagnetic Interference	External filter is required				
Conducted, EN55022/CISPR22			B		Class
Radiated, EN55022/CISPR22			B		Class
Relative humidity, non-condensing	To +85°C	10		90	%RH
Altitude	must derate -1%/1000 feet	-500		10,000	feet
		-152		3048	meters
RoHS rating			RoHS-6		

Notes

- Unless otherwise noted, all specifications are at nominal input voltage, nominal output voltage and full load.
General conditions are +25° Celsius ambient temperature, near sea level altitude, natural convection airflow.
All models are tested and specified with external parallel 1 μF and 10 μF multi-layer ceramic output capacitors.
No external input capacitor is used. All capacitors are low-ESR types wired close to the converter. These capacitors are necessary for our test equipment and may not be needed in the user's application.
- Input (back) ripple current is tested and specified over 5 Hz to 20 MHz bandwidth. Input filtering is Cbus=220 μF , Cin=33 μF and Lbus=12 μH .
- All models are stable and regulate to specification under no load.
- The Remote On/Off Control is referred to -Vin. For external transistor control, use open collector logic or equivalent.

- NOTICE**—Please use only this customer data sheet as product documentation when laying out your printed circuit boards and applying this product into your application. Do NOT use other materials as official documentation such as advertisements, product announcements, or website graphics. We strive to have all technical data in this customer data sheet highly accurate and complete. This customer data sheet is revision-controlled and dated. The latest customer data sheet revision is normally on our website (www.murata-ps.com) for products which are fully released to Manufacturing. Please be especially careful using any data sheets labeled "Preliminary" since data may change without notice. The pinout (Pxx) and case (Cxx) designations (typically P32 or C56) refer to a generic family of closely related information. It may not be a single pinout or unique case outline. Please be aware of small details which may affect your application and PC board layouts. Study the Mechanical Outline drawings, Input/Output Connection table and all footnotes very carefully. Please contact Murata Power Solutions if you have any questions.

TYPICAL PERFORMANCE DATA AND OSCILLOGRAMS, UEE-3.3/15-D48

UEE-3.3/15-D48 Efficiency and Power Dissipation @ Ta = +25°C

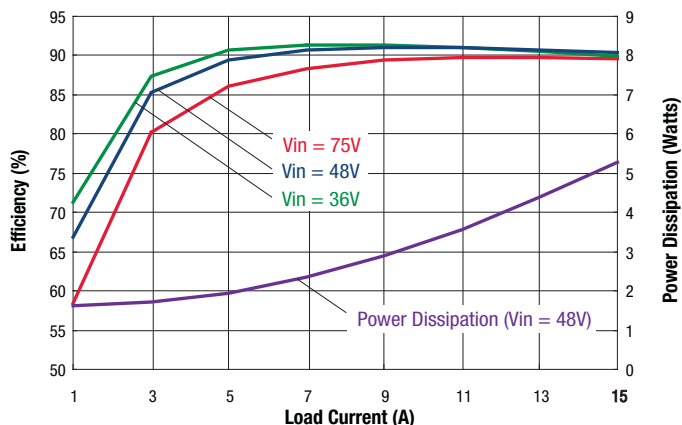

UEE-3.3/15-D48 Maximum Current Temperature Derating at Sea Level
(Vin = 48V, no baseplate, airflow is from Vin to Vout)

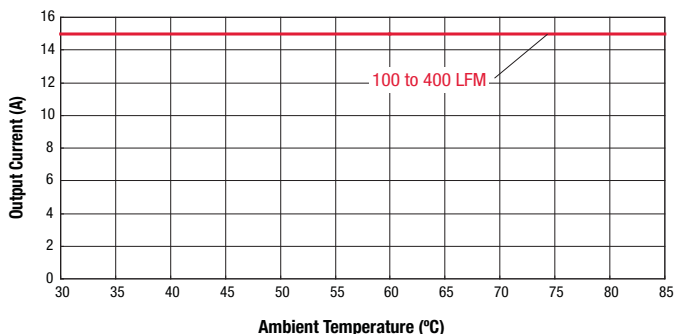

UEE-3.3/15-D48 Maximum Current Temperature Derating at Sea Level
(Vin = 48V, no baseplate, airflow is from -Vin to +Vin)

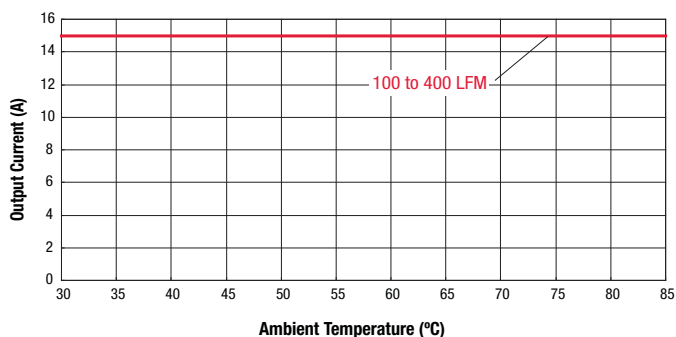

Step Load Transient Response (Vin=48V, Vout=nominal, Load=0, Iout=75% to 50% of full load, Ta=+25°C.) Trace 1=Vout, 100 mV/div., 500 μS/div.

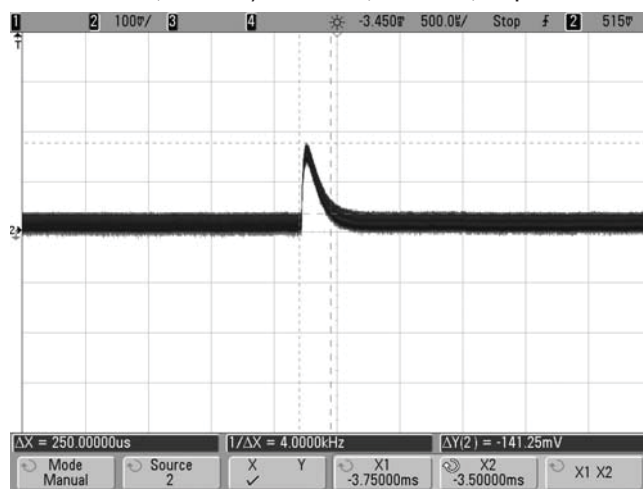

Step Load Transient Response (Vin=48V, Vout=nominal, Load=0, Iout=50% to 75% of full load, Ta=+25°C.) Trace 1=Vout, 100 mV/div., 500 μS/div.

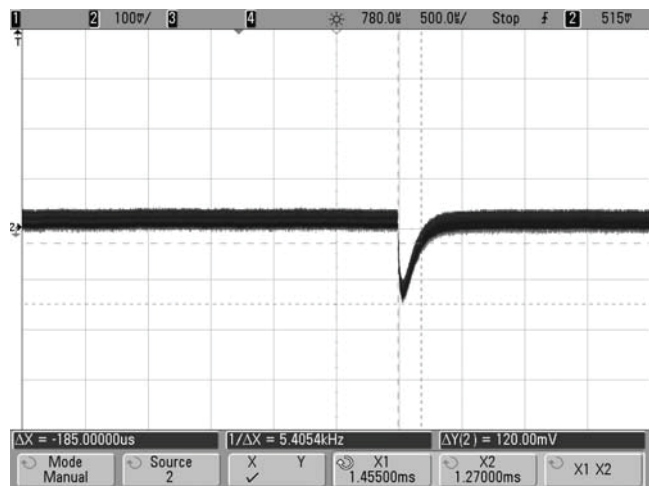

Step Load Transient Response (Vin=48V, Vout=nominal, Load=0, Iout=50 to 75 to 50% of full load, Ta=+25°C.) Trace 1=Vout, 100 mV/div., 2 mS/div.

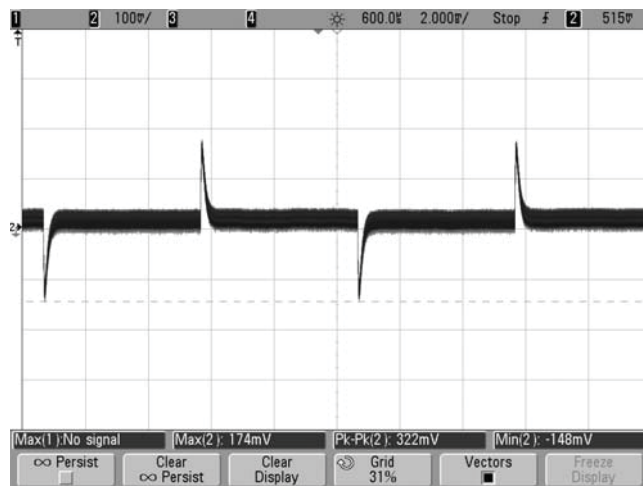

Isolated, High-Density, Eighth-Brick
DOSA Low Profile DC-DC Converters

TYPICAL PERFORMANCE DATA AND OSCILLOGRAMS, UEE-3.3/15-D48

Power On Start Up (Vin=48V, Vout=nom., Iout=15A, Cload=0, Ta=+25° C., ScopeBW=20Mhz, Trace 2=Vout, Trace 4=Enable.)

Power On Start Up (Vin=48V, Vout=nom., Iout=0A, Cload=0, Ta=+25° C., ScopeBW=20Mhz, Trace 2=Vout, Trace 4=Enable)

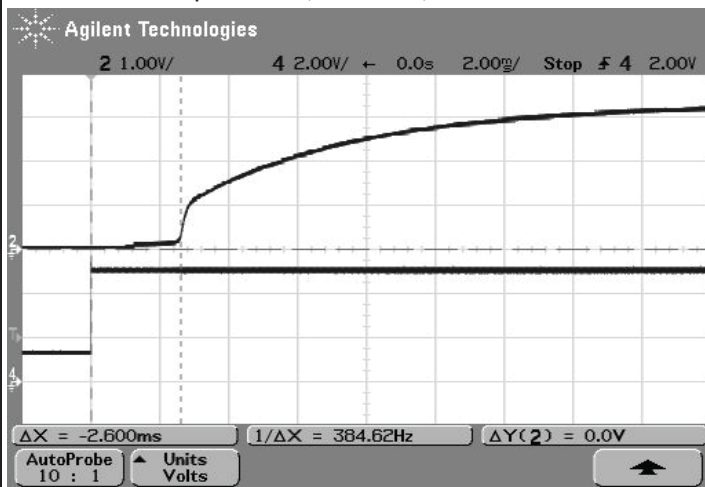
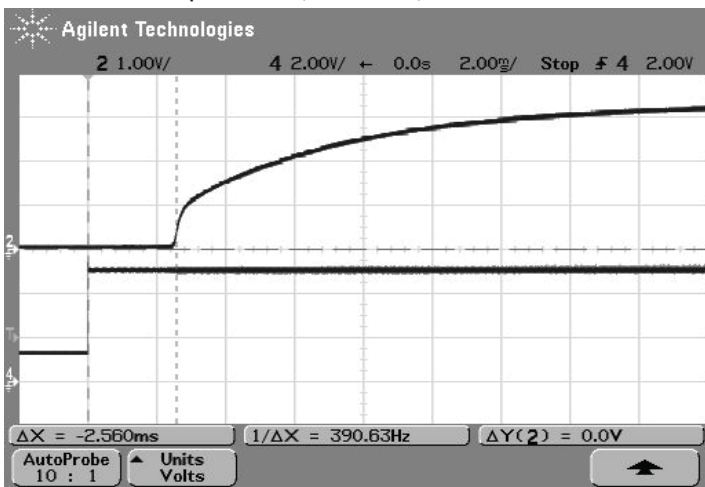

Power On Start Up (Vin=48V, Vout=nom., Iout=15A, Cload=7500uF, Ta=+25° C., ScopeBW=20Mhz, Trace 2=Vout, Trace 4=Enable)

Output Ripple and noise (Vin=48V, Vout=nom., Iout=15A, Cload=0, Ta=+25° C., ScopeBW=20Mhz)

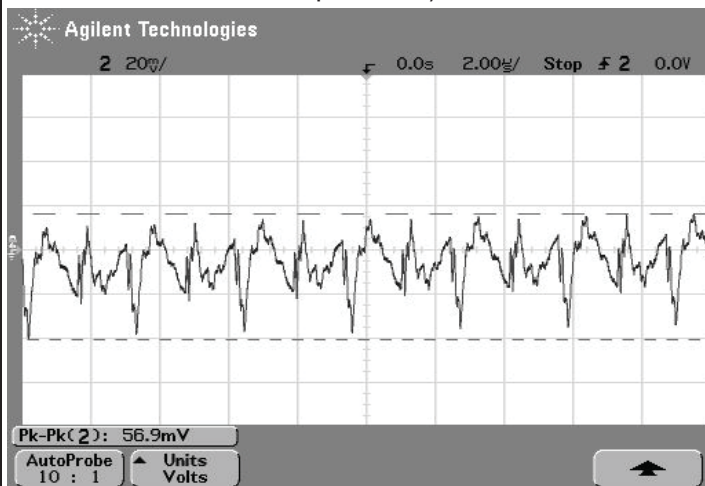
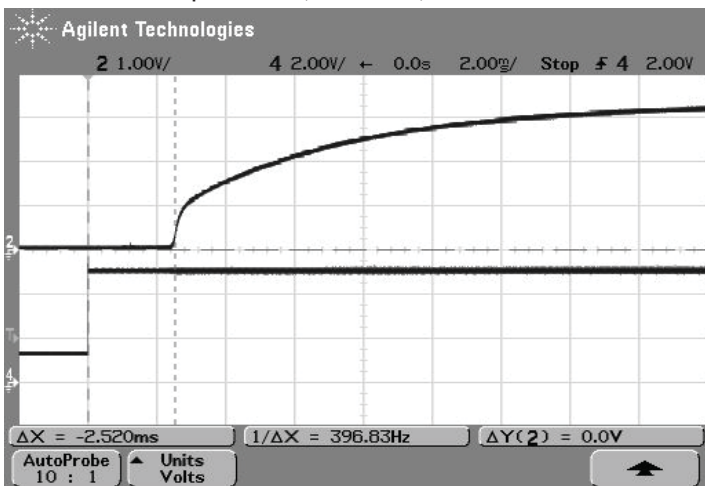

Output Ripple and noise (Vin=48V, Vout=nom., Iout=0A, Cload=0, Ta=+25° C., ScopeBW=20Mhz)

Thermal image with hot spot at full load current with 85 °C ambient; air is flowing at 100 LFM. Air is flowing across the converter from -Vin to +Vin at 48V input. Identifiable and recommended maximum value to be verified in application. Q9, Max temp= 120 °C/IPC9592 derating guidelines.

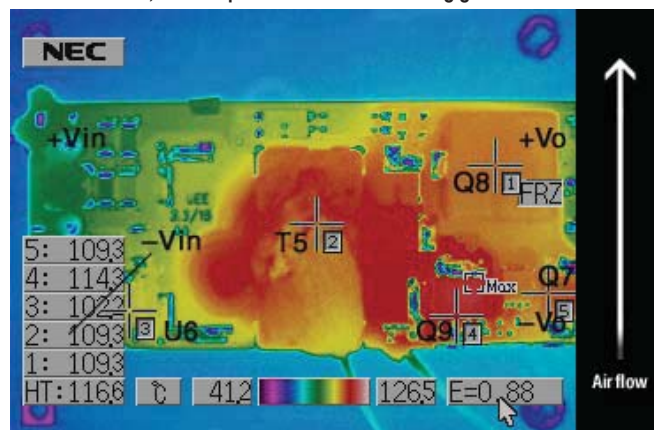
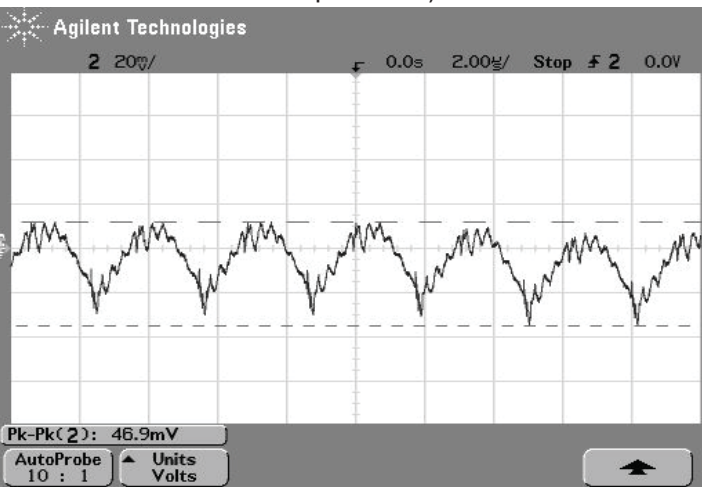

Isolated, High-Density, Eighth-Brick
DOSA Low Profile DC-DC Converters

Emissions Performance, Model UEE-3.3/15-D48

Murata Power Solutions measures its products for radio frequency emissions against the EN 55022 and CISPR 22 standards. Passive resistance loads are employed and the output is set to the maximum voltage. If you set up your own emissions testing, make sure the output load is rated at continuous power while doing the tests.

The recommended external input and output capacitors (if required) are included. Please refer to the fundamental switching frequency. All of this information is listed in the Product Specifications. An external discrete filter is installed and the circuit diagram is shown below.

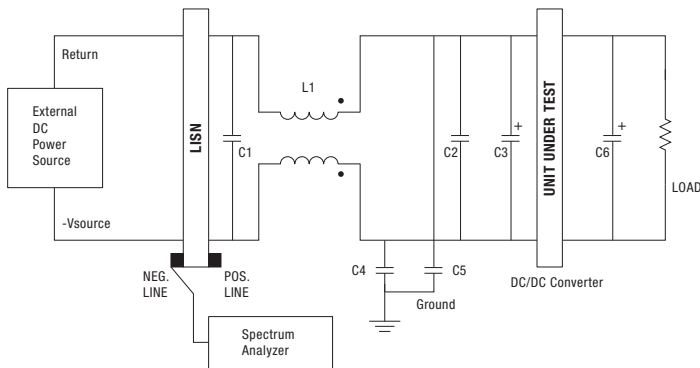

Figure 2. Conducted Emissions Test Circuit

[1] Conducted Emissions Parts List

Designation	Value	Part Number	Description	Vendor
C1	1 μ F	GRM32ER72A105KA01L	SMD Ceramic, 100V, 1000nF, X7R-1210	Murata
C2	100 nF	GRM319R72A104KA01D	SMD Ceramic, 100V, 100nF \pm 10%, X7R-1206	Murata
L1	1320 μ H	LB16H1324	Common Mode choke, 1320 μ H, \pm 25%, 4A, R5K, *21*21*12.5mm	High Light
C4, C5	0.022 μ F	GRM32DR73A223KW01L	SMD Ceramic, 1000V, 0.022 μ F, \pm 10%, X7R-1210	Murata
C3	220 μ F	UHE2A221MHD	Alum. electrolytic, 100V, 220 μ F, \pm 10%, long lead	Nichicon
C6	Not used		Not used for this model	

[2] Conducted Emissions Test Equipment Used

Spectrum Analyzer – Hewlett Packard HP8594L

Line Impedance Stabilization Network (LISN) – 2 Line V-Networks LS1-15V, 50 Ω , 50 μ H

[3] Conducted Emissions Test Results

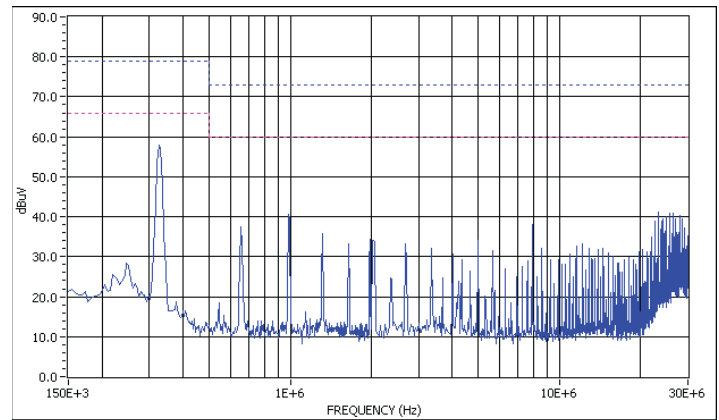

Peak Detection Value

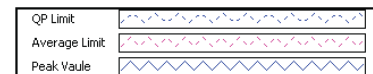

Graph 1. Conducted emissions performance, Positive Line, CISPR 22, Class A, full load

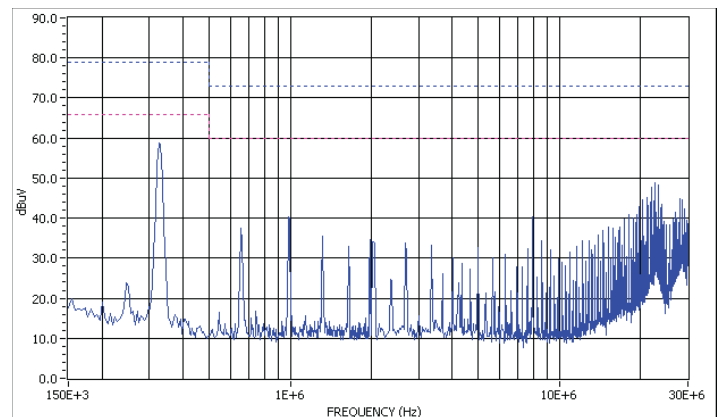

Peak Detection Value

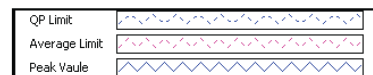

Graph 2. Conducted emissions performance, Negative Line, CISPR 22, Class A, full load

[4] Layout Recommendations

Most applications can use the filtering which is already installed inside the converter or with the addition of the recommended external capacitors. For greater emissions suppression, consider additional filter components and/or shielding. Emissions performance will depend on the user's PC board layout, the chassis shielding environment and choice of external components. Please refer to Application Note GEAN02 for further discussion.

Since many factors affect both the amplitude and spectra of emissions, we recommend using an engineer who is experienced at emissions suppression.

FUNCTIONAL SPECIFICATIONS, UEE-3.3/25-D48

ABSOLUTE MAXIMUM RATINGS	Conditions ①	Minimum	Typical/Nominal	Maximum	Units
Input Voltage, Continuous		0		80	Vdc
Input Voltage, Transient	Operating or non-operating, 100 mS max. duration	0		100	Vdc
Isolation Voltage	Input to output			2250	Vdc
Input Reverse Polarity	None, install external fuse		None		Vdc
On/Off Remote Control	Power on or off, referred to -Vin	0		13.5	Vdc
Output Power		0		83.3	W
Output Current	Current-limited, no damage, short-circuit protected	0		25	A
Storage Temperature Range	Vin = Zero (no power)	-55		125	°C
Absolute maximums are stress ratings. Exposure of devices to greater than any of these conditions may adversely affect long-term reliability. Proper operation under conditions other than those listed in the Performance/Functional Specifications Table is not implied or recommended.					
INPUT	Conditions ① ③				
Operating voltage range		36	48	75	Vdc
Recommended External Fuse	Fast blow			10	A
Start-up threshold	Rising input voltage	33	34	35	Vdc
Undervoltage shutdown	Falling input voltage	31	32	33	Vdc
Overvoltage shutdown			None		Vdc
Reverse Polarity Protection	None, install external fuse		None		Vdc
Internal Filter Type			Pi		
Input current					
Full Load Conditions	Vin = nominal		2.29	2.37	A
Low Line	Vin = minimum		3.06	3.16	A
Inrush Transient			0.05	0.6	A ² -Sec.
Output in Short Circuit			150	300	mA
No Load	Iout = minimum, unit = ON		100	150	mA
Standby Mode (Off, UV, OT)			5	10	mA
Reflected (back) ripple current ②	Measured at input with specified filter			30	mA, P-P
GENERAL and SAFETY					
Efficiency	Vin = 48V, full load	88.0	90.0		%
	Vin = min, full load	88.0	90.0		%
Isolation					
Isolation Voltage, input to output	No baseplate	2250			Vdc
Isolation Voltage, input to baseplate	With baseplate	1500			Vdc
Isolation Voltage, output to baseplate	With baseplate	1500			Vdc
Insulation Safety Rating			basic		
Isolation Resistance			10		MΩ
Isolation Capacitance			1000		pF
Safety	Certified to UL-60950-1, CSA-C22.2 No.60950-1, IEC/EN60950-1, 2nd edition		Yes		
Calculated MTBF	Per Telcordia SR-332, issue 1, class 3, ground fixed, Tcase = +25°C		2.5		Hours x 10 ⁶
DYNAMIC CHARACTERISTICS					
Fixed Switching Frequency		320	350	380	KHz
Startup Time	Power on to Vout regulated			10	mS
Startup Time	Remote ON to Vout regulated			10	mS
Dynamic Load Response	50-75-50% load step, settling time to within ±1% of Vout		150	300	μSec
Dynamic Load Peak Deviation	same as above		±150	±200	mV
FEATURES and OPTIONS					
Remote On/Off Control ④					
"N" suffix:					
Negative Logic, ON state	ON=Ground pin or external voltage	-0.8		1	Vdc
Negative Logic, OFF state	OFF=Pin open or external voltage	2.5		13.5	Vdc
Control Current	sinking		1	2	mA
"P" suffix:					
Positive Logic, ON state	ON=Pin open or external voltage	2.5		13.5	V
Positive Logic, OFF state	OFF=Ground pin or external voltage	-0.8		1	V
Control Current	sinking		1	2	mA
Base Plate	"B" suffix		optional		
Conformal Coating	"H" suffix		optional		

FUNCTIONAL SPECIFICATIONS, UEE-3.3/25-D48 (CONT.)

OUTPUT	Conditions ①	Minimum	Typical/Nominal	Maximum	Units
Total Output Power		0.0	82.5	83.3	W
Voltage					
Nominal Output Voltage	No trim	3.267	3.30	3.333	Vdc
Setting Accuracy	At 50% load	-1		+1	% of Vset.
Output Voltage Range	User-adjustable	-10		+10	% of Vnom.
Overvoltage Protection	Via magnetic feedback	3.7	4	4.9	Vdc
Current					
Output Current Range		0.0	25	25	A
Minimum Load			No minimum load		
Current Limit Inception	98% of Vnom., after warmup	28	31	34	A
Short Circuit					
Short Circuit Current	Hiccup technique, autorecovery within $\pm 1.25\%$ of Vout		3	4	A
Short Circuit Duration (remove short for recovery)	Output shorted to ground, no damage		Continuous		
Short circuit protection method	Current limiting		Yes		
Regulation					
Line Regulation	Vin=min. to max., Vout=nom., Iout=nom.			± 0.1	% of Vout
Load Regulation	Iout=min. to max., Vin=48V			± 0.2	% of Vout
Ripple and Noise ②	5 Hz - 20 MHz BW		30	60	mV pk-pk
Temperature Coefficient	At all outputs		0.02		% of Vout./°C
Maximum Capacitive Loading	Cap. ESR= $<0.02\Omega$, full resistive load	0		10,000	μF
Remote Sense Compliance	Sense connected at load			10	% of Vout
MECHANICAL (Through Hole Models)					
Outline Dimensions (no baseplate)	C56 case		2.3x0.9x0.40 max.		Inches
(Please refer to outline drawing)	WxLxH		58.4x22.9x10.16		mm
Outline Dimensions (with baseplate)			2.3x0.9x0.50		Inches
			58.4x22.9x12.7		mm
Weight	No baseplate		1.09		Ounces
	No baseplate		31		Grams
	With baseplate		TBD		Ounces
	With baseplate		TBD		Grams
Through Hole Pin Diameter			0.04 & 0.062		Inches
			1.016&1.524		mm
Through Hole Pin Material			Copper alloy		
TH Pin Plating Metal and Thickness	Nickel subplate		100-299		μ -inches
	Gold overplate		10-31		μ -inches
Baseplate Material			Aluminum		
ENVIRONMENTAL					
Operating Ambient Temperature Range	No Derating, 100 LFM, full power, vertical mount	-40		85	°C
Operating Case Temperature	No derating	-40		125	°C
Storage Temperature	Vin = Zero (no power)	-55		125	°C
Thermal Protection/Shutdown	Measured in center	115	125	135	°C
Electromagnetic Interference	External filter is required				
Conducted, EN55022/CISPR22			B		Class
Radiated, EN55022/CISPR22			B		Class
Relative humidity, non-condensing	To +85°C	10		90	%RH
Altitude	must derate -1%/1000 feet	-500		10,000	feet
		-152		3048	meters
RoHS rating			RoHS-6		

Notes

- Unless otherwise noted, all specifications are at nominal input voltage, nominal output voltage and full load.
General conditions are +25° Celsius ambient temperature, near sea level altitude, natural convection airflow.
All models are tested and specified with external parallel 1 μF and 10 μF multi-layer ceramic output capacitors.
No external input capacitor is used. All capacitors are low-ESR types wired close to the converter. These capacitors are necessary for our test equipment and may not be needed in the user's application.
- Input (back) ripple current is tested and specified over 5 Hz to 20 MHz bandwidth. Input filtering is Cbus=220 μF , Cin=33 μF and Lbus=12 μH .
- All models are stable and regulate to specification under no load.
- The Remote On/Off Control is referred to -Vin. For external transistor control, use open collector logic or equivalent.

- NOTICE**—Please use only this customer data sheet as product documentation when laying out your printed circuit boards and applying this product into your application. Do NOT use other materials as official documentation such as advertisements, product announcements, or website graphics. We strive to have all technical data in this customer data sheet highly accurate and complete. This customer data sheet is revision-controlled and dated. The latest customer data sheet revision is normally on our website (www.murata-ps.com) for products which are fully released to Manufacturing. Please be especially careful using any data sheets labeled "Preliminary" since data may change without notice. The pinout (Pxx) and case (Cxx) designations (typically P32 or C56) refer to a generic family of closely related information. It may not be a single pinout or unique case outline. Please be aware of small details which may affect your application and PC board layouts. Study the Mechanical Outline drawings, Input/Output Connection table and all footnotes very carefully. Please contact Murata Power Solutions if you have any questions.

TYPICAL PERFORMANCE DATA AND OSCILLOGRAMS, UEE-3.3/25-D48

UEE-3.3/25-D48 Efficiency and Power Dissipation @ Ta = +25°C

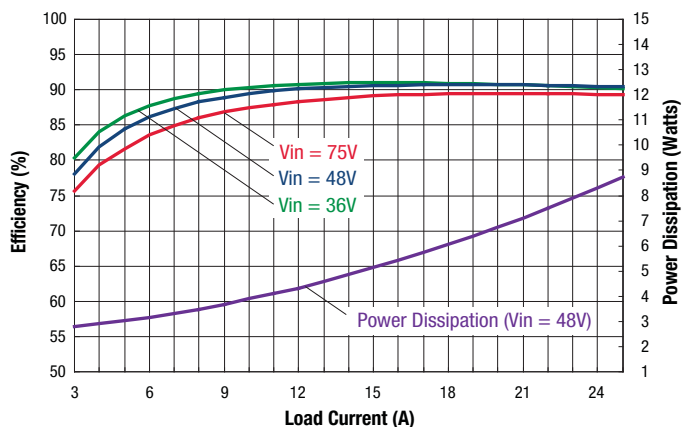

UEE-3.3/25-D48 Maximum Current Temperature Derating at Sea Level
(Vin = 48V, no baseplate. Airflow direction is longitudinal, from Vin to Vout.)

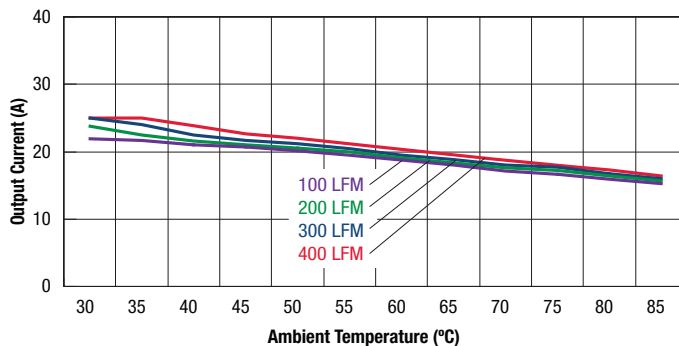

UEE-3.3/25-D48 Maximum Current Temperature Derating at Sea Level
(Vin = 48V, with baseplate. Airflow direction is from Vin to Vout.)

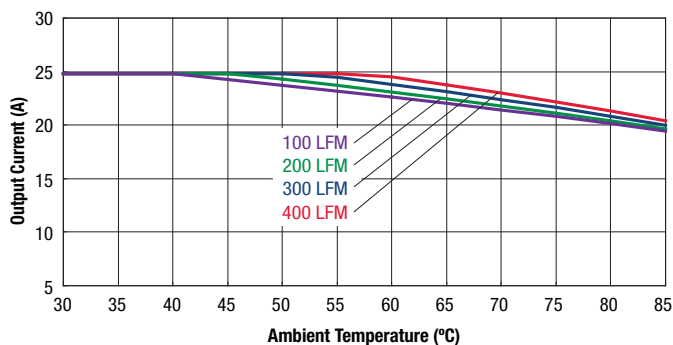

UEE-3.3/25-D48 Maximum Current Temperature Derating at Sea Level
(Vin = 48V, with baseplate. Airflow direction is transverse from +Vin to -Vin.)

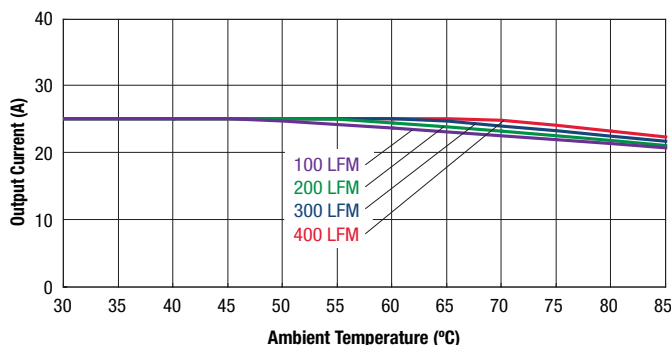

UEE-3.3/25-D48 Maximum Current Temperature Derating at Sea Level
(Vin = 48V, no baseplate. Airflow direction is transverse.)

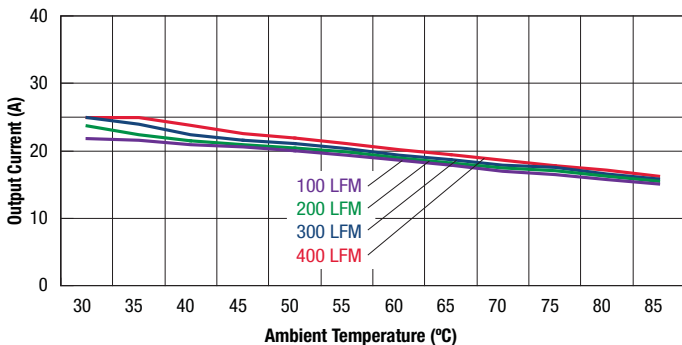

UEE-3.3/25-D48 Maximum Current Temperature Derating at Sea Level
(Vin = 48V, no baseplate. Airflow direction is transverse.)

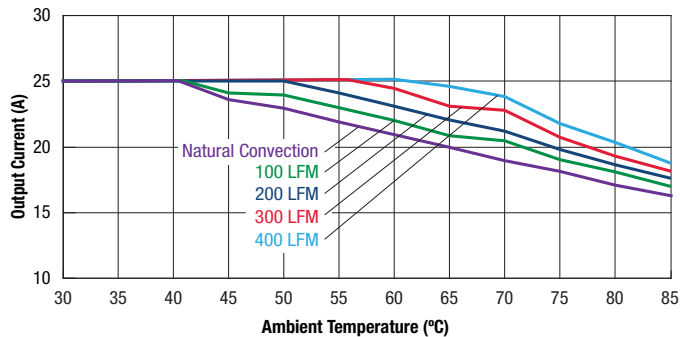

TYPICAL PERFORMANCE DATA AND OSCILLOGRAMS, UEE-3.3/25-D48

Step Load Transient Response (Slew=1A / μ Sec., Vin=48V., Clod=0, Iout=22.5A to 15A)



Step Load Transient Response (Slew=1A / μ Sec., Vin=48V., Clod=0, Iout=15A to 22.5A)

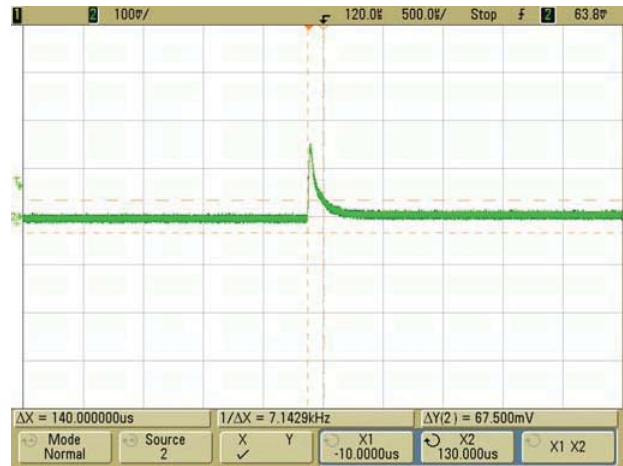

On/Off Enable Delay (Vin=48V, Vout=nom., Iout=30A, Clod=0, Ta=+25° C.,
ScopeBW=20Mhz, Trace 2=Vout, Trace 4=Enable.

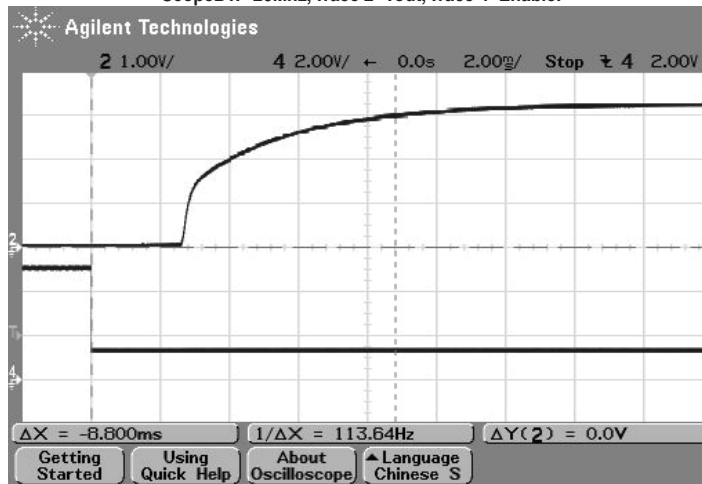

On/Off Enable Delay (Vin=48V, Vout=nom., Iout=0A, Clod=0, Ta=+25° C.,
ScopeBW=20Mhz, Trace 2=Vout, Trace 4=Enable.

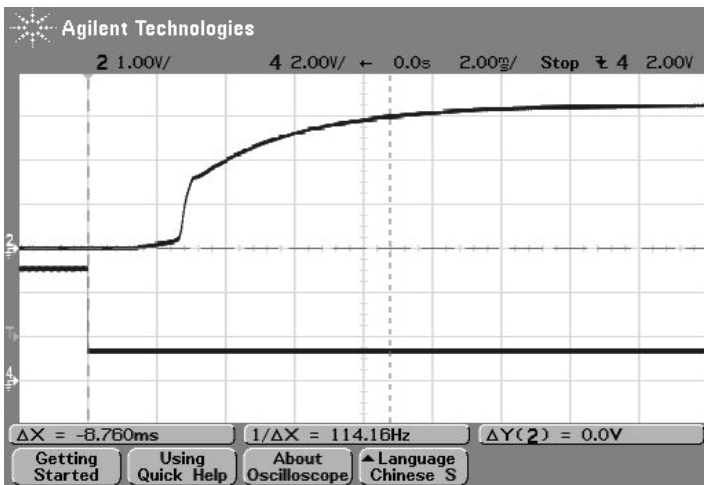

On/Off Enable Delay (Vin=48V, Vout=nom., Iout=30A, Clod=10uF, Ta=+25° C.,
ScopeBW=20Mhz, Trace 2=Vout, Trace 4=Enable.

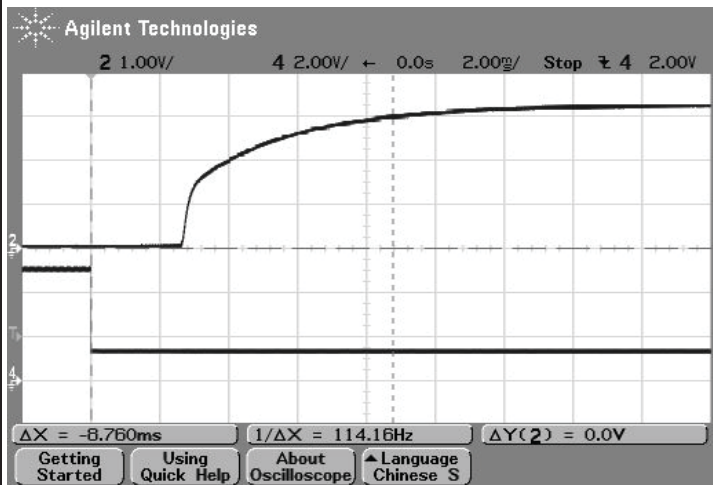

TYPICAL PERFORMANCE DATA AND OSCILLOGRAMS, UEE-3.3/25-D48

Output Ripple and noise (Vin=48V, Vout=nom., Iout=30A, Cload=0, Ta=+25° C., ScopeBW=20Mhz)

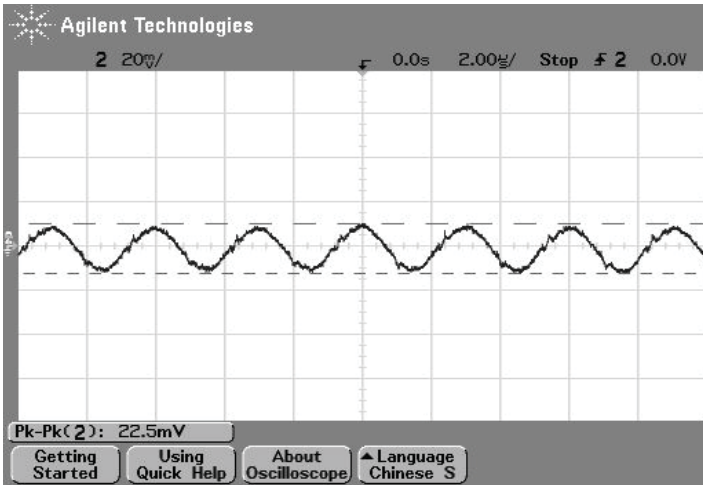

Output Ripple and noise (Vin=48V, Vout=nom., Iout=30A, Cload=0, Ta=+25° C., ScopeBW=20Mhz)

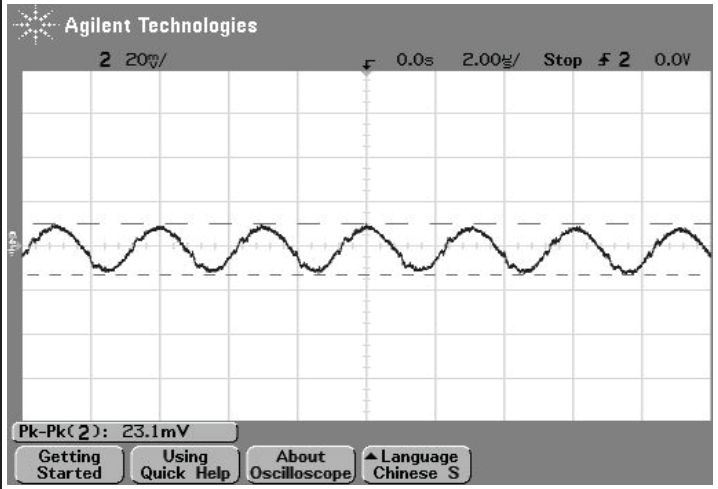

Thermal image with hot spot at full load current with 85 °C ambient; air is flowing at 200 LFM. Air is flowing across the converter from Vin to Vout at 48V input. Identifiable and recommended maximum value to be verified in application.
T1 & Q1, Max temp= 120 °C/IPC9592 derating guidelines.

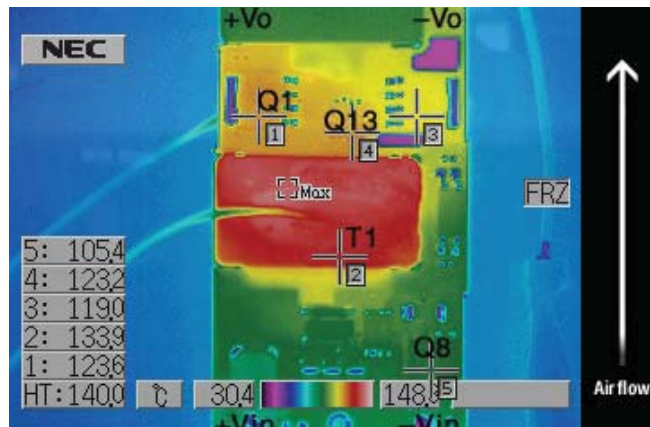

Isolated, High-Density, Eighth-Brick
DOSA Low Profile DC-DC Converters

Emissions Performance, Model UEE-3.3/25-D48

Murata Power Solutions measures its products for radio frequency emissions against the EN 55022 and CISPR 22 standards. Passive resistance loads are employed and the output is set to the maximum voltage. If you set up your own emissions testing, make sure the output load is rated at continuous power while doing the tests.

The recommended external input and output capacitors (if required) are included. Please refer to the fundamental switching frequency. All of this information is listed in the Product Specifications. An external discrete filter is installed and the circuit diagram is shown below.

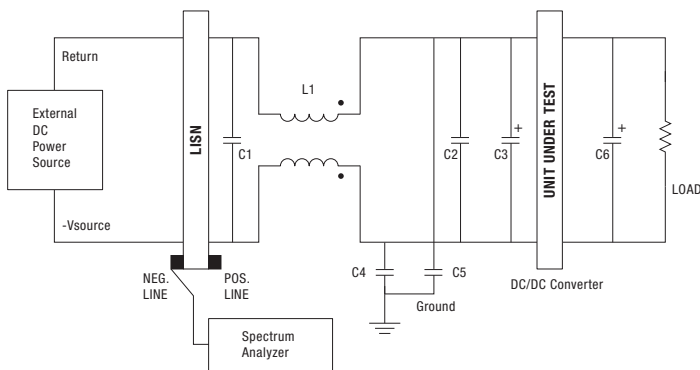

Figure 3. Conducted Emissions Test Circuit

[1] Conducted Emissions Parts List

Designation	Value	Part Number	Description	Vendor
C1	1 μ F	GRM32ER72A105KA01L	SMD Ceramic, 100V, 1000nF, X7R-1210	Murata
C2	100 nF	GRM319R72A104KA01D	SMD Ceramic, 100V, 100nF \pm 10%, X7R-1206	Murata
L1	1320 μ H	LB16H1324	Common Mode choke, 1320 μ H, \pm 25%, 4A, R5K, *21*21*12.5mm	High Light
C4, C5	0.022 μ F	GRM32DR73A223KW01L	SMD Ceramic, 1000V, 0.022 μ F, \pm 10%, X7R-1210	Murata
C3	220 μ F	UHE2A221MHD	Alum. electrolytic, 100V, 220 μ F, \pm 10%, long lead	Nichicon
C6	Not used		Not used for this model	

[2] Conducted Emissions Test Equipment Used

Spectrum Analyzer – Hewlett Packard HP8594L

Line Impedance Stabilization Network (LISN) – 2 Line V-Networks LS1-15V, 50 Ω , 50 μ H

[3] Conducted Emissions Test Results

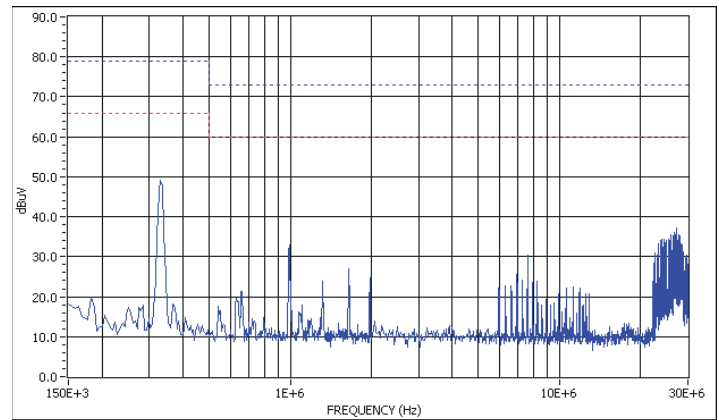

Peak Detection Value

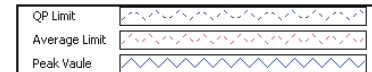

Graph 3. Conducted emissions performance, Positive Line, CISPR 22, Class A, full load

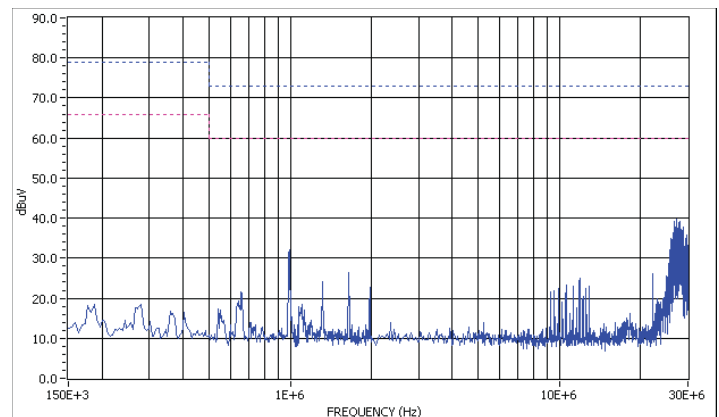

Peak Detection Value

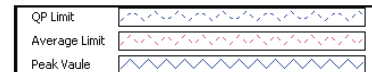

Graph 4. Conducted emissions performance, Negative Line, CISPR 22, Class A, full load

[4] Layout Recommendations

Most applications can use the filtering which is already installed inside the converter or with the addition of the recommended external capacitors. For greater emissions suppression, consider additional filter components and/or shielding. Emissions performance will depend on the user's PC board layout, the chassis shielding environment and choice of external components. Please refer to Application Note GEANO2 for further discussion.

Since many factors affect both the amplitude and spectra of emissions, we recommend using an engineer who is experienced at emissions suppression.

FUNCTIONAL SPECIFICATIONS, UEE-3.3/30-D48

ABSOLUTE MAXIMUM RATINGS	Conditions ①	Minimum	Typical/Nominal	Maximum	Units
Input Voltage, Continuous		0		80	Vdc
Input Voltage, Transient	Operating or non-operating, 100 mS max. duration	0		100	Vdc
Isolation Voltage	Input to output			2250	Vdc
Input Reverse Polarity	None, install external fuse		None		Vdc
On/Off Remote Control	Power on or off, referred to -Vin	0		13.5	Vdc
Output Power		0		100	W
Output Current	Current-limited, no damage, short-circuit protected	0		30	A
Storage Temperature Range	Vin = Zero (no power)	-55		125	°C
Absolute maximums are stress ratings. Exposure of devices to greater than any of these conditions may adversely affect long-term reliability. Proper operation under conditions other than those listed in the Performance/Functional Specifications Table is not implied or recommended.					
INPUT	Conditions ① ③				
Operating voltage range		36	48	75	Vdc
Recommended External Fuse	Fast blow			10	A
Start-up threshold	Rising input voltage	33	34	35	Vdc
Undervoltage shutdown	Falling input voltage	31	32	33	Vdc
Overvoltage shutdown			None		Vdc
Reverse Polarity Protection	None, install external fuse		None		Vdc
Internal Filter Type			Pi		
Input current					
Full Load Conditions	Vin = nominal		2.29	2.37	A
Low Line	Vin = minimum		3.06	3.16	A
Inrush Transient			0.05	0.6	A ² -Sec.
Output in Short Circuit			150	300	mA
No Load	Iout = minimum, unit = ON		100	150	mA
Standby Mode (Off, UV, OT)			5	10	mA
Reflected (back) ripple current ②	Measured at input with specified filter			30	mA, P-P
GENERAL and SAFETY					
Efficiency	Vin = 48V, full load	88.0	90.0		%
	Vin = min, full load	88.0	90.0		%
Isolation					
Isolation Voltage, input to output	No baseplate	2250			Vdc
Isolation Voltage, input to baseplate	With baseplate	1500			Vdc
Isolation Voltage, output to baseplate	With baseplate	1500			Vdc
Insulation Safety Rating			basic		
Isolation Resistance			10		MΩ
Isolation Capacitance			1000		pF
Safety	Certified to UL-60950-1, CSA-C22.2 No.60950-1, IEC/EN60950-1, 2nd edition		Yes		
Calculated MTBF	Per Telcordia SR-332, issue 1, class 3, ground fixed, Tcase = +25°C		2.5		Hours x 10 ⁶
DYNAMIC CHARACTERISTICS					
Fixed Switching Frequency		320	350	380	KHz
Startup Time	Power on to Vout regulated			10	mS
Startup Time	Remote ON to Vout regulated			10	mS
Dynamic Load Response	50-75-50% load step, settling time to within ±1% of Vout		150	300	µSec
Dynamic Load Peak Deviation	same as above		±150	±200	mV
FEATURES and OPTIONS					
Remote On/Off Control ④					
"N" suffix:					
Negative Logic, ON state	ON=Ground pin or external voltage	-0.8		1	Vdc
Negative Logic, OFF state	OFF=Pin open or external voltage	2.5		13.5	Vdc
Control Current	sinking		1	2	mA
"P" suffix:					
Positive Logic, ON state	ON=Pin open or external voltage	2.5		13.5	V
Positive Logic, OFF state	OFF=Ground pin or external voltage	-0.8		1	V
Control Current	sinking		1	2	mA
Base Plate	"B" suffix		optional		
Conformal Coating	"H" suffix		optional		

FUNCTIONAL SPECIFICATIONS, UEE-3.3/30-D48 (CONT.)

OUTPUT	Conditions ①	Minimum	Typical/Nominal	Maximum	Units
Total Output Power		0.0	99	100	W
Voltage					
Nominal Output Voltage	No trim	3.267	3.30	3.333	Vdc
Setting Accuracy	At 50% load	-1		+1	% of Vset.
Output Voltage Range	User-adjustable	-10		+10	% of Vnom.
Overvoltage Protection	Via magnetic feedback	3.7	4	4.9	Vdc
Current					
Output Current Range		0.0	30.0	30.0	A
Minimum Load			No minimum load		
Current Limit Inception	98% of Vnom., after warmup	35	42	49	A
Short Circuit					
Short Circuit Current	Hiccup technique, autorecovery within $\pm 1.25\%$ of Vout		3	4	A
Short Circuit Duration (remove short for recovery)	Output shorted to ground, no damage		Continuous		
Short circuit protection method	Current limiting		Yes		
Regulation					
Line Regulation	Vin=min. to max., Vout=nom., Iout=nom.			± 0.1	% of Vout
Load Regulation	Iout=min. to max., Vin=48V			± 0.2	% of Vout
Ripple and Noise ②	5 Hz - 20 MHz BW		30	60	mV pk-pk
Temperature Coefficient	At all outputs		0.02		% of Vout./°C
Maximum Capacitive Loading	Cap. ESR= $<0.02\Omega$, full resistive load	0		10,000	μF
Remote Sense Compliance	Sense connected at load			10	% of Vout
MECHANICAL (Through Hole Models)					
Outline Dimensions (no baseplate)	C56 case		2.3x0.9x0.40 max.		Inches
(Please refer to outline drawing)	WxLxH		58.4x22.9x10.16		mm
Outline Dimensions (with baseplate)			2.3x0.9x0.50		Inches
			58.4x22.9x12.7		mm
Weight	No baseplate		1.09		Ounces
	No baseplate		31		Grams
	With baseplate		TBD		Ounces
	With baseplate		TBD		Grams
Through Hole Pin Diameter			0.04 & 0.062		Inches
			1.016&1.524		mm
Through Hole Pin Material			Copper alloy		
TH Pin Plating Metal and Thickness	Nickel subplate		100-299		μ -inches
	Gold overplate		10-31		μ -inches
Baseplate Material			Aluminum		
ENVIRONMENTAL					
Operating Ambient Temperature Range	No Derating, 100 LFM, full power, vertical mount	-40		85	°C
Operating Case Temperature	No derating	-40		125	°C
Storage Temperature	Vin = Zero (no power)	-55		125	°C
Thermal Protection/Shutdown	Measured in center	115	125	135	°C
Electromagnetic Interference	External filter is required				
Conducted, EN55022/CISPR22			B		Class
Radiated, EN55022/CISPR22			B		Class
Relative humidity, non-condensing	To +85°C	10		90	%RH
Altitude	must derate -1%/1000 feet	-500		10,000	feet
		-152		3048	meters
RoHS rating			RoHS-6		

Notes

- Unless otherwise noted, all specifications are at nominal input voltage, nominal output voltage and full load.
General conditions are +25° Celsius ambient temperature, near sea level altitude, natural convection airflow.
All models are tested and specified with external parallel 1 μF and 10 μF multi-layer ceramic output capacitors.
No external input capacitor is used. All capacitors are low-ESR types wired close to the converter. These capacitors are necessary for our test equipment and may not be needed in the user's application.
- Input (back) ripple current is tested and specified over 5 Hz to 20 MHz bandwidth. Input filtering is Cbus=220 μF , Cin=33 μF and Lbus=12 μH .
- All models are stable and regulate to specification under no load.
- The Remote On/Off Control is referred to -Vin. For external transistor control, use open collector logic or equivalent.

- NOTICE**—Please use only this customer data sheet as product documentation when laying out your printed circuit boards and applying this product into your application. Do NOT use other materials as official documentation such as advertisements, product announcements, or website graphics. We strive to have all technical data in this customer data sheet highly accurate and complete. This customer data sheet is revision-controlled and dated. The latest customer data sheet revision is normally on our website (www.murata-ps.com) for products which are fully released to Manufacturing. Please be especially careful using any data sheets labeled "Preliminary" since data may change without notice. The pinout (Pxx) and case (Cxx) designations (typically P32 or C56) refer to a generic family of closely related information. It may not be a single pinout or unique case outline. Please be aware of small details which may affect your application and PC board layouts. Study the Mechanical Outline drawings, Input/Output Connection table and all footnotes very carefully. Please contact Murata Power Solutions if you have any questions.

TYPICAL PERFORMANCE DATA AND OSCILLOGRAMS, UEE-3.3/30-D48

UEE-3.3/30-D48 Efficiency and Power Dissipation @ Ta = +25°C

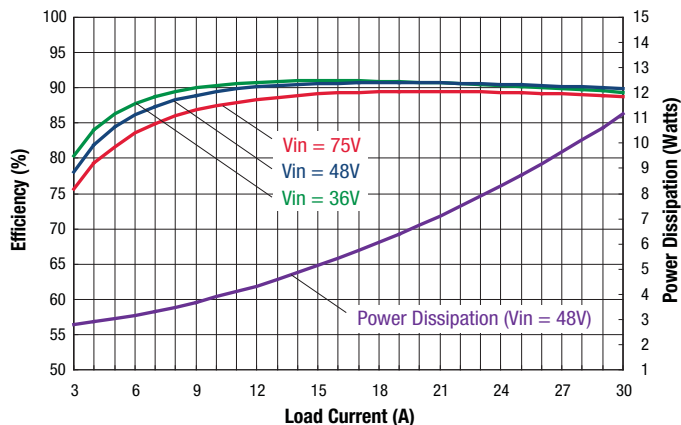

UEE-3.3/30-D48 Maximum Current Temperature Derating at Sea Level (Vin = 48V, no baseplate. Airflow direction is longitudinal, from Vin to Vout.)

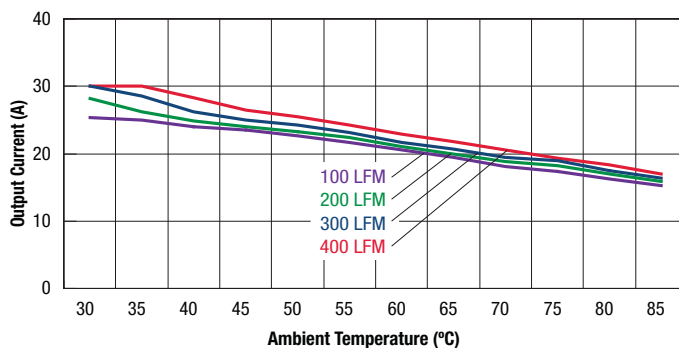

UEE-3.3/30-D48 Maximum Current Temperature Derating at Sea Level (Vin = 48V, with baseplate. Airflow direction is from Vin to Vout.)

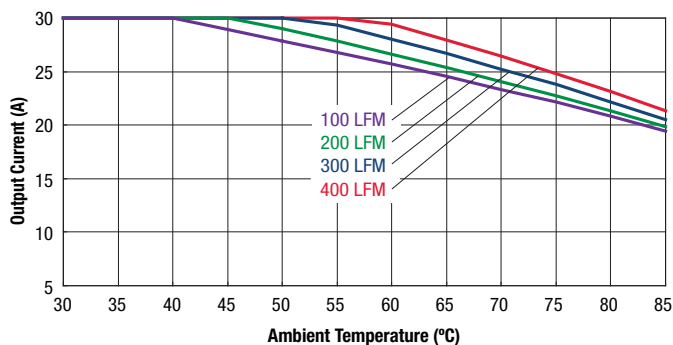

UEE-3.3/30-D48 Maximum Current Temperature Derating at Sea Level (Vin = 48V, with baseplate. Airflow direction is transverse from +Vin to -Vin.)

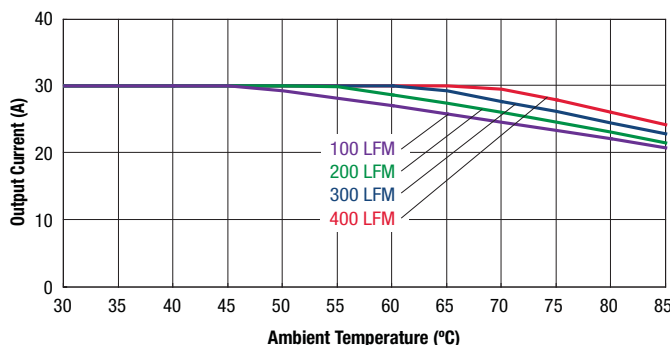

UEE-3.3/30-D48 Maximum Current Temperature Derating at Sea Level (Vin = 48V, no baseplate. Airflow direction is transverse.)

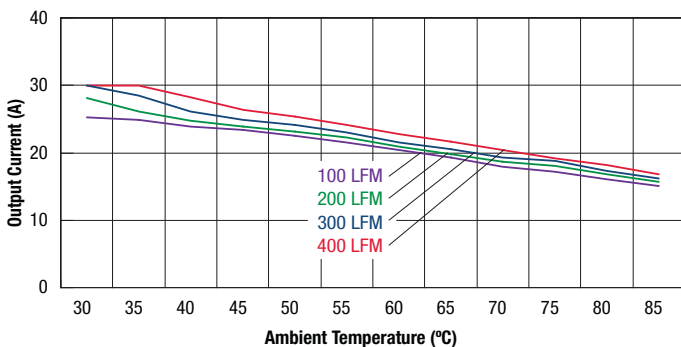

Step Load Transient Response (Slew=1A / μSec., Vin=48V., Load=0, Iout=15A to 22.5A)

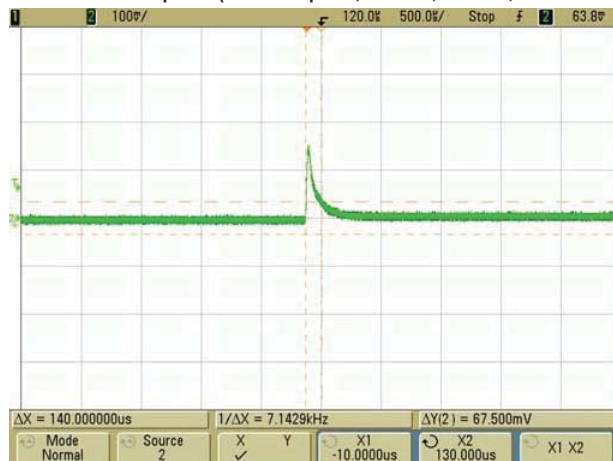

TYPICAL PERFORMANCE DATA AND OSCILLOGRAMS, UEE-3.3/30-D48

Step Load Transient Response (Slew=1A / μ Sec., Vin=48V, Vout=nom., Iout=22.5A to 15A)

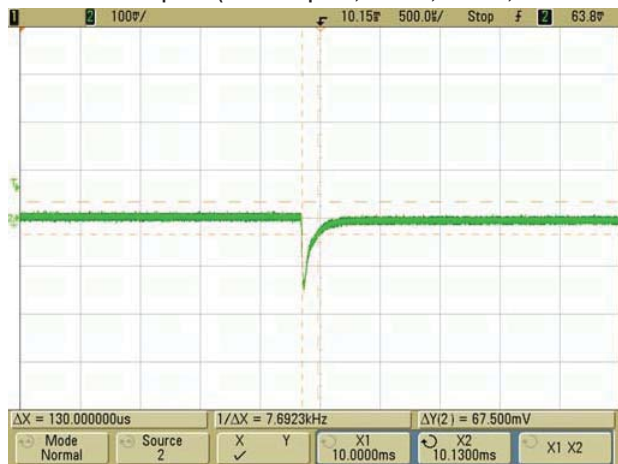

On/Off Enable Delay (Vin=48V, Vout=nom., Iout=30A, Cload=0, Ta=+25° C., ScopeBW=20Mhz, Trace 2=Vout, Trace 4=Enable.)

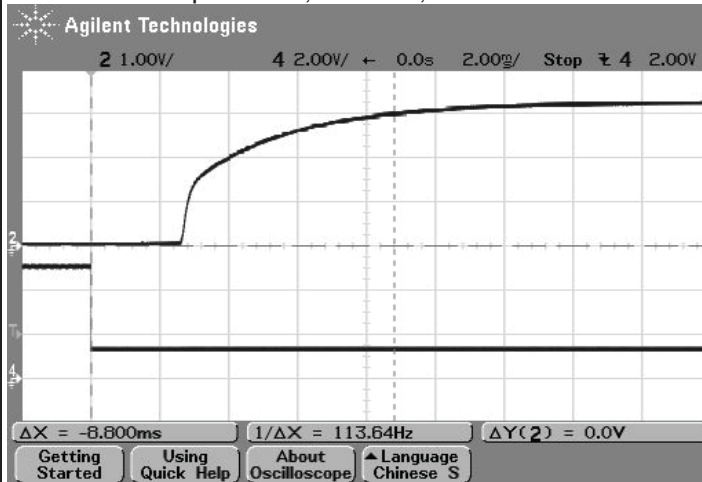

On/Off Enable Delay (Vin=48V, Vout=nom., Iout=0A, Cload=0, Ta=+25° C., ScopeBW=20Mhz, Trace 2=Vout, Trace 4=Enable.)

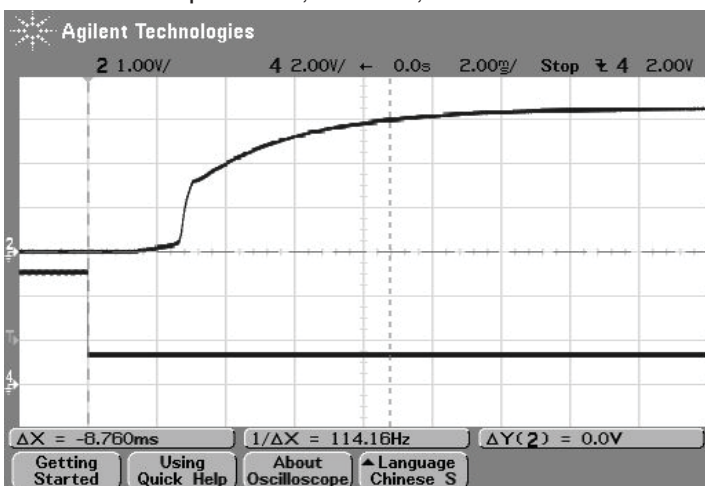

On/Off Enable Delay (Vin=48V, Vout=nom., Iout=30A, Cload=10uF, Ta=+25° C., ScopeBW=20Mhz, Trace 2=Vout, Trace 4=Enable.)

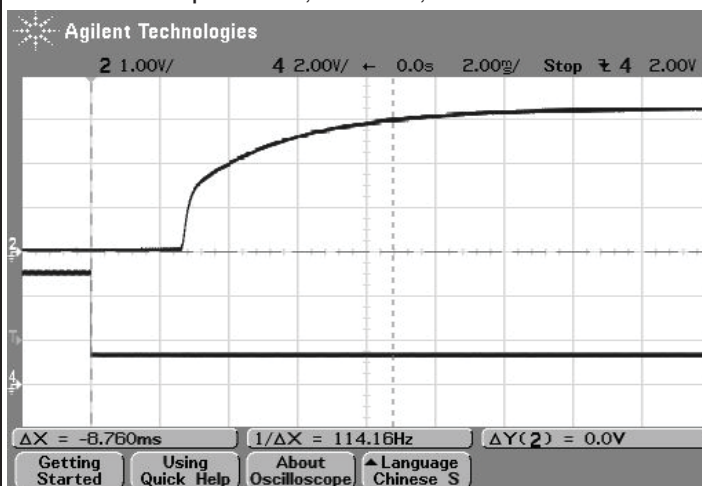

Output Ripple and noise (Vin=48V, Vout=nom., Iout=30A, Cload=0, Ta=+25° C., ScopeBW=20Mhz)

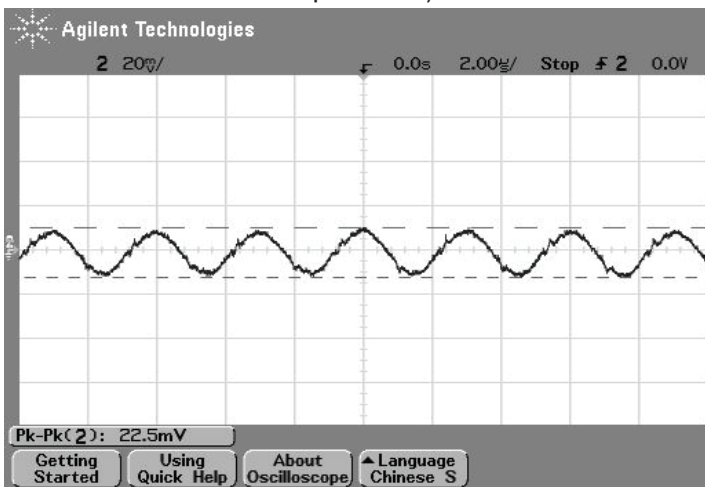

Output Ripple and noise (Vin=48V, Vout=nom., Iout=30A, Cload=0, Ta=+25° C., ScopeBW=20Mhz)

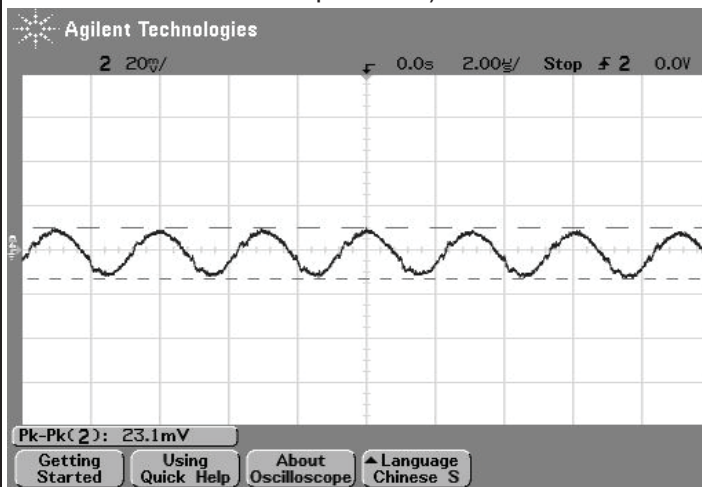

TYPICAL PERFORMANCE DATA AND OSCILLOGRAMS, UEE-3.3/30-D48

Thermal image with hot spot at full load current with 85 °C ambient; air is flowing at 200 LFM. Air is flowing across the converter from Vin to Vout at 48V input. Identifiable and recommended maximum value to be verified in application.
T1 & Q1, Max temp= 120 °C/IPC9592 derating guidelines.

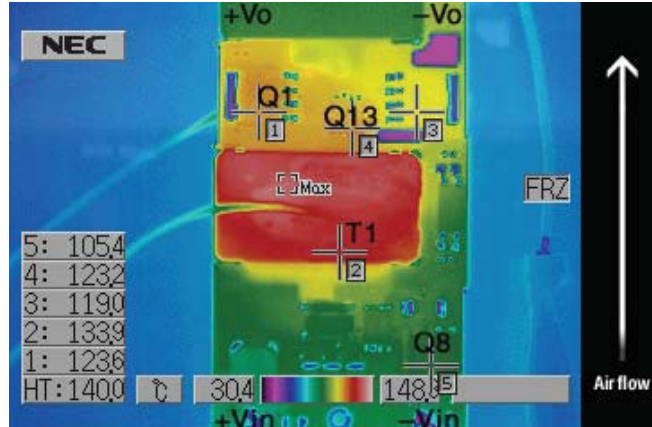

Isolated, High-Density, Eighth-Brick
DOSA Low Profile DC-DC Converters

Emissions Performance, Model UEE-3.3/30-D48

Murata Power Solutions measures its products for radio frequency emissions against the EN 55022 and CISPR 22 standards. Passive resistance loads are employed and the output is set to the maximum voltage. If you set up your own emissions testing, make sure the output load is rated at continuous power while doing the tests.

The recommended external input and output capacitors (if required) are included. Please refer to the fundamental switching frequency. All of this information is listed in the Product Specifications. An external discrete filter is installed and the circuit diagram is shown below.

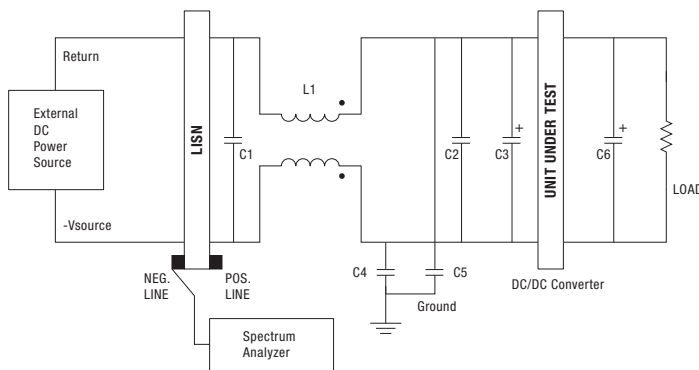

Figure 4. Conducted Emissions Test Circuit

[1] Conducted Emissions Parts List

Designation	Value	Part Number	Description	Vendor
C1	1 μ F	GRM32ER72A105KA01L	SMD Ceramic, 100V, 1000nF, X7R-1210	Murata
C2	100 nF	GRM319R72A104KA01D	SMD Ceramic, 100V, 100nF \pm 10%, X7R-1206	Murata
L1	1320 μ H	LB16H1324	Common Mode choke, 1320 μ H, \pm 25%, 4A, R5K, *21*21*12.5mm	High Light
C4, C5	0.022 μ F	GRM32DR73A223KW01L	SMD Ceramic, 1000V, 0.022 μ F, \pm 10%, X7R-1210	Murata
C3	220 μ F	UHE2A221MHD	Alum. electrolytic, 100V, 220 μ F, \pm 10%, long lead	Nichicon
C6	Not used		Not used for this model	

[2] Conducted Emissions Test Equipment Used

Spectrum Analyzer – Hewlett Packard HP8594L

Line Impedance Stabilization Network (LISN) – 2 Line V-Networks LS1-15V, 50 Ω , 50 μ H

[3] Conducted Emissions Test Results

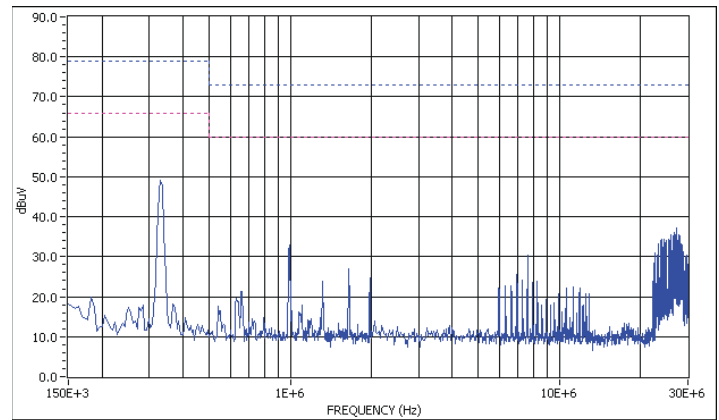

Peak Detection Value

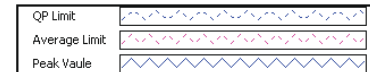

Graph 5. Conducted emissions performance, Positive Line, CISPR 22, Class A, full load

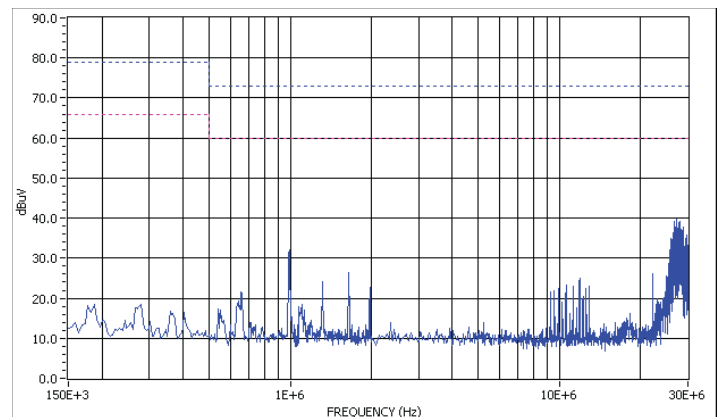

Peak Detection Value

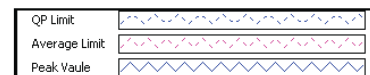

Graph 6. Conducted emissions performance, Negative Line, CISPR 22, Class A, full load

[4] Layout Recommendations

Most applications can use the filtering which is already installed inside the converter or with the addition of the recommended external capacitors. For greater emissions suppression, consider additional filter components and/or shielding. Emissions performance will depend on the user's PC board layout, the chassis shielding environment and choice of external components. Please refer to Application Note GEAN02 for further discussion.

Since many factors affect both the amplitude and spectra of emissions, we recommend using an engineer who is experienced at emissions suppression.

FUNCTIONAL SPECIFICATIONS, UEE-5/30-D48 (PRELIMINARY)

ABSOLUTE MAXIMUM RATINGS		Conditions ①	Minimum	Typical/Nominal	Maximum	Units
Input Voltage, Continuous			0		80	Vdc
Input Voltage, Transient		100 mS max. duration			100	Vdc
Isolation Voltage		Input to output, continuous			2250	Vdc
On/Off Remote Control		Power on, referred to -Vin	0		15	Vdc
Output Power			0		152.25	W
Output Current		Current-limited, no damage, short-circuit protected	0		30	A
Storage Temperature Range		Vin = Zero (no power)	-55		125	°C
Absolute maximums are stress ratings. Exposure of devices to greater than any of these conditions may adversely affect long-term reliability. Proper operation under conditions other than those listed in the Performance/Functional Specifications Table is not implied or recommended.						
INPUT		Conditions ① ③				
Operating Voltage Range			36	48	75	Vdc
Recommended External Fuse		Fast blow			10	A
Start-Up Threshold		Rising input voltage	33	34	35	Vdc
Undervoltage Shutdown		Falling input voltage	32	33	34	Vdc
Overvoltage Shutdown				None		Vdc
Internal Filter Type				Pi		
Input Current						
Full Load Conditions		Vin = nominal		3.5	4	A
Low Line Input Current		Vin = minimum		4.5	5	A
Inrush Transient					0.5	A ² -Sec.
Short Circuit Input Current				1		A
No Load		Iout = minimum, unit = ON		100	120	mA
Shut-Down Input Current (Off, UV, OT)				6	10	mA
Reflected (back) ripple current ②		Measured at input with specified filter		50		mA, P-P
Pre-biased startup		External output voltage < Vset		Monotonic		
GENERAL and SAFETY						
Efficiency		Vin = 48V, full load	90	92		%
		Vin = min, full load	89	91		%
Isolation						
Isolation Voltage		Input to output, continuous	2250			Vdc
Isolation Voltage		Input to baseplate, continuous	1500			Vdc
Isolation Voltage		Output to baseplate, continuous	1500			Vdc
Insulation Safety Rating				basic		
Isolation Resistance				10		MΩ
Isolation Capacitance				1000		pF
Safety		Certified to UL-60950-1, CSA-C22.2 No.60950-1, IEC/EN60950-1, 2nd edition		Yes		
Calculated MTBF		Per Telcordia SR-332, issue 1, class 3, ground fixed, Tcase = +25°C		TBD		Hours x 10 ⁶
DYNAMIC CHARACTERISTICS						
Fixed Switching Frequency				400		KHz
Startup Time		Power on to Vout regulated		5	10	mS
Startup Time		Remote ON to Vout regulated		8	10	mS
Dynamic Load Response		50-75-50% load step, settling time to within ±1% of Vout			2500	µSec
Dynamic Load Peak Deviation		same as above			±450	mV
FEATURES and OPTIONS						
Remote On/Off Control ④						
"N" suffix:						
Negative Logic, ON state		ON = Ground pin or external voltage	-0.1		0.8	Vdc
Negative Logic, OFF state		OFF = Pin open or external voltage	2.5		15	Vdc
Control Current		Open collector/drain		1	2	mA
"P" suffix:						
Positive Logic, ON state		ON = Pin open or external voltage	3.5		15	V
Positive Logic, OFF state		OFF = Ground pin or external voltage	0		1	V
Control Current		Open collector/drain		1	2	mA
Remote Sense		Sense connected to load		10		%
Base Plate		"B" suffix		optional		
SMT Mounting		"M" suffix		optional		

FUNCTIONAL SPECIFICATIONS, UEE-5/30-D48 (CONT.) (PRELIMINARY)

OUTPUT	Conditions ①	Minimum	Typical/Nominal	Maximum	Units
Total Output Power	See Derating	147.75	150	152.25	W
Voltage					
Nominal Output Voltage	No trim	4.925	5	5.075	Vdc
Setting Accuracy	At 50% load, no trim	-1.5		1.5	% of Vnom
Output Voltage Range	User-adjustable	-20		10	% of Vnom.
Overvoltage Protection	Via magnetic feedback	6	6.5	7.5	Vdc
Current					
Output Current Range		0	30	30	A
Current Limit Inception	98% of Vnom., after warmup	35	40	44	A
Short Circuit					
Short Circuit Current	Hiccup technique, autorecovery within $\pm 1.25\%$ of Vout		5		A
Short Circuit Duration (remove short for recovery)	Output shorted to ground, no damage		Continuous		
Short circuit protection method	Current limiting		Yes		
Regulation					
Line Regulation	Vin = min. to max., Vout = nom., Iout = nom.			± 0.1	% of Vout
Load Regulation	Iout = min. to max., Vin = 48V			± 0.1	% of Vout
Ripple and Noise ②	5 Hz- 20 MHz BW		50	80	mV pk-pk
Temperature Coefficient	At all outputs			0.02	% of Vout./°C
Maximum Capacitive Loading	Low ESR, resistive load only			10000	μ F
MECHANICAL (Through Hole Models)					
Outline Dimensions			2.3x0.9x0.40		Inches
(Please refer to outline drawing)	LxWxH		58.42x22.86x10.16		mm
Weight	No baseplate		1.09		Ounces
			31		Grams
	With baseplate		tbd		Ounces
			tbd		Grams
Through Hole Pin Diameter			0.04 & 0.062		Inches
			1.016 & 1.575		mm
Through Hole Pin Material			Copper alloy		
TH Pin Plating Metal and Thickness	Nickel subplate		100-299		μ -inches
	Gold overplate		10-31		μ -inches
ENVIRONMENTAL					
Operating Ambient Temperature Range	With Derating	-40		85	°C
Operating Case Temperature Range	No derating.	-40		115	°C
Storage Temperature	Vin = Zero (no power)	-55		125	°C
Thermal Protection/Shutdown	Measured in center	115	125	130	°C
Electromagnetic Interference	External filter is required				
Conducted, EN55022/CISPR22			B		Class
RoHS rating			RoHS-6		

Notes

- ① Unless otherwise noted, all specifications are at nominal input voltage, nominal output voltage and full load.
General conditions are +25° Celsius ambient temperature, near sea level altitude, natural convection airflow.
All models are tested and specified with external parallel 1 μ F and 10 μ F multi-layer ceramic output capacitors.
A 220 μ F external input capacitor is used. All capacitors are low-ESR types wired close to the converter. These capacitors are necessary for our test equipment and may not be needed in the user's application.
- ② Input (back) ripple current is tested and specified over 5 Hz to 20 MHz bandwidth. Input filtering is Cbus=220 μ F, Cin=33 μ F and Lbus=12 μ H.
- ③ All models are stable and regulate to specification under no load.
- ④ The Remote On/Off Control is referred to -Vin. For external transistor control, use open collector logic or equivalent.

- ⑤ NOTICE—Please use only this customer data sheet as product documentation when laying out your printed circuit boards and applying this product into your application. Do NOT use other materials as official documentation such as advertisements, product announcements, or website graphics.
We strive to have all technical data in this customer data sheet highly accurate and complete. This customer data sheet is revision-controlled and dated. The latest customer data sheet revision is normally on our website (www.murata-ps.com) for products which are fully released to Manufacturing. Please be especially careful using any data sheets labeled "Preliminary" since data may change without notice. The pinout (Pxx) and case (Cxx) designations (typically P32 or C56) refer to a generic family of closely related information. It may not be a single pinout or unique case outline. Please be aware of small details which may affect your application and PC board layouts. Study the Mechanical Outline drawings, Input/Output Connection table and all footnotes very carefully. Please contact Murata Power Solutions if you have any questions.

TYPICAL PERFORMANCE DATA AND OSCILLOGRAMS, UEE-5/30-D48 (PRELIMINARY)

Efficiency vs. Line Voltage and Load Current @ +25°C

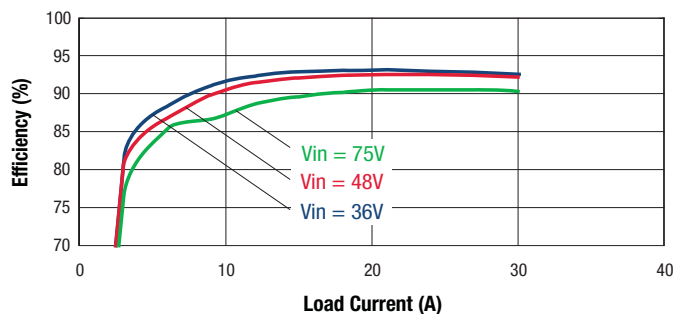

Maximum Current Temperature Derating at Sea Level
(Vin = 36V, no baseplate. Airflow Direction Is Transverse from -Vin to +Vin.)

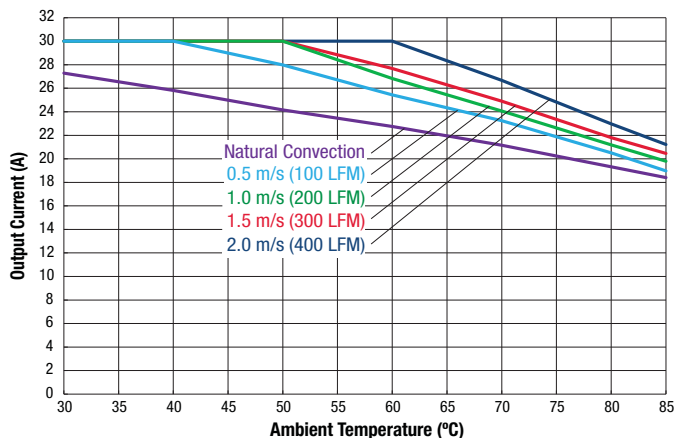

Maximum Current Temperature Derating at Sea Level
(Vin = 48V, no baseplate. Airflow Direction Is Transverse from -Vin to +Vin.)

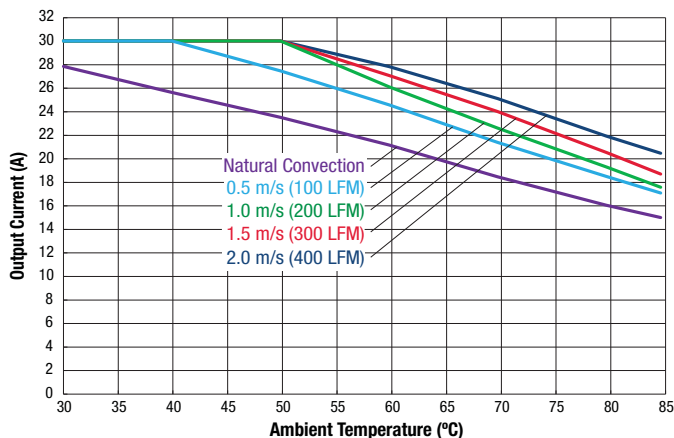

Maximum Current Temperature Derating at Sea Level
(Vin = 36V, no baseplate. Airflow Direction Is Longitudinal from -Vin to +Vin.)

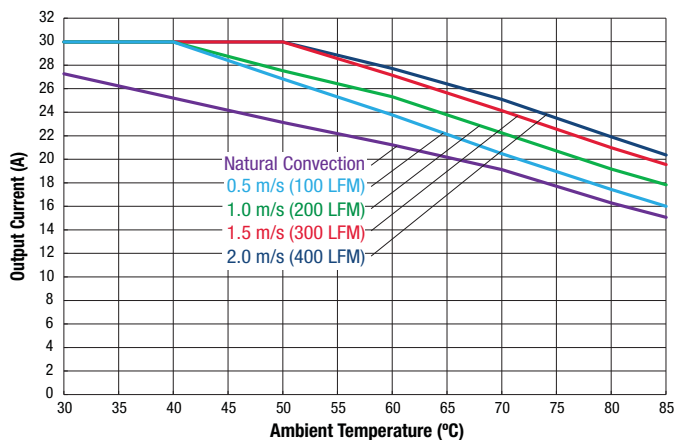

Maximum Current Temperature Derating at Sea Level
(Vin = 36V, no baseplate. Airflow Direction Is Longitudinal from -Vin to +Vin.)

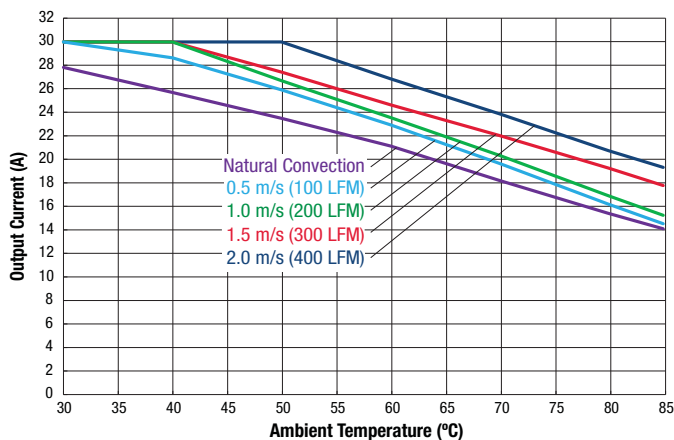

Isolated, High-Density, Eighth-Brick
DOSA Low Profile DC-DC Converters

TYPICAL PERFORMANCE DATA AND OSCILLOGRAMS, UEE-5/30-D48 (PRELIMINARY)

Step Load Transient Response ($V_{in} = 48V$, $V_{out} = \text{nom}$, $C_{load} = 1\mu F \parallel 10\mu F$,
 $I_{out} = 75\% \text{ to } 50\% \text{ of full load}$, $T_a = +25^\circ C$) Ch1 = Vout, Ch2 = Iout

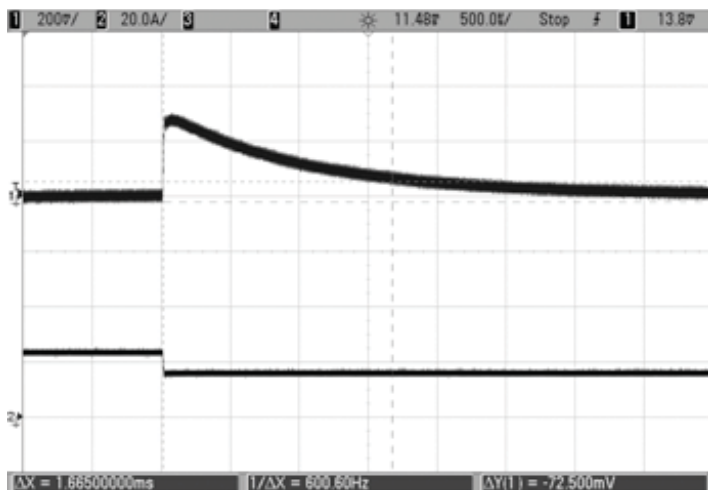

Step Load Transient Response ($V_{in} = 48V$, $V_{out} = \text{nom}$, $C_{load} = 1\mu F \parallel 10\mu F$,
 $I_{out} = 50\% \text{ to } 75\% \text{ of full load}$, $T_a = +25^\circ C$) Ch1 = Vout, Ch2 = Iout

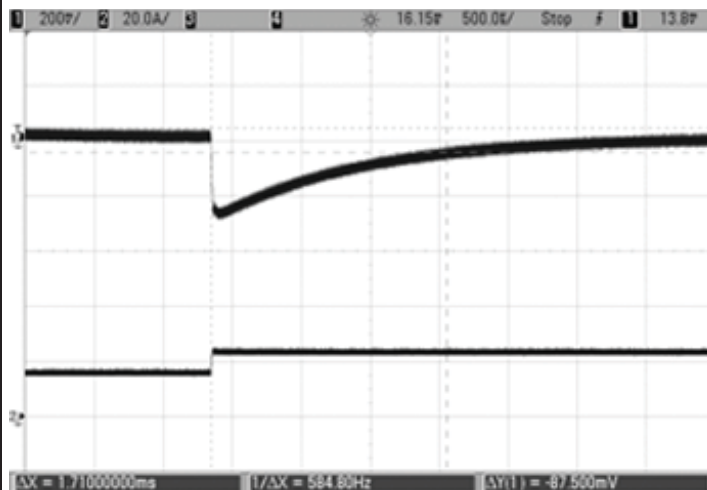

Step Load Transient Response ($V_{in} = 48V$, $V_{out} = \text{nom}$, $C_{load} = 1\mu F \parallel 10\mu F$,
 $I_{out} = 50 \text{ to } 75 \text{ to } 50\% \text{ of full load}$, $T_a = +25^\circ C$) Ch1 = Vout, Ch2 = Iout.



Isolated, High-Density, Eighth-Brick
DOSA Low Profile DC-DC Converters

TYPICAL PERFORMANCE DATA AND OSCILLOGRAMS, UEE-5/30-D48 (PRELIMINARY)

Enable Start Up Delay (Vin = 48V, Vout = nom, Iout = 30A, Cload = 10000uF, Ta = +25°C)
Ch2 = Vout, Ch4 = Enable.

Vin Start Up Delay (Vin = 48V, Vout = nom, Iout = 30A, Cload = 10000uF, Ta = +25°C)
Ch2 = Vout, Ch4 = Enable.

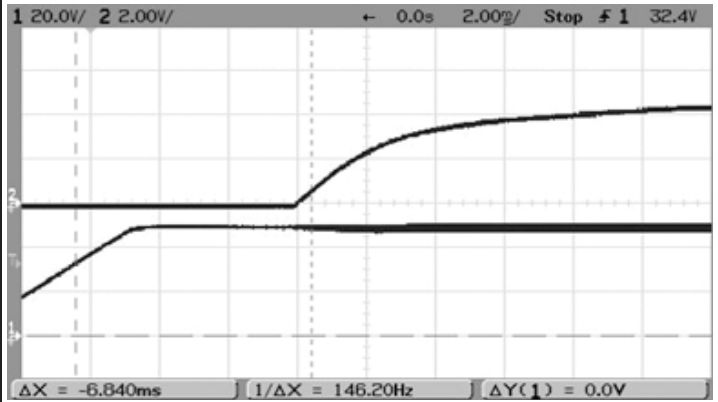
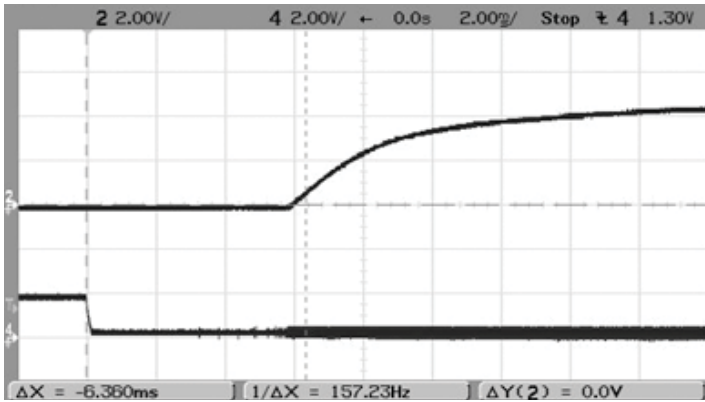

Output Ripple and noise (Vin = 48V, Vout = nom, Iout = 0A, Cload = 1uF || 10uF,
Ta = +25°C, ScopeBW = 20Mhz)

Output Ripple and noise (Vin = 48V, Vout = nom, Iout = 30A, Cload = 1uF || 10uF,
Ta = +25°C, ScopeBW = 20Mhz)

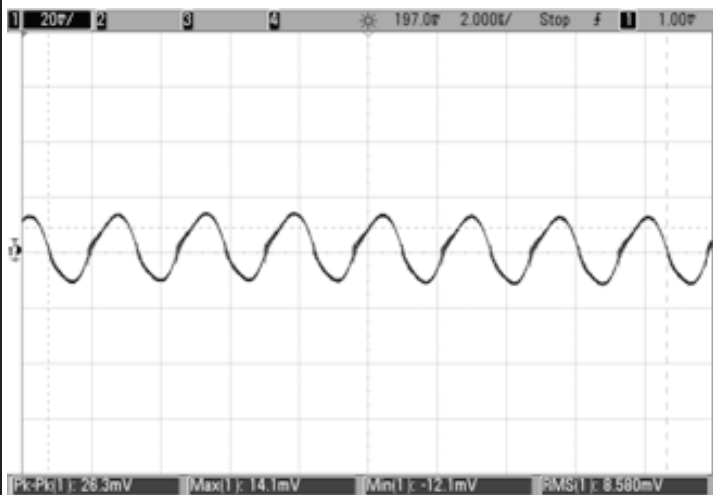
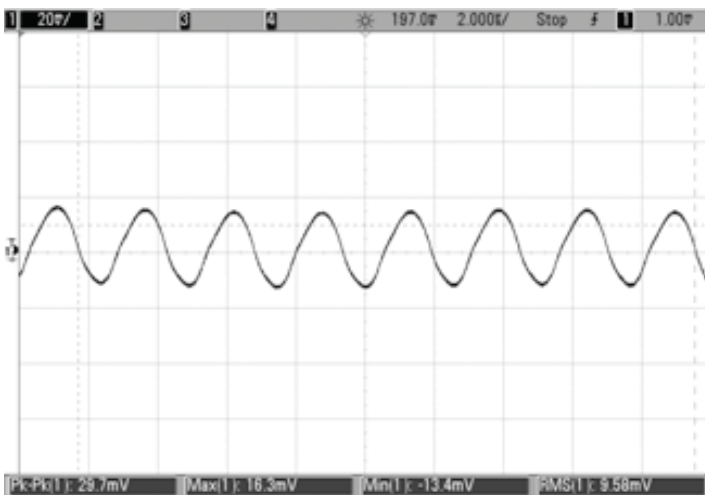

Isolated, High-Density, Eighth-Brick
DOSA Low Profile DC-DC Converters

Emissions Performance, Model UEE-5/30-D48 (PRELIMINARY)

Murata Power Solutions measures its products for radio frequency emissions against the EN 55022 and CISPR 22 standards. Passive resistance loads are employed and the output is set to the maximum voltage. If you set up your own emissions testing, make sure the output load is rated at continuous power while doing the tests.

The recommended external input and output capacitors (if required) are included. Please refer to the fundamental switching frequency. All of this information is listed in the Product Specifications. An external discrete filter is installed and the circuit diagram is shown below.

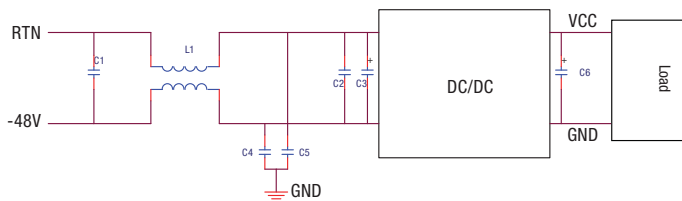

Figure 5. Conducted Emissions Test Circuit

[1] Conducted Emissions Parts List

[2] Conducted Emissions Test Equipment Used

Spectrum Analyzer – Hewlett Packard HP8594L

Line Impedance Stabilization Network (LISN) – 2 Line V-Networks LS1-15V, 50 Ω, 50 μH

Designation	Value	Part Number	Description	Vendor
C1	1 μF	GRM32ER72A105KA01L	SMD Ceramic, 100V, 1000nF, X7R-1210	Murata
C2	100 nF	GRM319R72A104KA01D	SMD Ceramic, 100V, 100nF ±10%, X7R-1206	Murata
L1	1320 μH	LB16H1324	Common Mode choke, 1320 μH, ±25%, 4A, R5K, *21*21*12.5mm	High Light
C4, C5	0.022 μF	GRM32DR73A223KW01L	SMD Ceramic, 1000V, 0.022 μF, ±10%, X7R-1210	Murata
C3	220 μF	UHE2A221MHD	Alum. electrolytic, 100V, 220 μF, ±10%, long lead	Nichicon
C6	Not used		Not used for this model	

[3] Conducted Emissions Test Results

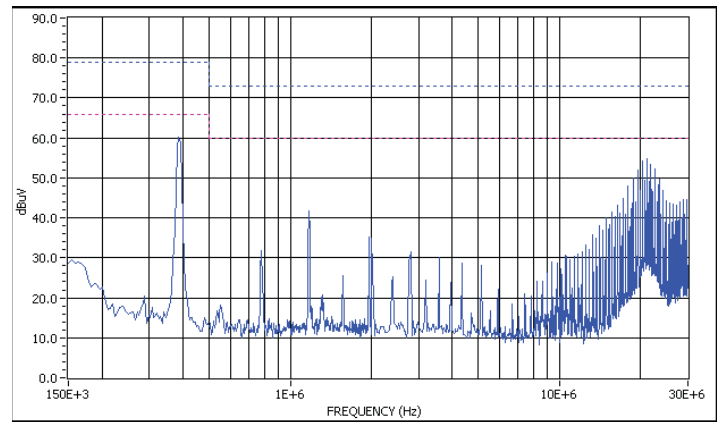

Peak Detection Value

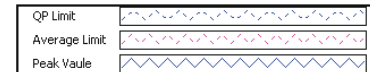

Graph 7. Conducted emissions performance, Positive Line, CISPR 22, Class A, 48 Vin, full load

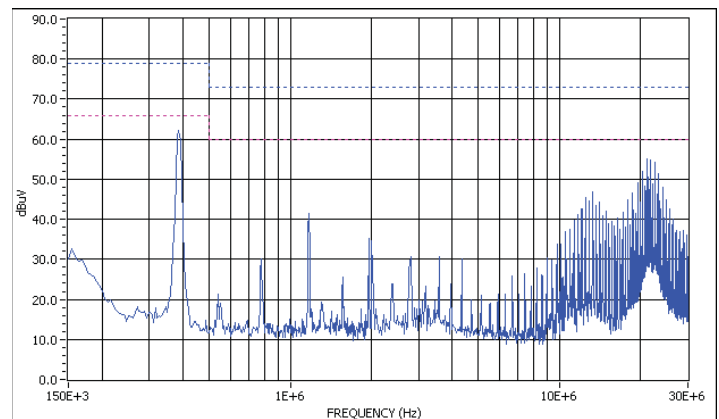

Peak Detection Value

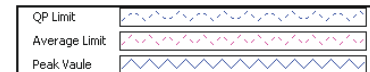

Graph 8. Conducted emissions performance, Negative Line, CISPR 22, Class A, 48 Vin, full load

[4] Layout Recommendations

Most applications can use the filtering which is already installed inside the converter or with the addition of the recommended external capacitors. For greater emissions suppression, consider additional filter components and/or shielding. Emissions performance will depend on the user's PC board layout, the chassis shielding environment and choice of external components. Please refer to Application Note GEAN02 for further discussion.

Since many factors affect both the amplitude and spectra of emissions, we recommend using an engineer who is experienced at emissions suppression.

MECHANICAL SPECIFICATIONS (THROUGH-HOLE MOUNT)

TOP VIEW

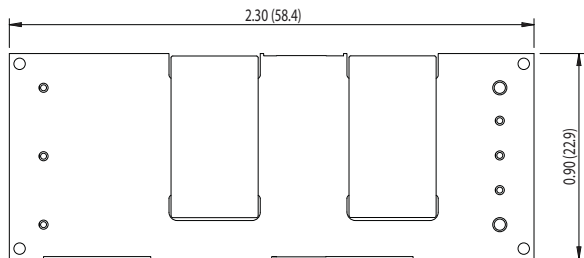

Package C56

TOP VIEW

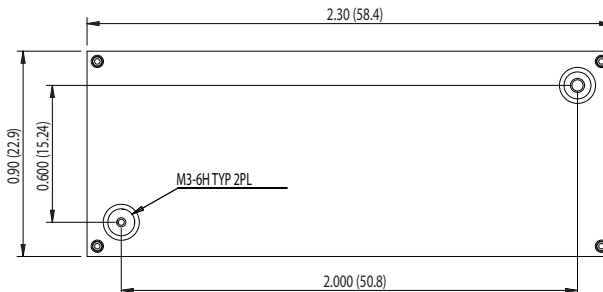

OPEN FRAME (NO BASEPLATE)

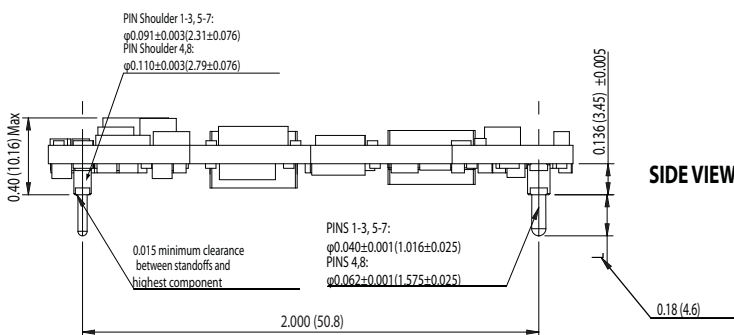

SIDE VIEW

**WITH BASEPLATE OPTION
(Baseplate not available for UEE-3.3/15-D48 models.)**

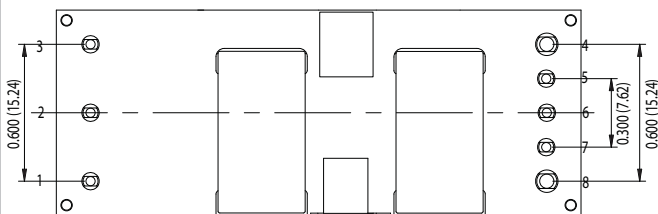
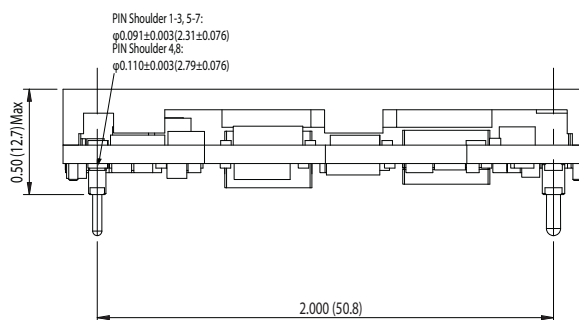

BOTTOM PIN SIDE VIEW

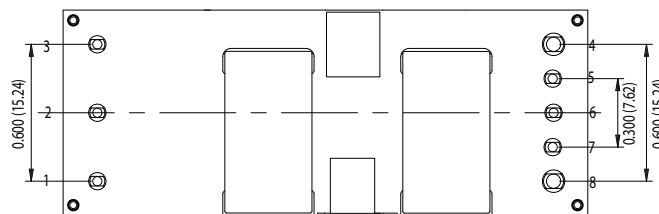

BOTTOM PIN SIDE VIEW

- ① M3 bolts must not exceed 0.118" (3.0mm) depth below the baseplate surface.
- ② Applied screw torque must not exceed 5.3 in-lb. (0.6 N-m).

Typical clearance to on-board components is 0.015" (0.38mm). In general, the user should not place components directly below the converter.

Standard pin length is shown. Please refer to the part number structure for alternate pin lengths.

**DOSA-Compatible
INPUT/OUTPUT CONNECTIONS**

Pin	Function P32
1	Positive Input
2	On/Off Control
3	Negative Input
4	Negative Output
5	Negative Sense
6	Output Trim
7	Positive Sense
8	Positive Output

Dimensions are in inches (mm shown for ref. only).

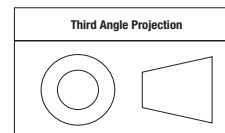

Tolerances (unless otherwise specified):
 .XX ± 0.02 (0.5)
 .XXX ± 0.010 (0.25)
 Angles ± 2°

Components are shown for reference only and may vary between units.

MECHANICAL SPECIFICATIONS (SURFACE MOUNT, MSL Rating 2a)

SIDE VIEW, OPEN FRAME

Package C56

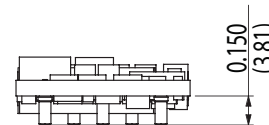
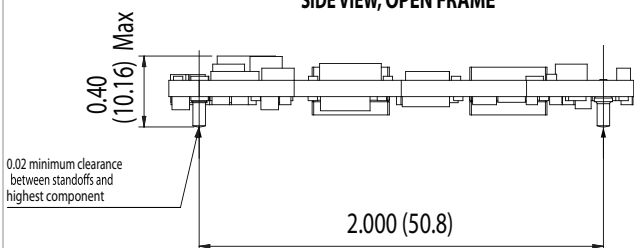

BOTTOM PIN VIEW

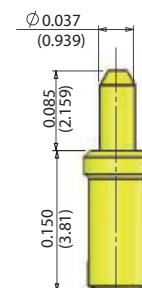
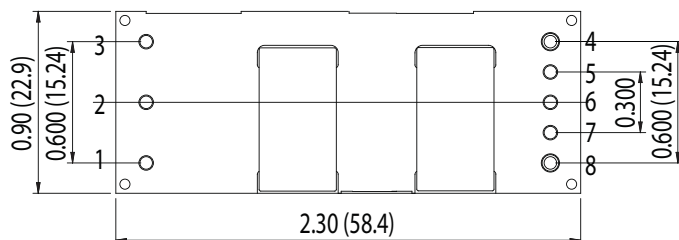

FINISH: UNDERPLATE WITH 2.54 μm MIN AND 7.6 μm MAX OF NICKEL,
OVERPLATE WITH 0.10 μm MIN AND 0.30 μm Max OF GOLD.

RECOMMENDED PAD LAYOUT (SMD)

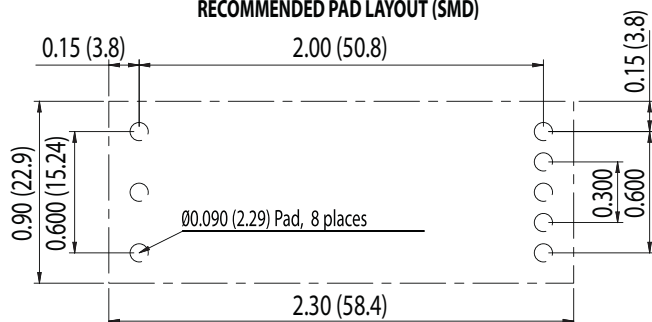

Do not place components directly below the converter.

DOSA-Compatible INPUT/OUTPUT CONNECTIONS	
Pin	Function P32
1	Positive Input
2	On/Off Control
3	Negative Input
4	Negative Output
5	Negative Sense
6	Output Trim
7	Positive Sense
8	Positive Output

Dimensions are in inches (mm shown for ref. only).

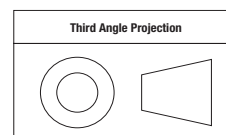

Tolerances (unless otherwise specified):
.XX ± 0.02 (0.5)
.XXX ± 0.010 (0.25)
Angles ± 2°

Components are shown for reference only
and may vary between units.

SHIPPING TRAYS AND BOXES (THROUGH-HOLE MOUNT)

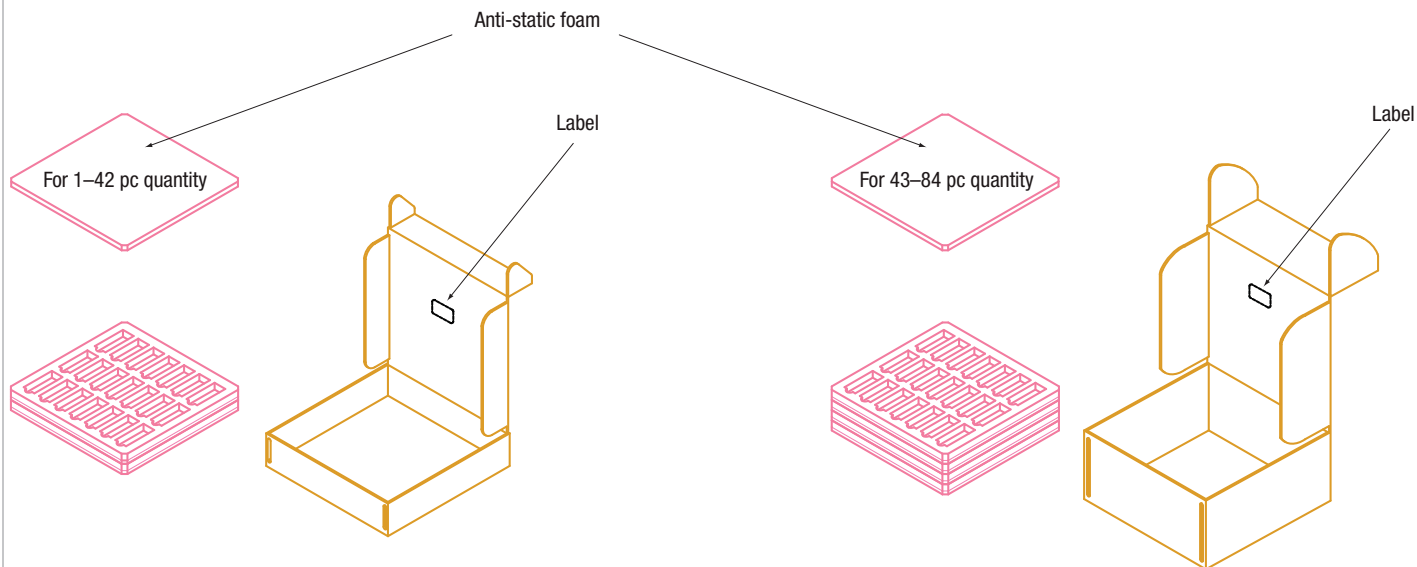

SHIPPING TRAY (THROUGH-HOLE MOUNT)

UEE through-hole modules are supplied in a 21-piece (3-by-7) shipping tray. The tray is an anti-static closed-cell polyethylene foam. Dimensions are shown below.

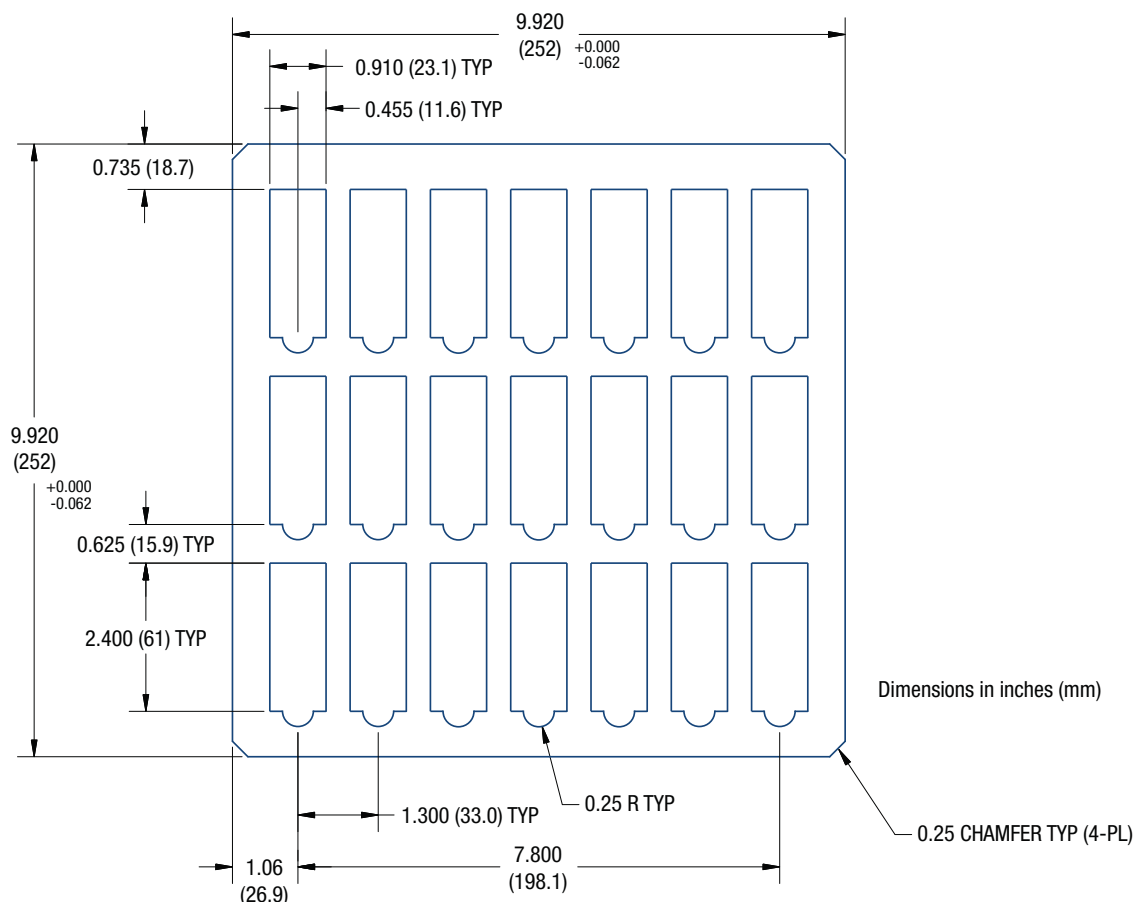

TAPE AND REEL INFORMATION (SURFACE MOUNT, MSL Rating 2a)

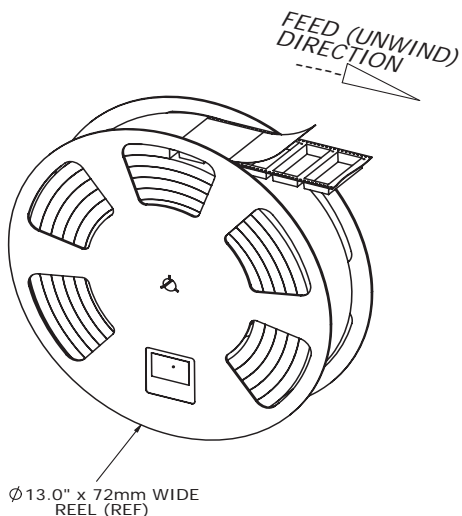

Reel Information
(100 units per reel)

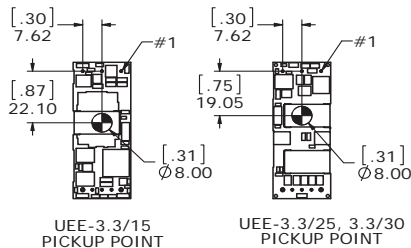
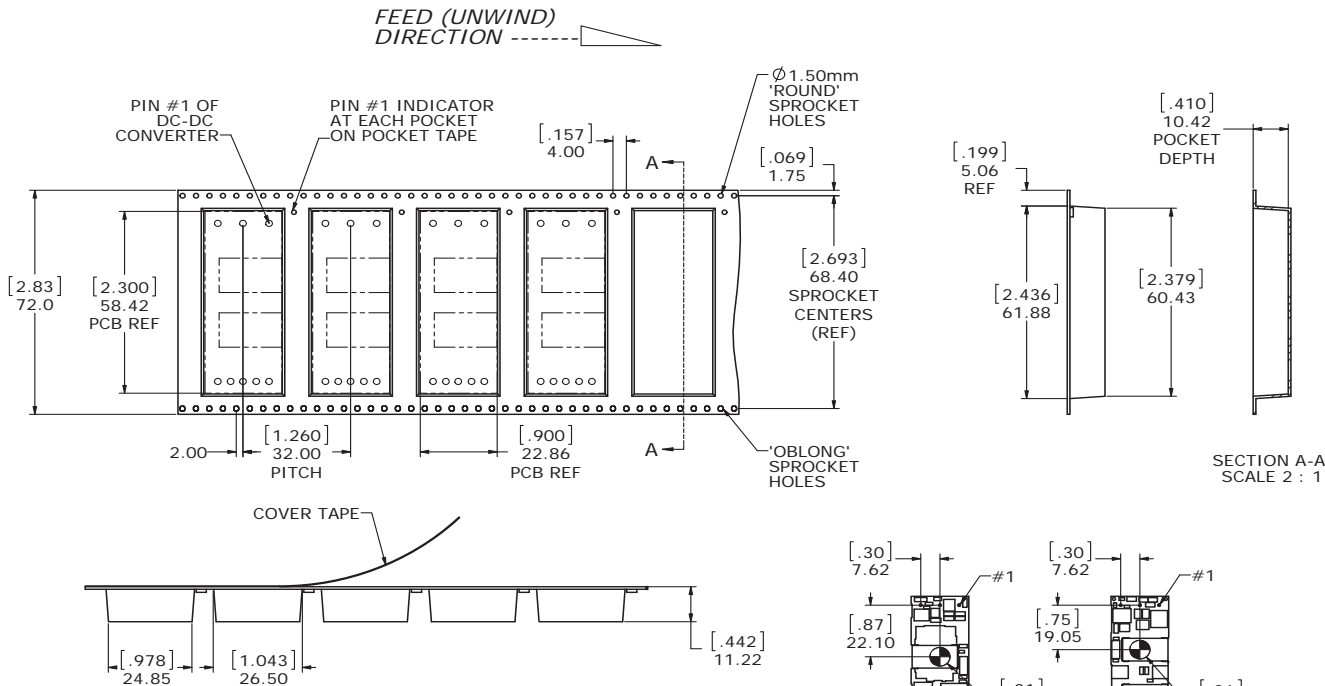
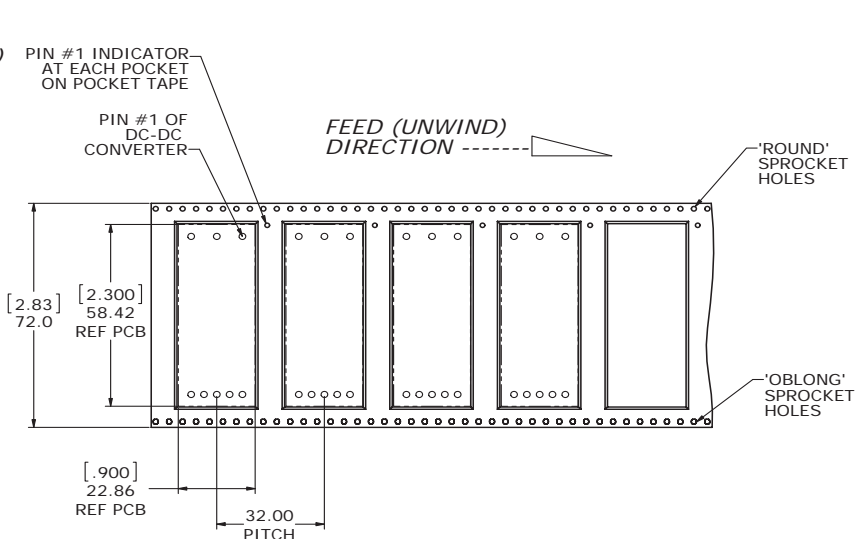

TECHNICAL NOTES

THROUGH-HOLE SOLDERING GUIDELINES

Murata Power Solutions recommends the specifications below when installing these converters. These specifications vary depending on the solder type. Exceeding these specifications may cause damage to the product. Your production environment may differ; therefore please thoroughly review these guidelines with your process engineers.

Wave Solder Operations for through-hole mounted products (THMT)

For Sn/Ag/Cu based solders:

Maximum Preheat Temperature	115°C.
Maximum Pot Temperature	270°C.
Maximum Solder Dwell Time	7 seconds

For Sn/Pb based solders:

Maximum Preheat Temperature	105°C.
Maximum Pot Temperature	250°C.
Maximum Solder Dwell Time	6 seconds

Input Fusing

Certain applications and/or safety agencies may require fuses at the inputs of power conversion components. Fuses should also be used when there is the possibility of sustained input voltage reversal which is not current-limited. For greatest safety, we recommend a fast blow fuse installed in the ungrounded input supply line with a value which is approximately twice the maximum line current, calculated at the lowest input voltage.

The installer must observe all relevant safety standards and regulations. For safety agency approvals, install the converter in compliance with the end-user safety standard.

Input Reverse-Polarity Protection

If the input voltage polarity is reversed, an internal body diode will become forward biased and likely draw excessive current from the power source. If this source is not current-limited or the circuit appropriately fused, it could cause permanent damage to the converter. **Please be sure to install a properly rated external input fuse.**

Input Under-Voltage Shutdown and Start-Up Threshold

Under normal start-up conditions, converters will not begin to regulate properly until the rising input voltage exceeds and remains at the Start-Up Threshold (see Specifications). Once operating, converters will not turn off until the input voltage drops below the Under-Voltage Shutdown Limit. Subsequent

SMT REFLOW SOLDERING GUIDELINES

The surface-mount reflow solder profile shown below is suitable for SAC305 type lead-free solders. This graph should be used only as a **guideline**. Many other factors influence the success of SMT reflow soldering. Since your production environment may differ, please thoroughly review these guidelines with your process engineers.

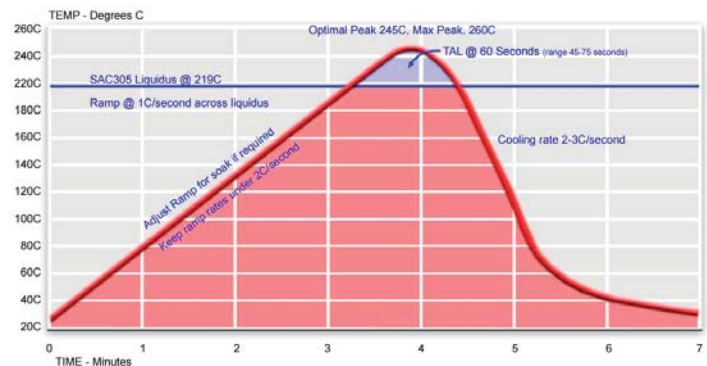

restart will not occur until the input voltage rises again above the Start-Up Threshold. This built-in hysteresis prevents any unstable on/off operation at a single input voltage.

Users should be aware however of input sources near the Under-Voltage Shutdown whose voltage decays as input current is consumed (such as capacitor inputs), the converter shuts off and then restarts as the external capacitor recharges. Such situations could oscillate. To prevent this, make sure the operating input voltage is well above the UV Shutdown voltage AT ALL TIMES.

Start-Up Delay

Assuming that the output current is set at the rated maximum, the Vin to Vout Start-Up Time (see Specifications) is the time interval between the point when the rising input voltage crosses the Start-Up Threshold and the fully loaded regulated output voltage enters and remains within its specified regulation band. Actual measured times will vary with input source impedance, external input capacitance, input voltage slew rate and final value of the input voltage as it appears at the converter.

These converters include a soft start circuit to moderate the duty cycle of the PWM controller at power up, thereby limiting the input inrush current.

The On/Off Remote Control interval from inception to Vout regulated assumes that the converter already has its input voltage stabilized above the

Start-Up Threshold before the On command. The interval is measured from the On command until the output enters and remains within its specified regulation band. The specification assumes that the output is fully loaded at maximum rated current.

Input Source Impedance

These converters will operate to specifications without external components, assuming that the source voltage has very low impedance and reasonable input voltage regulation. Since real-world voltage sources have finite impedance, performance is improved by adding external filter components. Sometimes only a small ceramic capacitor is sufficient. Since it is difficult to totally characterize all applications, some experimentation may be needed. Note that external input capacitors must accept high speed switching currents.

Because of the switching nature of DC-DC converters, the input of these converters must be driven from a source with both low AC impedance and adequate DC input regulation. Performance will degrade with increasing input inductance. Excessive input inductance may inhibit operation. The DC input regulation specifies that the input voltage, once operating, must never degrade below the Shut-Down Threshold under all load conditions. Be sure to use adequate trace sizes and mount components close to the converter.

I/O Filtering, Input Ripple Current and Output Noise

All models in this converter series are tested and specified for input reflected ripple current and output noise using designated external input/output components, circuits and layout as shown in the figures below. External input capacitors (Cin in the figure) serve primarily as energy storage elements, minimizing line voltage variations caused by transient IR drops in the input conductors. Users should select input capacitors for bulk capacitance (at appropriate frequencies), low ESR and high RMS ripple current ratings. In the figure below, the Cbus and Lbus components simulate a typical DC voltage bus. Your specific system configuration may require additional considerations. Please note that the values of Cin, Lbus and Cbus will vary according to the specific converter model.

In critical applications, output ripple and noise (also referred to as periodic and random deviations or PARD) may be reduced by adding filter elements such as multiple external capacitors. Be sure to calculate component temperature rise from reflected AC current dissipated inside capacitor ESR.

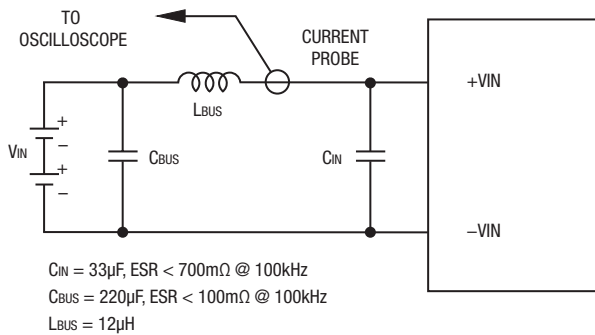

Figure 6. Measuring Input Ripple Current

Isolated, High-Density, Eighth-Brick DOSA Low Profile DC-DC Converters

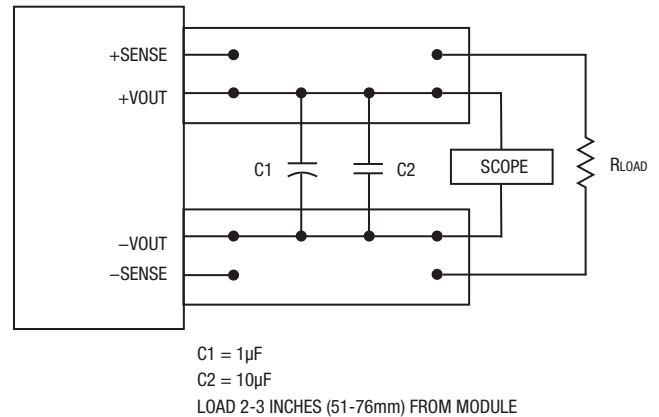

Figure 7. Measuring Output Ripple and Noise (PARD)

Floating Outputs

Since these are isolated DC-DC converters, their outputs are “floating” with respect to their input. The essential feature of such isolation is ideal ZERO CURRENT FLOW between input and output. Real-world converters however do exhibit tiny leakage currents between input and output (see Specifications). These leakages consist of both an AC stray capacitance coupling component and a DC leakage resistance. When using the isolation feature, do not allow the isolation voltage to exceed specifications. Otherwise the converter may be damaged. Designers will normally use the negative output (-Output) as the ground return of the load circuit. You can however use the positive output (+Output) as the ground return to effectively reverse the output polarity.

Minimum Output Loading Requirements

All models regulate within specification and are stable under no load to full load conditions. Operation under no load might however slightly increase output ripple and noise.

Thermal Shutdown

To protect against thermal overstress, these converters include thermal shutdown circuitry. If environmental conditions cause the temperature of the DC-DC's to rise above the Operating Temperature Range up to the shutdown temperature, an on-board electronic temperature sensor will power down the unit. When the temperature decreases below the turn-on threshold, the converter will automatically restart. There is a small amount of hysteresis to prevent rapid on/off cycling. The temperature sensor is typically located adjacent to the switching controller, approximately in the center of the unit. See the Performance and Functional Specifications.

CAUTION: If you operate too close to the thermal limits, the converter may shut down suddenly without warning. Be sure to thoroughly test your application to avoid unplanned thermal shutdown.

Temperature Derating Curves

The graphs in this data sheet illustrate typical operation under a variety of conditions. The Derating curves show the maximum continuous ambient air temperature and decreasing maximum output current which is acceptable under increasing forced airflow measured in Linear Feet per Minute (“LFM”). Note that these are AVERAGE measurements. The converter will accept brief increases in current or reduced airflow as long as the average is not exceeded.

**Isolated, High-Density, Eighth-Brick
DOSAs Low Profile DC-DC Converters**

Note that the temperatures are of the ambient airflow, not the converter itself which is obviously running at higher temperature than the outside air. Also note that very low flow rates (below about 25 LFM) are similar to “natural convection,” that is, not using fan-forced airflow.

Murata Power Solutions makes Characterization measurements in a closed cycle wind tunnel with calibrated airflow. We use both thermocouples and an infrared camera system to observe thermal performance. As a practical matter, it is quite difficult to insert an anemometer to precisely measure airflow in most applications. Sometimes it is possible to estimate the effective airflow if you thoroughly understand the enclosure geometry, entry/exit orifice areas and the fan flowrate specifications.

CAUTION: If you exceed these Derating guidelines, the converter may have an unplanned Over Temperature shut down. Also, these graphs are all collected near Sea Level altitude. Be sure to reduce the derating for higher altitude.

Output Overvoltage Protection (OVP)

This converter monitors its output voltage for an over-voltage condition. If the output exceeds OVP limits, the sensing circuit will power down the unit, and the output voltage will decrease. After a time-out period, the PWM will automatically attempt to restart, causing the output voltage to ramp up to its rated value. It is not necessary to power down and reset the converter for the automatic OVP-recovery restart.

If the fault condition persists and the output voltage climbs to excessive levels, the OVP circuitry will initiate another shutdown cycle. This on/off cycling is referred to as “hiccup” mode.

Output Fusing

The converter is extensively protected against current, voltage and temperature extremes. However your application circuit may need additional protection. In the extremely unlikely event of output circuit failure, excessive voltage could be applied to your circuit. Consider using appropriate external protection.

Output Current Limiting

As soon as the output current increases to approximately 125% to 150% of its maximum rated value, the DC-DC converter will enter a current-limiting mode. The output voltage will decrease proportionally with increases in output current, thereby maintaining a somewhat constant power output. This is also commonly referred to as power limiting.

Current limiting inception is defined as the point at which full power falls below the rated tolerance. See the Performance/Functional Specifications. Note particularly that the output current may briefly rise above its rated value in normal operation as long as the average output power is not exceeded. This enhances reliability and continued operation of your application. If the output current is too high, the converter will enter the short circuit condition.

Output Short Circuit Condition

When a converter is in current-limit mode, the output voltage will drop as the output current demand increases. If the output voltage drops too low (approximately 98% of nominal output voltage for most models), the magnetically coupled voltage used to develop the PWM bias voltage will also drop, thereby shutting down the PWM controller. Following a time-out period, the PWM will restart, causing the output voltage to begin rising to its appropriate value. If the short-circuit condition persists, another shutdown cycle will initiate. This

rapid on/off cycling is called “hiccup mode.” The hiccup cycling reduces the average output current, thereby preventing excessive internal temperatures and/or component damage.

The “hiccup” system differs from older latching short circuit systems because you do not have to power down the converter to make it restart. The system will automatically restore operation as soon as the short circuit condition is removed.

Remote Sense Input (Model UEE-3.3/30-D48 only)

Use the Sense inputs with caution. Sense is normally connected **at the load**. Sense inputs compensate for output voltage inaccuracy delivered at the load. This is done by correcting IR voltage drops along the output wiring and the current carrying capacity of PC board etc. This output drop (the difference between Sense and Vout when measured at the converter) should not exceed 0.5V. Consider using heavier wire if this drop is excessive. Sense inputs also improve the stability of the converter and load system by optimizing the control loop phase margin.

Note: The Sense input and power Vout lines are internally connected through low value resistors to their respective polarities so that the converter can operate without external connection to the Sense. Nevertheless, if the Sense function is not used for remote regulation, the user should connect +Sense to +Vout and –Sense to –Vout at the converter pins.

The remote Sense lines carry very little current. They are also capacitively coupled to the output lines and therefore are in the feedback control loop to regulate and stabilize the output. As such, they are not low impedance inputs and must be treated with care in PC board layouts. Sense lines on the PCB should run adjacent to DC signals, preferably Ground. In cables and discrete wiring, use twisted pair, shielded tubing or similar techniques.

Any long, distributed wiring and/or significant inductance introduced into the Sense control loop can adversely affect overall system stability. If in doubt, test your applications by observing the converter’s output transient response during step loads. There should not be any appreciable ringing or oscillation. You may also adjust the output trim slightly to compensate for voltage loss in any external filter elements. Do not exceed maximum power ratings.

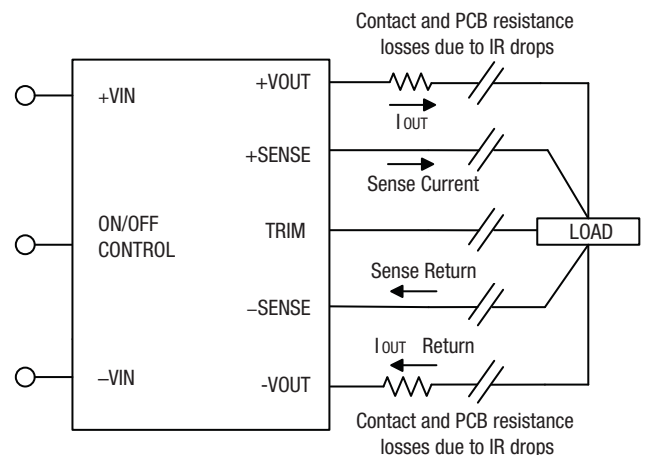

Figure 8. Remote Sense Circuit Configuration

Isolated, High-Density, Eighth-Brick
DOSA Low Profile DC-DC Converters

Please observe Sense inputs tolerance to avoid improper operation:

$$[V_{out(+)} - V_{out(-)}] - [Sense(+)-Sense(-)] \leq 10\% \text{ of } V_{out}$$

Output overvoltage protection is monitored at the output voltage pin, not the Sense pin. Therefore excessive voltage differences between Vout and Sense together with trim adjustment of the output can cause the overvoltage protection circuit to activate and shut down the output.

Power derating of the converter is based on the combination of maximum output current and the highest output voltage. Therefore the designer must insure:

$$(V_{out \text{ at pins}}) \times (I_{out}) \leq (\text{Max. rated output power})$$

Trimming the Output Voltage

The Trim input to the converter allows the user to adjust the output voltage over the rated trim range (please refer to the Specifications). In the trim equations and circuit diagrams that follow, trim adjustments use either a trimpot or a single fixed resistor connected between the Trim input and either the +Sense

or -Sense terminals. Trimming resistors should have a low temperature coefficient (± 100 ppm/deg.C or less) and be mounted close to the converter. Keep leads short. If the trim function is not used, leave the trim unconnected. With no trim, the converter will exhibit its specified output voltage accuracy.

There are two CAUTIONs to observe for the Trim input:

CAUTION: To avoid unplanned power down cycles, do not exceed EITHER the maximum output voltage OR the maximum output power when setting the trim. Be particularly careful with a trimpot. If the output voltage is excessive, the OVP circuit may inadvertently shut down the converter. If the maximum power is exceeded, the converter may enter current limiting. If the power is exceeded for an extended period, the converter may overheat and encounter overtemperature shut down.

CAUTION: Be careful of external electrical noise. The Trim input is a sensitive input to the converter's feedback control loop. Excessive electrical noise may cause instability or oscillation. Keep external connections short to the Trim input. Use shielding if needed.

Trim Equations

Trim Down

Connect trim resistor between trim pin and -Sense

$$R_{TrimDn} \text{ (k } \Omega) = \frac{5.11}{\Delta} - 10.22$$

Trim Up

Connect trim resistor between trim pin and +Sense

$$R_{TrimUp} \text{ (k } \Omega) = \frac{5.11 \times V_{NOM} \times (1+\Delta)}{1.225 \times \Delta} - \frac{5.11}{\Delta} - 10.22$$

Where,

$$\Delta = | (V_{NOM} - V_{OUT}) / V_{NOM} |$$

V_{NOM} is the nominal, untrimmed output voltage.

V_{OUT} is the desired new output voltage.

Do not exceed the specified trim range or maximum power ratings when adjusting trim. Use 1% precision resistors mounted close to the converter on short leads.

If sense is not installed, connect the trim resistor to the respective Vout pin.

Trim Circuits

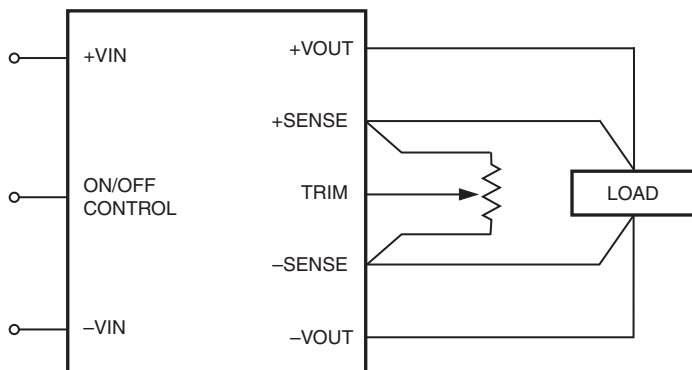

Figure 9. Trim Connections Using A Trimpot

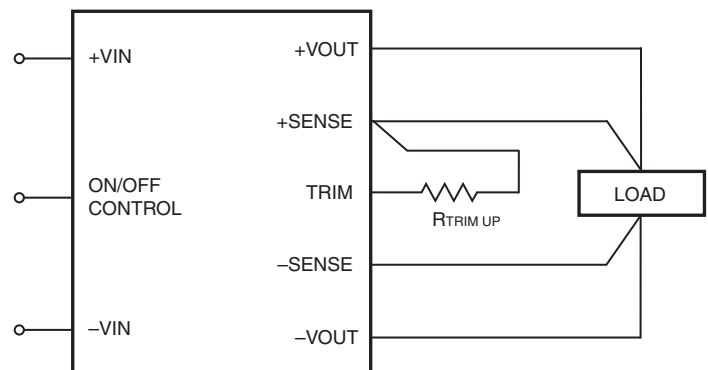

Figure 10. Trim Connections To Increase Output Voltages

Connect sense to its respective Vout pin if sense is not used with a remote load.

Isolated, High-Density, Eighth-Brick
DOSA Low Profile DC-DC Converters

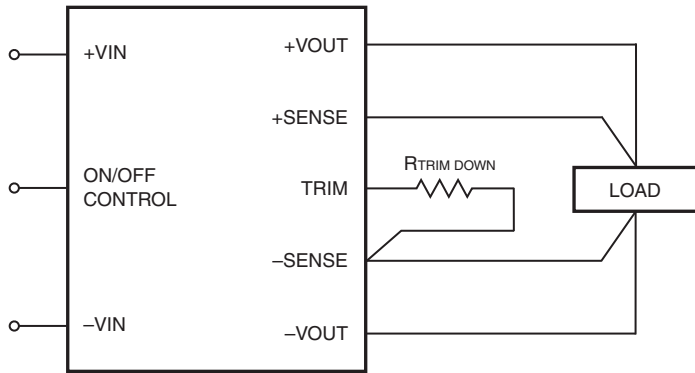

Figure 11. Trim Connections To Decrease Output Voltages

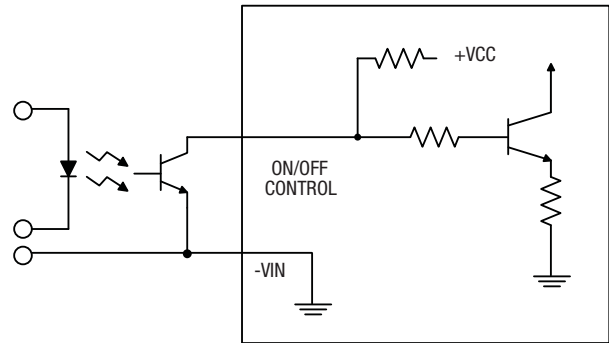

Figure 12. Driving the On/Off Control Pin (suggested circuit)

Remote On/Off Control

On the input side, a remote On/Off Control can be specified with either positive or negative logic logic.

Positive: Models equipped with positive logic are enabled when the On/Off pin is left open or is pulled high to +Vin with respect to -Vin. An internal bias current causes the open pin to rise to approximately +13.5V. Some models will also turn on at lower intermediate voltages (see Specifications). Positive-logic devices are disabled when the On/Off is grounded or brought to within a low voltage (see Specifications) with respect to -Vin.

Negative: Models with negative logic are on (enabled) when the On/Off is grounded or brought to within a low voltage (see Specifications) with respect to -Vin. The device is off (disabled) when the On/Off is left open or is pulled high to approximately +13.5V with respect to -Vin.

Dynamic control of the On/Off function should be able to sink the specified signal current when brought low and withstand appropriate voltage when brought high. Be aware too that there is a finite time in milliseconds (see Specifications) between the time of On/Off Control activation and stable, regulated output. This time will vary slightly with output load type and current and input conditions.

Output Capacitive Load

These converters do not require external capacitance added to achieve rated specifications. Users should only consider adding capacitance to reduce switching noise and/or to handle spike current step loads. Install only enough capacitance to achieve noise objectives. Excess external capacitance may cause regulation problems, slower transient response and possible instability. Proper wiring of the Sense inputs will improve these factors under capacitive load.

The maximum rated output capacitance and ESR specification is given for a capacitor installed immediately adjacent to the converter. Any extended output wiring or smaller wire gauge or less ground plane may tolerate somewhat higher capacitance. Also, capacitors with higher ESR may use a larger capacitance.

Isolated, High-Density, Eighth-Brick
DOSA Low Profile DC-DC Converters

Vertical Wind Tunnel

Murata Power Solutions employs a computer controlled custom-designed closed loop vertical wind tunnel, infrared video camera system, and test instrumentation for accurate airflow and heat dissipation analysis of power products. The system includes a precision low flow-rate anemometer, variable speed fan, power supply input and load controls, temperature gauges, and adjustable heating element.

The IR camera monitors the thermal performance of the Unit Under Test (UUT) under static steady-state conditions. A special optical port is used which is transparent to infrared wavelengths.

Both through-hole and surface mount converters are soldered down to a 10" x 10" host carrier board for realistic heat absorption and spreading. Both longitudinal and transverse airflow studies are possible by rotation of this carrier board since there are often significant differences in the heat dissipation in the two airflow directions. The combination of adjustable airflow, adjustable ambient heat, and adjustable Input/Output currents and voltages mean that a very wide range of measurement conditions can be studied.

The collimator reduces the amount of turbulence adjacent to the UUT by minimizing airflow turbulence. Such turbulence influences the effective heat transfer characteristics and gives false readings. Excess turbulence removes more heat from some surfaces and less heat from others, possibly causing uneven overheating.

Both sides of the UUT are studied since there are different thermal gradients on each side. The adjustable heating element and fan, built-in temperature gauges, and no-contact IR camera mean that power supplies are tested in real-world conditions.

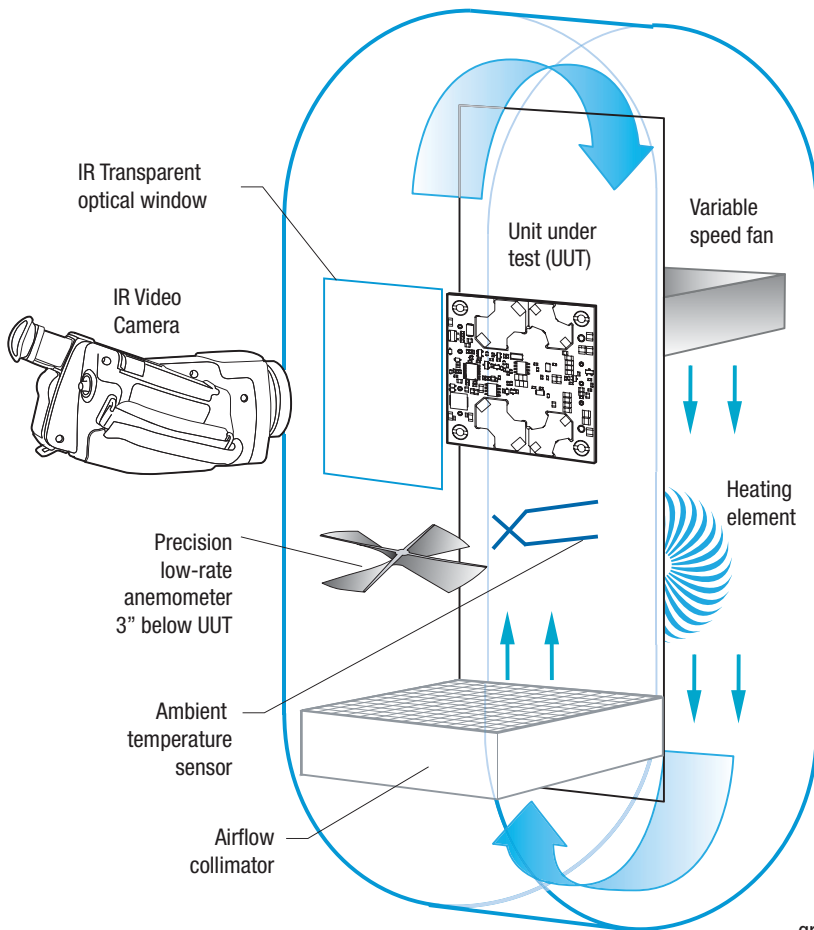

Figure 13. Vertical Wind Tunnel





Компания «ЭлектроПласт» предлагает заключение долгосрочных отношений при поставках импортных электронных компонентов на взаимовыгодных условиях!

Наши преимущества:

- Оперативные поставки широкого спектра электронных компонентов отечественного и импортного производства напрямую от производителей и с крупнейших мировых складов;
- Поставка более 17-ти миллионов наименований электронных компонентов;
- Поставка сложных, дефицитных, либо снятых с производства позиций;
- Оперативные сроки поставки под заказ (от 5 рабочих дней);
- Экспресс доставка в любую точку России;
- Техническая поддержка проекта, помощь в подборе аналогов, поставка прототипов;
- Система менеджмента качества сертифицирована по Международному стандарту ISO 9001;
- Лицензия ФСБ на осуществление работ с использованием сведений, составляющих государственную тайну;
- Поставка специализированных компонентов (Xilinx, Altera, Analog Devices, Intersil, Interpoint, Microsemi, Aeroflex, Peregrine, Syfer, Eurofarad, Texas Instrument, Miteq, Cobham, E2V, MA-COM, Hittite, Mini-Circuits, General Dynamics и др.);

Помимо этого, одним из направлений компании «ЭлектроПласт» является направление «Источники питания». Мы предлагаем Вам помощь Конструкторского отдела:

- Подбор оптимального решения, техническое обоснование при выборе компонента;
- Подбор аналогов;
- Консультации по применению компонента;
- Поставка образцов и прототипов;
- Техническая поддержка проекта;
- Защита от снятия компонента с производства.



Как с нами связаться

Телефон: 8 (812) 309 58 32 (многоканальный)

Факс: 8 (812) 320-02-42

Электронная почта: org@eplast1.ru

Адрес: 198099, г. Санкт-Петербург, ул. Калинина, дом 2, корпус 4, литера А.