

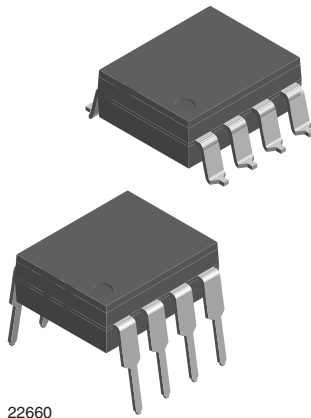

Widebody, High Isolation, High Speed Optocoupler, 1 MBd

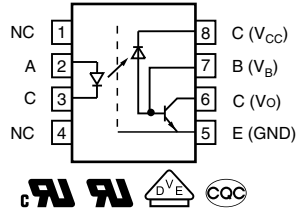

22660



FEATURES

- External creepage > 10 mm
- Reinforced isolation
- Internal shield for very high input to output noise isolation
- High common mode interference immunity
- Material categorization: for definitions of compliance please see www.vishay.com/doc?99912



APPLICATIONS

- Solar inverters
- Industrial motor drives
- Welding equipment
- Isolated industrial communications
- Noise isolation of sensitive circuits

AGENCY APPROVALS

The safety application model number covering all products in this datasheet is VOW135 or VOW136 respectively. This model number should be used when consulting safety agency documents.

- UL1577
- cUL
- DIN EN 60747-5-5 (VDE 0884-5)
- CQC

| ORDERING INFORMATION | | |
|---|--------------|--------------|
| <div style="display: flex; justify-content: space-around; align-items: center;"> <div style="border: 1px solid black; padding: 2px 5px; margin: 2px;">V</div> <div style="border: 1px solid black; padding: 2px 5px; margin: 2px;">O</div> <div style="border: 1px solid black; padding: 2px 5px; margin: 2px;">W</div> <div style="border: 1px solid black; padding: 2px 5px; margin: 2px;">1</div> <div style="border: 1px solid black; padding: 2px 5px; margin: 2px;">3</div> <div style="border: 1px solid black; padding: 2px 5px; margin: 2px;">#</div> <div style="border: 1px solid black; padding: 2px 5px; margin: 2px;">-</div> <div style="border: 1px solid black; padding: 2px 5px; margin: 2px;">X</div> <div style="border: 1px solid black; padding: 2px 5px; margin: 2px;">0</div> <div style="border: 1px solid black; padding: 2px 5px; margin: 2px;">#</div> <div style="border: 1px solid black; padding: 2px 5px; margin: 2px;">#</div> <div style="border: 1px solid black; padding: 2px 5px; margin: 2px;">T</div> </div> <p style="text-align: center; margin-top: 5px;"> PART NUMBER PACKAGE OPTION TAPE AND REEL </p> | | |
| AGENCY CERTIFIED/PACKAGE | CTR (%) | |
| VDE, UL, cUL, CQC | ≥ 7 | ≥ 19 |
| DIP-8, 400 mil, widebody | VOW135-X001 | VOW136-X001 |
| SMD-8, 400 mil, option 7, widebody | VOW135-X017T | VOW136-X017T |



| ABSOLUTE MAXIMUM RATINGS ($T_{amb} = 25\text{ }^{\circ}\text{C}$, unless otherwise specified) | | | | |
|---|--|---------------------|-------------|-----------------------------|
| PARAMETER | TEST CONDITION | SYMBOL | VALUE | UNIT |
| INPUT | | | | |
| Reverse voltage | | V_R | 3 | V |
| Forward current | | I_F | 25 | mA |
| Peak forward current | $t = 1\text{ ms}$, duty cycle 50 % | I_{FM} | 50 | mA |
| Maximum surge forward current | $t \leq 1\text{ }\mu\text{s}$, 300 pulses/s | I_{FSM} | 1 | A |
| Thermal resistance | | R_{thja} | 700 | $^{\circ}\text{C}/\text{W}$ |
| Power dissipation | | P_{diss} | 45 | mW |
| Input junction temperature | | $T_{j\text{ max.}}$ | 125 | $^{\circ}\text{C}$ |
| OUTPUT | | | | |
| Supply voltage | | V_S | -0.5 to 30 | V |
| Output voltage | | V_O | -0.5 to 25 | V |
| Emitter base voltage | | V_{EBO} | 5 | V |
| Average output current | | I_O | 8 | mA |
| Peak output current | | I_O | 16 | mA |
| Base current | | I_B | 5 | mA |
| Thermal resistance | | R_{thja} | 300 | $^{\circ}\text{C}/\text{W}$ |
| Power dissipation | | P_{diss} | 100 | mW |
| Output junction temperature | | $T_{j\text{ max.}}$ | 125 | $^{\circ}\text{C}$ |
| COUPLER | | | | |
| Isolation voltage | $t = 1\text{ min}$ | V_{ISO} | 5300 | V_{RMS} |
| Storage temperature range | | T_{stg} | -55 to +150 | $^{\circ}\text{C}$ |
| Ambient temperature range | | T_{amb} | -40 to +100 | $^{\circ}\text{C}$ |
| Soldering temperature ⁽¹⁾ | max. $\leq 10\text{ s}$, dip soldering $\geq 0.5\text{ mm}$ distance from case bottom | T_{sld} | 260 | $^{\circ}\text{C}$ |

Notes

- Stresses in excess of the absolute maximum ratings can cause permanent damage to the device. Functional operation of the device is not implied at these or any other conditions in excess of those given in the operational sections of this document. Exposure to absolute maximum ratings for extended periods of the time can adversely affect reliability.
- ⁽¹⁾ Refer to wave profile for soldering conditions for through hole devices.

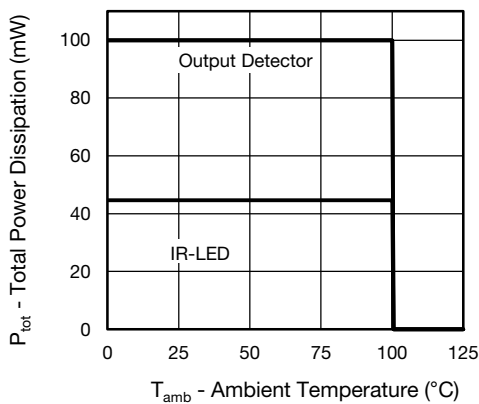

Fig. 1 - Maximum Power vs. Operating Temperature

| ELECTRICAL CHARACTERISTICS ($T_{amb} = 0\text{ }^{\circ}\text{C}$ to $70\text{ }^{\circ}\text{C}$, unless otherwise specified) | | | | | | | |
|---|--|--------|-------------------------------|------|------|------|------------------------|
| PARAMETER | TEST CONDITION | PART | SYMBOL | MIN. | TYP. | MAX. | UNIT |
| INPUT | | | | | | | |
| Forward voltage | $I_F = 16\text{ mA}$ | | V_F | | 1.38 | 1.9 | V |
| Breakdown voltage | $I_R = 10\text{ }\mu\text{A}$ | | V_{BR} | 3 | | | V |
| Reverse current | $V_R = 3\text{ V}$ | | I_R | | 0.5 | 10 | μA |
| Input capacitance | $V_R = 0\text{ V}$, $f = 1\text{ MHz}$ | | C_I | | 36 | | pF |
| Temperature coefficient of forward voltage | $I_F = 16\text{ mA}$ | | $\Delta V_F / \Delta T_{amb}$ | | -1.9 | | mV/ $^{\circ}\text{C}$ |
| OUTPUT | | | | | | | |
| Logic low supply current | $I_F = 16\text{ mA}$, $V_O = \text{open}$, $V_{CC} = 15\text{ V}$ | | I_{CCL} | | 50 | 200 | μA |
| Logic high supply current | $I_F = 0\text{ A}$, $V_O = \text{open}$, $V_{CC} = 15\text{ V}$ | | I_{CCH} | | 0.02 | 2 | μA |
| Output voltage, output logic low | $I_F = 16\text{ mA}$, $V_{CC} = 4.5\text{ V}$, $I_O = 0.8\text{ mA}$ | VOW135 | V_{OL} | | 0.1 | 0.5 | V |
| | $I_F = 16\text{ mA}$, $V_{CC} = 4.5\text{ V}$, $I_O = 2.4\text{ mA}$ | VOW136 | V_{OL} | | 0.1 | 0.5 | V |
| Output current, output logic high | $I_F = 0\text{ mA}$, $V_O = V_{CC} = 5.5\text{ V}$ | | I_{OH} | | 3 | 500 | nA |
| | $I_F = 0\text{ mA}$, $V_O = V_{CC} = 15\text{ V}$ | | I_{OH} | | 0.01 | 1 | μA |
| Output capacitance | $V_R = 0\text{ V}$, $f = 1\text{ MHz}$ | | C_O | | 3.70 | | pF |
| COUPLER | | | | | | | |
| Capacitance (input to output) | $f = 1\text{ MHz}$ | | C_{IO} | | 0.9 | | pF |

Note

- Minimum and maximum values are testing requirements. Typical values are characteristics of the device and are the result of engineering evaluation. Typical values are for information only and are not part of the testing requirements.

| CURRENT TRANSFER RATIO ($T_{amb} = 0\text{ }^{\circ}\text{C}$ to $70\text{ }^{\circ}\text{C}$, unless otherwise specified) | | | | | | | |
|---|---|--------|--------|------|------|------|------|
| PARAMETER | TEST CONDITION | PART | SYMBOL | MIN. | TYP. | MAX. | UNIT |
| Current transfer ratio | $I_F = 16\text{ mA}$, $V_O = 0.4\text{ V}$, $V_{CC} = 4.5\text{ V}$, $T_{amb} = 25\text{ }^{\circ}\text{C}$ | VOW135 | CTR | 7 | 18 | | % |
| | | VOW136 | CTR | 19 | 24 | | % |
| | $I_F = 16\text{ mA}$, $V_O = 0.5\text{ V}$, $V_{CC} = 4.5\text{ V}$ | VOW135 | CTR | 5 | | | % |
| | | VOW136 | CTR | 15 | | | % |

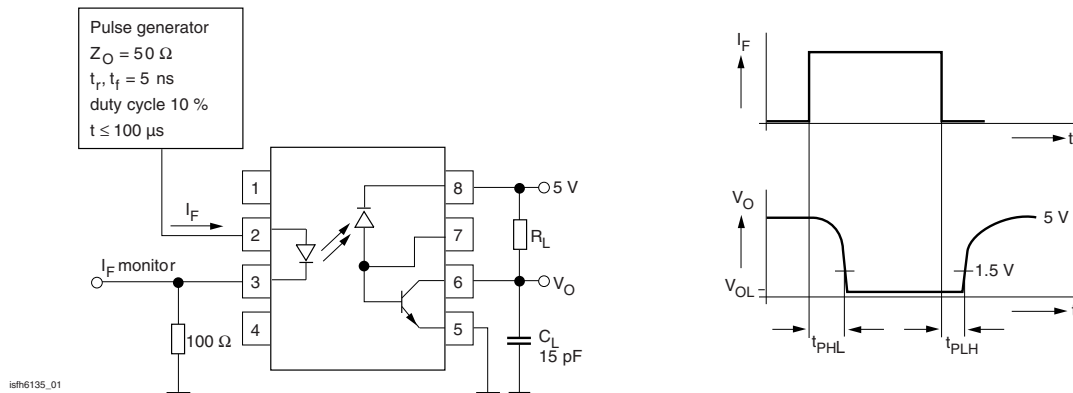

Fig. 2 - Schematics

| SWITCHING CHARACTERISTICS ($T_{amb} = 0\text{ }^{\circ}\text{C}$ to $70\text{ }^{\circ}\text{C}$, unless otherwise specified) | | | | | | | |
|--|---|--------|-----------|------|------|------|---------------|
| PARAMETER | TEST CONDITION | PART | SYMBOL | MIN. | TYP. | MAX. | UNIT |
| High to low | $I_F = 16\text{ mA}$, $V_{CC} = 5\text{ V}$, $R_L = 4.1\text{ k}\Omega$ | VOW135 | t_{PHL} | | 0.2 | 2.0 | μs |
| | $I_F = 16\text{ mA}$, $V_{CC} = 5\text{ V}$, $R_L = 1.9\text{ k}\Omega$ | VOW136 | t_{PHL} | | 0.2 | 1.0 | μs |
| Low to high | $I_F = 16\text{ mA}$, $V_{CC} = 5\text{ V}$, $R_L = 4.1\text{ k}\Omega$ | VOW135 | t_{PLH} | | 1.3 | 2.0 | μs |
| | $I_F = 16\text{ mA}$, $V_{CC} = 5\text{ V}$, $R_L = 1.9\text{ k}\Omega$ | VOW136 | t_{PLH} | | 0.6 | 1.0 | μs |

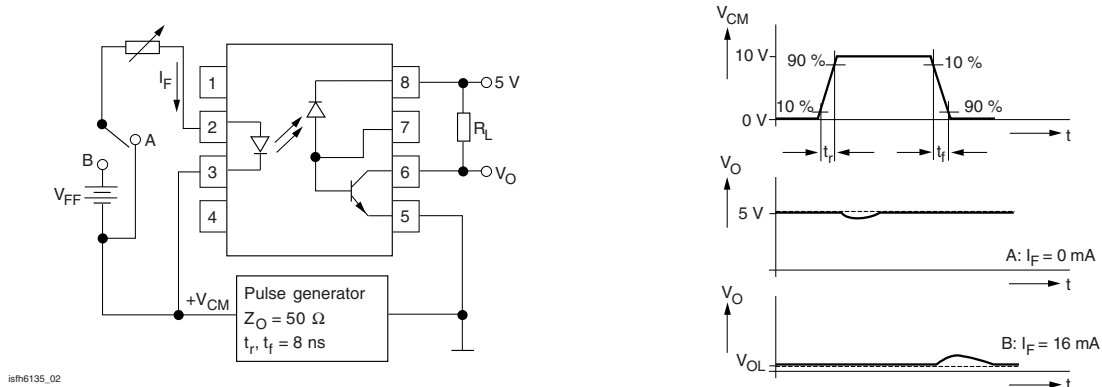

Fig. 3 - Common Mode Interference Immunity

| COMMON MODE TRANSIENT IMMUNITY ($T_{amb} = 0\text{ }^{\circ}\text{C}$ to $70\text{ }^{\circ}\text{C}$, unless otherwise specified) | | | | | | | |
|---|---|--------|--------|------|------|------|------------------------|
| PARAMETER | TEST CONDITION | PART | SYMBOL | MIN. | TYP. | MAX. | UNIT |
| High | $V_{CM} = 10\text{ V}_{PP}$, $V_{CC} = 5\text{ V}$, $I_F = 0\text{ mA}$, $R_L = 4.1\text{ k}\Omega$ | VOW135 | CM_H | 1000 | | | $\text{V}/\mu\text{s}$ |
| | $V_{CM} = 10\text{ V}_{PP}$, $V_{CC} = 5\text{ V}$, $I_F = 0\text{ mA}$, $R_L = 1.9\text{ k}\Omega$ | VOW136 | CM_H | 1000 | | | $\text{V}/\mu\text{s}$ |
| Low | $V_{CM} = 10\text{ V}_{PP}$, $V_{CC} = 5\text{ V}$, $I_F = 16\text{ mA}$, $R_L = 4.1\text{ k}\Omega$ | VOW135 | CM_L | 1000 | | | $\text{V}/\mu\text{s}$ |
| | $V_{CM} = 10\text{ V}_{PP}$, $V_{CC} = 5\text{ V}$, $I_F = 16\text{ mA}$, $R_L = 1.9\text{ k}\Omega$ | VOW136 | CM_L | 1000 | | | $\text{V}/\mu\text{s}$ |

| SAFETY AND INSULATION RATINGS | | | | |
|--|--|------------|----------------|--------------------|
| PARAMETER | | SYMBOL | VALUE | UNIT |
| MAXIMUM SAFETY RATINGS | | | | |
| Output safety power | | P_{SO} | 700 | mW |
| Input safety current | | I_{si} | 400 | mA |
| Safety temperature | | T_S | 150 | $^{\circ}\text{C}$ |
| Comparative tracking index | | CTI | 250 | |
| INSULATION RATED PARAMETERS | | | | |
| Maximum withstanding isolation voltage | $t = 1\text{ min}$ | V_{ISO} | 5300 | V_{RMS} |
| Maximum transient isolation voltage | | V_{IOTM} | 8000 | V_{peak} |
| Maximum repetitive peak isolation voltage | | V_{IORM} | 1414 | V_{peak} |
| Insulation resistance | $T_{amb} = 25\text{ }^{\circ}\text{C}$, $V_{DC} = 500\text{ V}$ | R_{IO} | $\geq 10^{12}$ | Ω |
| | $T_{amb} = 100\text{ }^{\circ}\text{C}$, $V_{DC} = 500\text{ V}$ | R_{IO} | $\geq 10^{11}$ | Ω |
| Input to output test voltage, method b | $V_{IORM} \times 1.875 = V_{PR}$, 100 % production test with $t_M = 1\text{ s}$, partial discharge $< 5\text{ pC}$ | V_{PR} | 2651 | V_{peak} |
| Input to output test voltage, method a | $V_{IORM} \times 1.6 = V_{PR}$, 100 % production test with $t_M = 10\text{ s}$, partial discharge $< 5\text{ pC}$ | V_{PR} | 2262 | V_{peak} |
| Climatic classification (according to IEC 68 part 1) | | | 55/100/21 | |
| Environment (pollution degree in accordance to DIN VDE 0109) | | | 2 | |
| Clearance distance (DIP-8, wide-body) | | | ≥ 10 | mm |
| Creepage distance (DIP-8, wide-body) | | | ≥ 10 | mm |
| Insulation thickness | | | DTI | ≥ 0.4 mm |

Note

- As per DIN EN 60747-5-5, § 7.4.3.8.2, this optocoupler is suitable for “safe electrical insulation” only within the safety ratings. Compliance with the safety ratings shall be ensured by means of protective circuits.

TYPICAL CHARACTERISTICS ($T_{amb} = 25\text{ }^{\circ}\text{C}$, unless otherwise specified)

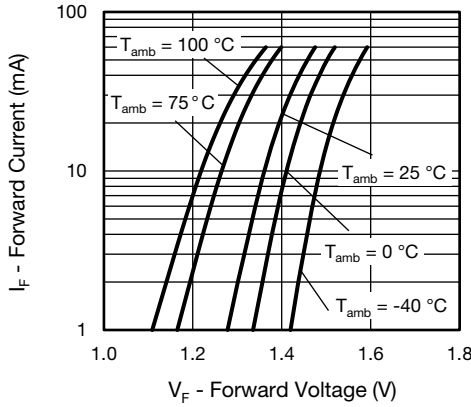

Fig. 4 - Output Current vs. Forward Voltage

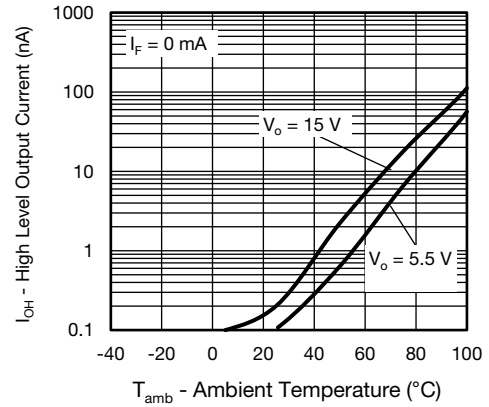

Fig. 7 - Logic High Level Output Current vs. Temperature

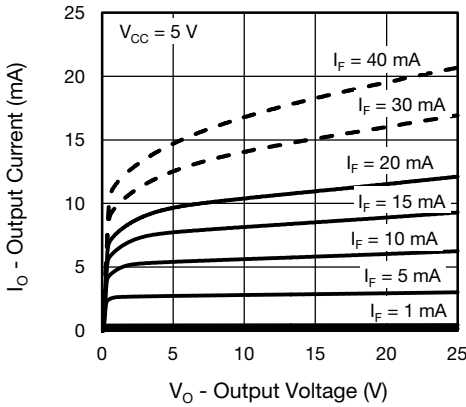

Fig. 5 - Output Current vs. Output Voltage

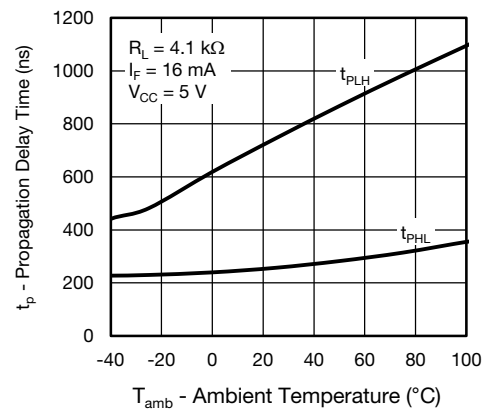

Fig. 8 - Propagation Delay vs. Ambient Temperature - VOW135

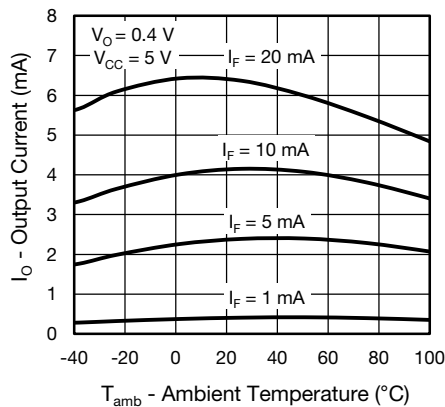

Fig. 6 - Output Current vs. Temperature

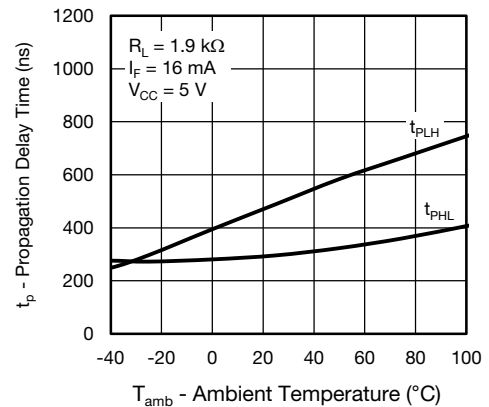

Fig. 9 - Propagation Delay vs. Ambient Temperature - VOW136

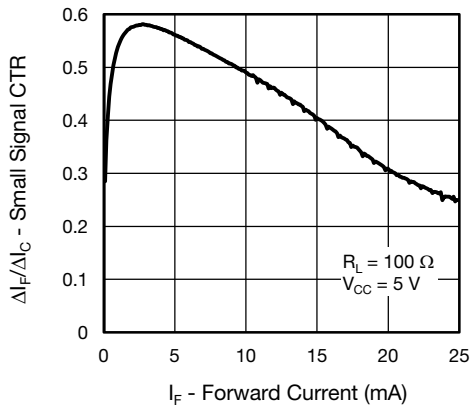

Fig. 10 - Small Signal Current Transfer Ratio vs. Forward Current

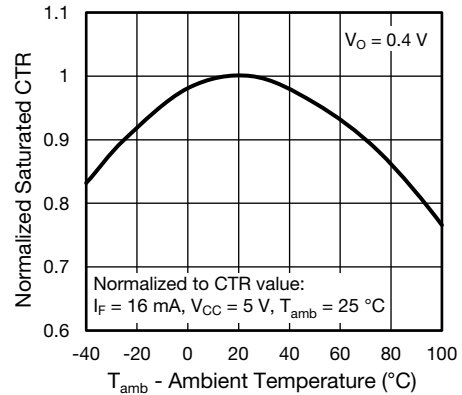

Fig. 13 - Normalized Saturated CTR vs. Ambient Temperature

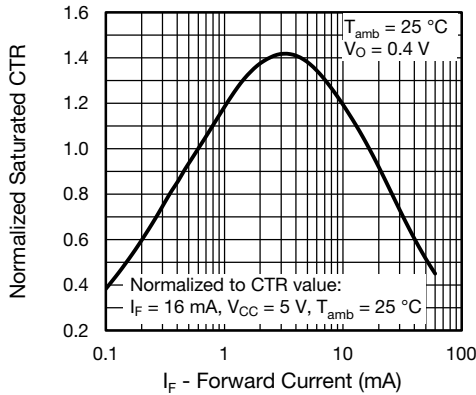

Fig. 11 - Normalized Saturated CTR vs. Forward Current

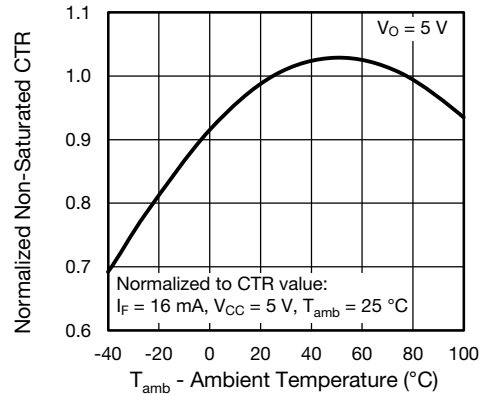

Fig. 14 - Normalized Non-Saturated CTR vs. Ambient Temperature

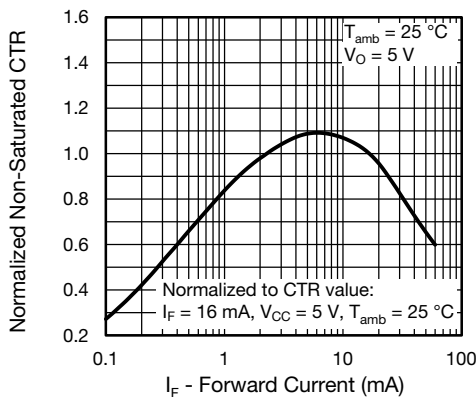

Fig. 12 - Normalized Non-Saturated CTR vs. Forward Current



PACKAGE DIMENSIONS in millimeters

DIP-8, widebody



SMD-8, widebody (Option 7)

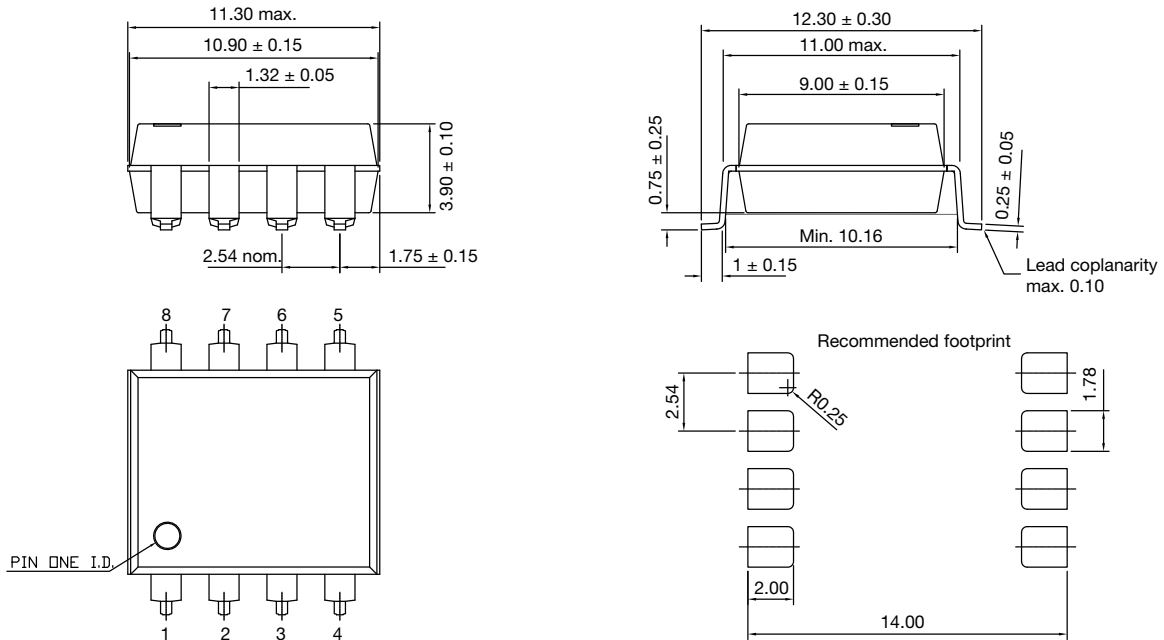

PACKAGE MARKING (Example of VOW136-X017T)

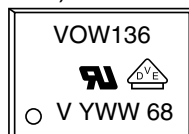

Note

- Tape and reel suffix (T) is not part of the package marking.

PACKING INFORMATION (TAPE AND REEL)

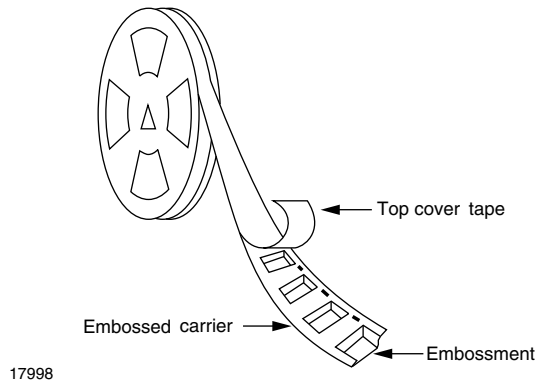

Fig. 15 - Tape and Reel Shipping Medium

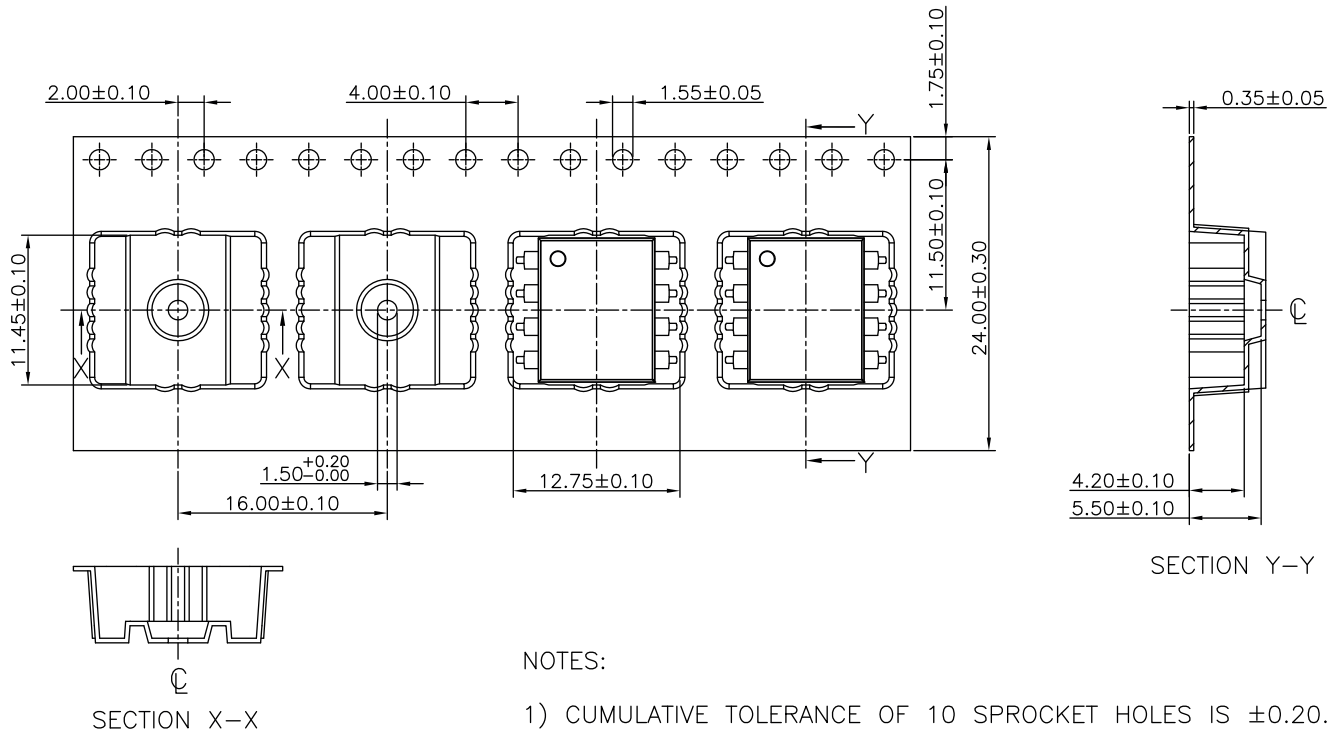
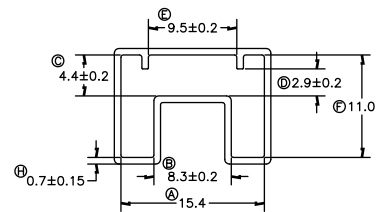
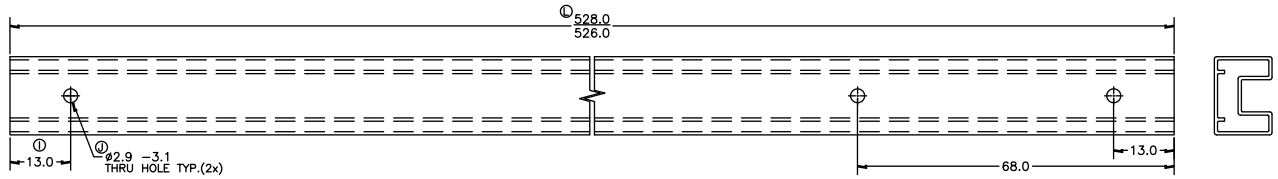

Fig. 16 - Tape and Reel Packing Option 7 (750 parts per reel)



PACKING INFORMATION (Tubes)

| DEVICE PER TUBE | | | |
|-----------------|------------|----------|-----------|
| TYPE | UNITS/TUBE | TUBE/BOX | UNITS/BOX |
| DIP-8, widebody | 40 | 30 | 1200 |



| | |
|---------------|-------|
| TUBE COLOUR: | CLEAR |
| PRINT COLOUR: | - |

1. ALL DIMENSIONS ARE IN MILLIMETERS, U.O.S.

1. ALL TUBE TOLERANCES TO BE ± 0.25 UNLESS OTHERWISE SPECIFIED.
2. ALL RADII AND ANGLES REFERENCE ONLY, UNLESS OTHERWISE SPECIFIED.



Disclaimer

ALL PRODUCT, PRODUCT SPECIFICATIONS AND DATA ARE SUBJECT TO CHANGE WITHOUT NOTICE TO IMPROVE RELIABILITY, FUNCTION OR DESIGN OR OTHERWISE.

Vishay Intertechnology, Inc., its affiliates, agents, and employees, and all persons acting on its or their behalf (collectively, "Vishay"), disclaim any and all liability for any errors, inaccuracies or incompleteness contained in any datasheet or in any other disclosure relating to any product.

Vishay makes no warranty, representation or guarantee regarding the suitability of the products for any particular purpose or the continuing production of any product. To the maximum extent permitted by applicable law, Vishay disclaims (i) any and all liability arising out of the application or use of any product, (ii) any and all liability, including without limitation special, consequential or incidental damages, and (iii) any and all implied warranties, including warranties of fitness for particular purpose, non-infringement and merchantability.

Statements regarding the suitability of products for certain types of applications are based on Vishay's knowledge of typical requirements that are often placed on Vishay products in generic applications. Such statements are not binding statements about the suitability of products for a particular application. It is the customer's responsibility to validate that a particular product with the properties described in the product specification is suitable for use in a particular application. Parameters provided in datasheets and/or specifications may vary in different applications and performance may vary over time. All operating parameters, including typical parameters, must be validated for each customer application by the customer's technical experts. Product specifications do not expand or otherwise modify Vishay's terms and conditions of purchase, including but not limited to the warranty expressed therein.

Except as expressly indicated in writing, Vishay products are not designed for use in medical, life-saving, or life-sustaining applications or for any other application in which the failure of the Vishay product could result in personal injury or death. Customers using or selling Vishay products not expressly indicated for use in such applications do so at their own risk. Please contact authorized Vishay personnel to obtain written terms and conditions regarding products designed for such applications.

No license, express or implied, by estoppel or otherwise, to any intellectual property rights is granted by this document or by any conduct of Vishay. Product names and markings noted herein may be trademarks of their respective owners.

Material Category Policy

Vishay Intertechnology, Inc. hereby certifies that all its products that are identified as RoHS-Compliant fulfill the definitions and restrictions defined under Directive 2011/65/EU of The European Parliament and of the Council of June 8, 2011 on the restriction of the use of certain hazardous substances in electrical and electronic equipment (EEE) - recast, unless otherwise specified as non-compliant.

Please note that some Vishay documentation may still make reference to RoHS Directive 2002/95/EC. We confirm that all the products identified as being compliant to Directive 2002/95/EC conform to Directive 2011/65/EU.

Vishay Intertechnology, Inc. hereby certifies that all its products that are identified as Halogen-Free follow Halogen-Free requirements as per JEDEC JS709A standards. Please note that some Vishay documentation may still make reference to the IEC 61249-2-21 definition. We confirm that all the products identified as being compliant to IEC 61249-2-21 conform to JEDEC JS709A standards.



Компания «ЭлектроПласт» предлагает заключение долгосрочных отношений при поставках импортных электронных компонентов на взаимовыгодных условиях!

Наши преимущества:

- Оперативные поставки широкого спектра электронных компонентов отечественного и импортного производства напрямую от производителей и с крупнейших мировых складов;
- Поставка более 17-ти миллионов наименований электронных компонентов;
- Поставка сложных, дефицитных, либо снятых с производства позиций;
- Оперативные сроки поставки под заказ (от 5 рабочих дней);
- Экспресс доставка в любую точку России;
- Техническая поддержка проекта, помощь в подборе аналогов, поставка прототипов;
- Система менеджмента качества сертифицирована по Международному стандарту ISO 9001;
- Лицензия ФСБ на осуществление работ с использованием сведений, составляющих государственную тайну;
- Поставка специализированных компонентов (Xilinx, Altera, Analog Devices, Intersil, Interpoint, Microsemi, Aeroflex, Peregrine, Syfer, Eurofarad, Texas Instrument, Miteq, Cobham, E2V, MA-COM, Hittite, Mini-Circuits, General Dynamics и др.);

Помимо этого, одним из направлений компании «ЭлектроПласт» является направление «Источники питания». Мы предлагаем Вам помощь Конструкторского отдела:

- Подбор оптимального решения, техническое обоснование при выборе компонента;
- Подбор аналогов;
- Консультации по применению компонента;
- Поставка образцов и прототипов;
- Техническая поддержка проекта;
- Защита от снятия компонента с производства.



Как с нами связаться

Телефон: 8 (812) 309 58 32 (многоканальный)

Факс: 8 (812) 320-02-42

Электронная почта: org@eplast1.ru

Адрес: 198099, г. Санкт-Петербург, ул. Калинина, дом 2, корпус 4, литера А.