

PRODUCT NUMBER
SEE TABLE

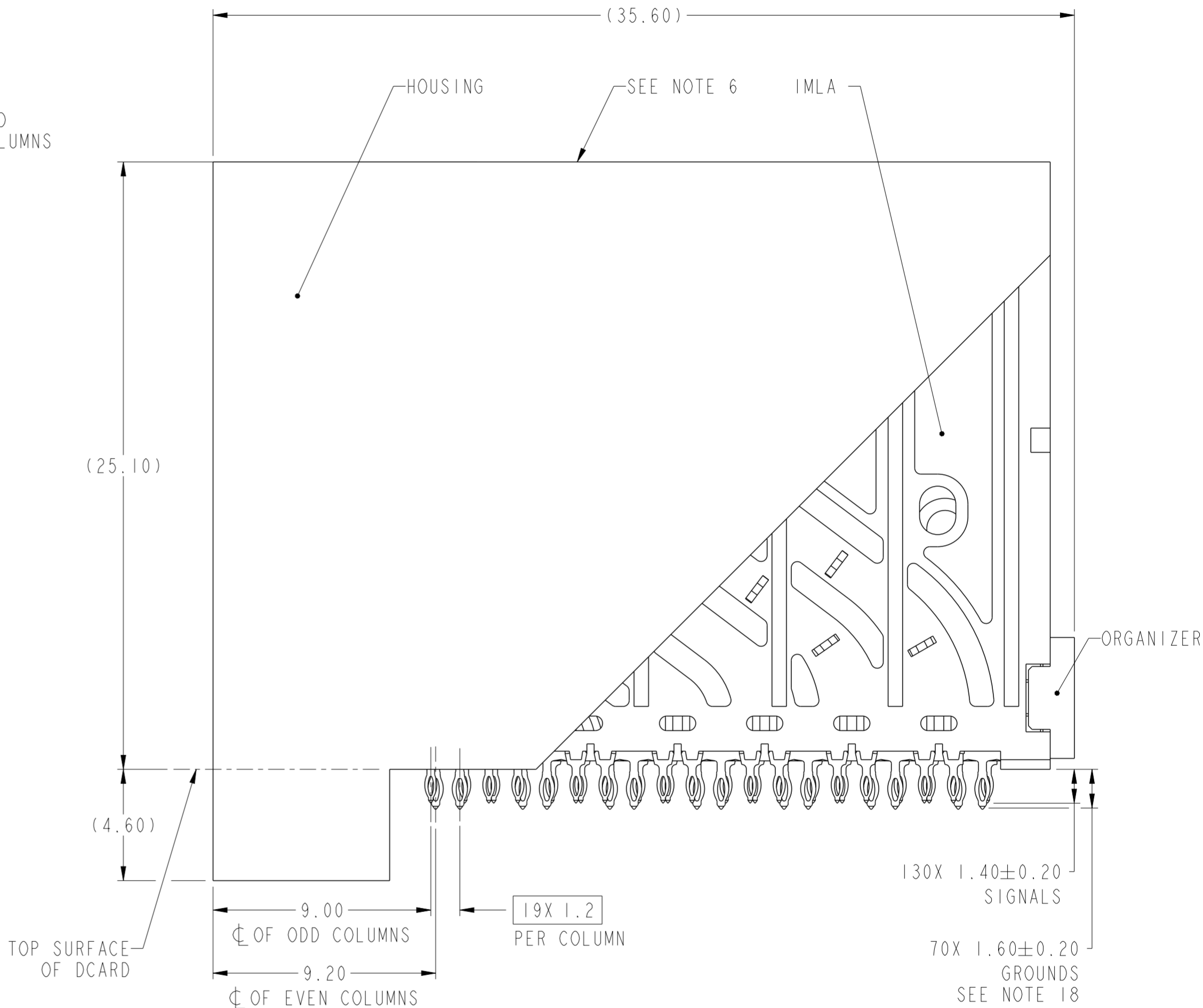
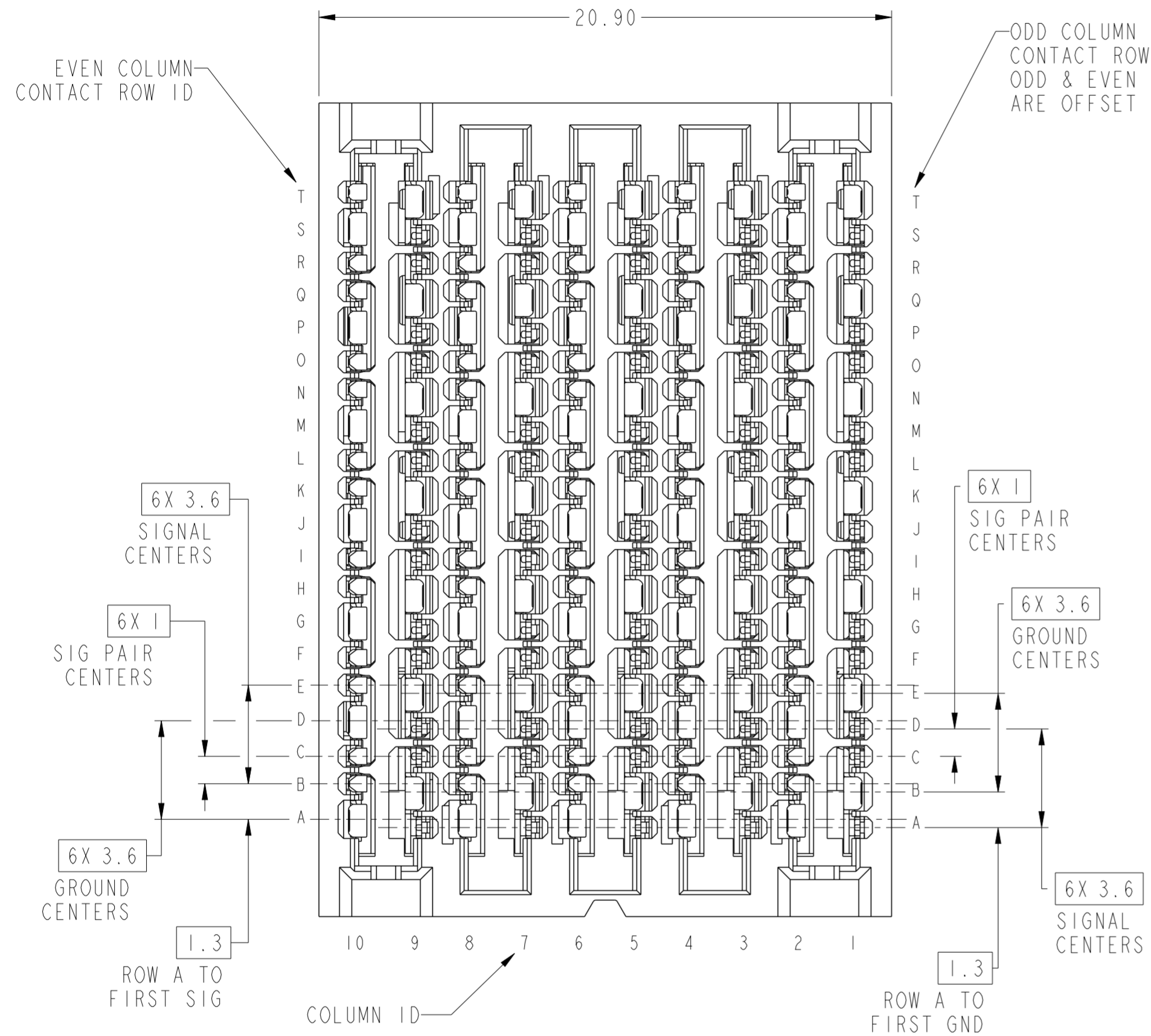

10131764-101LF
STANDARD MATE RECEPTACLE
SCALE 6:1

spec ref	SEE NOTES	dr	Will Liu	2014/12/16	projection	MM	size	A2	scale	6:1										
tolerance std	TOLERANCES UNLESS OTHERWISE SPECIFIED	eng	Norman Luo	2017/10/24			ecn no	ELX-DG-28235-1	rel level	Released										
ASME Y14.5M		chr	Justin Chen	2017/11/29																
		appr	Heaven Cen	2017/11/30																
surface	<table border="1"> <tr> <td>linear</td> <td>0.X</td> <td>±.3</td> </tr> <tr> <td></td> <td>0.XX</td> <td>±.10</td> </tr> <tr> <td></td> <td>0.XXX</td> <td>±.050</td> </tr> <tr> <td>angular</td> <td>0°</td> <td>±°</td> </tr> </table>	linear	0.X	±.3		0.XX	±.10		0.XXX	±.050	angular	0°	±°			Amphenol FCI title ExaMAX R.A. RECEPTACLE ASSY 6 PR, 10 IMLA, 200 POS, 21mm		product family ExaMAX	rel level Released	sheet 1 of 11
linear	0.X	±.3																		
	0.XX	±.10																		
	0.XXX	±.050																		
angular	0°	±°																		
cat. no.	SEE TABLE	Product - Customer Drw	title 10131764	rev B																

1 2 3 4 5 6 7 8

A

B

C

D

E

F

A

B

C

D

E

F

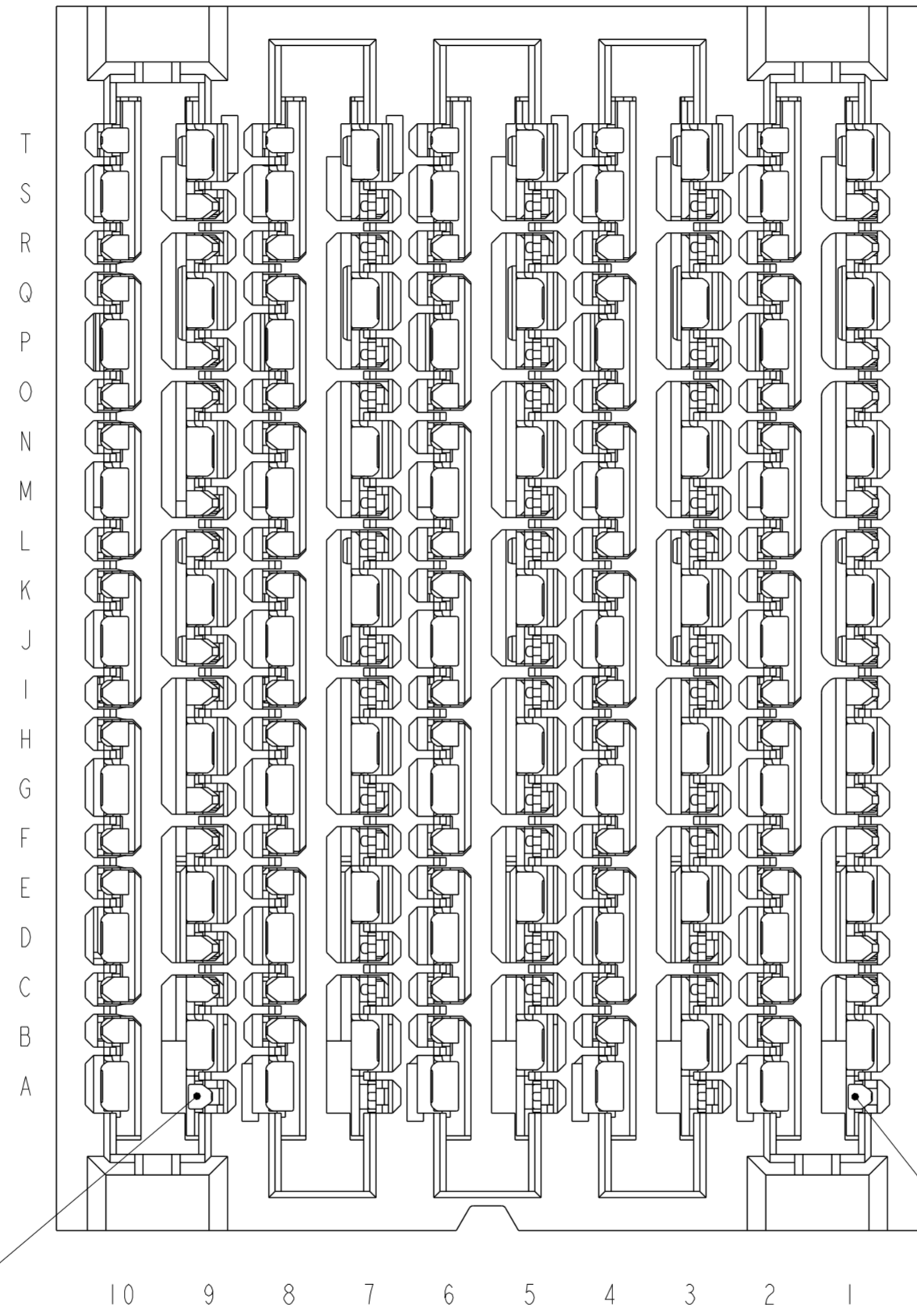

ADVANCED MATE POSITION A9
SEE NOTE 13

ADVANCED MATE POSITION A1
SEE NOTE 13

10131764-201LF
ADVANCED MATE RECEPTACLE
ADVANCED MATE POSITIONS ARE A1 AND A9 ONLY
FOR ALL DIMENSIONS SEE 10131764-101LF ON SHEET 1
SCALE 7:1

Amphenol FCI

© 2016 AFCI

spec ref	SEE NOTES	dr	Will Liu	2014/12/18	projection	MM	size	A2	scale	7:1										
tolerance std	TOLERANCES UNLESS OTHERWISE SPECIFIED	eng	Norman Luo	2017/10/24			ecn no	ELX-DG-28235-1												
ASME Y14.5M		chr	Justin Chen	2017/11/29			rel level	Released												
surface	<table border="1"> <tr> <td rowspan="3">linear</td> <td>0.X</td> <td>±.3</td> </tr> <tr> <td>0.XX</td> <td>±.10</td> </tr> <tr> <td>0.XXX</td> <td>±.050</td> </tr> <tr> <td>angular</td> <td>0°</td> <td>±°</td> </tr> </table>	linear	0.X	±.3	0.XX	±.10	0.XXX	±.050	angular	0°	±°	appr	Heaven Cen	2017/11/30	product family	ExaMAX		rel level	Released	
linear	0.X		±.3																	
	0.XX		±.10																	
	0.XXX	±.050																		
angular	0°	±°																		
				title ExaMAX R.A. RECEPTACLE ASSY 6 PR, 10 IMLA, 200 POS, 21mm		dwg no 10131764 rev B														
		cat. no.		SEE TABLE	Product - Customer Drw		sheet 2 of 11													

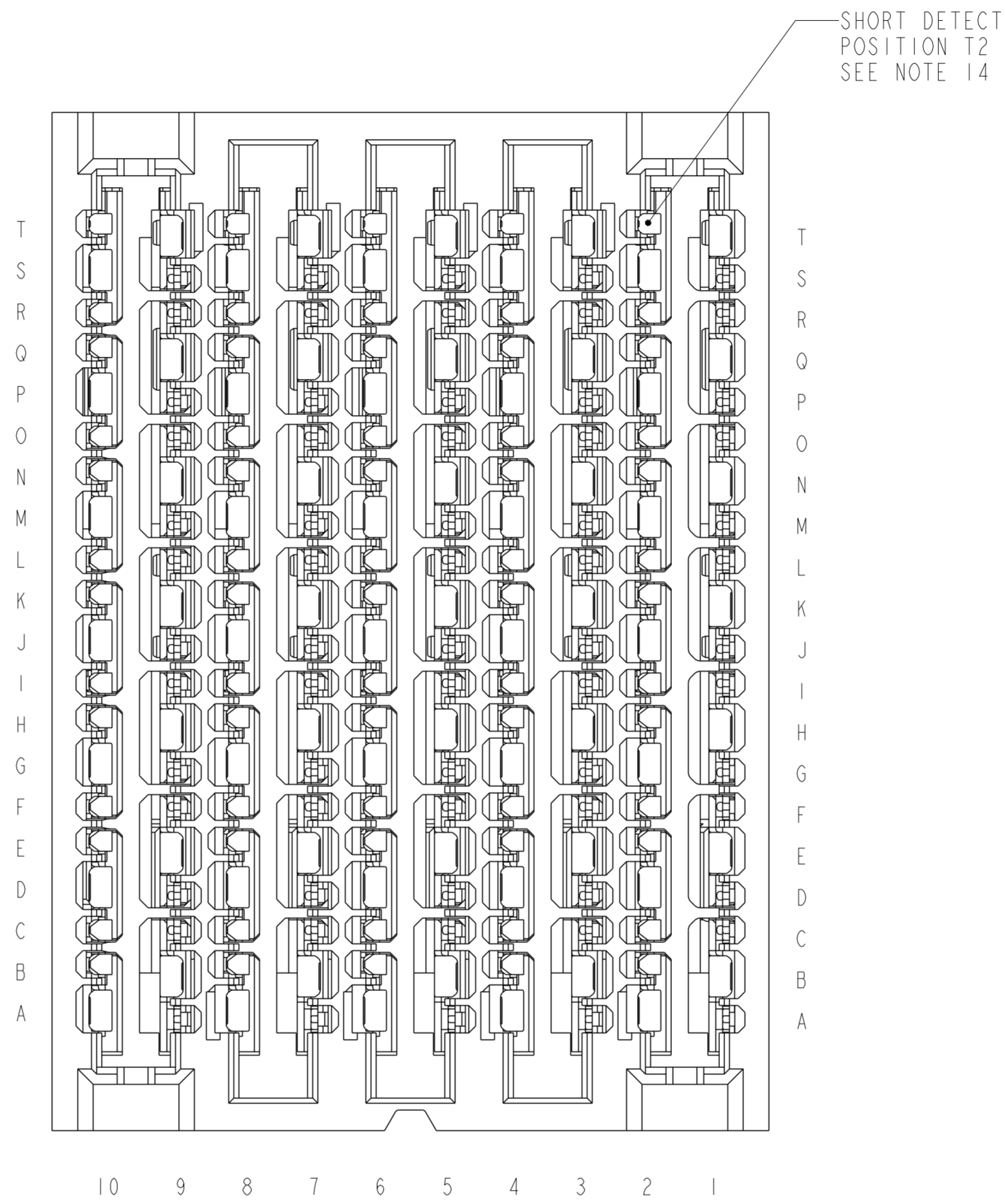

10131764-301LF
 SHORT DETECT RECEPTACLE
 SHORT DETECT POSITION IS T2
 FOR ALL DIMENSIONS SEE 10131764-101LF ON SHEET 1
 SCALE 7:1

Amphenol
FCi

© 2016 AFci

spec ref	SEE NOTES	dr	Will Liu	2014/12/18	projection	MM	size	A2	scale	7:1							
tolerance std	TOLERANCES UNLESS OTHERWISE SPECIFIED	eng	Norman Luo	2017/10/24			ecn no	ELX-DG-28235-1									
ASME Y14.5M		chr	Justin Chen	2017/11/29			rel level	Released									
		appr	Heaven Cen	2017/11/30			product family	ExaMAX									
surface	<table border="1"> <tr> <td rowspan="3">-</td> <td rowspan="3">linear</td> <td>0.X</td> <td>±.3</td> </tr> <tr> <td>0.XX</td> <td>±.10</td> </tr> <tr> <td>0.XXX</td> <td>±.050</td> </tr> <tr> <td></td> <td>angular</td> <td>0°</td> <td>±°</td> </tr> </table>	-	linear	0.X	±.3	0.XX	±.10	0.XXX	±.050		angular	0°	±°		title ExaMAX R.A. RECEPTACLE ASSY 6 PR, 10 IMLA, 200 POS, 21mm	dwg no 10131764	rev B
-	linear			0.X	±.3												
				0.XX	±.10												
		0.XXX	±.050														
	angular	0°	±°														
		cat. no.	SEE TABLE	Product - Customer Drw	sheet 3 of 11												

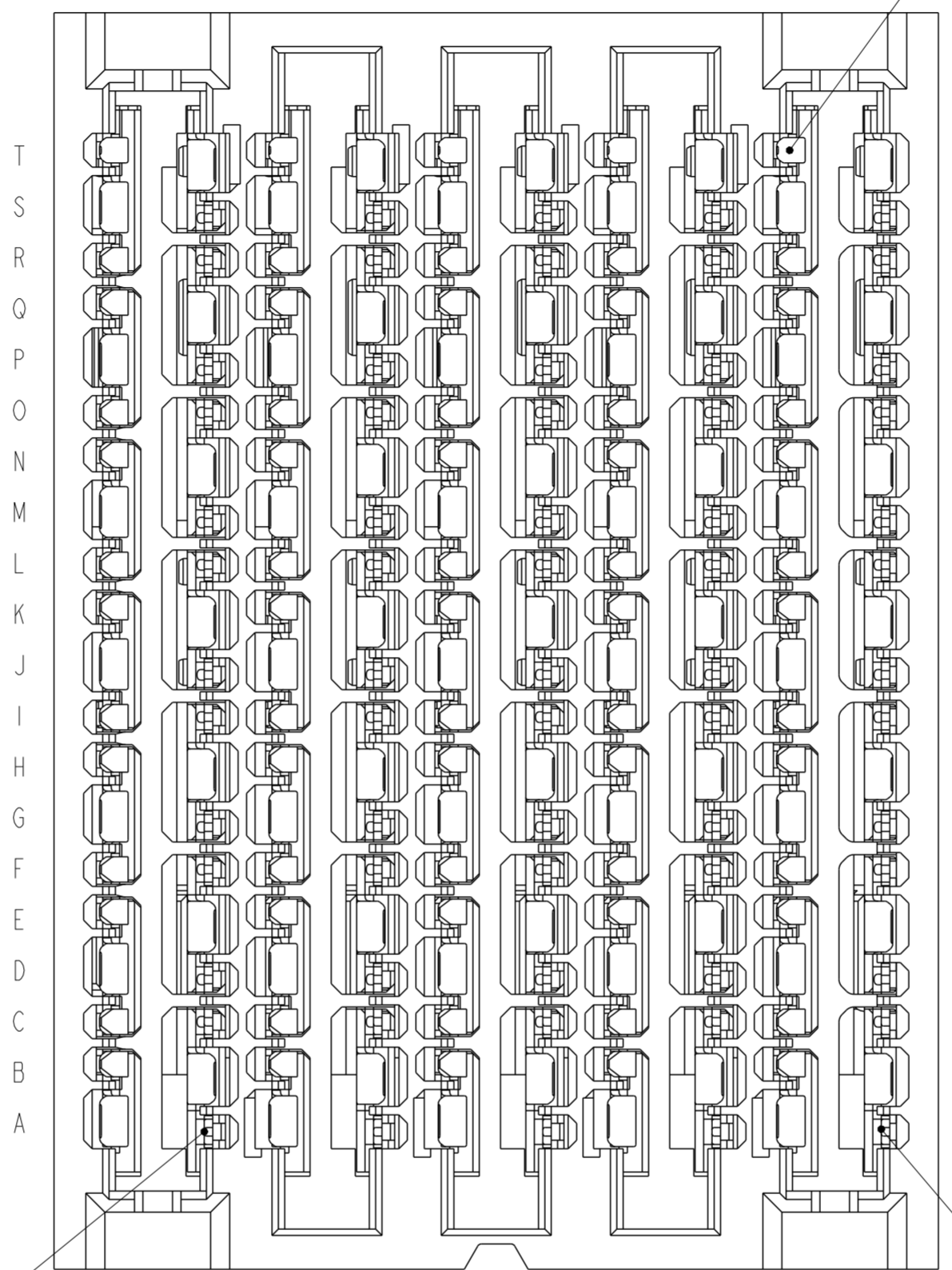

ADVANCED MATE
POSITION A9
SEE NOTE 15

SHORT DETECT
POSITION T2
SEE NOTE 15

ADVANCED MATE
POSITION A1
SEE NOTE 15

10131764-401LF
ADVANCED MATE/SHORT DETECT RECEPTACLE
 ADVANCED MATE POSITIONS ARE POSITIONS A1 AND A9 ONLY
 SHORT DETECT POSITION IS T2
 FOR ALL DIMENSIONS SEE 10131764-101LF ON SHEET 1
 SCALE 7:1

spec ref	SEE NOTES	dr	Will Liu	2014/12/18	projection	MM	size	A2	scale	7:1												
tolerance std	TOLERANCES UNLESS OTHERWISE SPECIFIED	eng	Norman Luo	2017/10/24			ecn no	ELX-DG-28235-1														
ASME Y14.5M		chr	Justin Chen	2017/11/29			rel level	Released														
		appr	Heaven Cen	2017/11/30			product family	ExaMAX														
surface	<table border="1"> <tr> <td>linear</td> <td>0.X</td> <td>±.3</td> </tr> <tr> <td></td> <td>0.XX</td> <td>±.10</td> </tr> <tr> <td></td> <td>0.XXX</td> <td>±.050</td> </tr> <tr> <td>angular</td> <td>0°</td> <td>±°</td> </tr> </table>	linear	0.X	±.3		0.XX	±.10		0.XXX	±.050	angular	0°	±°	Amphenol FCi	title ExaMAX R.A. RECEPTACLE ASSY 6 PR, 10 IMLA, 200 POS, 21mm		dwg no	10131764	rev	B		
linear	0.X	±.3																				
	0.XX	±.10																				
	0.XXX	±.050																				
angular	0°	±°																				
		cat. no.	SEE TABLE	Product - Customer Drw	sheet 4 of 11																	

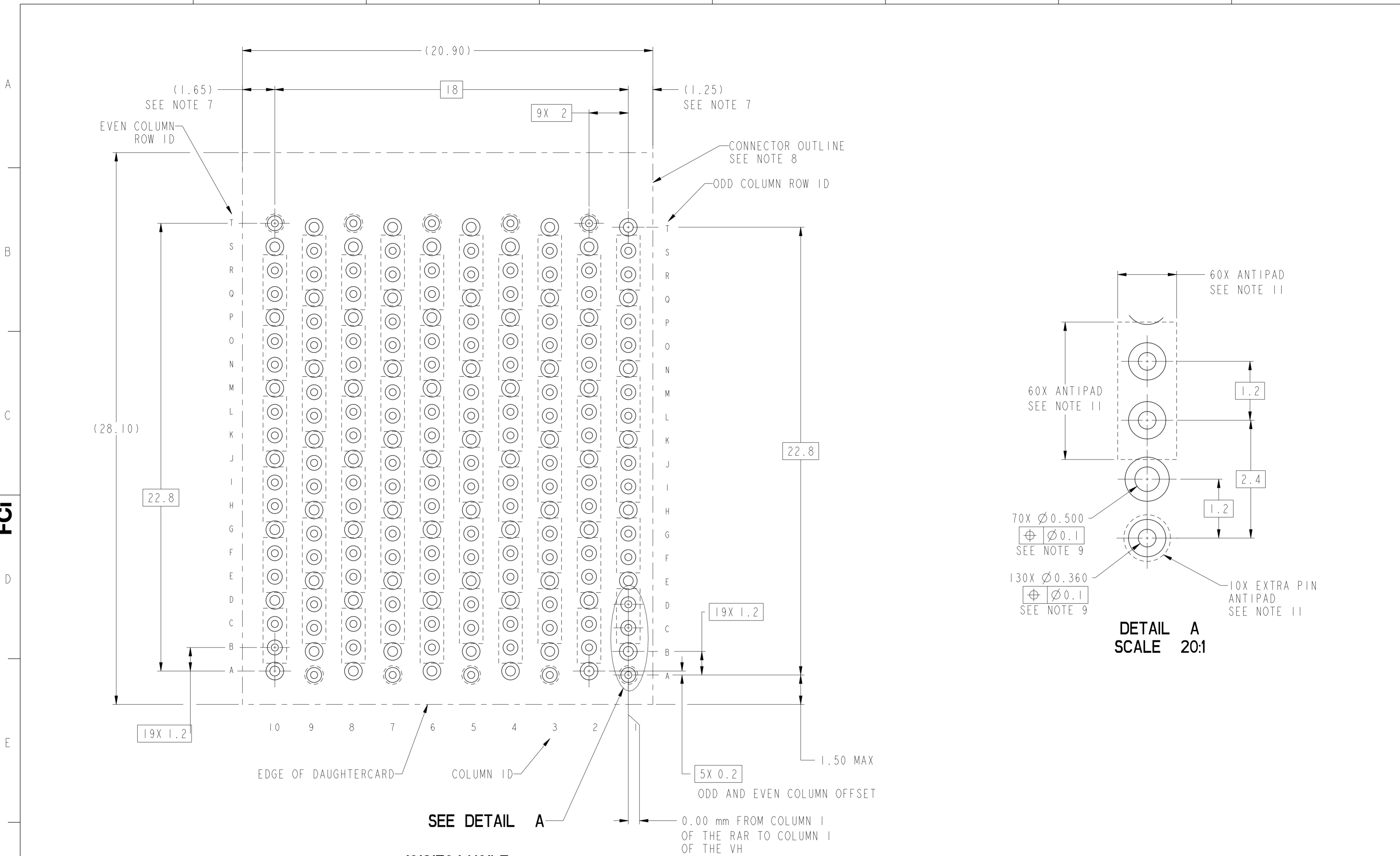

10131764-X01LF
RECOMMENDED PCB LAYOUT
COMPONENT SIDE
NOTES 7, 8, 9, & 11
SCALE 8:1

spec ref	SEE NOTES	dr	Will Liu	2014/12/16	projection	MM	size	A2	scale	8:1
tolerance std	TOLERANCES UNLESS OTHERWISE SPECIFIED	eng	Norman Luo	2017/10/24			ecn no	ELX-DG-28235-1	rel level	Released
ASME Y14.5M		chr	Justin Chen	2017/11/29						
		appr	Heaven Cen	2017/11/30						
surface	linear	0.X	±.3	Amphenol FCI		title ExaMAX R.A. RECEPTACLE ASSY 6 PR, 10 IMLA, 200 POS, 21mm		dwg no 10131764		rev B
		0.XX	±.10							
		0.XXX	±.050							
	angular	0°	±°	cat. no.	Product - Customer Drw		sheet 5 of 11			

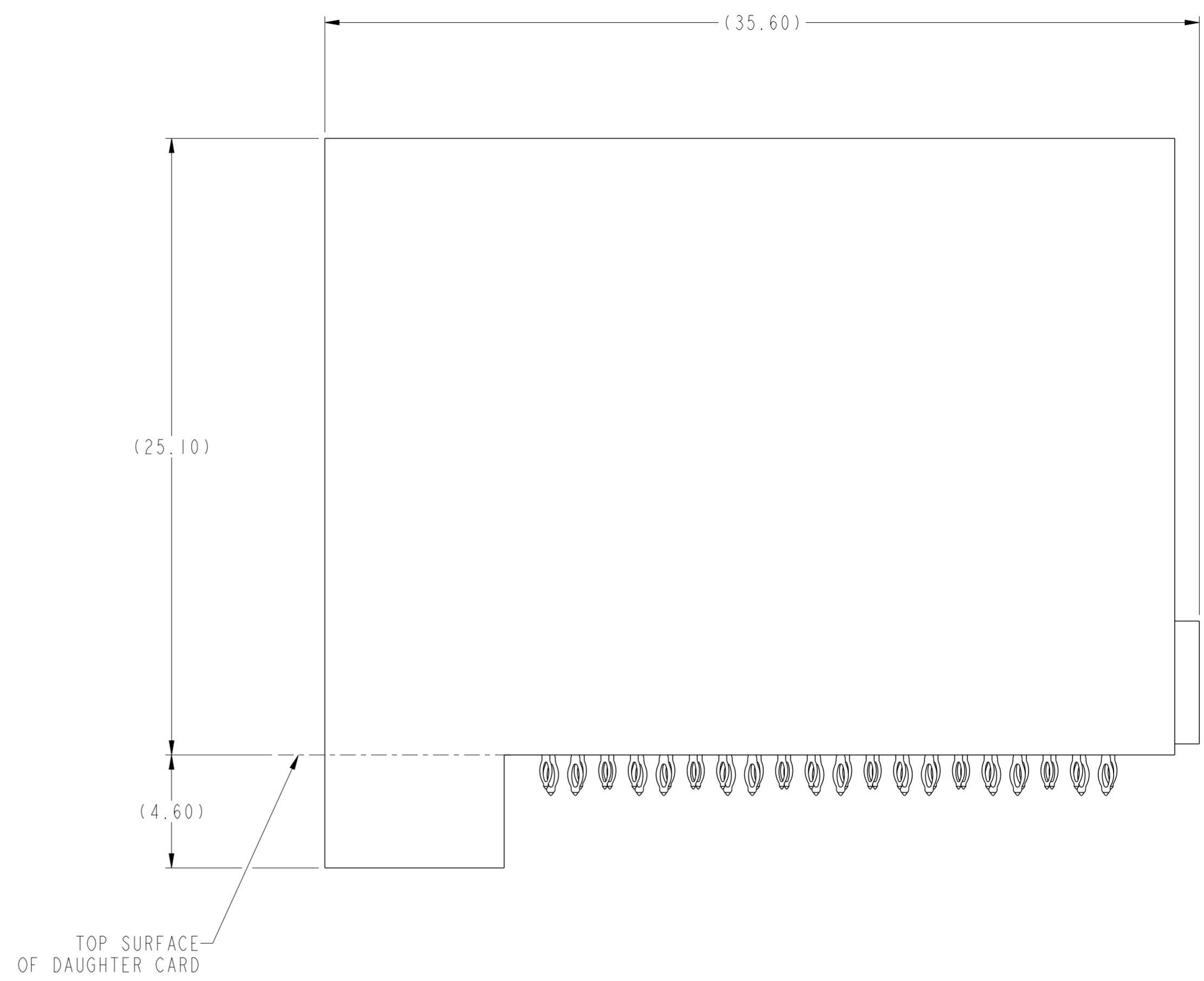
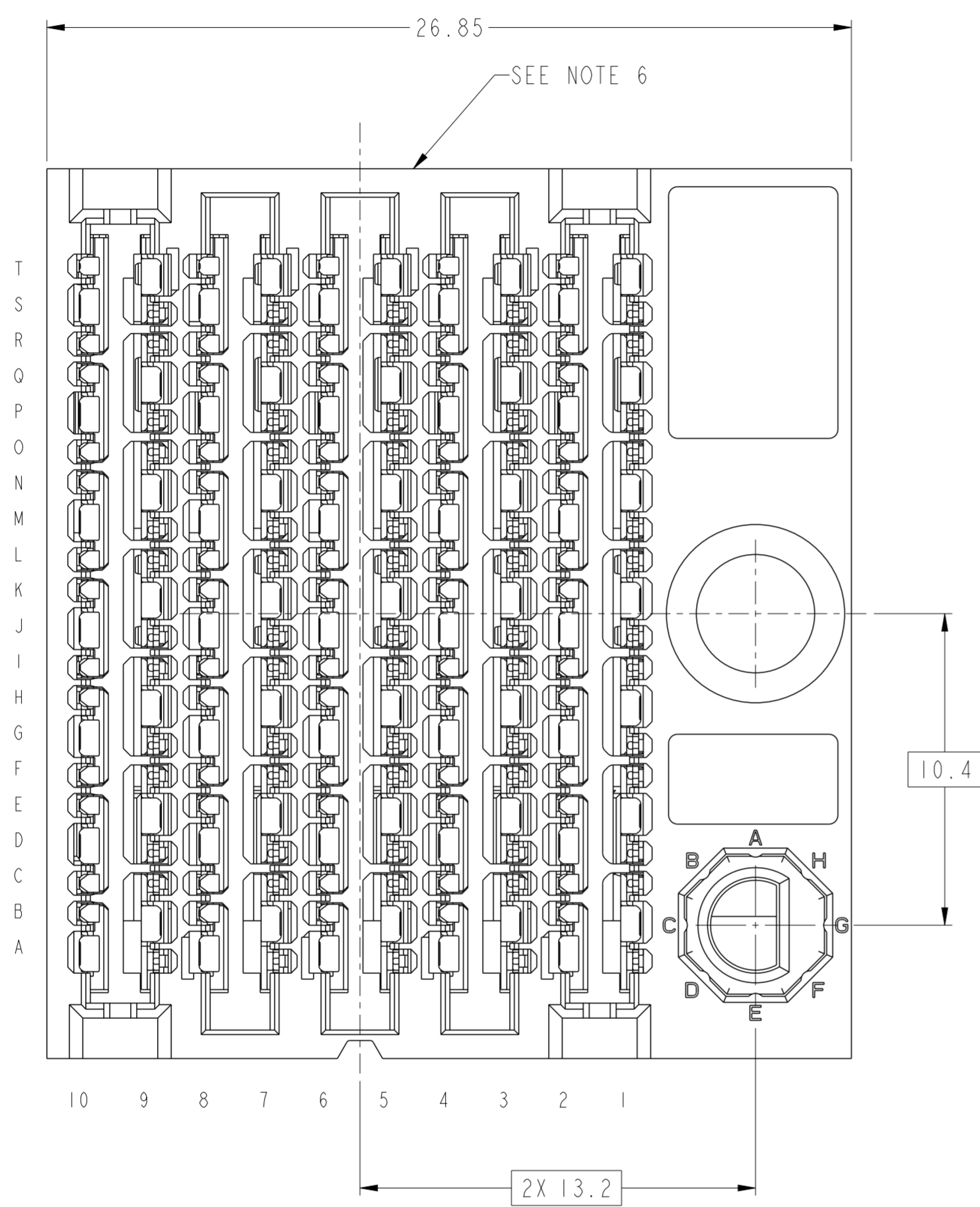

10131764-X1ALF THRU 10131764-X1JLF
 RIGHT GUIDANCE (SEE NOTE 17)
 FOR ALL OTHER DIMENSIONS SEE 10131764-101LF ON SHEET 1
 SCALE 6:1

spec ref	SEE NOTES	dr	Will Liu	2014/12/16	projection	MM	size	A2	scale	6:1											
tolerance std	TOLERANCES UNLESS OTHERWISE SPECIFIED	eng	Norman Luo	2017/10/24			ecn no	ELX-DG-28235-1	rel level	Released											
ASME Y14.5M		chr	Justin Chen	2017/11/29																	
		appr	Heaven Cen	2017/11/30																	
surface	<table border="1"> <tr> <td>linear</td> <td>0.X</td> <td>±.3</td> </tr> <tr> <td></td> <td>0.XX</td> <td>±.10</td> </tr> <tr> <td></td> <td>0.XXX</td> <td>±.050</td> </tr> <tr> <td>angular</td> <td>0°</td> <td>±°</td> </tr> </table>	linear	0.X	±.3		0.XX	±.10		0.XXX	±.050	angular	0°	±°			title ExaMAX R.A. RECEPTACLE ASSY 6 PR, 10 IMLA, 200 POS, 21mm		product family ExaMAX	rel level Released	dwg no 10131764	rev B
linear	0.X	±.3																			
	0.XX	±.10																			
	0.XXX	±.050																			
angular	0°	±°																			
		cat. no.		SEE TABLE	Product - Customer Drw		sheet 6 of 11														

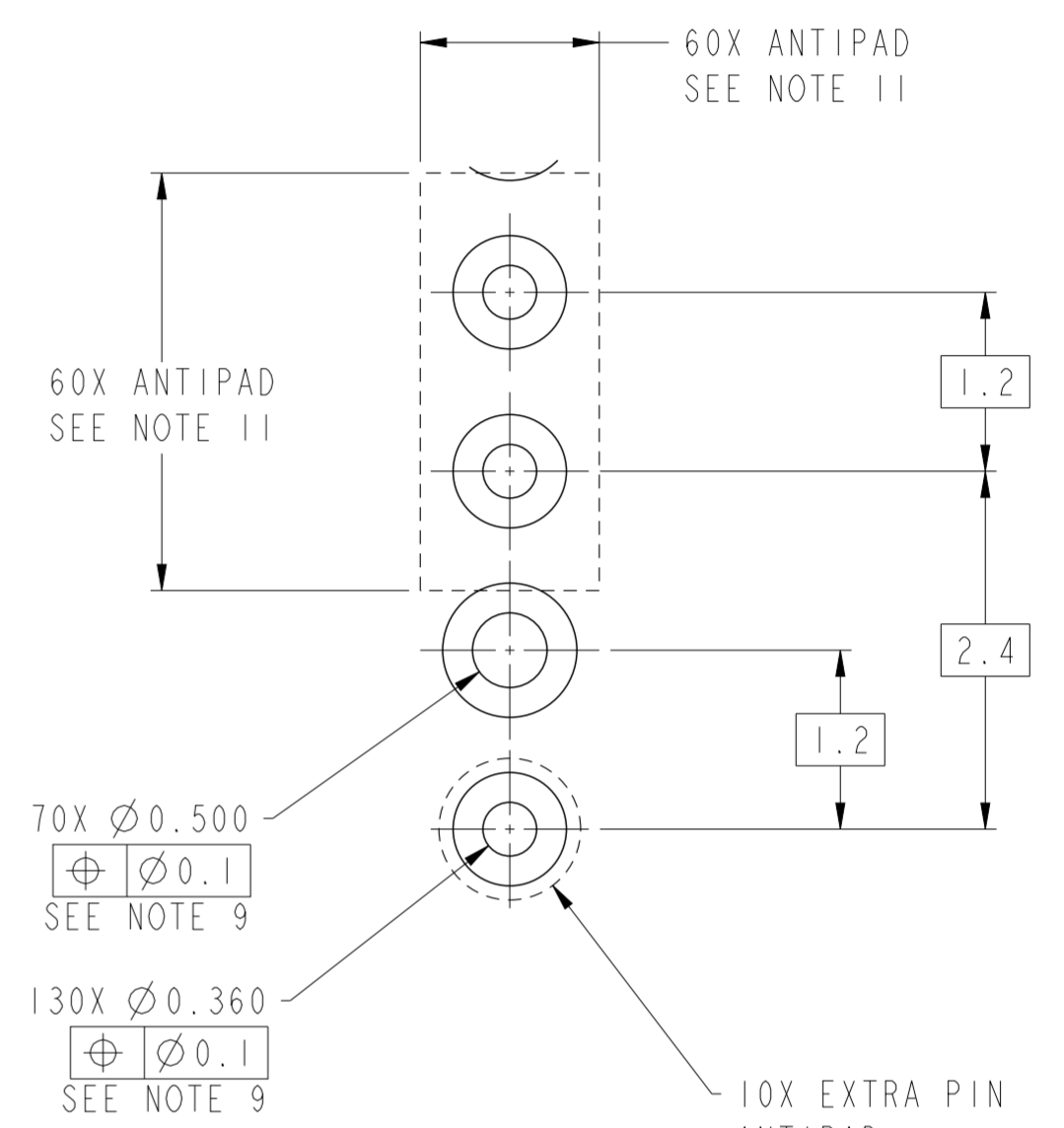
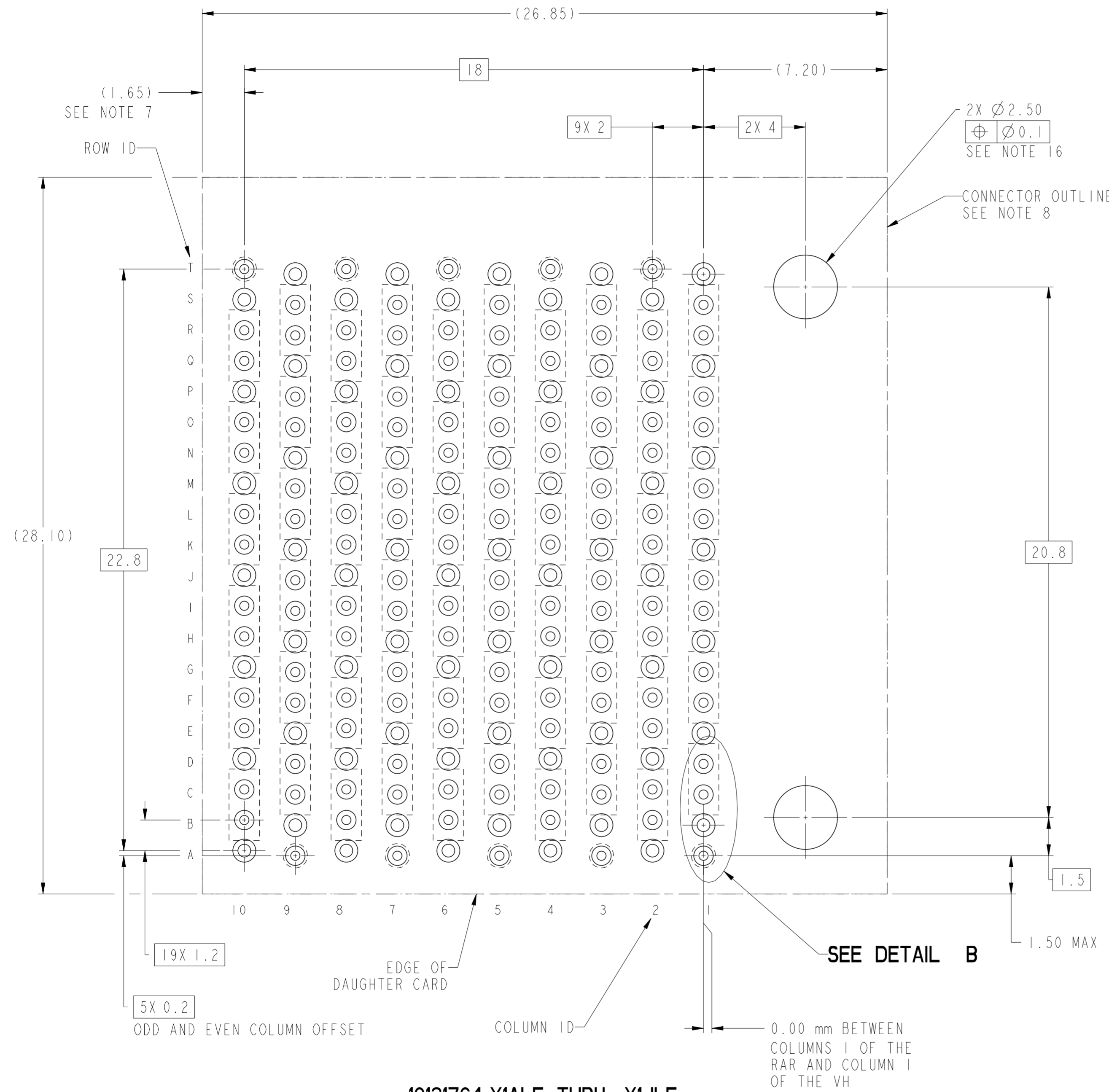

**10131764-X1ALF THRU -X1JLF
RECOMMENDED PCB LAYOUT
COMPONENT SIDE
NOTES 7, 8, 9, 11 & 16
SCALE 8:1**

spec ref	SEE NOTES	dr	Will Liu	2014/12/16	projection	MM	size	A2	scale	1:1
tolerance std	TOLERANCES UNLESS OTHERWISE SPECIFIED	eng	Norman Luo	2017/10/24			ecn no	ELX-DG-28235-1	rel level	Released
ASME Y14.5M		chr	Justin Chen	2017/11/29						
		appr	Heaven Cen	2017/11/30						
surface	linear	0.X	±.3		product family		title ExaMAX R.A. RECEPTACLE ASSY 6 PR, 10 IMLA, 200 POS, 21mm	dwg no 10131764	rev B	
		0.XX	±.10		cat. no.					Product - Customer Drw
		0.XXX	±.050		sheet 7 of 11					
	angular	0°	±°	PDS: Rev :B		STATUS:Released		Printed: Dec 11, 2017		

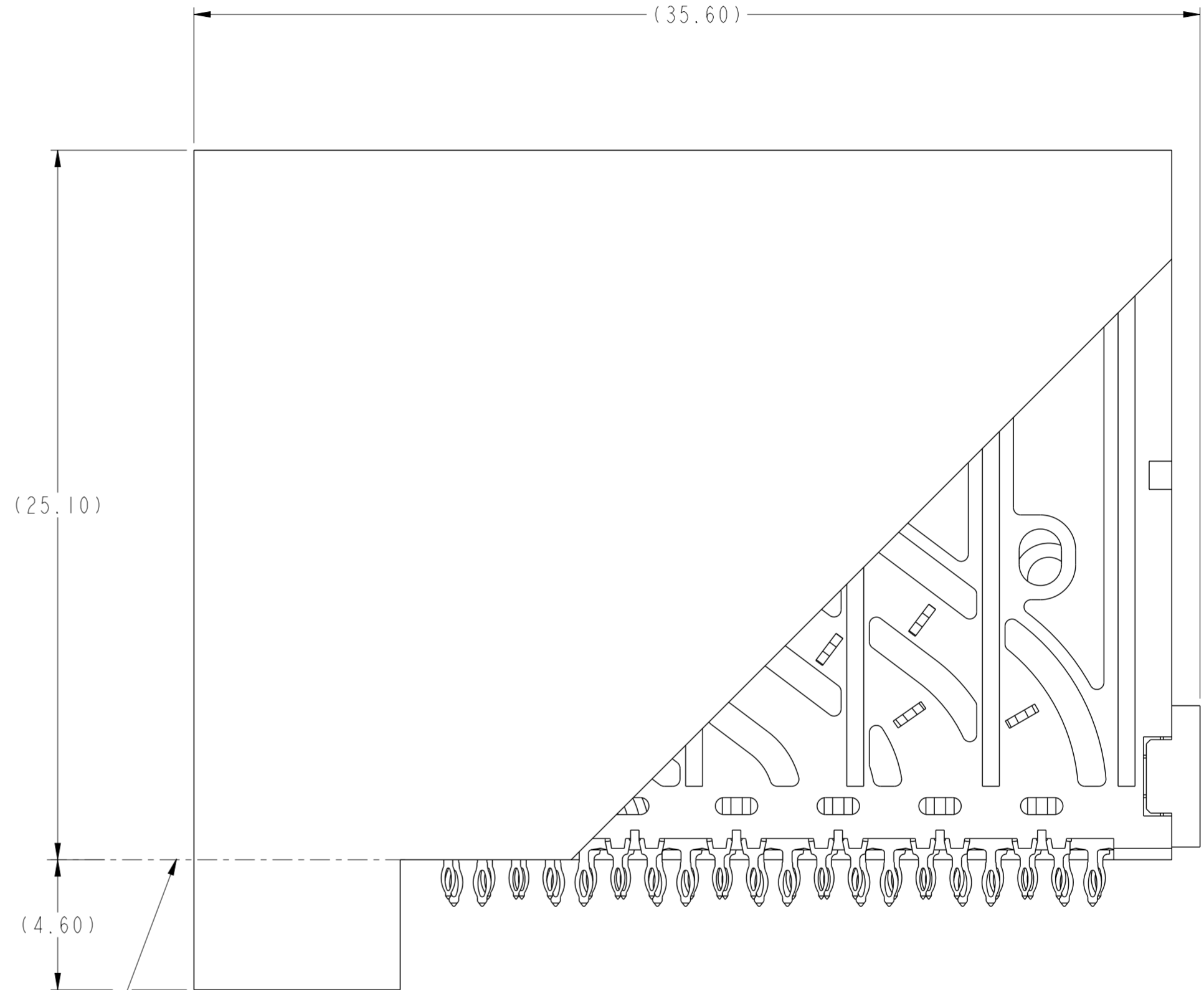
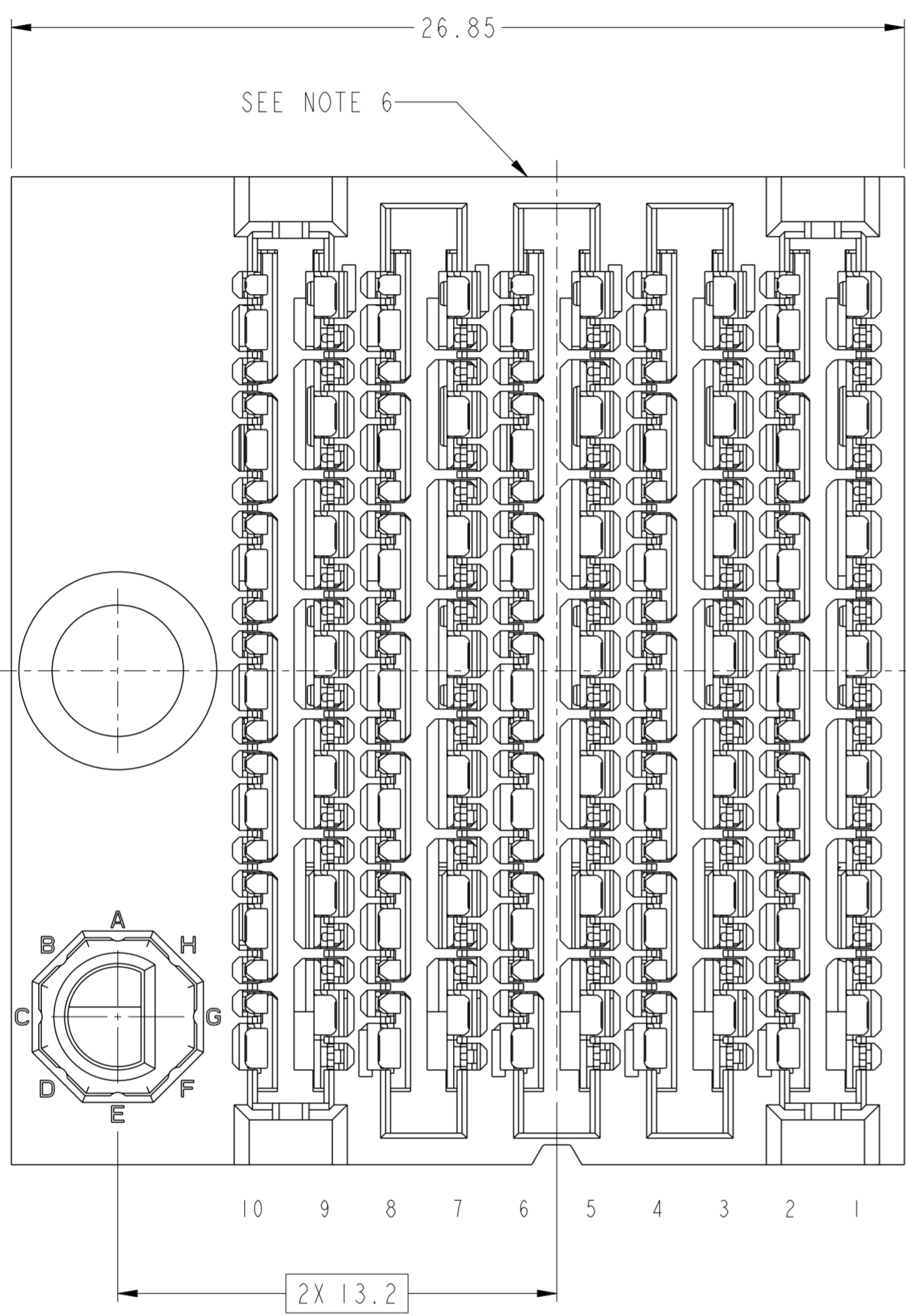

10131764-X2ALF THRU 10131764-X2JLF
LEFT GUIDANCE (SEE NOTE 17)
FOR ALL OTHER DIMENSIONS SEE 10131764-101LF ON SHEET 1
SCALE 6:1

spec ref	SEE NOTES	dr	Will Liu	2014/12/16	projection	MM	size	A2	scale	6:1												
tolerance std	TOLERANCES UNLESS OTHERWISE SPECIFIED	eng	Norman Luo	2017/10/24			ecn no	ELX-DG-28235-1	rel level	Released												
ASME Y14.5M		chr	Justin Chen	2017/11/29																		
		appr	Heaven Cen	2017/11/30																		
surface	<table border="1"> <tr> <td>linear</td> <td>0.X</td> <td>±.3</td> </tr> <tr> <td></td> <td>0.XX</td> <td>±.10</td> </tr> <tr> <td></td> <td>0.XXX</td> <td>±.050</td> </tr> <tr> <td>angular</td> <td>0°</td> <td>±°</td> </tr> </table>	linear	0.X	±.3		0.XX	±.10		0.XXX	±.050	angular	0°	±°			title ExaMAX R.A. RECEPTACLE ASSY 6 PR, 10 IMLA, 200 POS, 21mm		product family ExaMAX	rel level Released	cat. no. SEE TABLE	Product - Customer Drw	sheet 8 of 11
linear	0.X	±.3																				
	0.XX	±.10																				
	0.XXX	±.050																				
angular	0°	±°																				
							dwg no 10131764			rev B												

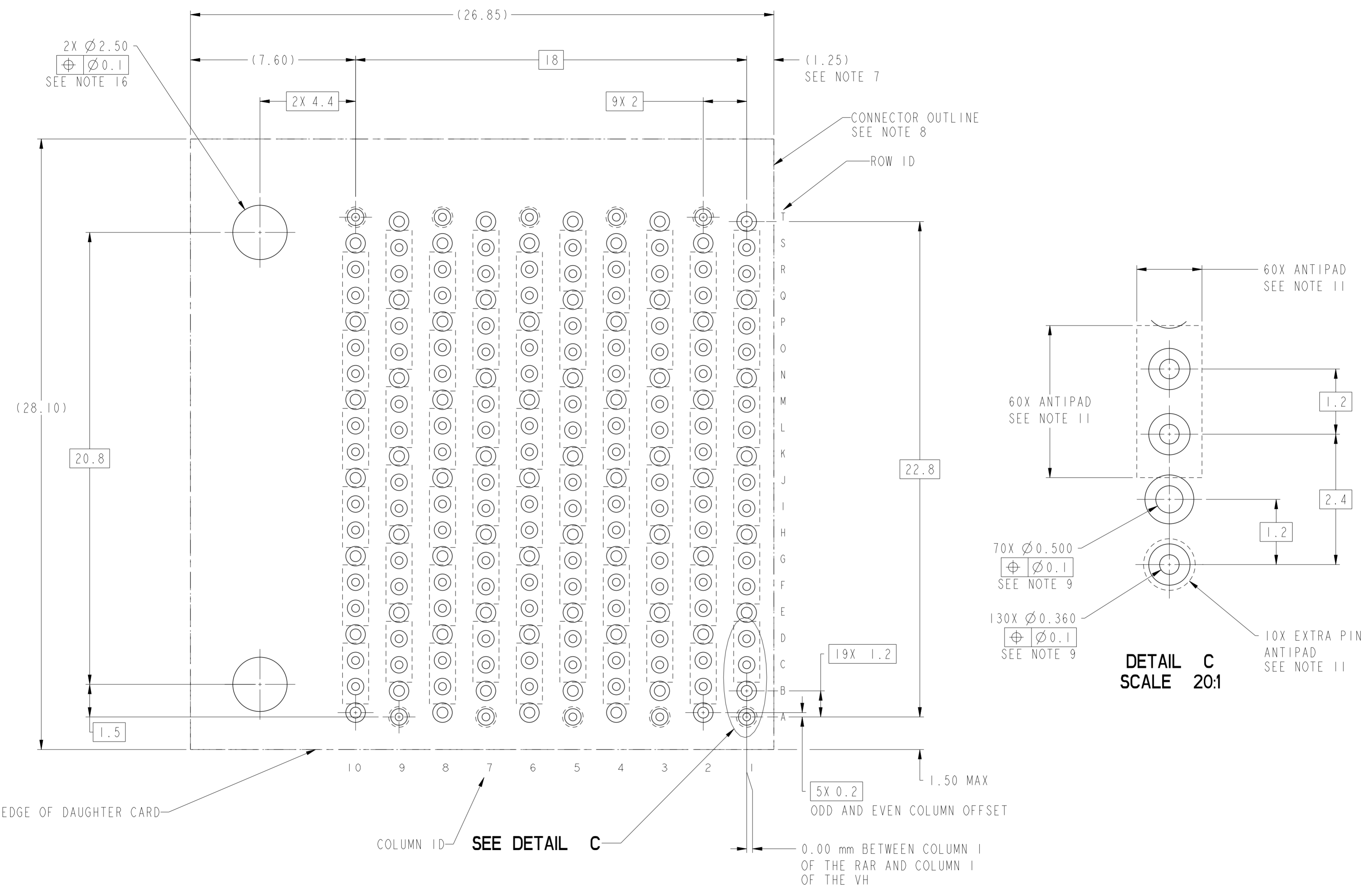

10131764-X2ALF THRU -X2JLF
RECOMMENDED PCB LAYOUT
COMPONENT SIDE
NOTES 7, 8, 9, 11 & 16
SCALE 8:1

spec ref	SEE NOTES	dr	Will Liu	2014/12/16	projection	MM	size	A2	scale	8:1	
tolerance std	TOLERANCES UNLESS OTHERWISE SPECIFIED	eng	Norman Luo	2017/10/24			ecn no	ELX-DG-28235-1	rel level	Released	
ASME Y14.5M		chr	Justin Chen	2017/11/29							
		appr	Heaven Cen	2017/11/30							
surface	linear	0.X	±.3		product family -	title ExaMAX R.A. RECEPTACLE ASSY 6 PR, 10 IMLA, 200 POS, 21mm	dwg no 10131764	rev B	cat. no. -	Product - Customer Drw	sheet 9 of 11
		0.XX	±.10								
		0.XXX	±.050								
	angular	0°	±°								

10131764 - Y Y Y L F

ASSEMBLY PART NUMBER	DESCRIPTION
10131764-1YYLF	STANDARD MATE
10131764-2YYLF	ADVANCED MATE
10131764-3YYLF	SHORT DETECT
10131764-4YYLF	ADVANCED MATE & SHORT DETECT

MODULE DESCRIPTION	DESIGNATION REPRESENTED IN DASH NUMBER										BASE MODEL
	WITHOUT END GUIDES MODULE (SEE SHEET 1)	01									
RIGHT GUIDANCE MODULE (SEE SHEET 6)	1A	1B	1C	1D	1E	1F	1G	1H	1J (NO KEY)		
LEFT GUIDANCE MODULE (SEE SHEET 8)	2A	2B	2C	2D	2E	2F	2G	2H	2J (NO KEY)		

Amphenol FCI

© 2016 AFCI

spec ref	SEE NOTES	dr	Will Liu	2014/12/16	projection	MM	size	A2	scale	1:1
tolerance std	TOLERANCES UNLESS OTHERWISE SPECIFIED	eng	Norman Luo	2017/10/24		←→	ecn no	ELX-DG-28235-1	rel level	Released
ASME Y14.5M		chr	Justin Chen	2017/11/29						
		appr	Heaven Cen	2017/11/30						
surface	linear	0.X	±.3	Amphenol FCI	title	ExaMAX R.A. RECEPTACLE ASSY	cat. no.	-	Product - Customer Drw	sheet 10 of 11
✓		0.XX	±.10							
		0.XXX	±.050							
	angular	0°	±°							

PDS: Rev :B

STATUS:Released

Printed: Dec 11, 2017

NOTES:

- ① - CONNECTOR MATERIALS:
HOUSING: HIGH TEMP THERMOPLASTIC, BLACK, UL94-V0
IMLA PLASTIC: HIGH TEMP THERMOPLASTIC, BLACK, UL94-V0
CONTACT: COPPER ALLOY
ORGANIZER: HIGH TEMP THERMOPLASTIC, BLACK, UL94-V0
- 2 - CONTACT PLATING:
SEPARABLE INTERFACE:
PERFORMANCE-BASED PLATING, QUALIFIED TO MEET THE REQUIREMENTS OF FCI PRODUCT SPECIFICATION GS-12-1096 INCLUDING TELCORDIA GR-1217-CORE (NOVEMBER 1995) CENTRAL OFFICE TEST SEQUENCE

PRESS-FIT TAILS: TIN OVER NICKEL (LEAD FREE)
- 3 - PRODUCT SPECIFICATION: GS-12-1096
- 4 - APPLICATION SPECIFICATION GS-20-0361.
- 5 - PACKAGING MEETS GS-14-920 LEAD FREE LABELING SPECIFICATION.
- ⑥ - PRODUCT MARKING, (PART NUMBER & LOT CODE), ON THIS SURFACE.
- ⑦ - THE MINIMUM VIA SPACING BETWEEN STACKED CONNECTORS IS 3.0 MM FOR THIS RAR AND THE MATING HEADER. REFER TO THE APPLICATION SPECIFICATION FOR DETAILS
- ⑧ - CONNECTOR OUTLINE MAY BE SCREEN PRINTED ONTO CUSTOMER PCB TO BE USED AS A GUIDE FOR MANUAL CONNECTOR PLACEMENT.
- ⑨ - REFER TO CUSTOMER DRAWING 10119933 FOR INFORMATION ON PCB HOLE DIAMETERS AND PLATING OPTIONS
- 10 - THIS PRODUCT MEETS THE EUROPEAN UNION DIRECTIVES & OTHER COUNTRY REGULATIONS AS DESCRIBED IN GS-47-0004.
- ⑪ - REFER TO ROUTING GUIDE GS-20-0511 FOR RECOMMENDATIONS ON OPTIMIZATION OF FOOTPRINT AND TRACE ROUTING LAYOUT.
- 12 - THE HOUSING WILL WITHSTAND EXPOSURE TO 260° C PEAK TEMPERATURE FOR 10-30 SECONDS IN A CONVECTION, INFRA-RED OR VAPOR PHASE REFLOW OVEN.
- ⑬ - THE ADVANCED MATE RECEPTACLE, 10131764-2XXLF, WHEN MATED WITH AN ADVANCED MATE VERTICAL HEADER OR AN ADVANCED MATE RIGHT-ANGLE HEADER, WILL PROVIDE 2 PAIRS OF MATING CONTACTS THAT MATE 0.75mm BEFORE THE REMAINDER OF THE SIGNAL AND GROUND CONTACTS.
- ⑭ - THE SHORT DETECT RECEPTACLE, 10131764-3XXLF, WHEN MATED WITH A STANDARD MATE VERTICAL HEADER OR A STANDARD MATE RIGHT-ANGLE HEADER WILL PROVIDE 1 PAIR OF MATING CONTACTS THAT MATE 1.00mm AFTER THE REMAINDER OF THE SIGNAL AND GROUND CONTACTS.
- ⑮ - THE ADVANCE MATE/SHORT DETECT RECEPTACLE, 10131764-4XXLF, WHEN MATED WITH AN ADVANCED MATE VERTICAL HEADER OR AN ADVANCED MATE RIGHT-ANGLE HEADER WILL PROVIDE 2 PAIRS OF MATING CONTACTS THAT MATE 0.75mm BEFORE THE REMAINDER OF THE SIGNAL AND GROUND CONTACTS AND 1 PAIR OF MATING CONTACTS THAT MATE 1.00mm AFTER THE REMAINDER OF THE SIGNAL AND GROUND CONTACTS.
- ⑯ - FOR CONNECTORS WITH EITHER A RIGHT OR LEFT GUIDE MODULE, TWO PHILLIPS PAN HEAD M2 HOLD DOWN SCREWS MUST BE USED TO SECURE THE CONNECTOR TO THE PCB. THE SCREW LENGTH SHALL BE 2.0-6.0mm PLUS THE THICKNESS OF THE BOARD. SCREWS ARE NOT PROVIDED WITH CONNECTOR.
- ⑰ - LEFT / RIGHT INTEGRATED GUIDE ORIENTATION IS DETERMINED BY THE LOCATION OF THE GUIDE FEATURES WHEN LOOKING AT THE MATING FACE OF THE RIGHT ANGLE RECEPTACLE. THE LEFT / RIGHT DESIGNATION OF THE MATING HEADER IS DEFINED BY THE RIGHT ANGLE RECEPTACLE THAT IT MATES WITH (i.e. A RIGHT GUIDE VERTICAL HEADER MATES WITH A RIGHT GUIDE RIGHT ANGLE RECEPTACLE.)
- ⑱ - ALL GROUND CONTACTS WITHIN A COLUMN ARE COMMONED.

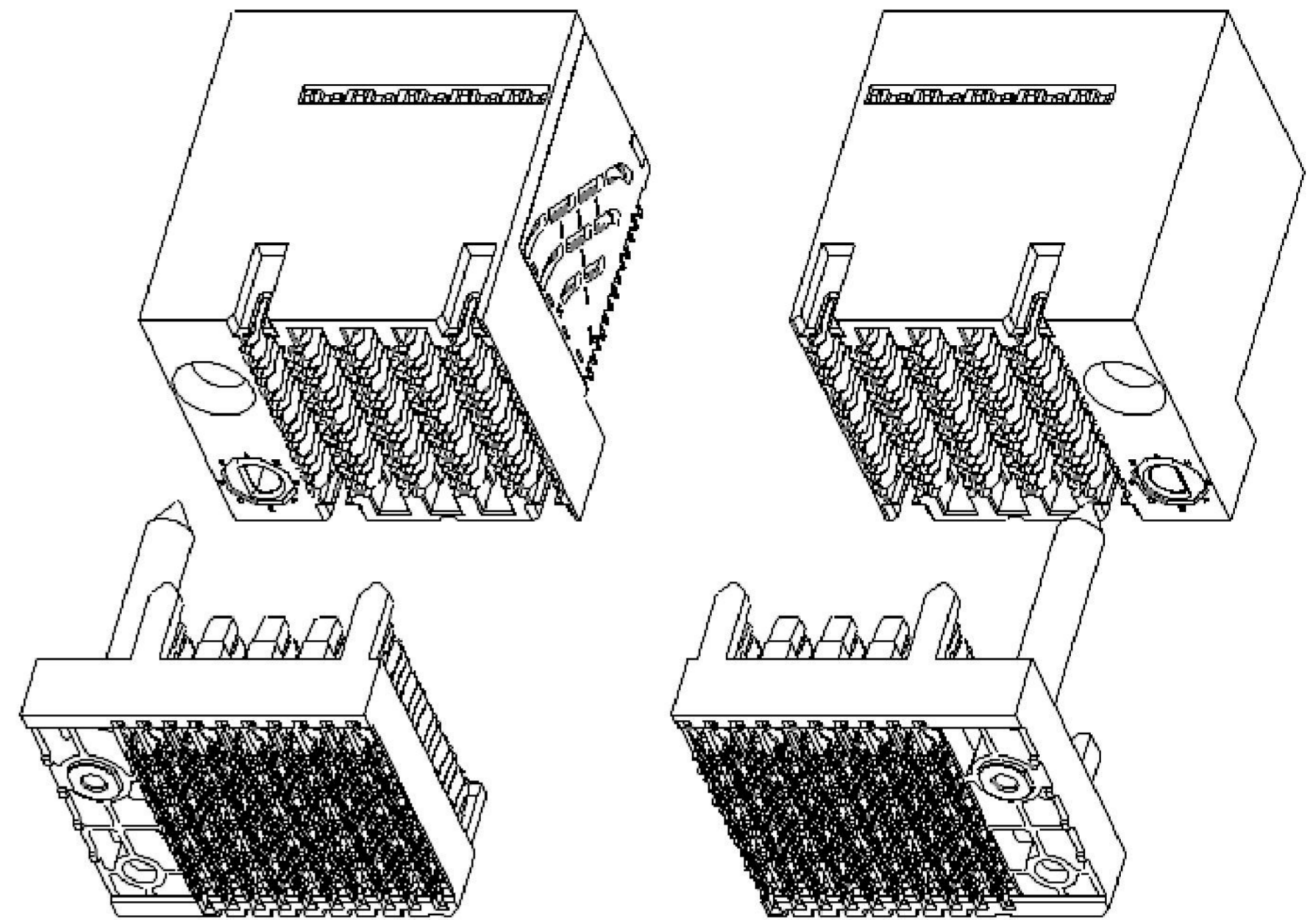

LEFT GUIDE

RIGHT GUIDE

**ExaMAX INTEGRATED GUIDE ORIENTATION
4 PAIR 10 IMLA CONNECTORS SHOWN FOR REFERENCE ONLY
SEE NOTE 17**

spec ref	SEE NOTES	dr	Will Liu	2014/12/16	projection	MM	size	A2	scale	6:1												
tolerance std	TOLERANCES UNLESS OTHERWISE SPECIFIED	eng	Norman Luo	2017/10/24			ecn no	ELX-DG-28235-1														
ASME Y14.5M		chr	Justin Chen	2017/11/29			rel level	Released														
surface	<table border="1"> <tr> <td>linear</td> <td>0.X</td> <td>±.3</td> </tr> <tr> <td></td> <td>0.XX</td> <td>±.10</td> </tr> <tr> <td></td> <td>0.XXX</td> <td>±.050</td> </tr> <tr> <td>angular</td> <td>0°</td> <td>±°</td> </tr> </table>	linear	0.X	±.3		0.XX	±.10		0.XXX	±.050	angular	0°	±°	appr	Heaven Cen	2017/11/30	product family	ExaMAX		rel level	Released	
linear	0.X	±.3																				
	0.XX	±.10																				
	0.XXX	±.050																				
angular	0°	±°																				
				title ExaMAX R.A. RECEPTACLE ASSY 6 PR, 10 IMLA, 200 POS, 21mm		dwg no	10131764		rev	B												
				cat. no.	SEE TABLE	Product - Customer Drw		sheet 11 of 11														



Компания «ЭлектроПласт» предлагает заключение долгосрочных отношений при поставках импортных электронных компонентов на взаимовыгодных условиях!

Наши преимущества:

- Оперативные поставки широкого спектра электронных компонентов отечественного и импортного производства напрямую от производителей и с крупнейших мировых складов;
- Поставка более 17-ти миллионов наименований электронных компонентов;
- Поставка сложных, дефицитных, либо снятых с производства позиций;
- Оперативные сроки поставки под заказ (от 5 рабочих дней);
- Экспресс доставка в любую точку России;
- Техническая поддержка проекта, помощь в подборе аналогов, поставка прототипов;
- Система менеджмента качества сертифицирована по Международному стандарту ISO 9001;
- Лицензия ФСБ на осуществление работ с использованием сведений, составляющих государственную тайну;
- Поставка специализированных компонентов (Xilinx, Altera, Analog Devices, Intersil, Interpoint, Microsemi, Aeroflex, Peregrine, Syfer, Eurofarad, Texas Instrument, Miteq, Cobham, E2V, MA-COM, Hittite, Mini-Circuits, General Dynamics и др.);

Помимо этого, одним из направлений компании «ЭлектроПласт» является направление «Источники питания». Мы предлагаем Вам помощь Конструкторского отдела:

- Подбор оптимального решения, техническое обоснование при выборе компонента;
- Подбор аналогов;
- Консультации по применению компонента;
- Поставка образцов и прототипов;
- Техническая поддержка проекта;
- Защита от снятия компонента с производства.



Как с нами связаться

Телефон: 8 (812) 309 58 32 (многоканальный)

Факс: 8 (812) 320-02-42

Электронная почта: org@eplast1.ru

Адрес: 198099, г. Санкт-Петербург, ул. Калинина, дом 2, корпус 4, литера А.