

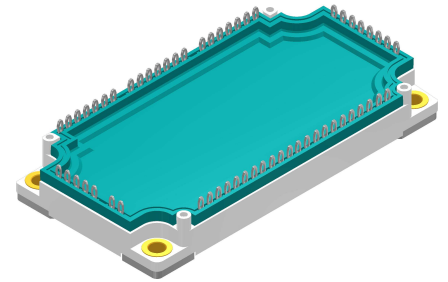
High Voltage Standard Rectifier Module

3~ Rectifier
$V_{RRM} = 2200\text{ V}$
$I_{DAV} = 660\text{ A}$
$I_{FSM} = 5000\text{ A}$

3~ Rectifier Bridge + NTC

Part number

MDNA660U2200PTEH



Backside: isolated

 E72873



Features / Advantages:

- Package with DCB ceramic
- Improved temperature and power cycling
- Planar passivated chips
- Very low forward voltage drop
- Very low leakage current

Applications:

- Diode for main rectification
- For three phase bridge configurations
- Supplies for DC power equipment
- Input rectifiers for PWM inverter
- Battery DC power supplies
- Field supply for DC motors

Package: E3-Pack

- Isolation Voltage: 3600 V~
- Industry standard outline
- RoHS compliant
- PressFit-Pins for PCB mounting
- Height: 17 mm
- Base plate: Copper internally DCB isolated
- Advanced power cycling
- Phase Change Material available

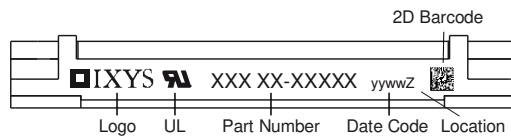
Disclaimer Notice

Information furnished is believed to be accurate and reliable. However, users should independently evaluate the suitability of and test each product selected for their own applications. Littelfuse products are not designed for, and may not be used in, all applications. Read complete Disclaimer Notice at www.littelfuse.com/disclaimer-electronics.



Rectifier				Ratings			
Symbol	Definition	Conditions		min.	typ.	max.	Unit
V_{RSM}	max. non-repetitive reverse blocking voltage			$T_{VJ} = 25^{\circ}C$		2300	V
V_{RRM}	max. repetitive reverse blocking voltage			$T_{VJ} = 25^{\circ}C$		2200	V
I_R	reverse current	$V_R = 2200$ V		$T_{VJ} = 25^{\circ}C$		400	μA
		$V_R = 2200$ V		$T_{VJ} = 150^{\circ}C$		6	mA
V_F	forward voltage drop	$I_F = 220$ A		$T_{VJ} = 25^{\circ}C$		1.28	V
		$I_F = 660$ A				1.95	V
		$I_F = 220$ A		$T_{VJ} = 125^{\circ}C$		1.19	V
		$I_F = 660$ A				1.95	V
I_{DAV}	bridge output current	$T_C = 85^{\circ}C$		$T_{VJ} = 150^{\circ}C$		660	A
		rectangular	$d = \frac{1}{3}$				
V_{FO}	threshold voltage			$T_{VJ} = 150^{\circ}C$		0.77	V
r_F	slope resistance					1.8	m Ω
		} for power loss calculation only					
R_{thJC}	thermal resistance junction to case					0.15	K/W
R_{thCH}	thermal resistance case to heatsink				0.075		K/W
P_{tot}	total power dissipation			$T_C = 25^{\circ}C$		830	W
I_{FSM}	max. forward surge current	$t = 10$ ms; (50 Hz), sine		$T_{VJ} = 45^{\circ}C$		5.00	kA
		$t = 8,3$ ms; (60 Hz), sine		$V_R = 0$ V		5.40	kA
		$t = 10$ ms; (50 Hz), sine		$T_{VJ} = 150^{\circ}C$		4.25	kA
		$t = 8,3$ ms; (60 Hz), sine		$V_R = 0$ V		4.59	kA
I^2t	value for fusing	$t = 10$ ms; (50 Hz), sine		$T_{VJ} = 45^{\circ}C$		125.0	kA ² s
		$t = 8,3$ ms; (60 Hz), sine		$V_R = 0$ V		121.3	kA ² s
		$t = 10$ ms; (50 Hz), sine		$T_{VJ} = 150^{\circ}C$		90.3	kA ² s
		$t = 8,3$ ms; (60 Hz), sine		$V_R = 0$ V		87.6	kA ² s
C_J	junction capacitance	$V_R = 700$ V; $f = 1$ MHz		$T_{VJ} = 25^{\circ}C$		158	pF

Package E3-Pack		Ratings				
Symbol	Definition	Conditions	min.	typ.	max.	Unit
I_{RMS}	RMS current	per terminal			30	A
T_{VJ}	virtual junction temperature		-40		175	°C
T_{op}	operation temperature		-40		150	°C
T_{stg}	storage temperature		-40		125	°C
Weight				270		g
M_D	mounting torque		3		6	Nm
$d_{Spp/App}$	creepage distance on surface striking distance through air	terminal to terminal	6.0			mm
$d_{Spb/Apb}$		terminal to backside	12.0			mm
V_{ISOL}	isolation voltage	t = 1 second t = 1 minute	3600 3000			V V
		50/60 Hz, RMS; $I_{ISOL} \leq 1$ mA				



Part description

M = Module
 D = Diode
 N = High Voltage Standard Rectifier
 A = ($\geq 2000V$)
 660 = Current Rating [A]
 U = 3- Rectifier Bridge
 2200 = Reverse Voltage [V]
 PT = PressFit-Pin, Thermistor
 EH = E3-Pack
 - = Hyphen
 PC = Phase Change Material

Ordering	Ordering Number	Marking on Product	Delivery Mode	Quantity	Code No.
Standard	MDNA660U2200PTEH	MDNA660U2200PTEH	Blister	24	516663
Alternative	MDNA660U2200PTEH-PC	MDNA660U2200PTEH	Blister	24	514482

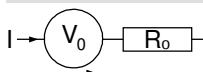
Temperature Sensor NTC

Symbol	Definition	Conditions	min.	typ.	max.	Unit
R_{25}	resistance	$T_{VJ} = 25^\circ$	4.85	5	5.15	k Ω
$B_{25/50}$	temperature coefficient			3375		K

Equivalent Circuits for Simulation

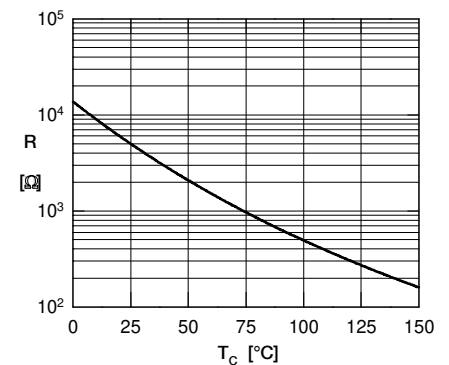
* on die level

$T_{VJ} = 150^\circ C$



Rectifier

$V_{0 \max}$	threshold voltage	0.77				V
$R_{0 \max}$	slope resistance *	0.57				m Ω



Typ. NTC resistance vs. temperature



Outlines E3-Pack

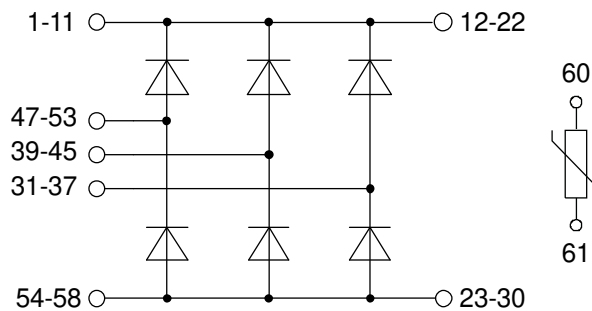


Bemerkung / Note:

- Nichttolerierete Maße nach / Measure without tolerances according DIN ISO 2768-T1-m
- PCB-Lochmuster / PCB hole pattern: **see pin position**
- Toleranz Pin-Position und PCB-Lochmuster / Tolerance of pin position and PCB hole pattern: $\oplus 0.1$
- Bohrlochdurchmesser / Diameter of drill: **Ø 2.35 mm**
- Endlochdurchmesser / Diameter of plated holes: **Ø 2.14 - 2.29 mm** (Cu thickness in via typ. 50 µm)
- Beschichtung / Plating: **chem. Sn max. 15 µm**
- Einpresskraft / Insert Force: per terminal with a typ. insert speed of 7 mm/s: **typ. 90 N**
- Weitere Angaben / Further information: www.ixys.com **Application note IXAN0077**
- Montageanleitung / Mounting instruction: www.ixys.com **Application note IXAN0024**

Detail A: PCB-Montage / Mounting on PCB¹

- Empfohlene, selbstschneidende Schraube / Recommended, self-tapping screw: **EJOT PT®** (Größe / size: **K25**)¹
- Max. Schraubenlänge / Max. screw length: **PCB-Dicke / thickness + 6 mm** (max. Lochtiefe / hole depth)¹
- Empfohlenes Drehmoment / Recommended mounting torque: **1.5 Nm**



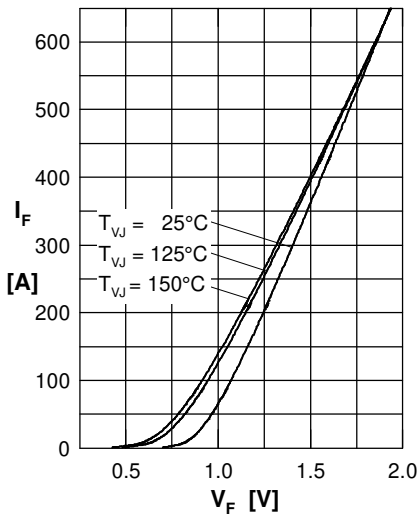
Rectifier


Fig. 1 Forward current versus voltage drop per diode

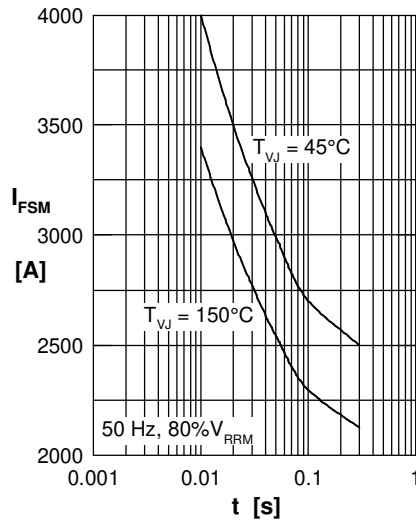


Fig. 2 Surge overload current vs. time per diode

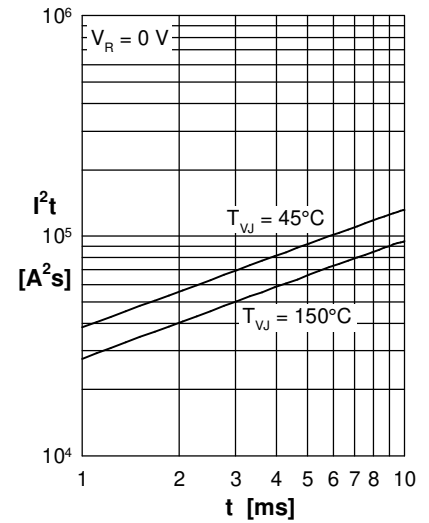
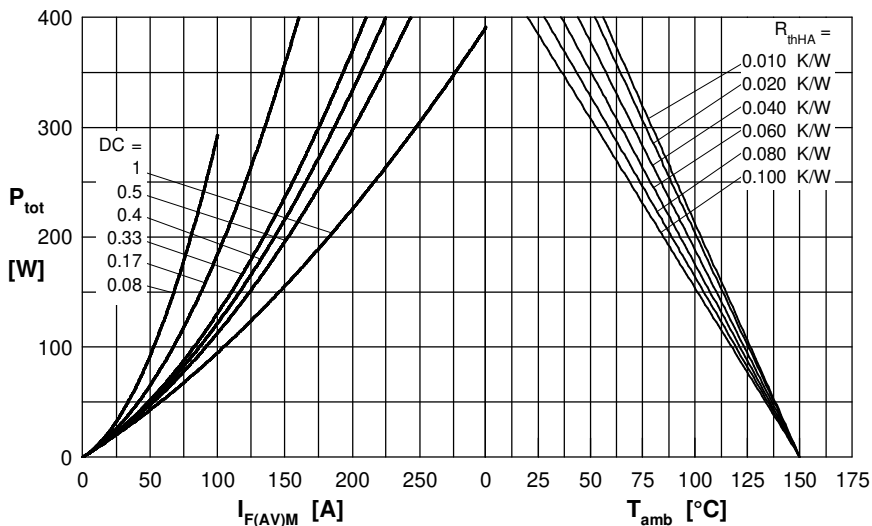

 Fig. 3 I^2t versus time per diode


Fig. 4 Power dissipation vs. forward current and ambient temperature per diode

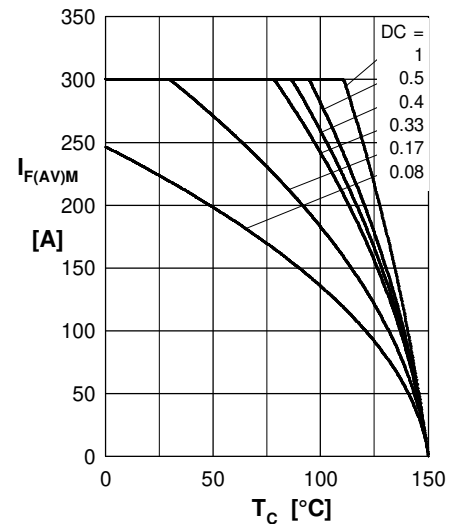


Fig. 5 Max. forward current vs. case temperature per diode

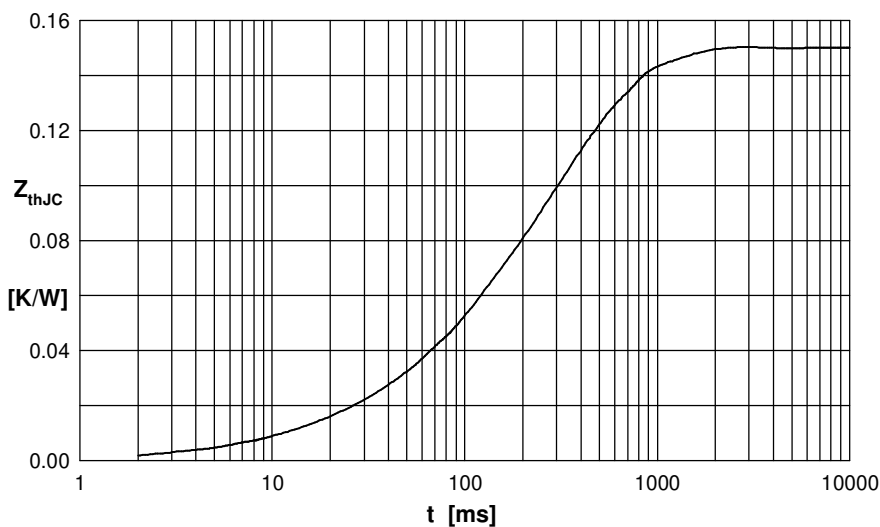


Fig. 6 Transient thermal impedance junction to case vs. time per diode

 Constants for Z_{thjC} calculation:

i	R_{thi} (K/W)	t_i (s)
1	0.006	0.015
2	0.017	0.080
3	0.039	0.220
4	0.088	0.380



Компания «ЭлектроПласт» предлагает заключение долгосрочных отношений при поставках импортных электронных компонентов на взаимовыгодных условиях!

Наши преимущества:

- Оперативные поставки широкого спектра электронных компонентов отечественного и импортного производства напрямую от производителей и с крупнейших мировых складов;
- Поставка более 17-ти миллионов наименований электронных компонентов;
- Поставка сложных, дефицитных, либо снятых с производства позиций;
- Оперативные сроки поставки под заказ (от 5 рабочих дней);
- Экспресс доставка в любую точку России;
- Техническая поддержка проекта, помощь в подборе аналогов, поставка прототипов;
- Система менеджмента качества сертифицирована по Международному стандарту ISO 9001;
- Лицензия ФСБ на осуществление работ с использованием сведений, составляющих государственную тайну;
- Поставка специализированных компонентов (Xilinx, Altera, Analog Devices, Intersil, Interpoint, Microsemi, Aeroflex, Peregrine, Syfer, Eurofarad, Texas Instrument, Miteq, Cobham, E2V, MA-COM, Hittite, Mini-Circuits, General Dynamics и др.);

Помимо этого, одним из направлений компании «ЭлектроПласт» является направление «Источники питания». Мы предлагаем Вам помощь Конструкторского отдела:

- Подбор оптимального решения, техническое обоснование при выборе компонента;
- Подбор аналогов;
- Консультации по применению компонента;
- Поставка образцов и прототипов;
- Техническая поддержка проекта;
- Защита от снятия компонента с производства.



Как с нами связаться

Телефон: 8 (812) 309 58 32 (многоканальный)

Факс: 8 (812) 320-02-42

Электронная почта: org@eplast1.ru

Адрес: 198099, г. Санкт-Петербург, ул. Калинина, дом 2, корпус 4, литера А.