

FOR BOARD-TO-BOARD AND BOARD-TO-FPC CONNECTION

NARROW PITCH (0.4mm) CONNECTORS P4S SERIES



Compliance with RoHS Directive

This will contribute to weight and size savings in devices. (Comparison made with 20 contacts.)

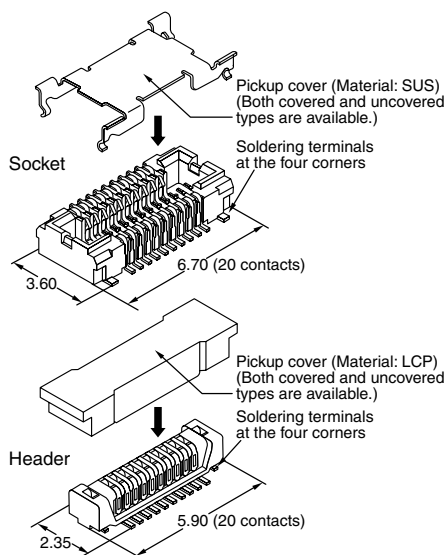

2. Strong resistance to adverse environments! Utilizes "TOUGH CONTACT" construction for high contact reliability.
(See Page 6 for details of the structure)

Note: If extra resistance to shock caused by dropping is required, we recommend using our previous P4 Series.

3. Greater flexibility in connector placement.
Pattern wiring to the connector bottom is possible because the undersurface of the

connector is constructed with a molded covering.



4. Automatic mounting inspection is facilitated by the gull-wing terminal shape which makes mounting verification easy.

5. Connectors for inspection available
Connectors are available that are ideal for inspection in module unit inspection and device assembly processes.

APPLICATIONS

Compact portable devices "Cellular phones, DVC, Digital cameras, etc"



FEATURES

1. Space saving
Compared to the currently sold P4 series with soldering terminal, 38% space is saved in the socket and 34% space saved in the header.

ORDERING INFORMATION

AXT **4**

3: Narrow Pitch Connector P4S (0.4 mm pitch) Socket	
4: Narrow Pitch Connector P4S (0.4 mm pitch) Header	
Number of contacts (2 digits)	
Mated height	
<Socket>	
1: For mated height 1.5 mm and 2.0 mm	
2: For mated height 2.5 mm and 3.0 mm	
<Header>	
1: For mated height 1.5 mm and 2.5 mm	
2: For mated height 2.0 mm	
3: For mated height 3.0 mm	
Functions	
<Socket/Header>	
5: With pickup cover, with positioning bosses	
6: With pickup cover, without positioning bosses	
Surface treatment (Contact portion / Terminal portion)	
<Socket> 4: Ni plating on base, Au plating on surface (for Ni barrier available)	
<Header> 4: Ni plating on base, Au plating on surface	

AXT3, 4

PRODUCT TYPES

Mated height	Number of contacts	Part number		Packing	
		Socket	Header	Inner carton	Outer carton
1.5mm	10	AXT310124	AXT410124	3,000 pieces	6,000 pieces
	16	AXT316124	AXT416124		
	20	AXT320124	AXT420124		
	22	AXT322124	AXT422124		
	24	AXT324124	AXT424124		
	26	AXT326124	AXT426124		
	28	AXT328124	AXT428124		
	30	AXT330124	AXT430124		
	32	AXT332124	AXT432124		
	34	AXT334124	AXT434124		
	36	AXT336124	AXT436124		
	38	AXT338124	AXT438124		
	40	AXT340124	AXT440124		
	44	AXT344124	AXT444124		
	46	AXT346124	AXT446124		
	50	AXT350124	AXT450124		
	54	AXT354124	AXT454124		
	56	AXT356124	AXT456124		
	60	AXT360124	AXT460124		
	2.0mm	40	AXT340124		
100		AXT300124	AXT400224		
2.5mm	20	AXT320224	AXT420124	3,000 pieces	6,000 pieces
	30	AXT330224	AXT430124		
	56	AXT356224	AXT456124		
	60	AXT360224	AXT460124		
	80	AXT380224	AXT480124		
3.0mm	100	AXT300224	AXT400124	3,000 pieces	6,000 pieces
	20	AXT320224	AXT420324		
	30	AXT330224	AXT430324		
	42	AXT342224	AXT442324		
	56	AXT356224	AXT456324		
	60	AXT360224	AXT460324		
	80	AXT380224	AXT480324		
100	AXT300224	AXT400324			
	120	AXT3A2224	AXT4A2324		

Notes: 1. Regarding ordering units; During production: Please make orders in 1-reel units.

Samples for mounting confirmation: Available in units of 50 pieces. Please consult us. (See "Regarding sample orders to confirm proper mounting" on page 19.)

Samples: Small lot orders are possible. Please consult us.

2. If you require the pickup cover, change the eighth digit of the part number from "2" to "6" in your order. Note that the pickup cover is not available for some types depending on the number of contacts. Check the latest product specifications.
3. The above part numbers are for connectors without positioning bosses, which are standard. When ordering connectors with positioning bosses, please contact our sales office.
4. Connectors of different mated height and different number of contacts are available on-demand production only. Please contact us for more details.

SPECIFICATIONS

1. Characteristics

Item		Specifications	Conditions
Electrical characteristics	Rated current	0.3A/contact (Max. 5 A at total contacts)	—
	Rated voltage	60V AC/DC	—
	Breakdown voltage	150V AC for 1 min.	Rated voltage is applied for one minute and check for short circuit or damage with a detection current of 1mA.
	Insulation resistance	Min. 1,000MΩ (initial)	Using 250V DC megger (applied for 1 min.)
	Contact resistance	Max. 90mΩ	Based on the contact resistance measurement method specified by JIS C 5402.
Environmental characteristics	Ambient temperature	-55°C to +85°C	No freezing at low temperatures
	Soldering heat resistance	Max. peak temperature of 260°C (on the surface of the PC board around the connector terminals)	Infrared reflow soldering
		300°C within 5 sec. or 350°C within 3 sec.	Soldering iron
	Storage temperature	-55°C to +85°C (product only) -40°C to +50°C (emboss packing)	No freezing at low temperatures
	Thermal shock resistance (header and socket mated)	5 cycles, insulation resistance min. 100MΩ, contact resistance max. 90mΩ	Sequence 1. -55 ₋₃ °C, 30 minutes 2. ~, Max. 5 minutes 3. 85 _{±3} °C, 30 minutes 4. ~, Max. 5 minutes
	Humidity resistance (header and socket mated)	120 hours, insulation resistance min. 100MΩ, contact resistance max. 90mΩ	Temperature 40±2°C, humidity 90 to 95% R.H.
	Saltwater spray resistance (header and socket mated)	24 hours, insulation resistance min. 100MΩ, contact resistance max. 90mΩ	Temperature 35±2°C, saltwater concentration 5±1%
H ₂ S resistance (header and socket mated)	48 hours, contact resistance max. 90mΩ	Temperature 40±2°C, gas concentration 3±1 ppm, humidity 75 to 80% R.H.	
Lifetime characteristics	Insertion and removal life	50 times	Repeated insertion and removal speed of max. 200 times/hours

2. Material and surface treatment

Part name	Material	Surface treatment
Molded portion	LCP resin (UL94V-0)	—
Contact and Post	Copper alloy	Contact portion: Ni plating on base, Au plating on surface Terminal portion: Ni plating on base, Au plating on surface (Except for front edge of terminal) However, the area adjacent to the socket terminal is exposed to Ni on base. Soldering terminal portion; Socket: Ni plating on base, Pd + Au flash plating on surface (Expect for front edge of terminal) Header: Ni plating on base, Au plating on surface (Expect for front edge of terminal)

AXT3, 4

DIMENSIONS (Unit: mm) The CAD data of the products with a **CAD Data** mark can be downloaded from: <http://panasonic-electric-works.net/ac>

1. Socket (Mated height: 1.5mm, 2.0mm, 2.5mm, 3.0mm)

- Without pickup cover

CAD Data

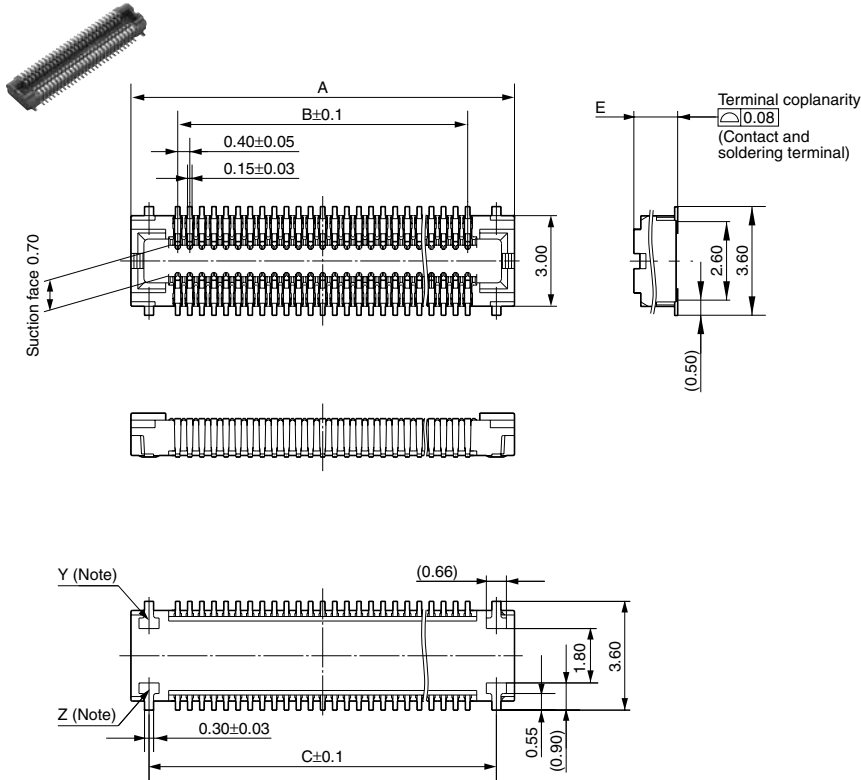

General tolerance: ± 0.2

Dimension table (mm)

Number of contacts/ dimension	A	B	C
10	4.7	1.6	3.5
16	5.9	2.8	4.7
20	6.7	3.6	5.5
22	7.1	4.0	5.9
24	7.5	4.4	6.3
26	7.9	4.8	6.7
28	8.3	5.2	7.1
30	8.7	5.6	7.5
32	9.1	6.0	7.9
34	9.5	6.4	8.3
36	9.9	6.8	8.7
38	10.3	7.2	9.1
40	10.7	7.6	9.5
42	11.1	8.0	9.9
44	11.5	8.4	10.3
46	11.9	8.8	10.7
50	12.7	9.6	11.5
54	13.5	10.4	12.3
56	13.9	10.8	12.7
60	14.7	11.6	13.5
70	16.7	13.6	15.5
80	18.7	15.6	17.5
90	20.7	17.6	19.5
100	22.7	19.6	21.5
120	26.7	23.6	25.5

Mated height/ dimension	E
1.5mm	1.45
2.0mm	1.45
2.5mm	2.45
3.0mm	2.45

- With pickup cover

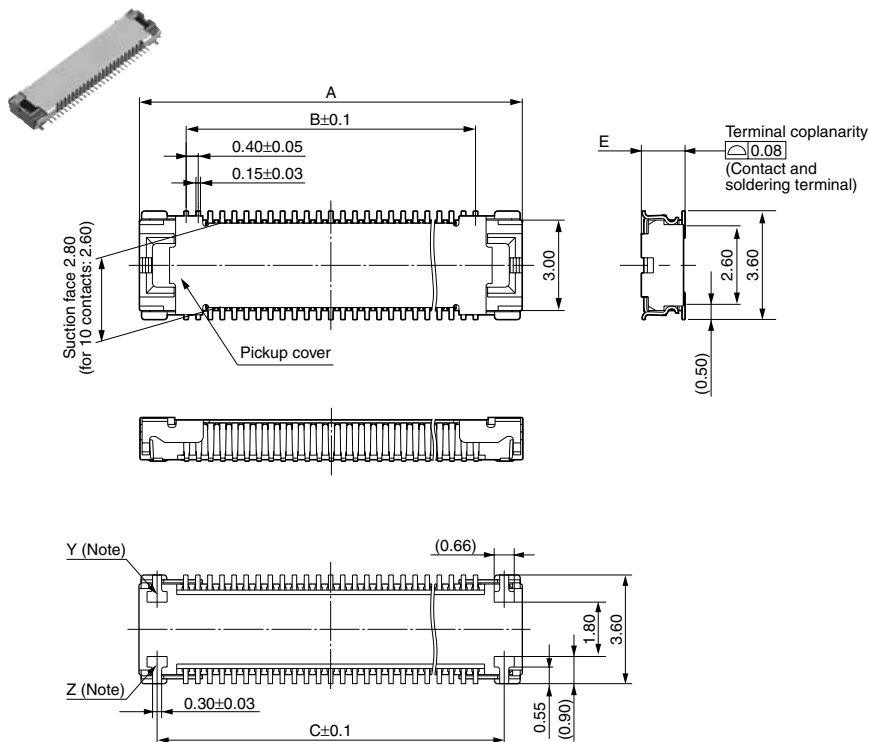

General tolerance: ± 0.2

Note: Since soldering terminals are built into the body, the Y and Z parts are connected electrically.

2. Header (Mated height: 1.5mm, 2.5mm)

- Without pickup cover

CAD Data

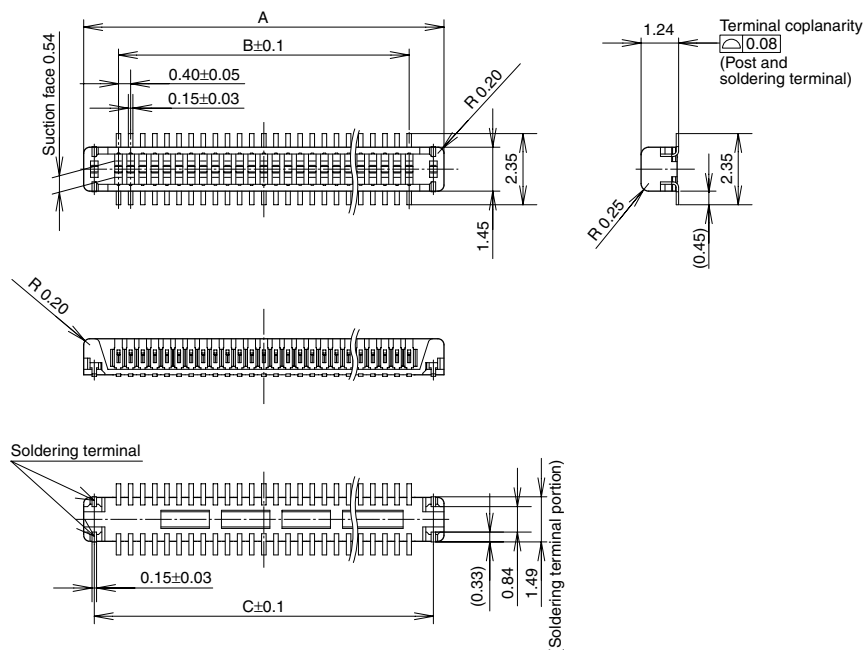

Dimension table (mm)

Number of contacts/ dimension	A	B	C	D
10	3.9	1.6	3.2	5.4
16	5.1	2.8	4.4	6.6
20	5.9	3.6	5.2	7.4
22	6.3	4.0	5.6	7.8
24	6.7	4.4	6.0	8.2
26	7.1	4.8	6.4	8.6
28	7.5	5.2	6.8	9.0
30	7.9	5.6	7.2	9.4
32	8.3	6.0	7.6	9.8
34	8.7	6.4	8.0	10.2
36	9.1	6.8	8.4	10.6
38	9.5	7.2	8.8	11.0
40	9.9	7.6	9.2	11.4
44	10.7	8.4	10.0	12.2
46	11.1	8.8	10.4	12.6
50	11.9	9.6	11.2	13.4
54	12.7	10.4	12.0	14.2
56	13.1	10.8	12.4	14.6
60	13.9	11.6	13.2	15.4
70	15.9	13.6	15.2	17.4
80	17.9	15.6	17.2	19.4
90	19.9	17.6	19.2	21.4
100	21.9	19.6	21.2	23.4

General tolerance: ±0.2

- With pickup cover

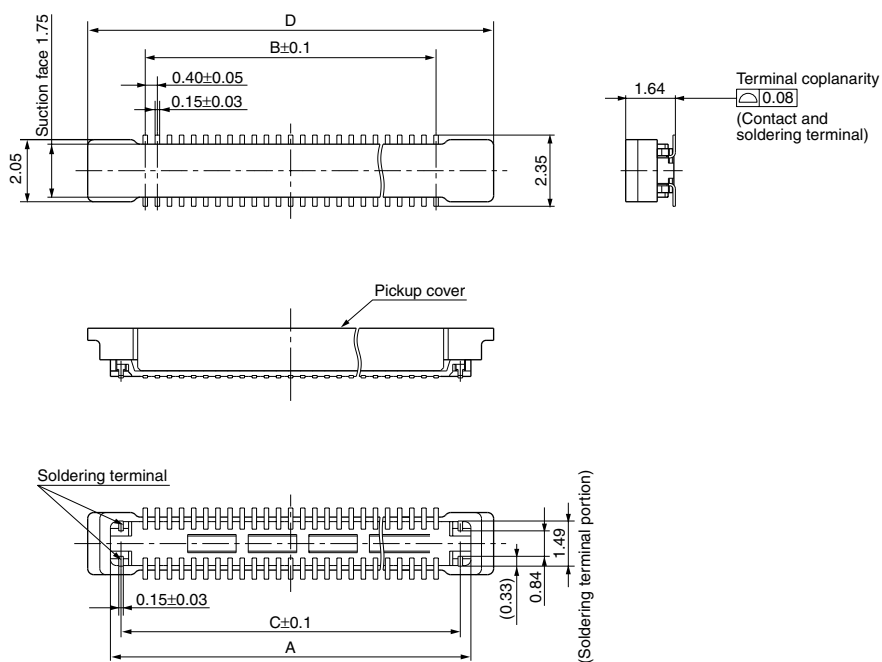

General tolerance: ±0.2

Note: The soldering terminal dimensions of headers with mating heights of 1.5mm/2.5mm and 2.0mm/3.0mm are different.

AXT3, 4

3. Header (Mated height: 2.0mm)

- Without pickup cover

CAD Data

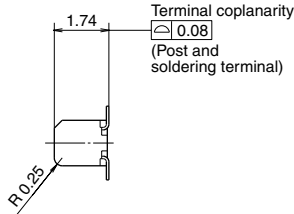
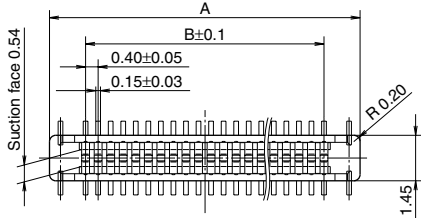

Dimension table (mm)

Number of contacts/ dimension	A	B	C	D
40	9.9	7.6	9.2	–
100	21.9	19.6	21.2	–

General tolerance: ±0.2

4. Header (Mated height: 3.0mm)

- Without pickup cover

CAD Data

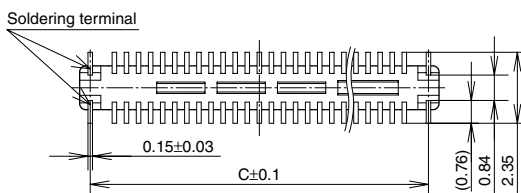
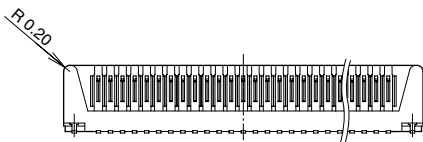
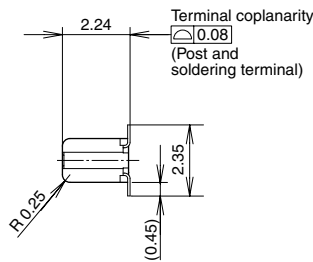
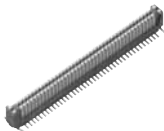

Dimension table (mm)

Number of contacts/ dimension	A	B	C	D
20	5.9	3.6	5.2	–
30	7.9	5.6	7.2	9.4
42	10.3	8.0	9.6	–
56	13.1	10.8	12.4	–
60	13.9	11.6	13.2	–
80	17.9	15.6	17.2	19.4
100	21.9	19.6	21.2	–
120	25.9	23.6	25.2	–

General tolerance: ±0.2

- With pickup cover

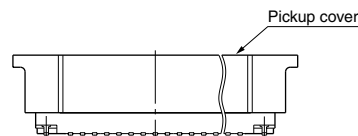

General tolerance: ±0.2

Note: The soldering terminal dimensions of headers with mating heights of 1.5mm/2.5mm and 2.0mm/3.0mm are different.

Socket and Header are mated



AXT3, 4

EMBOSSED TAPE DIMENSIONS (unit: mm, Common for respective contact type, socket and header)

• Tape dimensions (Conforming to JIS C 0806-1990.

• Plastic reel dimensions (Conforming to EIAJ ET-7200B)

However, some tapes have mounting hole pitches that do not comply with the standard.)

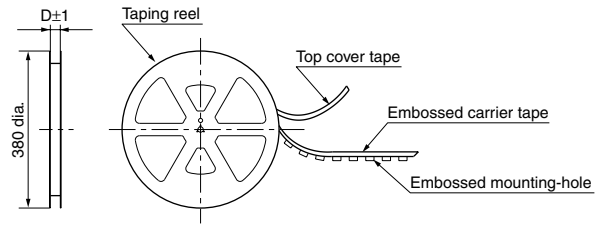

Dimension table (mm)

Mated height	Number of contacts		Type of taping	A	B	C	D	Quantity per reel
	Socket (with/without pickup cover) Header (without pickup cover)	Header (with pickup cover)						
Common for socket and header: 1.5mm, 2.0mm, 2.5mm and 3.0mm	Max. 24	Max. 24	Tape I	16.0	—	7.5	17.5	3,000
	26 to 70	26 to 64	Tape I	24.0	—	11.5	25.5	3,000
	72 to 100	66 to 90	Tape II	32.0	28.4	14.2	33.5	3,000
	120	100	Tape II	44.0	40.4	20.2	45.5	3,000

Connector orientation with respect to direction of progress of embossed tape

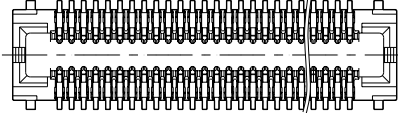
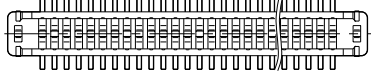
Direction of tape progress	Type	Common for P4S	
		Socket	Header
↓			

Note: There is no indication on this product regarding top-bottom or left-right orientation.



**CONNECTOR FOR INSPECTION
USAGE APPLICATIONS WITH
3,000 INSERTION AND
REMOVAL TIMES**

**NARROW PITCH CONNECTOR P4S
(0.4 mm PITCHES) FOR INSPECTION USAGE**



Socket

Header

Compliance with RoHS Directive

FEATURES

1. 3,000 insertion and removals (when as recommended)

From the 50 insertion and removals of standard type, up to 3,000 insertion and removals (with recommended insertion and removal) are possible for use in inspection.

Ideal for inspection of module units and inspection during the device assembly process

2. Same external dimensions and foot pattern as standard type.

Since shape is the same as standard type, inspection is possible without interfering with devices in the vicinity of standard connectors.

3. Improved mating

Insertion and removal have become easier due to a reduction in the mating retention force required by the simple locking structure and also in the amount of force needed for insertion and removal. (We cannot warrant anything regarding mating retention.)

☆: Available for sale

Product name	P4S for inspection
10	☆
16	☆
20	☆
22	☆
24	☆
26	☆
28	☆
30	☆
32	☆
34	☆
36	☆
38	☆
40	☆
44	☆
50	☆
54	☆
56	☆
60	☆
70	☆
80	☆
90	☆
100	☆

Number of contacts

Notes:

- You can use with each mated height in common.
- The pickup surface shape of the inspection sockets is different from that of the standard sockets. (For details, refer to the product specification diagram.)
- Please inquire about numbers of contacts other than those given above.
- Please inquire with us regarding delivery times.
- Please keep the minimum unit for ordering no less than 50 pieces per lot.
- Please inquire for further information.

PRODUCT TYPES

Specifications			Part No.	Specifications			Part No.
Socket	With pickup cover	Without positioning bosses	AXT3E**66	Header	With pickup cover	Without positioning bosses	AXT4E**66
	No pickup cover	Without positioning bosses	AXT3E**26		No pickup cover	Without positioning bosses	AXT4E**26

- Notes: 1. When placing an order, substitute the "*" (asterisk) in the above part number with the number of contacts for the required connector.
 2. The above part numbers are for connectors without positioning bosses, which are standard. When ordering connectors with positioning bosses, please contact our sales office.

AXT3, 4

NOTES

1. As shown below, excess force during insertion may result in damage to the connector or removal of the solder. Please be careful. Also, to prevent connector damage please confirm the correct position before mating connectors.



2. Keep the PC board warp no more than 0.03mm in relation to the overall length of the connector.

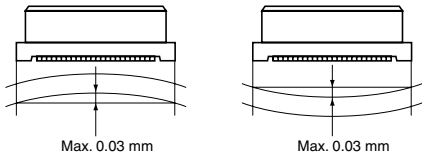

3. If extra resistance to shock caused by dropping is required, we recommend using our previous P4 Series.

4. PC Boards and Recommended Metal Mask Patterns

Connectors are mounted with high density, with a pitch interval of 0.4 to 0.5mm.

In order to reduce solder bridge and other issues make sure the proper levels of solder are used.

The figures to the right are recommended metal mask patterns.

Please use them as a reference.

Socket

(Mated height: 1.5mm, 2.0mm, 2.5mm and 3.0mm)

Recommended PC board pattern (TOP VIEW)



Recommended metal mask pattern

Metal mask thickness: Here, 150 μm
(Terminal portion opening area ratio: 48%)
(Metal portion opening area ratio: 100%)



Recommended metal mask pattern

Metal mask thickness: Here, 120 μm
(Terminal portion opening area ratio: 60%)
(Metal portion opening area ratio: 100%)

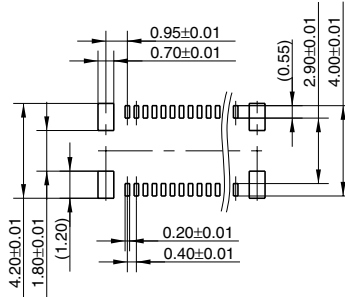

Header

(Mated height: 1.5mm and 2.5mm)

Recommended PC board pattern (TOP VIEW)



Recommended metal mask pattern

Metal mask thickness: Here, 150 μm
(Terminal portion opening area ratio: 49%)
(Metal portion opening area ratio: 100%)

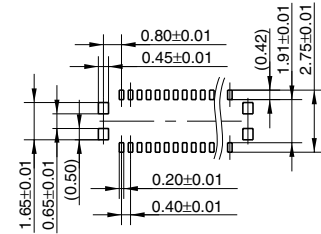

Recommended metal mask pattern

Metal mask thickness: Here, 120 μm
(Terminal portion opening area ratio: 60%)
(Metal portion opening area ratio: 100%)

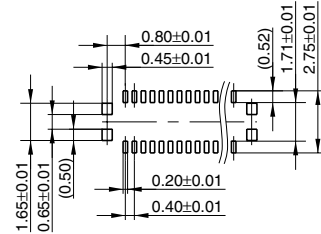

Header

(Mated height: 2.0mm, 3.0mm)

Recommended PC board pattern (TOP VIEW)

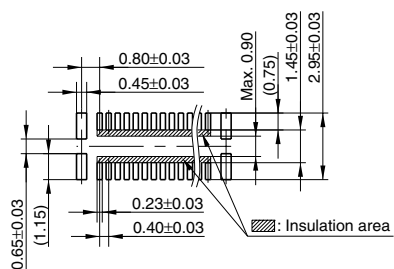

For other details, please verify with the product specification sheets.

Recommended metal mask pattern

Metal mask thickness: Here, 150 μm

(Terminal portion opening area ratio: 49%)

(Metal portion opening area ratio: 100%)

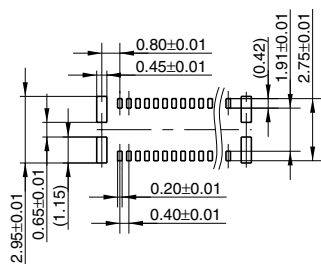

Recommended metal mask pattern

Metal mask thickness: Here, 120 μm

(Terminal portion opening area ratio: 60%)

(Metal portion opening area ratio: 100%)

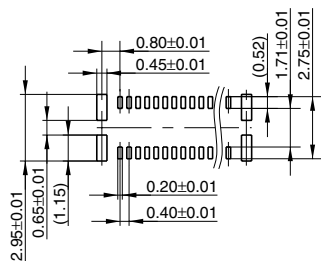

Note: The recommended PC board pattern diagrams and metal mask pattern diagrams for headers with mating heights of 1.5 mm/2.5 mm and 2.0 mm/3.0 mm are different.



Компания «ЭлектроПласт» предлагает заключение долгосрочных отношений при поставках импортных электронных компонентов на взаимовыгодных условиях!

Наши преимущества:

- Оперативные поставки широкого спектра электронных компонентов отечественного и импортного производства напрямую от производителей и с крупнейших мировых складов;
- Поставка более 17-ти миллионов наименований электронных компонентов;
- Поставка сложных, дефицитных, либо снятых с производства позиций;
- Оперативные сроки поставки под заказ (от 5 рабочих дней);
- Экспресс доставка в любую точку России;
- Техническая поддержка проекта, помощь в подборе аналогов, поставка прототипов;
- Система менеджмента качества сертифицирована по Международному стандарту ISO 9001;
- Лицензия ФСБ на осуществление работ с использованием сведений, составляющих государственную тайну;
- Поставка специализированных компонентов (Xilinx, Altera, Analog Devices, Intersil, Interpoint, Microsemi, Aeroflex, Peregrine, Syfer, Eurofarad, Texas Instrument, Miteq, Cobham, E2V, MA-COM, Hittite, Mini-Circuits, General Dynamics и др.);

Помимо этого, одним из направлений компании «ЭлектроПласт» является направление «Источники питания». Мы предлагаем Вам помощь Конструкторского отдела:

- Подбор оптимального решения, техническое обоснование при выборе компонента;
- Подбор аналогов;
- Консультации по применению компонента;
- Поставка образцов и прототипов;
- Техническая поддержка проекта;
- Защита от снятия компонента с производства.



Как с нами связаться

Телефон: 8 (812) 309 58 32 (многоканальный)

Факс: 8 (812) 320-02-42

Электронная почта: org@eplast1.ru

Адрес: 198099, г. Санкт-Петербург, ул. Калинина, дом 2, корпус 4, литера А.