

## FOR BOARD-TO-BOARD AND BOARD-TO-FPC CONNECTION

## NARROW PITCH (0.4mm) CONNECTORS P4S SERIES



Compliance with RoHS Directive

This will contribute to weight and size savings in devices. (Comparison made with 20 contacts.)

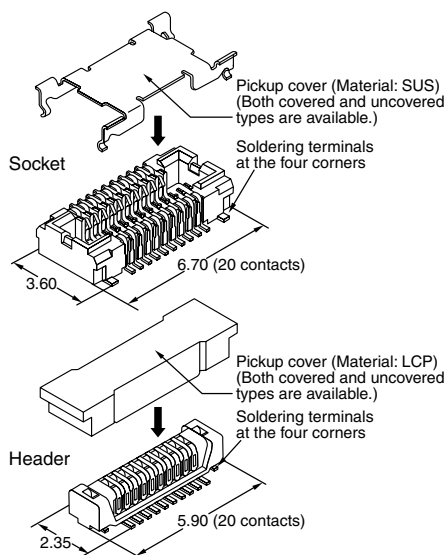

**2. Strong resistance to adverse environments! Utilizes "TOUGH CONTACT" construction for high contact reliability.**  
(See Page 6 for details of the structure)

Note: If extra resistance to shock caused by dropping is required, we recommend using our previous P4 Series.

**3. Greater flexibility in connector placement.**  
Pattern wiring to the connector bottom is possible because the undersurface of the

connector is constructed with a molded covering.

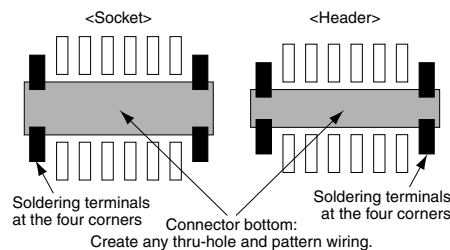

**4. Automatic mounting inspection is facilitated by the gull-wing terminal shape which makes mounting verification easy.**

**5. Connectors for inspection available**  
Connectors are available that are ideal for inspection in module unit inspection and device assembly processes.

### APPLICATIONS

Compact portable devices "Cellular phones, DVC, Digital cameras, etc"

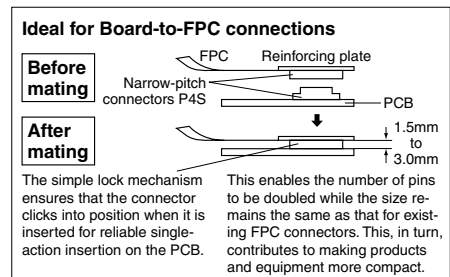

### FEATURES

**1. Space saving**  
Compared to the currently sold P4 series with soldering terminal, 38% space is saved in the socket and 34% space saved in the header.

### ORDERING INFORMATION

AXT      **4**

3: Narrow Pitch Connector P4S (0.4 mm pitch) Socket  
4: Narrow Pitch Connector P4S (0.4 mm pitch) Header

Number of contacts (2 digits)

Mated height

<Socket>

- 1: For mated height 1.5 mm and 2.0 mm
- 2: For mated height 2.5 mm and 3.0 mm

<Header>

- 1: For mated height 1.5 mm and 2.5 mm
- 2: For mated height 2.0 mm
- 3: For mated height 3.0 mm

Functions

<Socket/Header>

- 5: With pickup cover, with positioning bosses
- 6: With pickup cover, without positioning bosses

Surface treatment (Contact portion / Terminal portion)

- <Socket> 4: Ni plating on base, Au plating on surface (for Ni barrier available)
- <Header> 4: Ni plating on base, Au plating on surface

# AXT3, 4

## PRODUCT TYPES

| Mated height | Number of contacts | Part number |           | Packing      |              |
|--------------|--------------------|-------------|-----------|--------------|--------------|
|              |                    | Socket      | Header    | Inner carton | Outer carton |
| 1.5mm        | 10                 | AXT310124   | AXT410124 | 3,000 pieces | 6,000 pieces |
|              | 16                 | AXT316124   | AXT416124 |              |              |
|              | 20                 | AXT320124   | AXT420124 |              |              |
|              | 22                 | AXT322124   | AXT422124 |              |              |
|              | 24                 | AXT324124   | AXT424124 |              |              |
|              | 26                 | AXT326124   | AXT426124 |              |              |
|              | 28                 | AXT328124   | AXT428124 |              |              |
|              | 30                 | AXT330124   | AXT430124 |              |              |
|              | 32                 | AXT332124   | AXT432124 |              |              |
|              | 34                 | AXT334124   | AXT434124 |              |              |
|              | 36                 | AXT336124   | AXT436124 |              |              |
|              | 38                 | AXT338124   | AXT438124 |              |              |
|              | 40                 | AXT340124   | AXT440124 |              |              |
|              | 44                 | AXT344124   | AXT444124 |              |              |
|              | 46                 | AXT346124   | AXT446124 |              |              |
|              | 50                 | AXT350124   | AXT450124 |              |              |
|              | 54                 | AXT354124   | AXT454124 |              |              |
|              | 56                 | AXT356124   | AXT456124 |              |              |
|              | 60                 | AXT360124   | AXT460124 |              |              |
|              | 2.0mm              | 40          | AXT340124 |              |              |
| 100          |                    | AXT300124   | AXT400224 |              |              |
| 2.5mm        | 20                 | AXT320224   | AXT420124 | 3,000 pieces | 6,000 pieces |
|              | 30                 | AXT330224   | AXT430124 |              |              |
|              | 56                 | AXT356224   | AXT456124 |              |              |
|              | 60                 | AXT360224   | AXT460124 |              |              |
|              | 80                 | AXT380224   | AXT480124 |              |              |
| 3.0mm        | 100                | AXT300224   | AXT400124 | 3,000 pieces | 6,000 pieces |
|              | 20                 | AXT320224   | AXT420324 |              |              |
|              | 30                 | AXT330224   | AXT430324 |              |              |
|              | 42                 | AXT342224   | AXT442324 |              |              |
|              | 56                 | AXT356224   | AXT456324 |              |              |
|              | 60                 | AXT360224   | AXT460324 |              |              |
|              | 80                 | AXT380224   | AXT480324 |              |              |
| 100          | AXT300224          | AXT400324   |           |              |              |
|              | 120                | AXT3A2224   | AXT4A2324 |              |              |

Notes: 1. Regarding ordering units; During production: Please make orders in 1-reel units.

Samples for mounting confirmation: Available in units of 50 pieces. Please consult us. (See "Regarding sample orders to confirm proper mounting" on page 19.)

Samples: Small lot orders are possible. Please consult us.

2. If you require the pickup cover, change the eighth digit of the part number from "2" to "6" in your order. Note that the pickup cover is not available for some types depending on the number of contacts. Check the latest product specifications.
3. The above part numbers are for connectors without positioning bosses, which are standard. When ordering connectors with positioning bosses, please contact our sales office.
4. Connectors of different mated height and different number of contacts are available on-demand production only. Please contact us for more details.

# SPECIFICATIONS

## 1. Characteristics

| Item   |   | Specifications   | Conditions  |
|--|---|--|---|
| Electrical characteristics                               | Rated current   | 0.3A/contact<br>(Max. 5 A at total contacts)   | —   |
|  | Rated voltage   | 60V AC/DC  | —   |
|  | Breakdown voltage                                       | 150V AC for 1 min.   | Rated voltage is applied for one minute and check for short circuit or damage with a detection current of 1mA.                        |
|  | Insulation resistance                                   | Min. 1,000M $\Omega$ (initial)   | Using 250V DC megger<br>(applied for 1 min.)  |
|  | Contact resistance                                      | Max. 90m $\Omega$  | Based on the contact resistance measurement method specified by JIS C 5402.   |
| Environmental characteristics                            | Ambient temperature                                     | -55°C to +85°C   | No freezing at low temperatures   |
|  | Soldering heat resistance                               | Max. peak temperature of 260°C (on the surface of the PC board around the connector terminals)   | Infrared reflow soldering   |
|  |   | 300°C within 5 sec. or 350°C within 3 sec.   | Soldering iron  |
|  | Storage temperature                                     | -55°C to +85°C (product only)<br>-40°C to +50°C (emboss packing)                                 | No freezing at low temperatures   |
|  | Thermal shock resistance<br>(header and socket mated)   | 5 cycles,<br>insulation resistance min. 100M $\Omega$ ,<br>contact resistance max. 90m $\Omega$  | Sequence<br>1. -55 $\frac{3}{3}$ °C, 30 minutes<br>2. ~, Max. 5 minutes<br>3. 85 $\frac{3}{3}$ °C, 30 minutes<br>4. ~, Max. 5 minutes |
|  | Humidity resistance<br>(header and socket mated)        | 120 hours,<br>insulation resistance min. 100M $\Omega$ ,<br>contact resistance max. 90m $\Omega$ | Temperature 40 $\pm$ 2°C,<br>humidity 90 to 95% R.H.  |
|  | Saltwater spray resistance<br>(header and socket mated) | 24 hours,<br>insulation resistance min. 100M $\Omega$ ,<br>contact resistance max. 90m $\Omega$  | Temperature 35 $\pm$ 2°C,<br>saltwater concentration 5 $\pm$ 1%   |
| H <sub>2</sub> S resistance<br>(header and socket mated) | 48 hours,<br>contact resistance max. 90m $\Omega$       | Temperature 40 $\pm$ 2°C,<br>gas concentration 3 $\pm$ 1 ppm,<br>humidity 75 to 80% R.H.         |   |
| Lifetime characteristics                                 | Insertion and removal life                              | 50 times   | Repeated insertion and removal speed of max. 200 times/hours  |

## 2. Material and surface treatment

| Part name        | Material            | Surface treatment  |
|------------------|---------------------|--|
| Molded portion   | LCP resin (UL94V-0) | —  |
| Contact and Post | Copper alloy        | Contact portion: Ni plating on base, Au plating on surface<br>Terminal portion: Ni plating on base, Au plating on surface (Except for front edge of terminal)<br>However, the area adjacent to the socket terminal is exposed to Ni on base.<br>Soldering terminal portion;<br>Socket: Ni plating on base, Pd + Au flash plating on surface<br>(Expect for front edge of terminal)<br>Header: Ni plating on base, Au plating on surface<br>(Expect for front edge of terminal) |

# AXT3, 4

**DIMENSIONS** (Unit: mm) The CAD data of the products with a **CAD Data** mark can be downloaded from: <http://panasonic-electric-works.net/ac>

## 1. Socket (Mated height: 1.5mm, 2.0mm, 2.5mm, 3.0mm)

- Without pickup cover

**CAD Data**

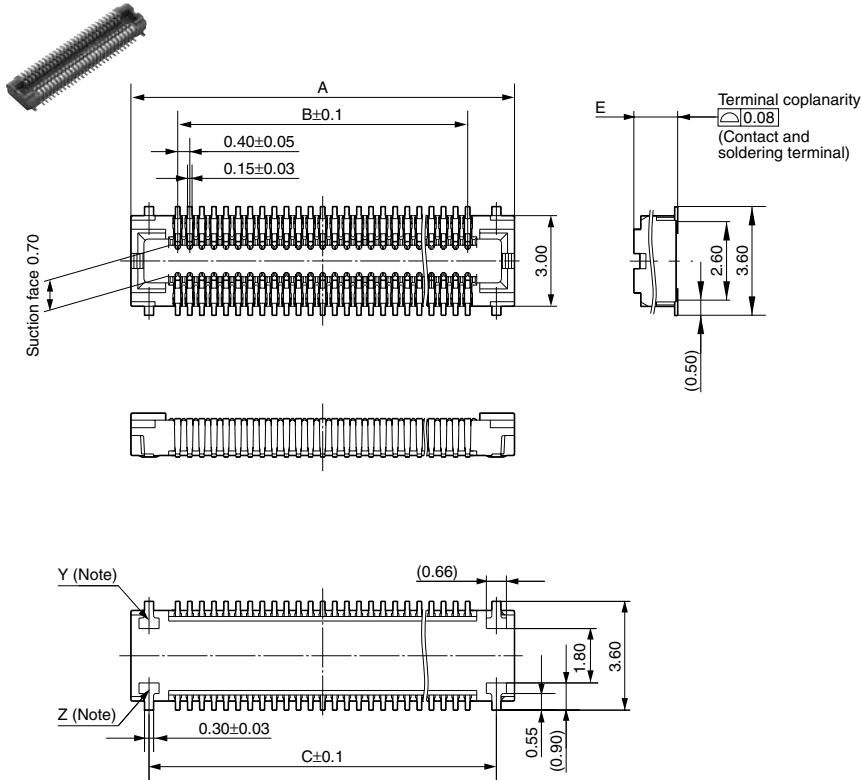

General tolerance:  $\pm 0.2$

Dimension table (mm)

| Number of contacts/<br>dimension | A    | B    | C    |
|----------------------------------|------|------|------|
| 10                               | 4.7  | 1.6  | 3.5  |
| 16                               | 5.9  | 2.8  | 4.7  |
| 20                               | 6.7  | 3.6  | 5.5  |
| 22                               | 7.1  | 4.0  | 5.9  |
| 24                               | 7.5  | 4.4  | 6.3  |
| 26                               | 7.9  | 4.8  | 6.7  |
| 28                               | 8.3  | 5.2  | 7.1  |
| 30                               | 8.7  | 5.6  | 7.5  |
| 32                               | 9.1  | 6.0  | 7.9  |
| 34                               | 9.5  | 6.4  | 8.3  |
| 36                               | 9.9  | 6.8  | 8.7  |
| 38                               | 10.3 | 7.2  | 9.1  |
| 40                               | 10.7 | 7.6  | 9.5  |
| 42                               | 11.1 | 8.0  | 9.9  |
| 44                               | 11.5 | 8.4  | 10.3 |
| 46                               | 11.9 | 8.8  | 10.7 |
| 50                               | 12.7 | 9.6  | 11.5 |
| 54                               | 13.5 | 10.4 | 12.3 |
| 56                               | 13.9 | 10.8 | 12.7 |
| 60                               | 14.7 | 11.6 | 13.5 |
| 70                               | 16.7 | 13.6 | 15.5 |
| 80                               | 18.7 | 15.6 | 17.5 |
| 90                               | 20.7 | 17.6 | 19.5 |
| 100                              | 22.7 | 19.6 | 21.5 |
| 120                              | 26.7 | 23.6 | 25.5 |

| Mated height/<br>dimension | E    |
|----------------------------|------|
| 1.5mm                      | 1.45 |
| 2.0mm                      | 1.45 |
| 2.5mm                      | 2.45 |
| 3.0mm                      | 2.45 |

- With pickup cover

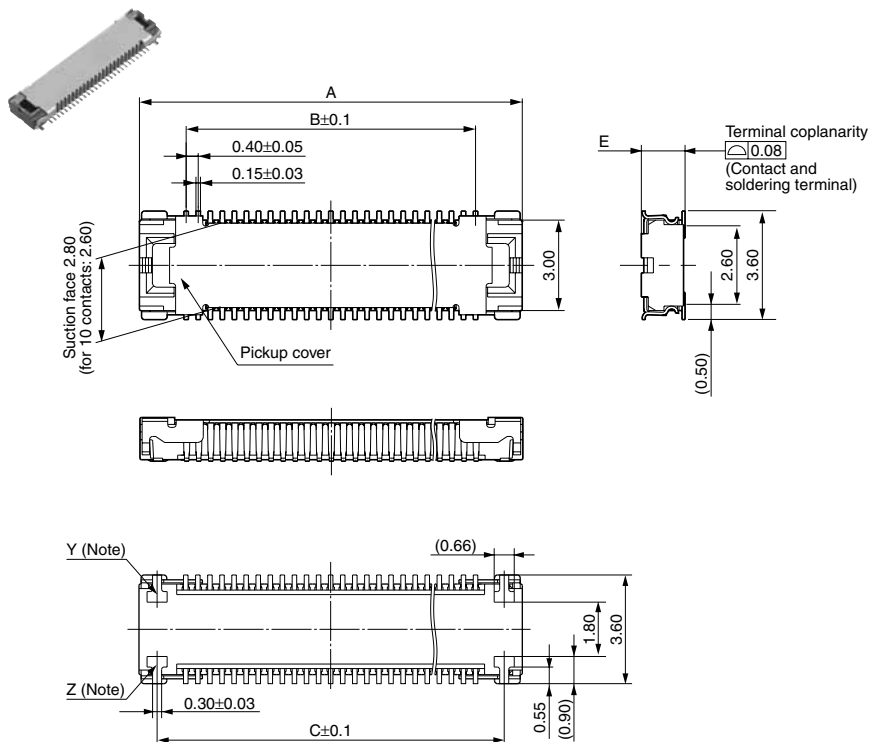

General tolerance:  $\pm 0.2$

Note: Since soldering terminals are built into the body, the Y and Z parts are connected electrically.

2. Header (Mated height: 1.5mm, 2.5mm)

- Without pickup cover

CAD Data

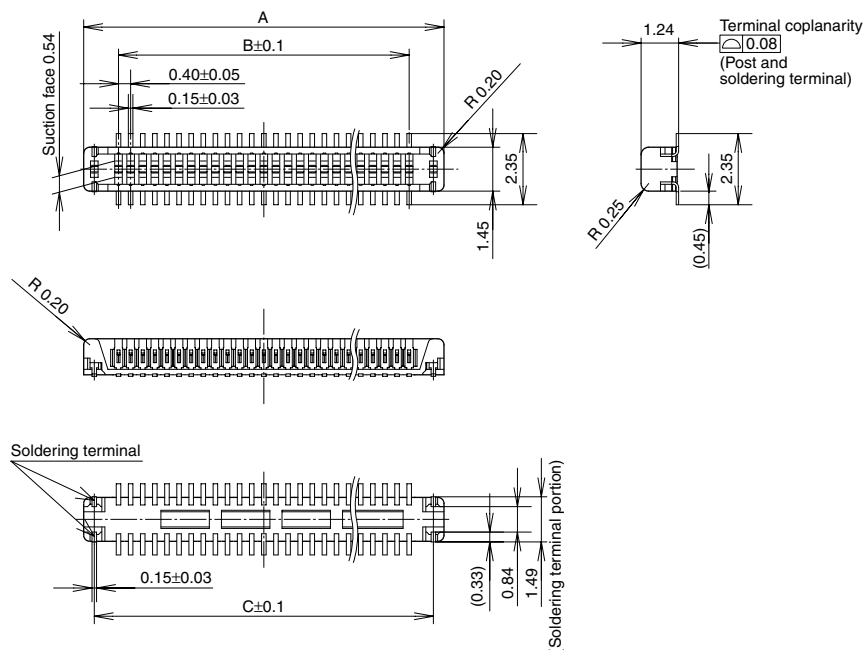

Dimension table (mm)

| Number of contacts/<br>dimension | A    | B    | C    | D    |
|----------------------------------|------|------|------|------|
| 10                               | 3.9  | 1.6  | 3.2  | 5.4  |
| 16                               | 5.1  | 2.8  | 4.4  | 6.6  |
| 20                               | 5.9  | 3.6  | 5.2  | 7.4  |
| 22                               | 6.3  | 4.0  | 5.6  | 7.8  |
| 24                               | 6.7  | 4.4  | 6.0  | 8.2  |
| 26                               | 7.1  | 4.8  | 6.4  | 8.6  |
| 28                               | 7.5  | 5.2  | 6.8  | 9.0  |
| 30                               | 7.9  | 5.6  | 7.2  | 9.4  |
| 32                               | 8.3  | 6.0  | 7.6  | 9.8  |
| 34                               | 8.7  | 6.4  | 8.0  | 10.2 |
| 36                               | 9.1  | 6.8  | 8.4  | 10.6 |
| 38                               | 9.5  | 7.2  | 8.8  | 11.0 |
| 40                               | 9.9  | 7.6  | 9.2  | 11.4 |
| 44                               | 10.7 | 8.4  | 10.0 | 12.2 |
| 46                               | 11.1 | 8.8  | 10.4 | 12.6 |
| 50                               | 11.9 | 9.6  | 11.2 | 13.4 |
| 54                               | 12.7 | 10.4 | 12.0 | 14.2 |
| 56                               | 13.1 | 10.8 | 12.4 | 14.6 |
| 60                               | 13.9 | 11.6 | 13.2 | 15.4 |
| 70                               | 15.9 | 13.6 | 15.2 | 17.4 |
| 80                               | 17.9 | 15.6 | 17.2 | 19.4 |
| 90                               | 19.9 | 17.6 | 19.2 | 21.4 |
| 100                              | 21.9 | 19.6 | 21.2 | 23.4 |

General tolerance: ±0.2

- With pickup cover

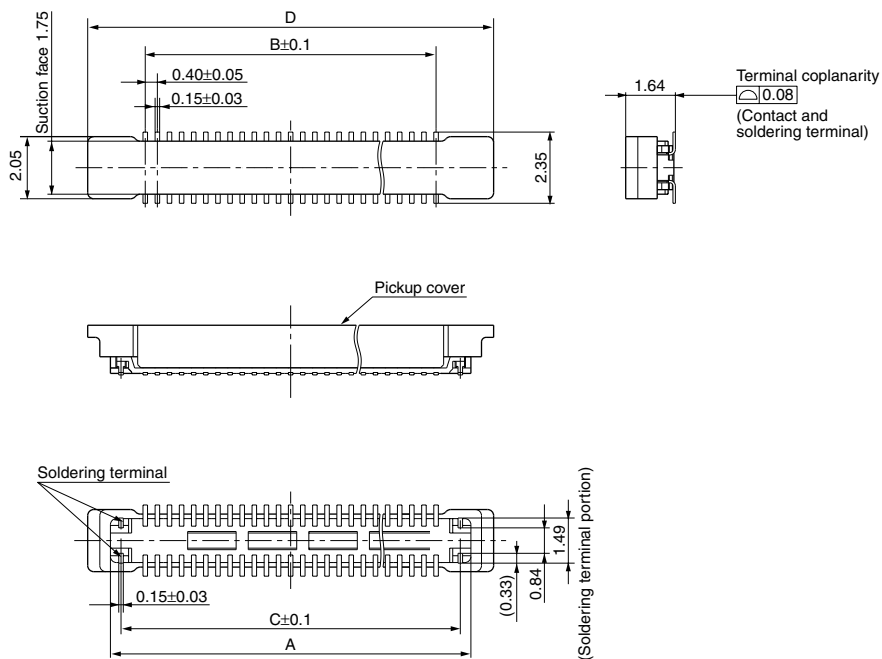

General tolerance: ±0.2

Note: The soldering terminal dimensions of headers with mating heights of 1.5mm/2.5mm and 2.0mm/3.0mm are different.

# AXT3, 4

## 3. Header (Mated height: 2.0mm)

- Without pickup cover

### CAD Data

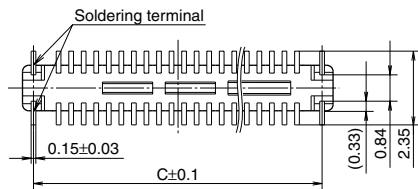
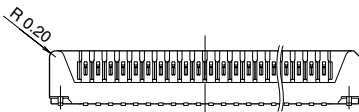
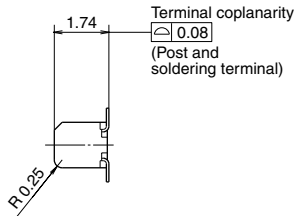
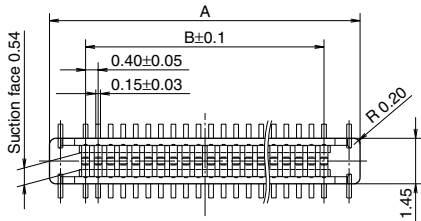

Dimension table (mm)

| Number of contacts/<br>dimension | A    | B    | C    | D |
|----------------------------------|------|------|------|---|
| 40                               | 9.9  | 7.6  | 9.2  | – |
| 100                              | 21.9 | 19.6 | 21.2 | – |

General tolerance: ±0.2

## 4. Header (Mated height: 3.0mm)

- Without pickup cover

### CAD Data

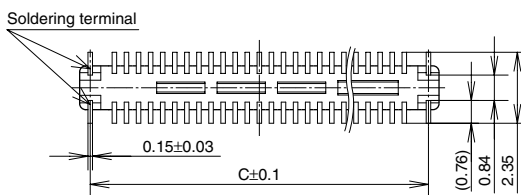
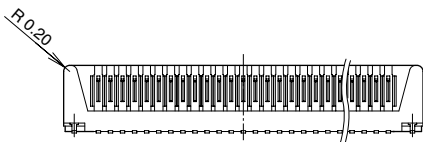
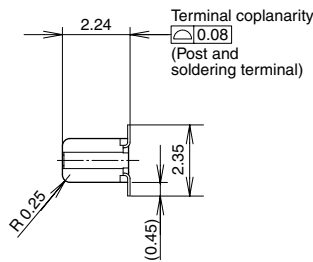
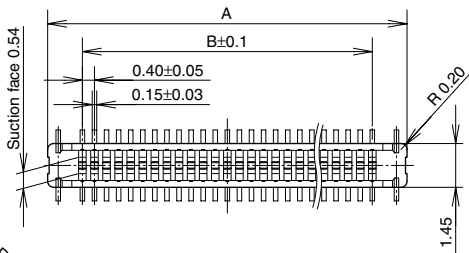
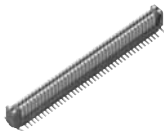

Dimension table (mm)

| Number of contacts/<br>dimension | A    | B    | C    | D    |
|----------------------------------|------|------|------|------|
| 20                               | 5.9  | 3.6  | 5.2  | –    |
| 30                               | 7.9  | 5.6  | 7.2  | 9.4  |
| 42                               | 10.3 | 8.0  | 9.6  | –    |
| 56                               | 13.1 | 10.8 | 12.4 | –    |
| 60                               | 13.9 | 11.6 | 13.2 | –    |
| 80                               | 17.9 | 15.6 | 17.2 | 19.4 |
| 100                              | 21.9 | 19.6 | 21.2 | –    |
| 120                              | 25.9 | 23.6 | 25.2 | –    |

General tolerance: ±0.2

- With pickup cover

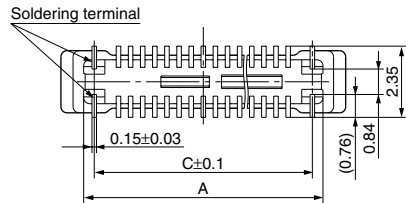
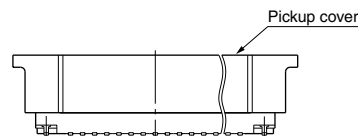
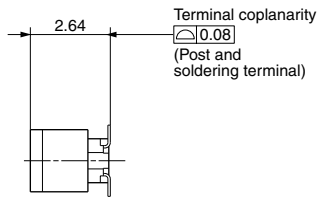
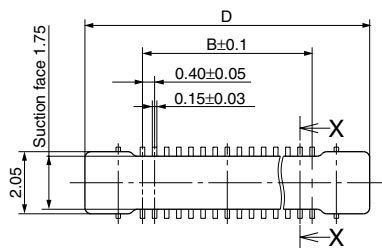

General tolerance: ±0.2

Note: The soldering terminal dimensions of headers with mating heights of 1.5mm/2.5mm and 2.0mm/3.0mm are different.

Socket and Header are mated

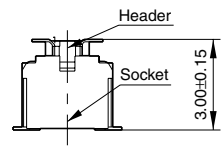
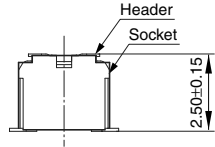
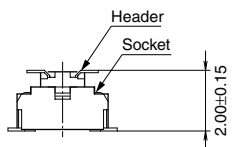
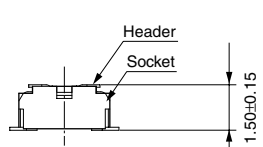

# AXT3, 4

## EMBOSSED TAPE DIMENSIONS (unit: mm, Common for respective contact type, socket and header)

• Tape dimensions (Conforming to JIS C 0806-1990.

• Plastic reel dimensions (Conforming to EIAJ ET-7200B)

However, some tapes have mounting hole pitches that do not comply with the standard.)

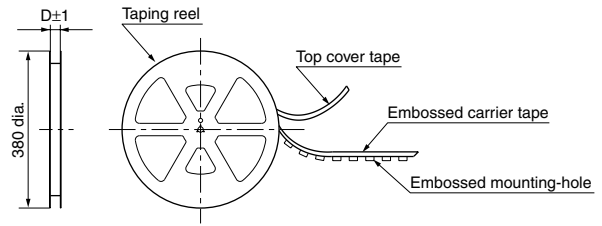
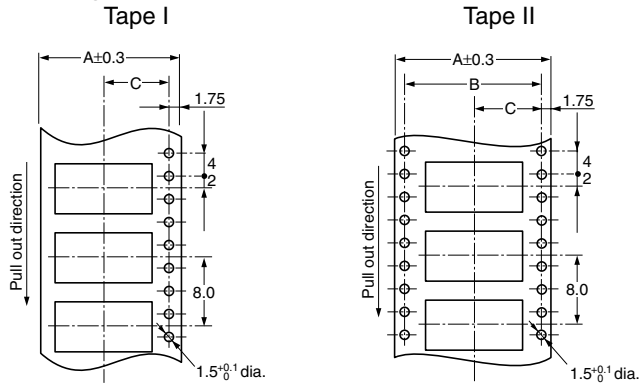

### Dimension table (mm)

| Mated height  | Number of contacts  |                               | Type of taping | A    | B    | C    | D    | Quantity per reel |
|---|---|-------------------------------|----------------|------|------|------|------|-------------------|
|   | Socket<br>(with/without pickup cover)<br>Header<br>(without pickup cover) | Header<br>(with pickup cover) |                |      |      |      |      |                   |
| Common for socket and header:<br>1.5mm, 2.0mm,<br>2.5mm and 3.0mm | Max. 24   | Max. 24                       | Tape I         | 16.0 | —    | 7.5  | 17.5 | 3,000             |
|   | 26 to 70  | 26 to 64                      | Tape I         | 24.0 | —    | 11.5 | 25.5 | 3,000             |
|   | 72 to 100   | 66 to 90                      | Tape II        | 32.0 | 28.4 | 14.2 | 33.5 | 3,000             |
|   | 120   | 100                           | Tape II        | 44.0 | 40.4 | 20.2 | 45.5 | 3,000             |

### Connector orientation with respect to direction of progress of embossed tape

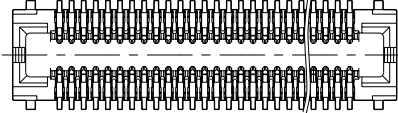
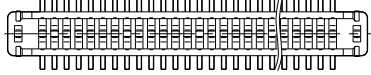
| Direction of tape progress | Type | Common for P4S  |   |
|----------------------------|------|---|---|
|                            |      | Socket  | Header  |
| ↓                          |      |  |  |

Note: There is no indication on this product regarding top-bottom or left-right orientation.





**CONNECTOR FOR INSPECTION  
USAGE APPLICATIONS WITH  
3,000 INSERTION AND  
REMOVAL TIMES**

**NARROW PITCH CONNECTOR P4S  
(0.4 mm PITCHES) FOR INSPECTION USAGE**



Socket

Header

**Compliance with RoHS Directive**

## FEATURES

### 1. 3,000 insertion and removals (when as recommended)

From the 50 insertion and removals of standard type, up to 3,000 insertion and removals (with recommended insertion and removal) are possible for use in inspection.

Ideal for inspection of module units and inspection during the device assembly process

### 2. Same external dimensions and foot pattern as standard type.

Since shape is the same as standard type, inspection is possible without interfering with devices in the vicinity of standard connectors.

### 3. Improved mating

Insertion and removal have become easier due to a reduction in the mating retention force required by the simple locking structure and also in the amount of force needed for insertion and removal. (We cannot warrant anything regarding mating retention.)

☆: Available for sale

| Product name | P4S for inspection |
|--------------|--------------------|
| 10           | ☆                  |
| 16           | ☆                  |
| 20           | ☆                  |
| 22           | ☆                  |
| 24           | ☆                  |
| 26           | ☆                  |
| 28           | ☆                  |
| 30           | ☆                  |
| 32           | ☆                  |
| 34           | ☆                  |
| 36           | ☆                  |
| 38           | ☆                  |
| 40           | ☆                  |
| 44           | ☆                  |
| 50           | ☆                  |
| 54           | ☆                  |
| 56           | ☆                  |
| 60           | ☆                  |
| 70           | ☆                  |
| 80           | ☆                  |
| 90           | ☆                  |
| 100          | ☆                  |

Number of contacts

Notes:

- You can use with each mated height in common.
- The pickup surface shape of the inspection sockets is different from that of the standard sockets. (For details, refer to the product specification diagram.)
- Please inquire about numbers of contacts other than those given above.
- Please inquire with us regarding delivery times.
- Please keep the minimum unit for ordering no less than 50 pieces per lot.
- Please inquire for further information.

## PRODUCT TYPES

| Specifications |                   |                            | Part No.  | Specifications |                   |                            | Part No.  |
|----------------|-------------------|----------------------------|-----------|----------------|-------------------|----------------------------|-----------|
| Socket         | With pickup cover | Without positioning bosses | AXT3E**66 | Header         | With pickup cover | Without positioning bosses | AXT4E**66 |
|                | No pickup cover   | Without positioning bosses | AXT3E**26 |                | No pickup cover   | Without positioning bosses | AXT4E**26 |

- Notes: 1. When placing an order, substitute the "\*" (asterisk) in the above part number with the number of contacts for the required connector.  
 2. The above part numbers are for connectors without positioning bosses, which are standard. When ordering connectors with positioning bosses, please contact our sales office.

# AXT3, 4

## NOTES

1. As shown below, excess force during insertion may result in damage to the connector or removal of the solder. Please be careful. Also, to prevent connector damage please confirm the correct position before mating connectors.

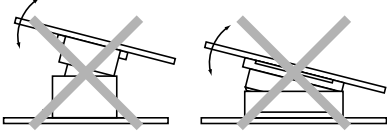

2. Keep the PC board warp no more than 0.03mm in relation to the overall length of the connector.

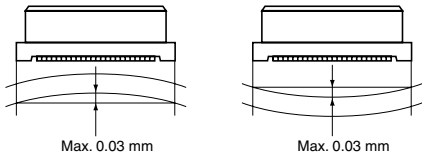

3. If extra resistance to shock caused by dropping is required, we recommend using our previous P4 Series.

### 4. PC Boards and Recommended Metal Mask Patterns

Connectors are mounted with high density, with a pitch interval of 0.4 to 0.5mm.

In order to reduce solder bridge and other issues make sure the proper levels of solder are used.

The figures to the right are recommended metal mask patterns.

Please use them as a reference.

### Socket

(Mated height: 1.5mm, 2.0mm, 2.5mm and 3.0mm)

Recommended PC board pattern (TOP VIEW)

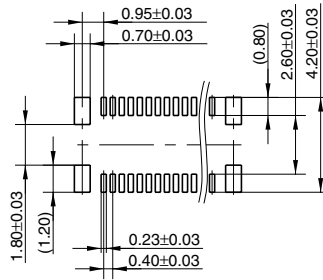

### Recommended metal mask pattern

Metal mask thickness: Here, 150 μm  
(Terminal portion opening area ratio: 48%)  
(Metal portion opening area ratio: 100%)

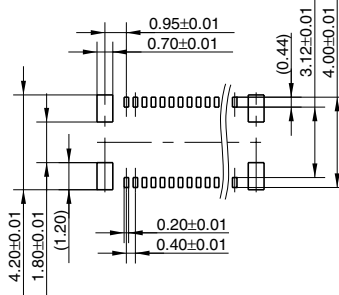

### Recommended metal mask pattern

Metal mask thickness: Here, 120 μm  
(Terminal portion opening area ratio: 60%)  
(Metal portion opening area ratio: 100%)

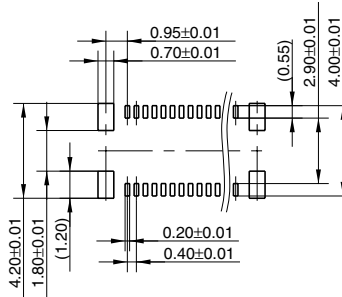

### Header

(Mated height: 1.5mm and 2.5mm)

Recommended PC board pattern (TOP VIEW)

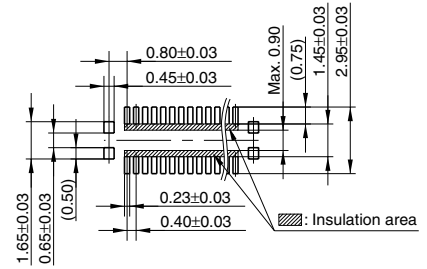

### Recommended metal mask pattern

Metal mask thickness: Here, 150 μm  
(Terminal portion opening area ratio: 49%)  
(Metal portion opening area ratio: 100%)

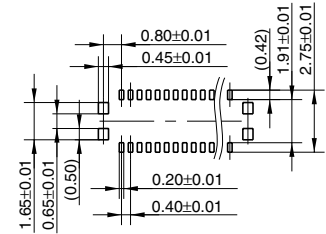

### Recommended metal mask pattern

Metal mask thickness: Here, 120 μm  
(Terminal portion opening area ratio: 60%)  
(Metal portion opening area ratio: 100%)

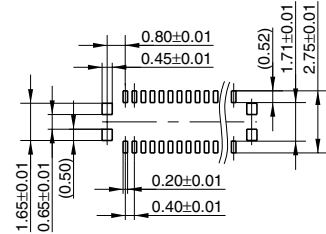

Header

(Mated height: 2.0mm, 3.0mm)

Recommended PC board pattern (TOP VIEW)

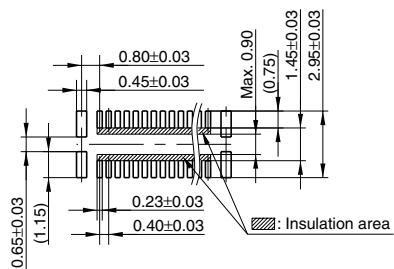

For other details, please verify with the product specification sheets.

Recommended metal mask pattern

Metal mask thickness: Here, 150 μm

(Terminal portion opening area ratio: 49%)

(Metal portion opening area ratio: 100%)

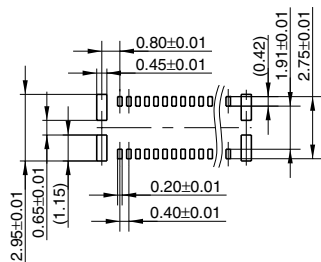

Recommended metal mask pattern

Metal mask thickness: Here, 120 μm

(Terminal portion opening area ratio: 60%)

(Metal portion opening area ratio: 100%)

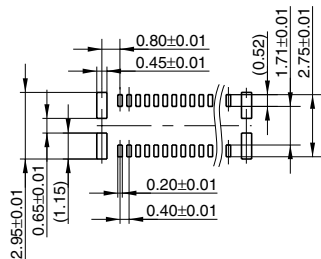

Note: The recommended PC board pattern diagrams and metal mask pattern diagrams for headers with mating heights of 1.5 mm/2.5 mm and 2.0 mm/3.0 mm are different.



Компания «ЭлектроПласт» предлагает заключение долгосрочных отношений при поставках импортных электронных компонентов на взаимовыгодных условиях!

Наши преимущества:

- Оперативные поставки широкого спектра электронных компонентов отечественного и импортного производства напрямую от производителей и с крупнейших мировых складов;
- Поставка более 17-ти миллионов наименований электронных компонентов;
- Поставка сложных, дефицитных, либо снятых с производства позиций;
- Оперативные сроки поставки под заказ (от 5 рабочих дней);
- Экспресс доставка в любую точку России;
- Техническая поддержка проекта, помощь в подборе аналогов, поставка прототипов;
- Система менеджмента качества сертифицирована по Международному стандарту ISO 9001;
- Лицензия ФСБ на осуществление работ с использованием сведений, составляющих государственную тайну;
- Поставка специализированных компонентов (Xilinx, Altera, Analog Devices, Intersil, Interpoint, Microsemi, Aeroflex, Peregrine, Syfer, Eurofarad, Texas Instrument, Miteq, Cobham, E2V, MA-COM, Hittite, Mini-Circuits, General Dynamics и др.);

Помимо этого, одним из направлений компании «ЭлектроПласт» является направление «Источники питания». Мы предлагаем Вам помощь Конструкторского отдела:

- Подбор оптимального решения, техническое обоснование при выборе компонента;
- Подбор аналогов;
- Консультации по применению компонента;
- Поставка образцов и прототипов;
- Техническая поддержка проекта;
- Защита от снятия компонента с производства.



#### Как с нами связаться

**Телефон:** 8 (812) 309 58 32 (многоканальный)

**Факс:** 8 (812) 320-02-42

**Электронная почта:** [org@eplast1.ru](mailto:org@eplast1.ru)

**Адрес:** 198099, г. Санкт-Петербург, ул. Калинина, дом 2, корпус 4, литера А.