

## N-Channel 40-V (D-S) MOSFET with Sensing Diode

**PRODUCT SUMMARY**

$V_{(BR)DSS}$ (V)	$r_{DS(on)}$ ( $\Omega$ )	$I_D$ (A)
40	0.0054 at $V_{GS} = 10$ V	60 <sup>a</sup>

**FEATURES**

- TrenchFET<sup>®</sup> Power MOSFETS Plus Temperature Sensing Diode
- 175 °C Junction Temperature
- Low Thermal Resistance Package

**RoHS\***  
COMPLIANT

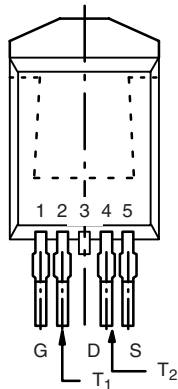
**D<sup>2</sup>PAK-5**

Ordering Information: SUM60N04-05T-E3 (Lead (Pb)-free)

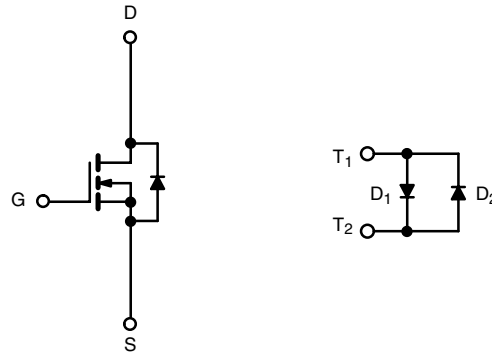

N-Channel MOSFET

**ABSOLUTE MAXIMUM RATINGS**  $T_C = 25$  °C, unless otherwise noted

Parameter	Symbol	Limit	Unit
Drain-Source Voltage	$V_{DS}$	40	V
Gate-Source Voltage	$V_{GS}$	$\pm 20$	
Continuous Drain Current ( $T_J = 175$ °C) <sup>d</sup>	$I_D$	$T_C = 25$ °C	60 <sup>a</sup>
		$T_C = 100$ °C	60 <sup>a</sup>
Pulsed Drain Current	$I_{DM}$	250	A
Continuous Diode Current (Diode Conduction) <sup>d</sup>	$I_S$	60 <sup>a</sup>	
Avalanche Current	$I_{AS}$	60 <sup>a</sup>	
Repetitive Avalanche Energy <sup>b</sup>	$E_{AS}$	180	mJ
Maximum Power Dissipation <sup>a</sup>	$P_D$	$T_C = 25$ °C	200 <sup>c</sup>
		$T_A = 25$ °C	3.75 <sup>d</sup>
Operating Junction and Storage Temperature Range	$T_J, T_{stg}$	- 55 to 175	°C

**THERMAL RESISTANCE RATINGS**

Parameter	Symbol	Limit	Unit
Junction-to-Ambient <sup>d</sup>	$R_{thJA}$	40	°C/W
Junction-to-Case	$R_{thJC}$	0.75	

Notes:

- Package limited.
- Duty cycle  $\leq 1\%$ .
- See SOA curve for voltage derating.
- When mounted on 1" square PCB (FR-4 material).

\* Pb containing terminations are not RoHS compliant, exemptions may apply.

<b>MOSFET SPECIFICATIONS</b> $T_J = 25\text{ }^\circ\text{C}$ , unless otherwise noted						
Parameter	Symbol	Test Conditions	Min.	Typ.	Max.	Unit
<b>Static</b>						
Drain-Source Breakdown Voltage	$V_{(BR)DSS}$	$V_{GS} = 0\text{ V}, I_D = 250\text{ }\mu\text{A}$	40			V
Gate-Threshold Voltage	$V_{GS(th)}$	$V_{DS} = V_{GS}, I_{DS} = 250\text{ }\mu\text{A}$	2.5		4.5	
Gate-Body Leakage	$I_{GSS}$	$V_{DS} = 0\text{ V}, V_{GS} = \pm 20\text{ V}$			$\pm 100$	nA
Zero Gate Voltage Drain Current	$I_{DSS}$	$V_{DS} = 40\text{ V}, V_{GS} = 0\text{ V}$			1	$\mu\text{A}$
		$V_{DS} = 40\text{ V}, V_{GS} = 0\text{ V}, T_J = 125\text{ }^\circ\text{C}$			50	
		$V_{DS} = 40\text{ V}, V_{GS} = 0\text{ V}, T_J = 175\text{ }^\circ\text{C}$			500	
On-State Drain Current <sup>a</sup>	$I_{D(on)}$	$V_{DS} = 5\text{ V}, V_{GS} = 10\text{ V}$	120			A
Drain-Source On-State Resistance <sup>a</sup>	$r_{DS(on)}$	$V_{GS} = 10\text{ V}, I_D = 25\text{ A}$		0.0043	0.0054	$\Omega$
		$V_{GS} = 10\text{ V}, I_D = 25\text{ A}, T_J = 125\text{ }^\circ\text{C}$			0.0088	
		$V_{GS} = 10\text{ V}, I_D = 25\text{ A}, T_J = 175\text{ }^\circ\text{C}$			0.011	
Sense Diode Forward Voltage	$V_{FD1}$	$I_F = 50\text{ }\mu\text{A}$	675		825	mV
	$V_{FD2}$	$I_F = 25\text{ }\mu\text{A}$	600		750	
Sense Diode Forward Voltage Increase	$\Delta V_F$	From $I_F = 25\text{ }\mu\text{A}$ to $I_F = 50\text{ }\mu\text{A}$	50		100	
Forward Transconductance <sup>a</sup>	$g_{fs}$	$V_{DS} = 15\text{ V}, I_D = 20\text{ A}$		35		S
<b>Dynamic<sup>b</sup></b>						
Input Capacitance	$C_{iss}$	$V_{GS} = 0\text{ V}, V_{DS} = 25\text{ V}, f = 1\text{ MHz}$		6400		$\mu\text{F}$
Output Capacitance	$C_{oss}$			1100		
Reverse Transfer Capacitance	$C_{rss}$			630		
Gate Resistance	$R_g$	$f = 1\text{ MHz}$		2.2		$\Omega$
Total Gate Charge <sup>c</sup>	$Q_g$	$V_{DS} = 20\text{ V}, V_{GS} = 10\text{ V}, I_D = 25\text{ A}$		115	150	nC
Gate-Source Charge <sup>c</sup>	$Q_{gs}$			35		
Gate-Drain Charge <sup>c</sup>	$Q_{gd}$			35		
Turn-On Delay Time <sup>c</sup>	$t_{d(on)}$	$V_{DD} = 20\text{ V}, R_L = 0.8\text{ }\Omega$ $I_D \cong 25\text{ A}, V_{GEN} = 10\text{ V}, R_G = 2.5\text{ }\Omega$		15	20	ns
Rise Time <sup>c</sup>	$t_r$			150	210	
Turn-Off Delay Time <sup>c</sup>	$t_{d(off)}$			60	85	
Fall Time <sup>c</sup>	$t_f$			80	110	
<b>Source-Drain Diode Ratings and Characteristics</b> $T_C = 25\text{ }^\circ\text{C}$ <sup>b</sup>						
Continuous Current	$I_S$				60	A
Pulsed Current	$I_{SM}$				200	
Forward Voltage <sup>a</sup>	$V_{SD}$	$I_F = 60\text{ A}, V_{GS} = 0\text{ V}$		1.0	1.5	V
Reverse Recovery Time	$t_{rr}$	$I_F = 60\text{ A}, di/dt = 100\text{ A}/\mu\text{s}$		45	70	ns
Peak Reverse Recovery Current	$I_{RM(REC)}$			2.5	5	A
Reverse Recovery Charge	$Q_{rr}$			0.06	0.18	$\mu\text{C}$

Notes:

- a. Pulse test; pulse width  $\leq 300\text{ }\mu\text{s}$ , duty cycle  $\leq 2\%$ .
- b. Guaranteed by design, not subject to production testing.
- c. Independent of operating temperature.

Stresses beyond those listed under "Absolute Maximum Ratings" may cause permanent damage to the device. These are stress ratings only, and functional operation of the device at these or any other conditions beyond those indicated in the operational sections of the specifications is not implied. Exposure to absolute maximum rating conditions for extended periods may affect device reliability.

**TYPICAL CHARACTERISTICS** 25 °C, unless otherwise noted

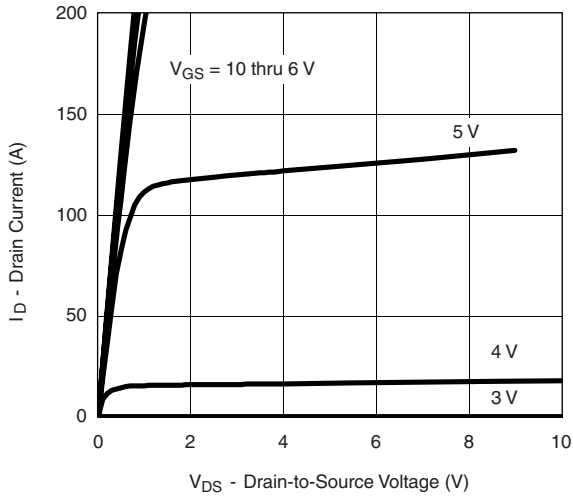

**Output Characteristics**

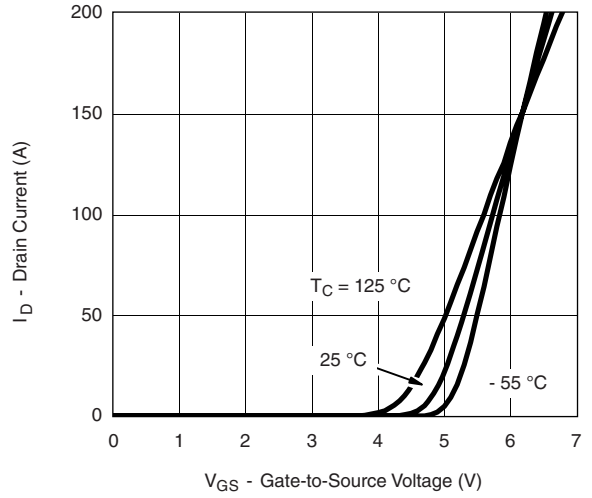

**Transfer Characteristics**

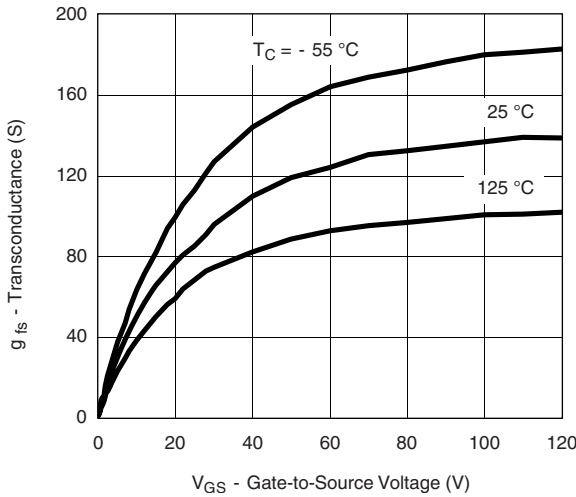

**Transconductance**

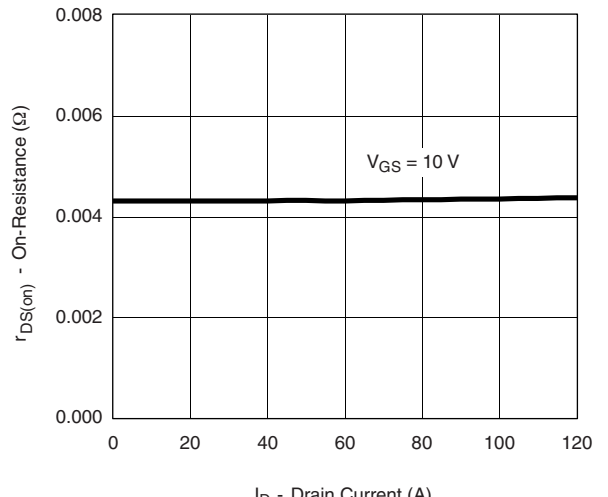

**On-Resistance vs. Drain Current**

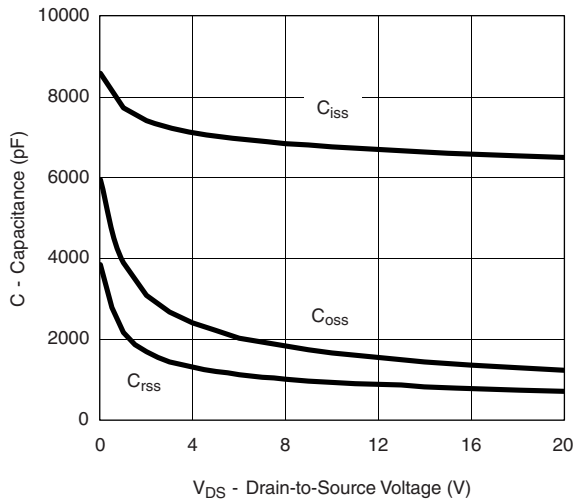

**Capacitance**

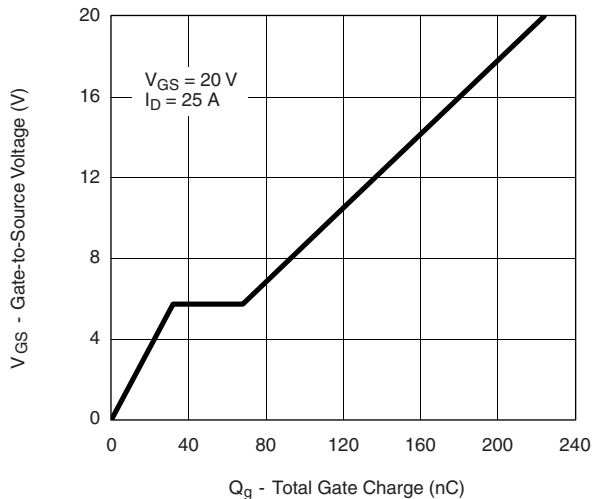

**Gate Charge**

### TYPICAL CHARACTERISTICS 25 °C, unless otherwise noted

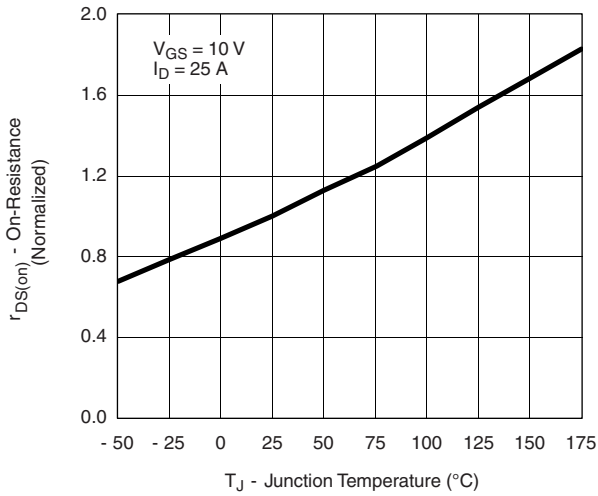

**On-Resistance vs. Junction Temperature**

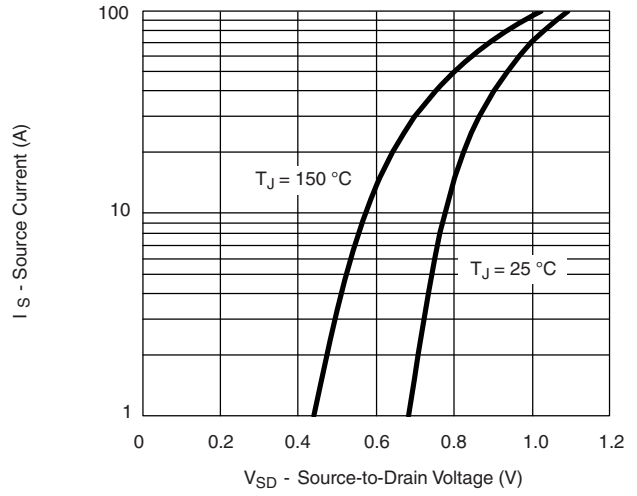

**Source-Drain Diode Forward Voltage**

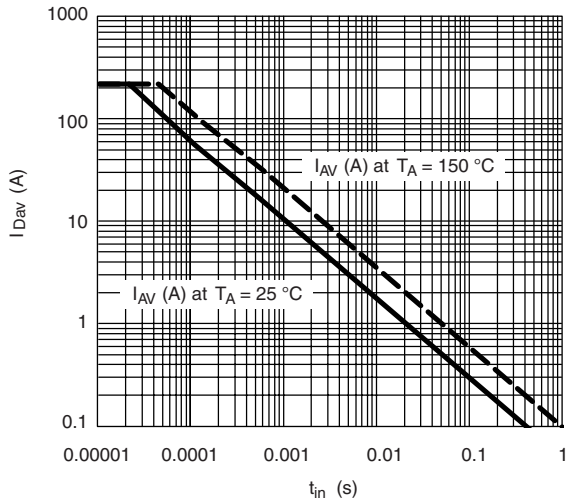

**Avalanche Current vs. Time**

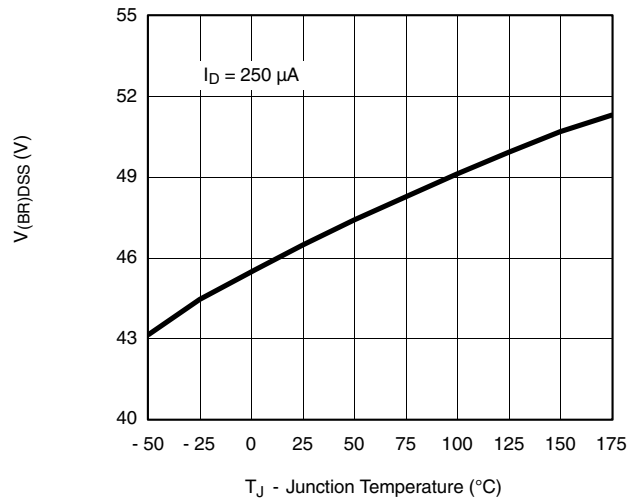

**Drain Source Breakdown vs. Junction Temperature**

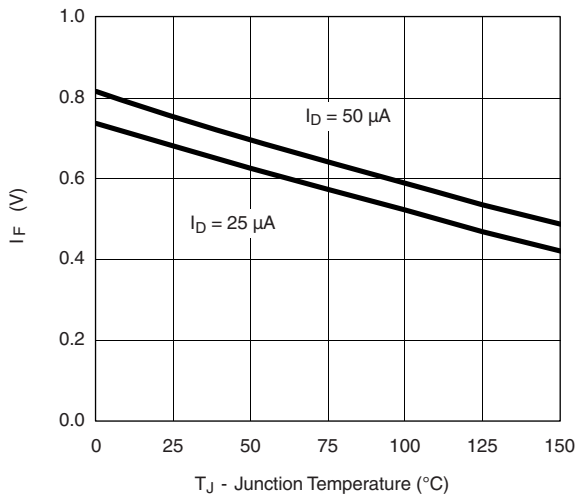

**Sense Diode Forward Voltage vs. Temperature**

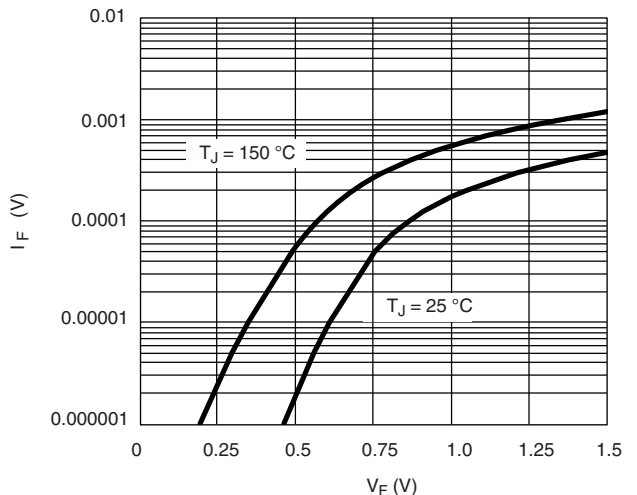

**Sense Diode Forward Voltage**

**THERMAL RATINGS**

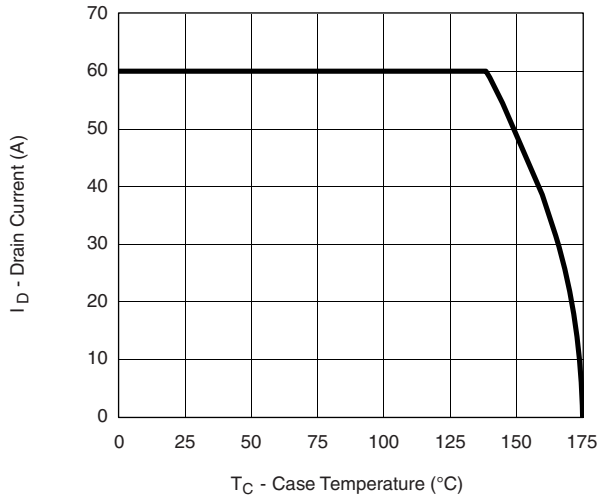

**Maximum Avalanche and Drain Current vs. Case Temperature**

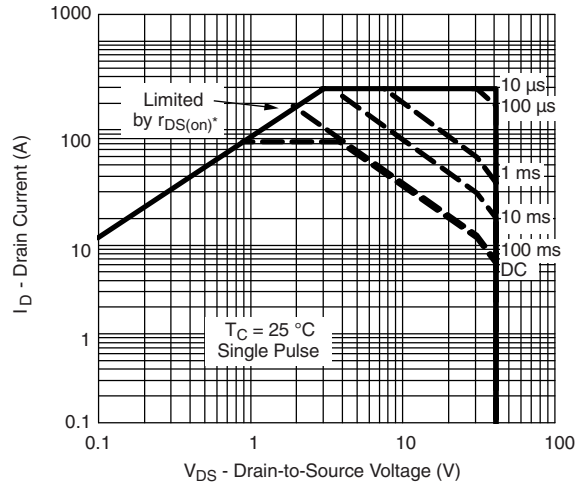

**Safe Operating Area**  
\*  $V_{GS} >$  minimum  $V_{GS}$  at which  $r_{DS(on)}$  is specified

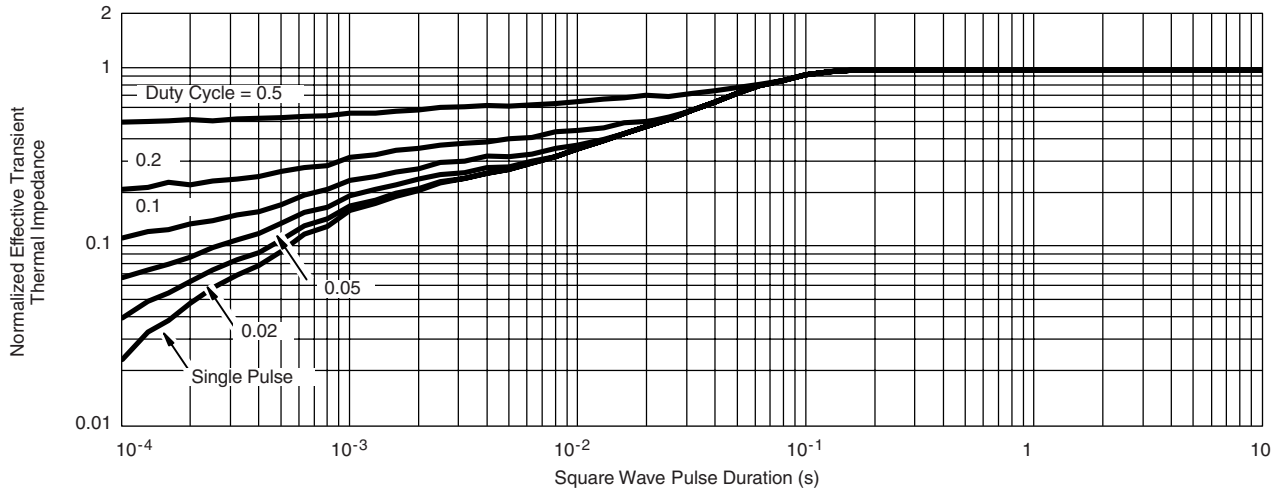

**Normalized Thermal Transient Impedance, Junction-to-Case**

Vishay Siliconix maintains worldwide manufacturing capability. Products may be manufactured at one of several qualified locations. Reliability data for Silicon Technology and Package Reliability represent a composite of all qualified locations. For related documents such as package/tape drawings, part marking, and reliability data, see <http://www.vishay.com/ppg?72430>.



## Disclaimer

ALL PRODUCT, PRODUCT SPECIFICATIONS AND DATA ARE SUBJECT TO CHANGE WITHOUT NOTICE TO IMPROVE RELIABILITY, FUNCTION OR DESIGN OR OTHERWISE.

Vishay Intertechnology, Inc., its affiliates, agents, and employees, and all persons acting on its or their behalf (collectively, "Vishay"), disclaim any and all liability for any errors, inaccuracies or incompleteness contained in any datasheet or in any other disclosure relating to any product.

Vishay makes no warranty, representation or guarantee regarding the suitability of the products for any particular purpose or the continuing production of any product. To the maximum extent permitted by applicable law, Vishay disclaims (i) any and all liability arising out of the application or use of any product, (ii) any and all liability, including without limitation special, consequential or incidental damages, and (iii) any and all implied warranties, including warranties of fitness for particular purpose, non-infringement and merchantability.

Statements regarding the suitability of products for certain types of applications are based on Vishay's knowledge of typical requirements that are often placed on Vishay products in generic applications. Such statements are not binding statements about the suitability of products for a particular application. It is the customer's responsibility to validate that a particular product with the properties described in the product specification is suitable for use in a particular application. Parameters provided in datasheets and/or specifications may vary in different applications and performance may vary over time. All operating parameters, including typical parameters, must be validated for each customer application by the customer's technical experts. Product specifications do not expand or otherwise modify Vishay's terms and conditions of purchase, including but not limited to the warranty expressed therein.

Except as expressly indicated in writing, Vishay products are not designed for use in medical, life-saving, or life-sustaining applications or for any other application in which the failure of the Vishay product could result in personal injury or death. Customers using or selling Vishay products not expressly indicated for use in such applications do so at their own risk. Please contact authorized Vishay personnel to obtain written terms and conditions regarding products designed for such applications.

No license, express or implied, by estoppel or otherwise, to any intellectual property rights is granted by this document or by any conduct of Vishay. Product names and markings noted herein may be trademarks of their respective owners.

## Material Category Policy

**Vishay Intertechnology, Inc. hereby certifies that all its products that are identified as RoHS-Compliant fulfill the definitions and restrictions defined under Directive 2011/65/EU of The European Parliament and of the Council of June 8, 2011 on the restriction of the use of certain hazardous substances in electrical and electronic equipment (EEE) - recast, unless otherwise specified as non-compliant.**

**Please note that some Vishay documentation may still make reference to RoHS Directive 2002/95/EC. We confirm that all the products identified as being compliant to Directive 2002/95/EC conform to Directive 2011/65/EU.**

**Vishay Intertechnology, Inc. hereby certifies that all its products that are identified as Halogen-Free follow Halogen-Free requirements as per JEDEC JS709A standards. Please note that some Vishay documentation may still make reference to the IEC 61249-2-21 definition. We confirm that all the products identified as being compliant to IEC 61249-2-21 conform to JEDEC JS709A standards.**



Компания «ЭлектроПласт» предлагает заключение долгосрочных отношений при поставках импортных электронных компонентов на взаимовыгодных условиях!

Наши преимущества:

- Оперативные поставки широкого спектра электронных компонентов отечественного и импортного производства напрямую от производителей и с крупнейших мировых складов;
- Поставка более 17-ти миллионов наименований электронных компонентов;
- Поставка сложных, дефицитных, либо снятых с производства позиций;
- Оперативные сроки поставки под заказ (от 5 рабочих дней);
- Экспресс доставка в любую точку России;
- Техническая поддержка проекта, помощь в подборе аналогов, поставка прототипов;
- Система менеджмента качества сертифицирована по Международному стандарту ISO 9001;
- Лицензия ФСБ на осуществление работ с использованием сведений, составляющих государственную тайну;
- Поставка специализированных компонентов (Xilinx, Altera, Analog Devices, Intersil, Interpoint, Microsemi, Aeroflex, Peregrine, Syfer, Eurofarad, Texas Instrument, Miteq, Cobham, E2V, MA-COM, Hittite, Mini-Circuits, General Dynamics и др.);

Помимо этого, одним из направлений компании «ЭлектроПласт» является направление «Источники питания». Мы предлагаем Вам помощь Конструкторского отдела:

- Подбор оптимального решения, техническое обоснование при выборе компонента;
- Подбор аналогов;
- Консультации по применению компонента;
- Поставка образцов и прототипов;
- Техническая поддержка проекта;
- Защита от снятия компонента с производства.



#### Как с нами связаться

**Телефон:** 8 (812) 309 58 32 (многоканальный)

**Факс:** 8 (812) 320-02-42

**Электронная почта:** [org@eplast1.ru](mailto:org@eplast1.ru)

**Адрес:** 198099, г. Санкт-Петербург, ул. Калинина, дом 2, корпус 4, литера А.