

Barrier Strip Filtered Terminal Blocks

The barrier strip filtered terminal block is designed to provide excellent EMI/RFI filtering of AC and DC power lines and control lines. This terminal block is available in various sizes, with terminals for soldering or spade lugs. Application examples include filtering power supplies in telecommunications equipment, metering, industrial controls, instrumentation and EDP equipment.

Features

- UL recognized and CSA approved for DC voltages
- E133076, UL 1059
- LR92537, CSA STD 22.2 N°158-1987 and ECN584B
- Filter element provides high insertion loss for EMI/RFI filtering of AC and DC power and control lines
- Rugged construction provides protection to filtering element; especially useful for repeated changes in wiring or field connections
- 2 to 6 terminals available (combine if larger number of terminals needed)
- Cost-effective solution for industrial interconnection EMI filtering problems
- Termination options available: straight lead, male or female disconnects, pigtail (12 AWG = 0.081" (2.05mm); 22 AWG = 0.025" (0.64mm))
- Available in RoHS compliant versions

Circuit Schematic

Pi Filter

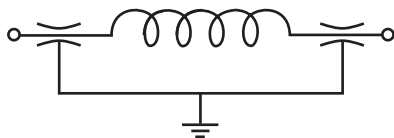

Ordering Information

Example: **52-160-006-A AOO**

The part number shown represents a barrier strip terminal block with six terminals and rated for 20 Amps. Male disconnects (.250") are the method of termination.

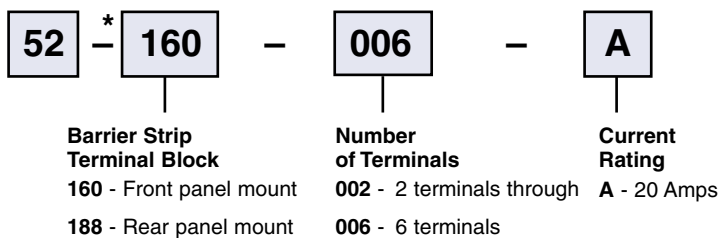

For instructions on soldering to filter terminals, please refer to page FA4 in filter plate section.

* Replace "-" with "F" for RoHS complaint version



Mechanical Specifications

- Center Spacing438" (11.1 mm)
 Wire Size AWG #12 max for 20A
 Screw Size 20A - #6-32, zinc-plated
 phillslot screws
 Molded Material Black, UL rated 94VO thermoplastic
 Tightening Torque 9 in.-lbs. max.
 Terminal Brass, tin-plated

Electrical Specifications

- Operating Temperature . . -55° C to 105° C
 Working Voltage 100VDC
 Capacitance 2,500 pF to 5,200 pF
 Dielectric
 Withstanding Voltage . . . 1700VDC
 Current Rating 20A
 D.C. Resistance01 ohms max.

Typical Loss (dB) In 50 Ohm Circuit

Frequency	Insertion Loss (dB)
30 MHz	22
50 MHz	32
100 MHz	48
300 MHz	70
500 MHz	75
1000 MHz	75

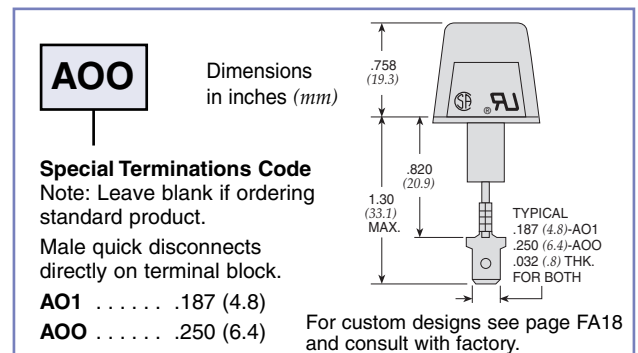

Barrier Strip Filtered Terminal Blocks

Front panel mount

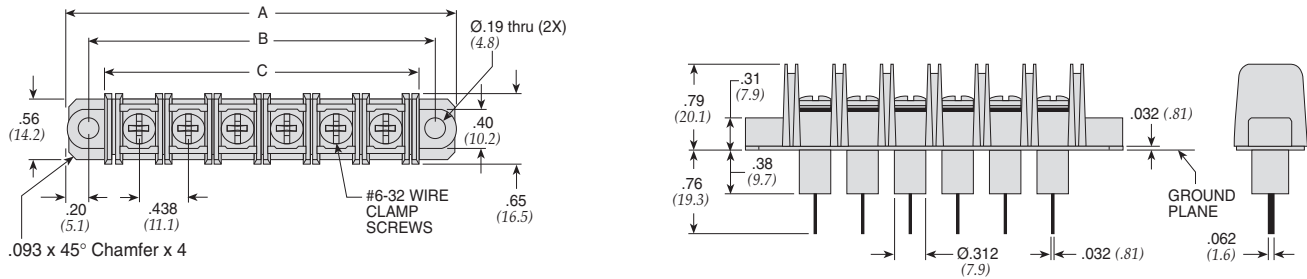

20 Amps

Dimensions in inches (mm)

Part Number	Number of Circuits	in. A (mm)	in. B (mm)	in. C (mm)
€ 52-160-002-A	2	1.71 (43.4)	1.31 (33.3)	1.02 (25.9)
52-160-003-A	3	2.15 (54.6)	1.75 (44.5)	1.46 (37.1)
52-160-004-A	4	2.59 (65.8)	2.19 (55.6)	1.90 (48.3)
52-160-005-A	5	3.02 (76.7)	2.62 (66.5)	2.32 (58.9)
52-160-006-A	6	3.46 (87.9)	3.06 (77.7)	2.77 (70.4)

€ Also available through API's authorized European distributors/agents.

Rear panel mount

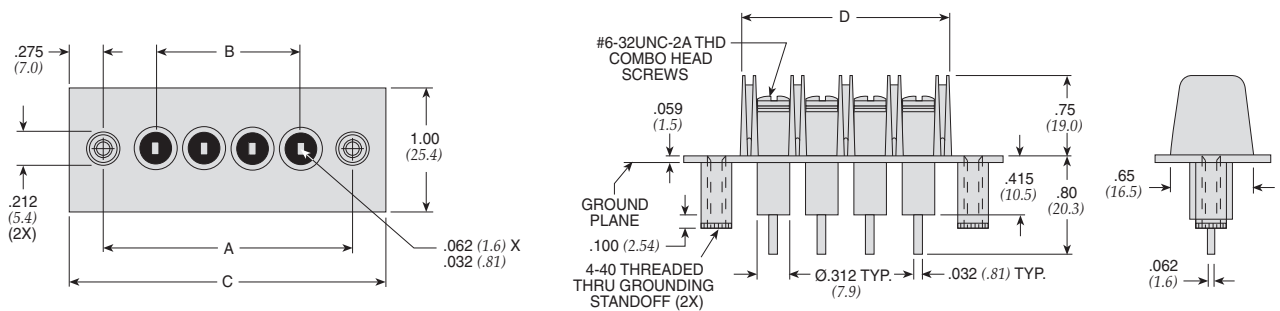

20 Amps

Dimensions in inches (mm)

Part Number	Number of Circuits	in. A (mm)	in. B (mm)	in. C (mm)	in. D (mm)
52-188-002-A	2	1.31 (33.3)	.438 (11.1)	1.86 (47.3)	1.02 (25.9)
52-188-003-A	3	1.75 (44.4)	.875 (22.2)	2.30 (58.4)	1.46 (37.1)
52-188-004-A	4	2.19 (55.6)	1.313 (33.3)	2.74 (69.5)	1.90 (48.3)
52-188-005-A	5	2.62 (66.6)	1.750 (44.4)	3.17 (80.6)	2.32 (58.9)
52-188-006-A	6	3.06 (77.7)	2.188 (55.6)	3.61 (91.7)	2.77 (70.4)

250 Volt AC Rated Filtered Terminal Blocks

API Technologies' Spectrum Control line of filtered terminal block provides superior EMI/RFI filtering of AC power and control lines. This terminal block is available in various sizes, with terminals for soldering, spade lugs, or wire pigtails. Termination options available: straight lead male or female disconnects, or wire pigtails in lengths to your specification.

Features

- UL recognized and CSA approved for AC voltages.
- E133076, UL 1059.
- LR92537, CSA STD 22.2 N°158-1987 and ECN584B.
- Termination options available: straight lead, male or female disconnects, pigtail (12 AWG-22 AWG).

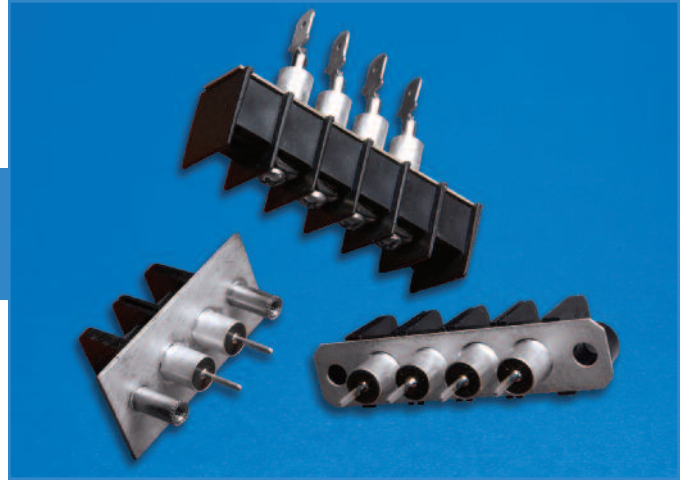

Applications

- Metering equipment
- Programmable controllers
- Industrial process control
- Heavy equipment controls
- Power supplies
- Regulators
- Surge sensing equipment
- Power factor correction
- Telecommunications power management, ATM, Sonet, etc.
- Medical equipment

Specifications

ELECTRICAL

- Operating Temperature:* -55° C to +105° C
Voltage Rating: 250VAC
Current Rating: 20 Amps
Wire Range: 12-22AWG
Torque: 9 lb-in.
Capacitance: 2000pF to 5200pF
Dielectric Withstanding Voltage: 1500VAC @ 25° C

MECHANICAL

- Center Spacing:* .438" (11.1 mm)
Wire Size: AWG #12 max. for 20 Amp
Screw Size: 20A - #6-32, zinc plated phillslot
Molded Material: UL rated 94VO polyamide
Tightening Torque: 9 in.-lbs. max.
Terminal Options: straight lead, male or female disconnects, pigtail

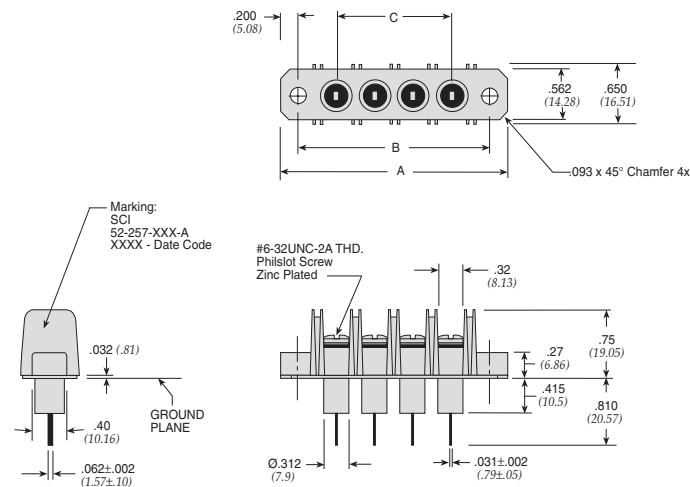

Part Number	Number of Circuits	in. A (mm)	in. B (mm)	in. C (mm)
52-257-002	2	1.71 (43.4)	1.31 (33.3)	1.02 (25.9)
52-257-003	3	2.15 (54.6)	1.75 (44.5)	1.46 (37.1)
52-257-004	4	2.59 (65.8)	2.19 (55.6)	1.90 (48.3)
52-257-005	5	3.02 (76.7)	2.62 (66.5)	2.32 (58.9)
52-257-006	6	3.46 (87.9)	3.06 (77.7)	2.77 (70.4)

Dimensions in inches (mm)



Компания «ЭлектроПласт» предлагает заключение долгосрочных отношений при поставках импортных электронных компонентов на взаимовыгодных условиях!

Наши преимущества:

- Оперативные поставки широкого спектра электронных компонентов отечественного и импортного производства напрямую от производителей и с крупнейших мировых складов;
- Поставка более 17-ти миллионов наименований электронных компонентов;
- Поставка сложных, дефицитных, либо снятых с производства позиций;
- Оперативные сроки поставки под заказ (от 5 рабочих дней);
- Экспресс доставка в любую точку России;
- Техническая поддержка проекта, помощь в подборе аналогов, поставка прототипов;
- Система менеджмента качества сертифицирована по Международному стандарту ISO 9001;
- Лицензия ФСБ на осуществление работ с использованием сведений, составляющих государственную тайну;
- Поставка специализированных компонентов (Xilinx, Altera, Analog Devices, Intersil, Interpoint, Microsemi, Aeroflex, Peregrine, Syfer, Eurofarad, Texas Instrument, Miteq, Cobham, E2V, MA-COM, Hittite, Mini-Circuits, General Dynamics и др.);

Помимо этого, одним из направлений компании «ЭлектроПласт» является направление «Источники питания». Мы предлагаем Вам помощь Конструкторского отдела:

- Подбор оптимального решения, техническое обоснование при выборе компонента;
- Подбор аналогов;
- Консультации по применению компонента;
- Поставка образцов и прототипов;
- Техническая поддержка проекта;
- Защита от снятия компонента с производства.



Как с нами связаться

Телефон: 8 (812) 309 58 32 (многоканальный)

Факс: 8 (812) 320-02-42

Электронная почта: org@eplast1.ru

Адрес: 198099, г. Санкт-Петербург, ул. Калинина, дом 2, корпус 4, литера А.