

## Industrial Rotary Position Sensor Bushing Mount Type, Conductive Plastic

**FEATURES**

- Fully sealed for high immunity to environmental damage
- Excellent temperature stability
- Rotational life exceeds 2 million revolutions
- Low cost and wide range of options
- Stainless steel shaft
- Shock to 30 g vibration to 15 g at 10 Hz to 2000 Hz

**QUICK REFERENCE DATA**

Sensor type	ROTATIONAL, conductive plastic
Output type	Output by turrets
Market appliance	Industrial
Dimensions	15.81 mm x 17.46 mm



**ELECTRICAL SPECIFICATIONS**

PARAMETER	
Standard resistance	1 kΩ to 100 kΩ
Capability range	200 kΩ
Resistance tolerance	± 20 %
Linearity	± 2 %
Power rating	1.0 W at 85 °C
Electrical travel	240° ± 4°
Dielectric withstanding	500 V <sub>RMS</sub> at 60 Hz minimum
Output smoothness	0.2 % maximum

**MECHANICAL SPECIFICATIONS**

PARAMETER	
Bearing type	Sleeve
Mechanical rotation	250° ± 2°
Stop strength	10 in - lb minimum, 11.5 kg/cm
Starting torque	3.0 o.z - in maximum, 216 g/cm
Running torque	3.0 oz. - in maximum, 216 g/cm

**ORDERING INFORMATION/DESCRIPTION**

657	B	F	0			50 kΩ	B10
MODEL	STYLE	SHAFT OPTIONS	SHAFT BUSHING OPTIONS			TOTAL RESISTANCE	PACKAGING
	<b>B</b> : Bushing	<b>R</b> - Round <b>F</b> - Flatted	 Shaft length <b>0</b> - 0.875" FMS <b>1</b> - 0.625" FMS <b>2</b> - 1.000" FMS <b>3</b> - 1.250" FMS	 Bushing length 0.375" FMS 0.250" FMS 0.500" FMS 0.750" FMS	 Flat 0.440" 0.315" 0.440" 0.440"		Box of 10 pieces

**SAP PART NUMBERING GUIDELINES**

657B	R	1	103	BO10
MODEL	END SHAFT	SHAFT AND BUSHING OPTIONS	OHMIC VALUE	PACKAGING
	<b>R</b> : Round	(see above)		

**DIMENSIONS** in inches (millimeters)

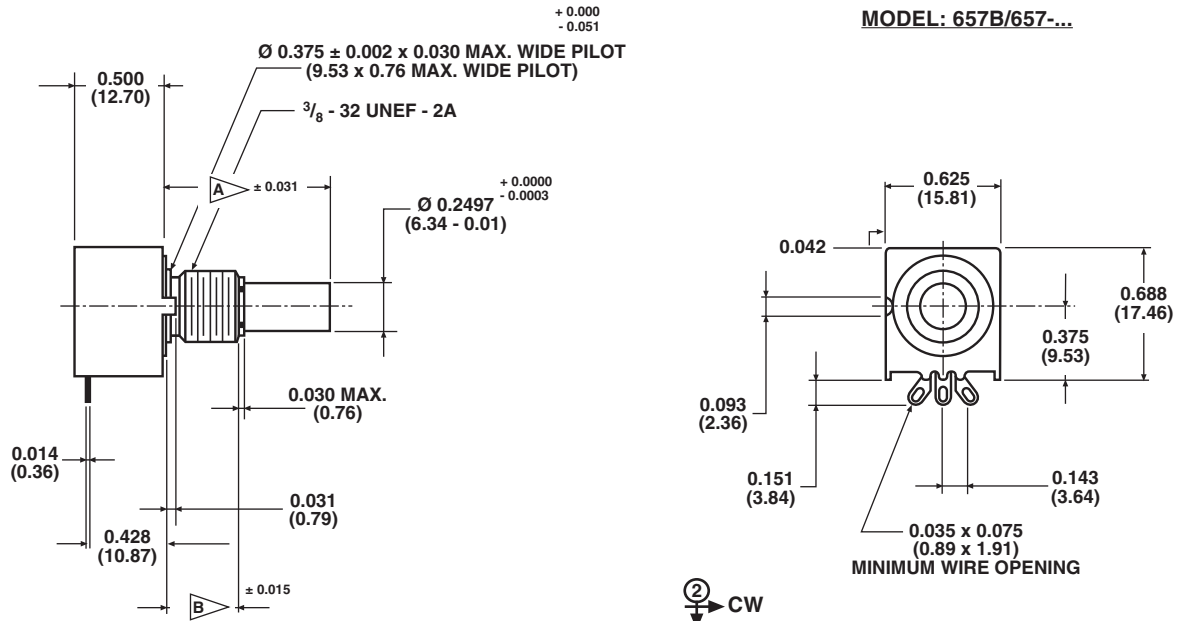

MODEL: 657B/657-...

DECIMALS: XX ± 0.01 INCHES (± 0.25 mm)  
XX ± 0.005 INCHES (± 0.13 mm) ANGLES: ± 2°

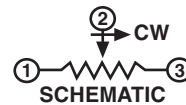

**SHAFT FLAT AND PHASING DIAGRAM**

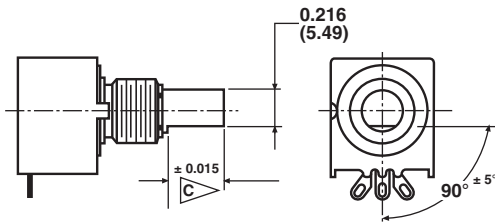

WITH SHAFT FLAT POSITIONED AS SHOWN, OUTPUT RATIO  
TO BE e/E = 0.50 ± 0.02

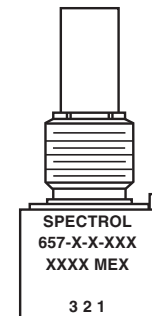

**STANDARD RESISTANCE VALUES**

CODE	RESISTANCE (Ω)
102	1K
202	2K
502	5K
103	10K
203	20K
503	50K
104	100K

**MATERIAL SPECIFICATIONS**

Shaft	Stainless steel
Bushing	Nickel plated brass
Housing	Thermoplastic
Element	Conductive plastic on alumina substrate

**ENVIRONMENTAL SPECIFICATIONS**

Rotational life	2 million revolutions
Vibration	15 g at 10 Hz to 2000 Hz
Operating temperature	-40 °C to +125 °C
Storage temperature	-55 °C to +150 °C
Temperature coefficient	± 600 ppm/°C
Shock	30 g
Resistant to solder heat	350 °C for 5 s
Moisture resistance IP rating	Sealed construction IP67* application to provide protection for wiring terminals

**Note**

- Nothing stated herein shall be construed as a guarantee of quality or durability.

**MARKING**

Unit identification	Vishay Spectrol, part number, data code, country of origin and terminal designation. Example of a marking for a standard part: 657-2-0-102
---------------------	--



## Disclaimer

ALL PRODUCT, PRODUCT SPECIFICATIONS AND DATA ARE SUBJECT TO CHANGE WITHOUT NOTICE TO IMPROVE RELIABILITY, FUNCTION OR DESIGN OR OTHERWISE.

Vishay Intertechnology, Inc., its affiliates, agents, and employees, and all persons acting on its or their behalf (collectively, "Vishay"), disclaim any and all liability for any errors, inaccuracies or incompleteness contained in any datasheet or in any other disclosure relating to any product.

Vishay makes no warranty, representation or guarantee regarding the suitability of the products for any particular purpose or the continuing production of any product. To the maximum extent permitted by applicable law, Vishay disclaims (i) any and all liability arising out of the application or use of any product, (ii) any and all liability, including without limitation special, consequential or incidental damages, and (iii) any and all implied warranties, including warranties of fitness for particular purpose, non-infringement and merchantability.

Statements regarding the suitability of products for certain types of applications are based on Vishay's knowledge of typical requirements that are often placed on Vishay products in generic applications. Such statements are not binding statements about the suitability of products for a particular application. It is the customer's responsibility to validate that a particular product with the properties described in the product specification is suitable for use in a particular application. Parameters provided in datasheets and/or specifications may vary in different applications and performance may vary over time. All operating parameters, including typical parameters, must be validated for each customer application by the customer's technical experts. Product specifications do not expand or otherwise modify Vishay's terms and conditions of purchase, including but not limited to the warranty expressed therein.

Except as expressly indicated in writing, Vishay products are not designed for use in medical, life-saving, or life-sustaining applications or for any other application in which the failure of the Vishay product could result in personal injury or death. Customers using or selling Vishay products not expressly indicated for use in such applications do so at their own risk. Please contact authorized Vishay personnel to obtain written terms and conditions regarding products designed for such applications.

No license, express or implied, by estoppel or otherwise, to any intellectual property rights is granted by this document or by any conduct of Vishay. Product names and markings noted herein may be trademarks of their respective owners.

## Material Category Policy

**Vishay Intertechnology, Inc. hereby certifies that all its products that are identified as RoHS-Compliant fulfill the definitions and restrictions defined under Directive 2011/65/EU of The European Parliament and of the Council of June 8, 2011 on the restriction of the use of certain hazardous substances in electrical and electronic equipment (EEE) - recast, unless otherwise specified as non-compliant.**

**Please note that some Vishay documentation may still make reference to RoHS Directive 2002/95/EC. We confirm that all the products identified as being compliant to Directive 2002/95/EC conform to Directive 2011/65/EU.**

**Vishay Intertechnology, Inc. hereby certifies that all its products that are identified as Halogen-Free follow Halogen-Free requirements as per JEDEC JS709A standards. Please note that some Vishay documentation may still make reference to the IEC 61249-2-21 definition. We confirm that all the products identified as being compliant to IEC 61249-2-21 conform to JEDEC JS709A standards.**



Компания «ЭлектроПласт» предлагает заключение долгосрочных отношений при поставках импортных электронных компонентов на взаимовыгодных условиях!

Наши преимущества:

- Оперативные поставки широкого спектра электронных компонентов отечественного и импортного производства напрямую от производителей и с крупнейших мировых складов;
- Поставка более 17-ти миллионов наименований электронных компонентов;
- Поставка сложных, дефицитных, либо снятых с производства позиций;
- Оперативные сроки поставки под заказ (от 5 рабочих дней);
- Экспресс доставка в любую точку России;
- Техническая поддержка проекта, помощь в подборе аналогов, поставка прототипов;
- Система менеджмента качества сертифицирована по Международному стандарту ISO 9001;
- Лицензия ФСБ на осуществление работ с использованием сведений, составляющих государственную тайну;
- Поставка специализированных компонентов (Xilinx, Altera, Analog Devices, Intersil, Interpoint, Microsemi, Aeroflex, Peregrine, Syfer, Eurofarad, Texas Instrument, Miteq, Cobham, E2V, MA-COM, Hittite, Mini-Circuits, General Dynamics и др.);

Помимо этого, одним из направлений компании «ЭлектроПласт» является направление «Источники питания». Мы предлагаем Вам помощь Конструкторского отдела:

- Подбор оптимального решения, техническое обоснование при выборе компонента;
- Подбор аналогов;
- Консультации по применению компонента;
- Поставка образцов и прототипов;
- Техническая поддержка проекта;
- Защита от снятия компонента с производства.



#### Как с нами связаться

**Телефон:** 8 (812) 309 58 32 (многоканальный)

**Факс:** 8 (812) 320-02-42

**Электронная почта:** [org@eplast1.ru](mailto:org@eplast1.ru)

**Адрес:** 198099, г. Санкт-Петербург, ул. Калинина, дом 2, корпус 4, литера А.