

Product Description

Qorvo’s QPA1010D is a X-band high power MMIC amplifier fabricated on Qorvo’s production 0.15um GaN on SiC process (QGaN15). The QPA1010D operates from 7.9 – 11 GHz and typically provides 15 W saturated output power with power-added efficiency of 38% and large-signal gain of 18 dB. This combination of wideband performance provides the flexibility designers are looking for to improve system performance while reducing size and cost.

QPA1010D can also support a variety of operating conditions to best support system requirements. With good thermal properties, it can support a range of bias voltages and will perform well under both CW and pulse operations.

The QPA1010D is matched to 50Ω with integrated DC blocking capacitors on both RF I/O ports simplifying system integration. The wideband performance and operational flexibility allow it support satellite communication and data links, as well as, military and commercial radar systems.

The QPA1010D is 100% DC and RF tested on-wafer to ensure compliance to electrical specifications.

Lead-free and RoHS compliant.

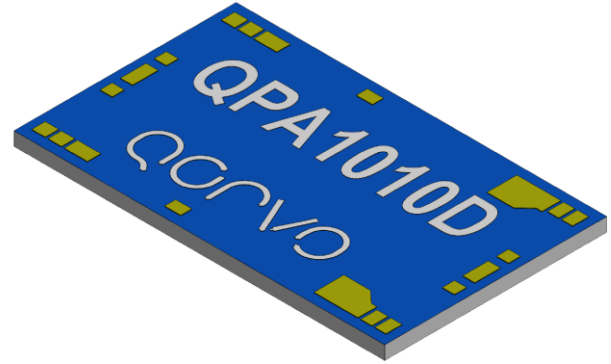

Product Features

- Frequency Range: 7.9–11 GHz
- P_{OUT}: 42 dBm at P_{IN} = 24 dBm
- PAE: 38 % at P_{IN} = 24 dBm
- Large Signal Gain: 18 dB at P_{IN} = 24 dBm
- Small Signal Gain: 25 dB
- Integrated Power Detector
- Bias: V_D = 24 V, I_{DQ} = 600 mA, V_G = -1.9 V Typical
- Pulsed V_D: PW = 100 μS, DC = 10%
- Chip Dimensions: 2.75 x 1.65 x 0.10 mm

Performance is typical across frequency. Please reference electrical specification table and data plots for more details.

Functional Block Diagram

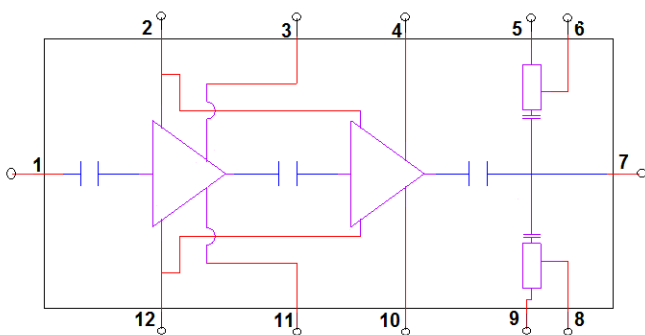

Applications

- Satellite Communications
- Data Links
- Military and Commercial Radar

Ordering Information

Part No.	Description
QPA1010D	7.9 – 11 GHz 15 W GaN Power Amplifier
QPA1010DPCB4B01	Evaluation Board

Absolute Maximum Ratings

Parameter	Value / Range
Drain Voltage (V_D)	29.5 V
Gate Voltage Range (V_G)	-8 to 0V
Drain Current (I_{D1}/I_{D2})	672 mA / 1440 mA
Gate Current (I_G)	See chart, pg. 21
Power Dissipation (P_{DISS}), 85°C, CW	32 W
Input Power (P_{IN}), CW, 50Ω, $V_D=28$ V, $I_{DQ}=600$ mA, 85 °C	30 dBm
Input Power (P_{IN}), CW, VSWR 3:1, $V_D=28$ V, $I_{DQ}=600$ mA 85 °C	30 dBm
Mounting Temperature (30 seconds)	320 °C
Storage Temperature	-55 to 150 °C

Operation of this device outside the parameter ranges given above may cause permanent damage. These are stress ratings only, and functional operation of the device at these conditions is not implied.

Electrical Specifications

Parameter		Min	Typ	Max	Units
Operational Frequency Range		7.9		11	GHz
Output Power ($P_{IN} = 24$ dBm)	7.9 GHz		41.4		dBm
	9.0 GHz		42.3		dBm
	11.0 GHz		41.9		dBm
Power Added Efficiency ($P_{IN} = 24$ dBm)	7.9 GHz		38.6		%
	9.0 GHz		44.2		%
	11.0 GHz		38.2		%
3 rd Order Intermodulation Level ($P_{OUT}/Tone= 35$ dBm)	7.9 GHz		-20		dBc
	10.0 GHz		-21		dBc
	11.0 GHz		-22		dBc
Small Signal Gain	7.9 GHz		24.6		dB
	9.0 GHz		25.2		dB
	11.0 GHz		23.1		dB
Input Return Loss	7.9 GHz		12		dB
	9.0 GHz		24		dB
	11.0 GHz		16		dB
Output Return Loss	7.9 GHz		20		dB
	9.0 GHz		9.5		dB
	11.0 GHz		12.5		dB
Output Power Temperature Coefficient (25–85 °C) ($P_{IN} = 24$ dBm)			-0.004		dB/°C
Small Signal Gain Temperature Coefficient (25–85 °C)			-0.076		dB/°C
Gate Leakage ($V_d=10$ V, $V_g=-4.0$ V, all gates together)		-6.6	-3.0	-0.0001	mA
Recommended Voltage Operations			24	28	V

Test conditions, unless otherwise noted: 25 °C, Pulsed V_D : PW = 100 μS, DC = 10%, $V_D = 24$ V, $I_{DQ} = 600$ mA, $V_G = -1.9$ V Typical

Recommended Operating Conditions

Parameter	Value / Range
Drain Voltage (V_D)	24 V
Drain Current (I_{DQ})	600 mA
Gate Voltage (V_G), Typical	-1.9 V
Temperature (T_{BASE})	-40 to +85 °C

Electrical specifications are measured at specified test conditions. Specifications are not guaranteed over all recommended operating conditions.

Performance Plots – Large Signal (Pulsed)

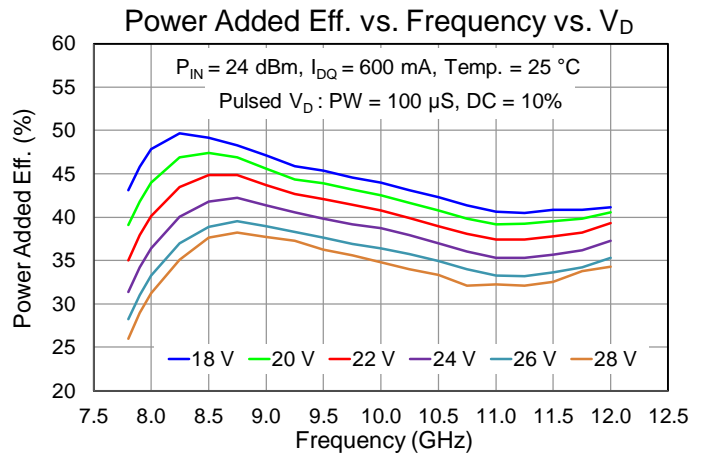
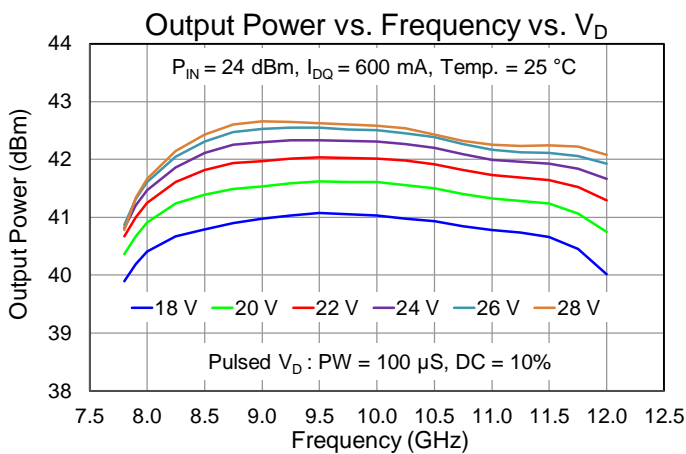
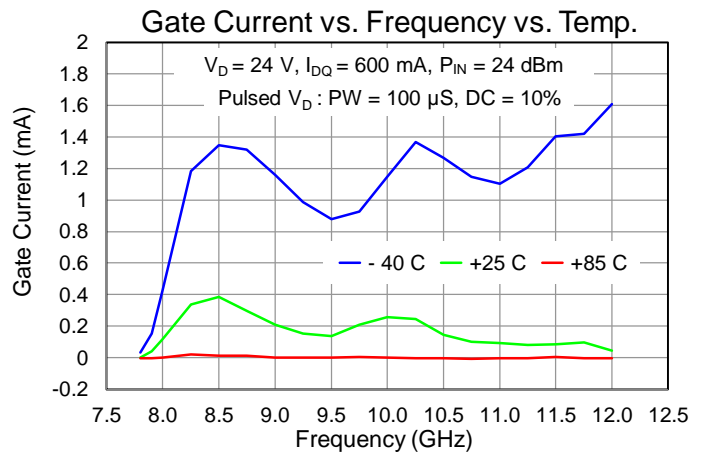
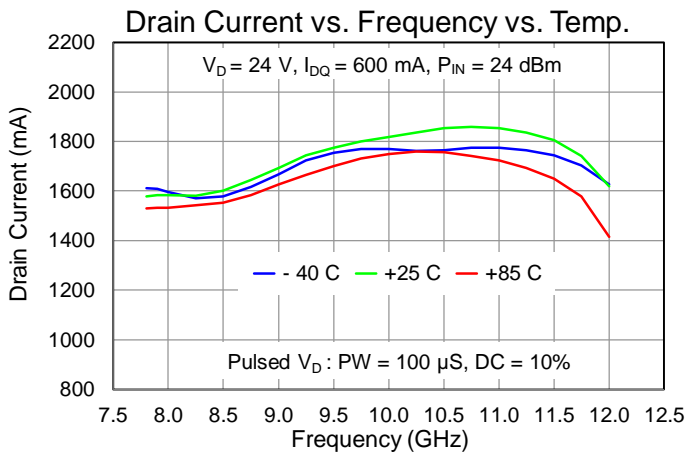
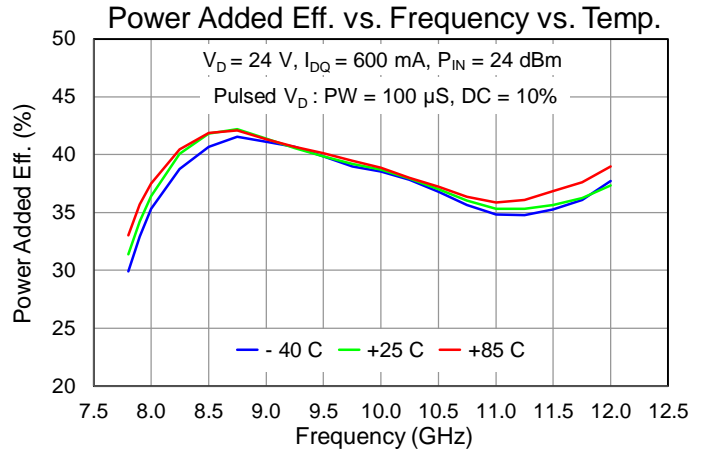
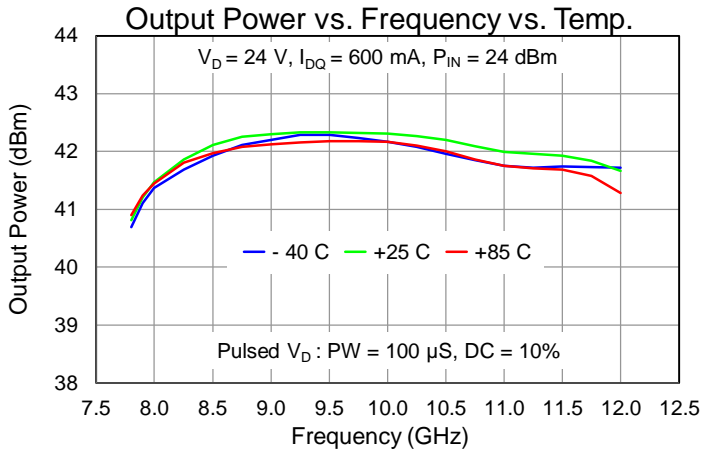

Performance Plots – Large Signal (Pulsed)

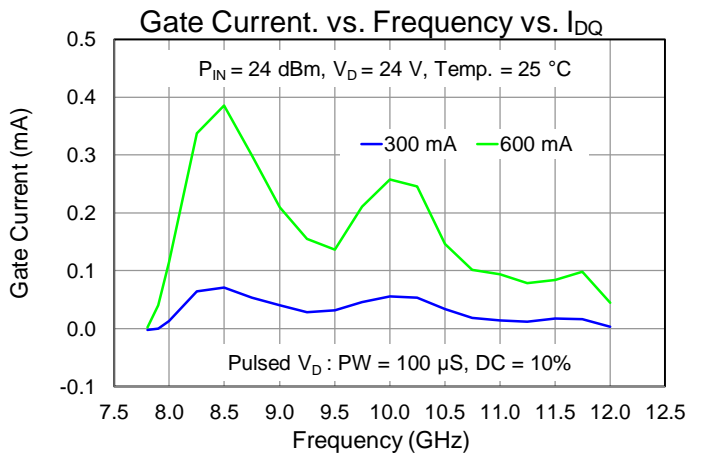
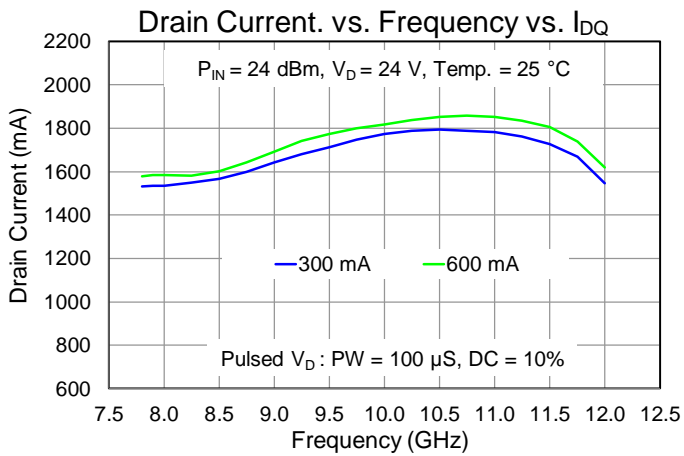
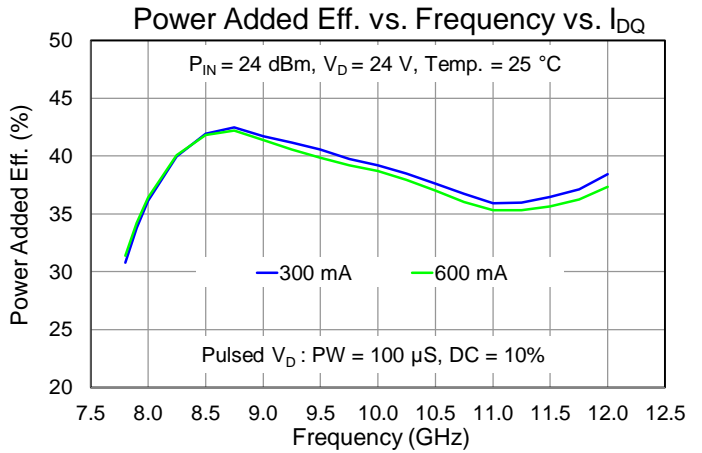
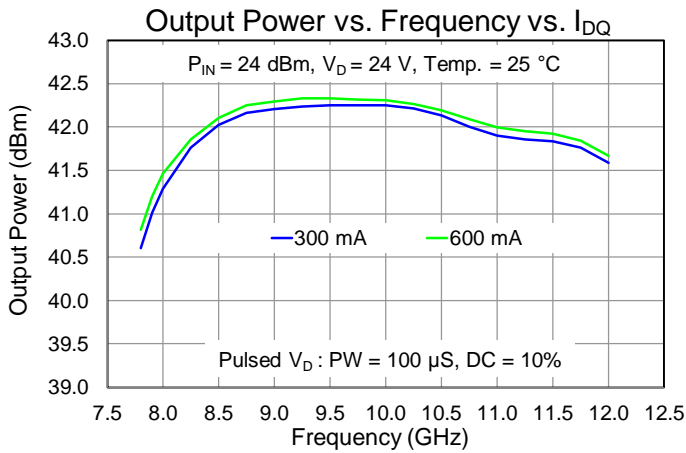
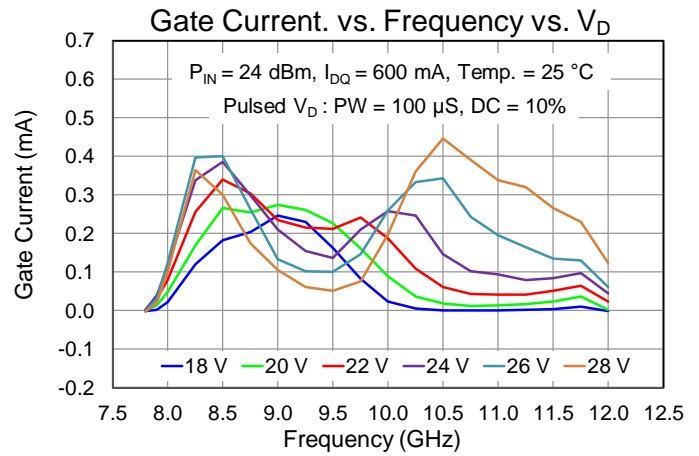
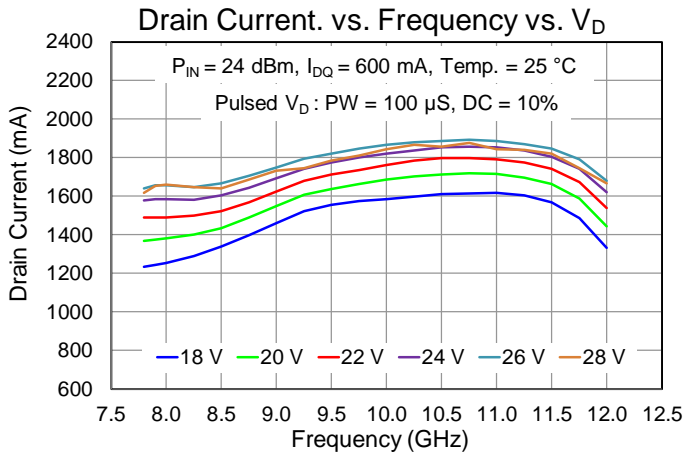

Performance Plots – Large Signal (Pulsed)

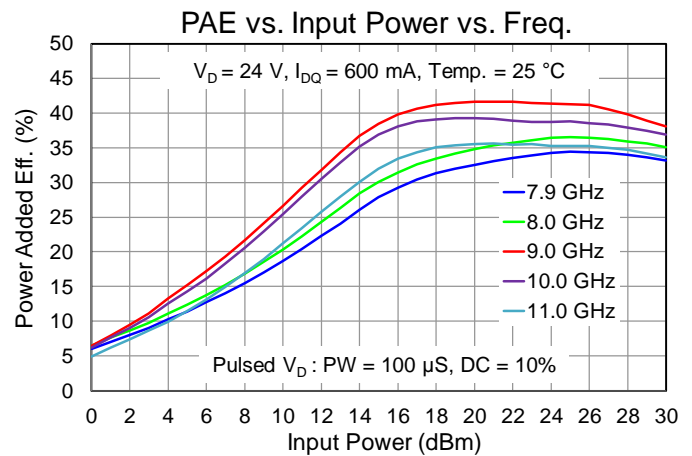
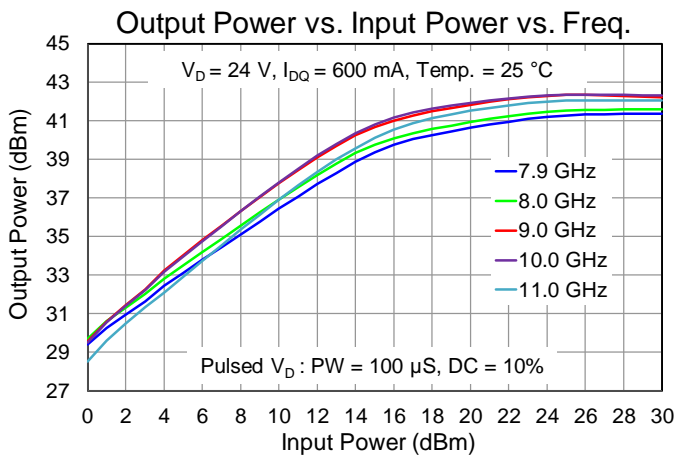
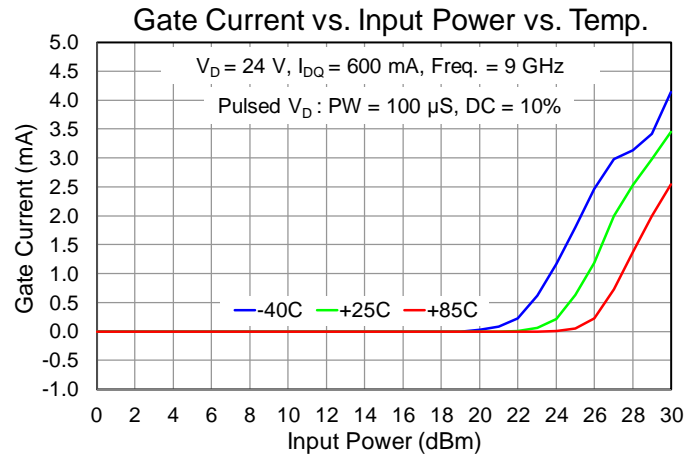
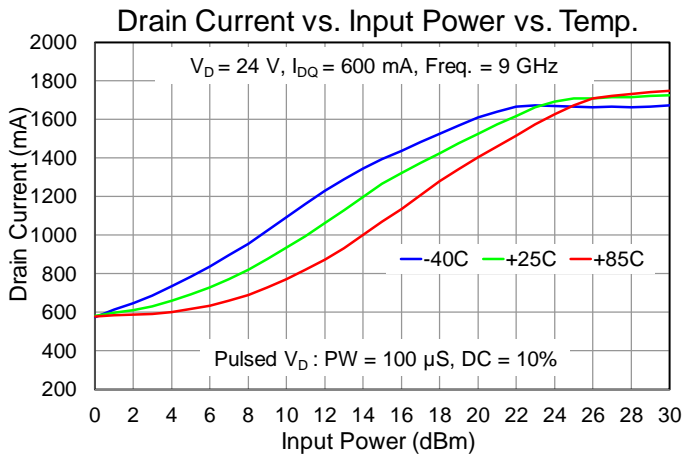
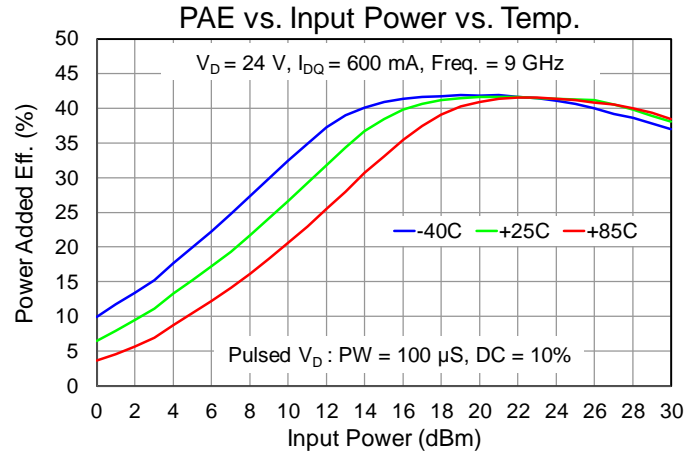
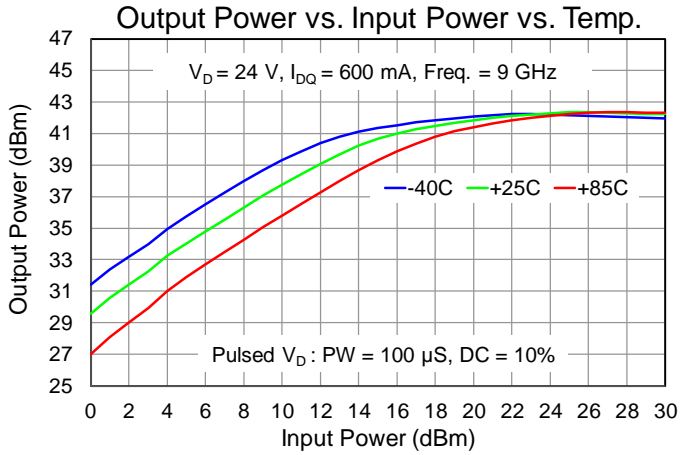

Performance Plots – Large Signal (Pulsed)

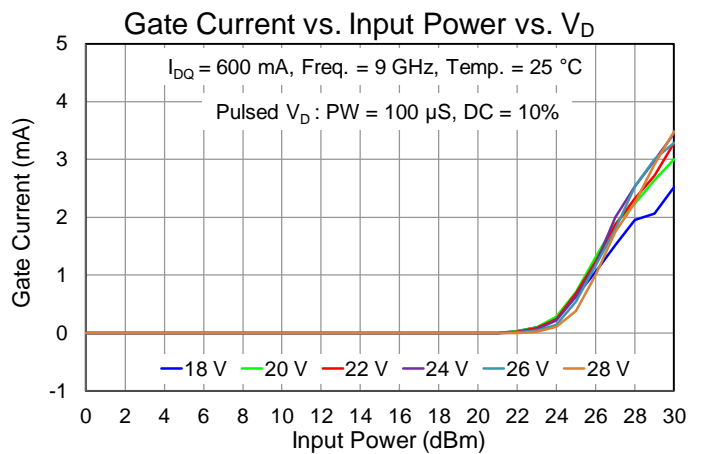
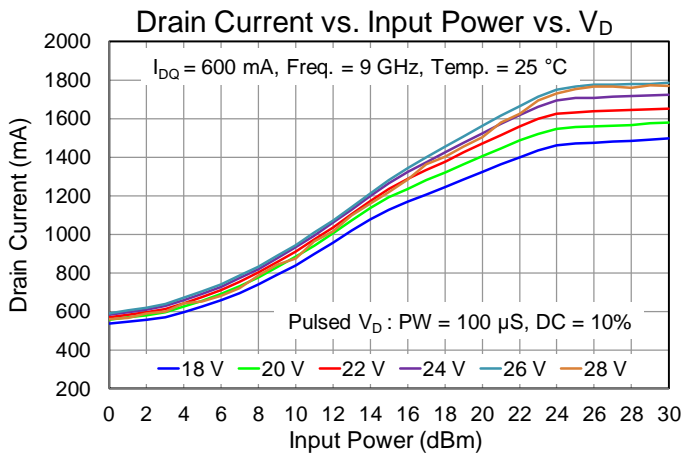
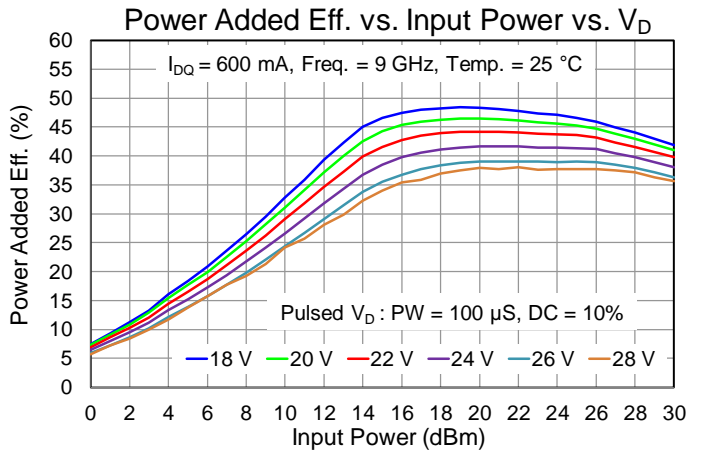
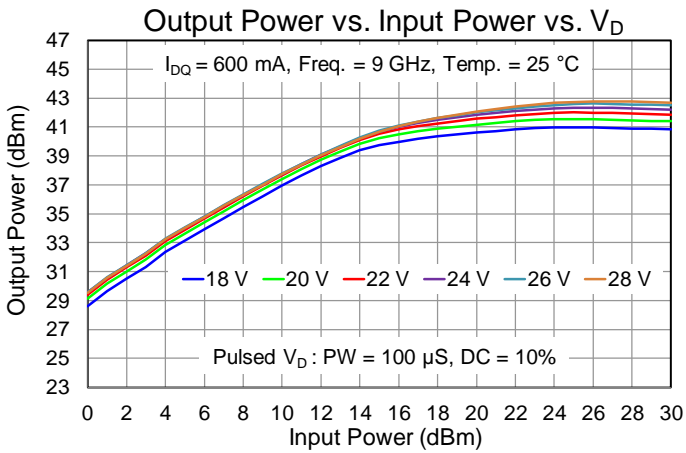
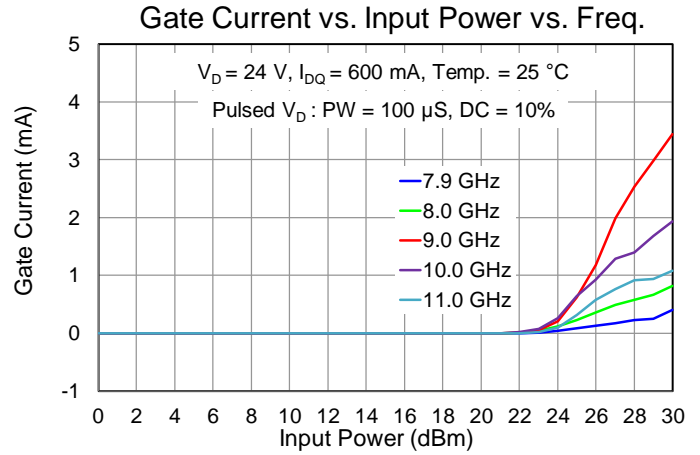
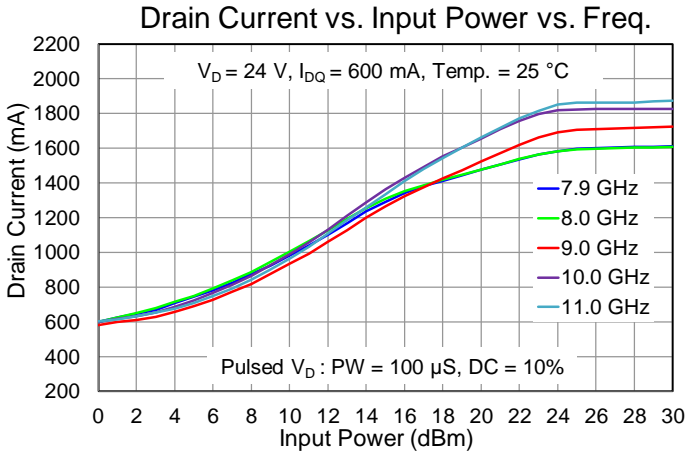

Performance Plots – Large Signal (CW)

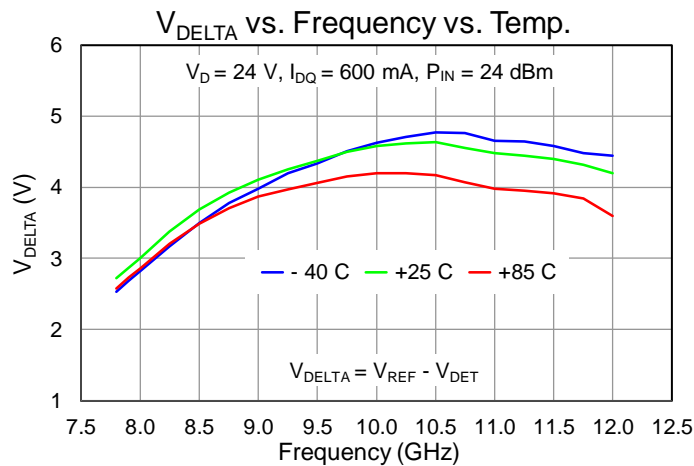
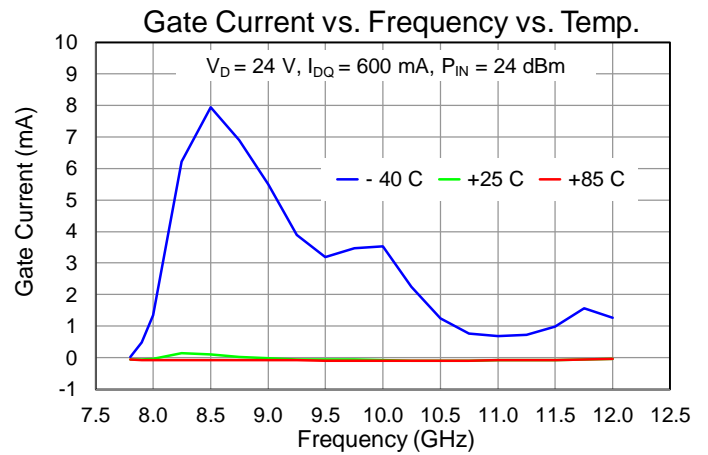
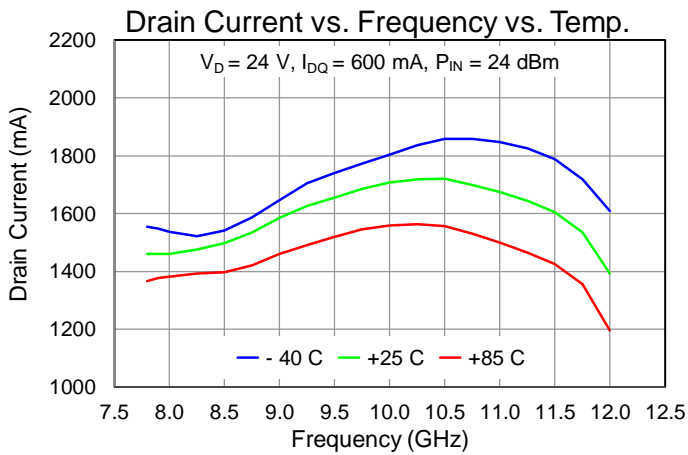
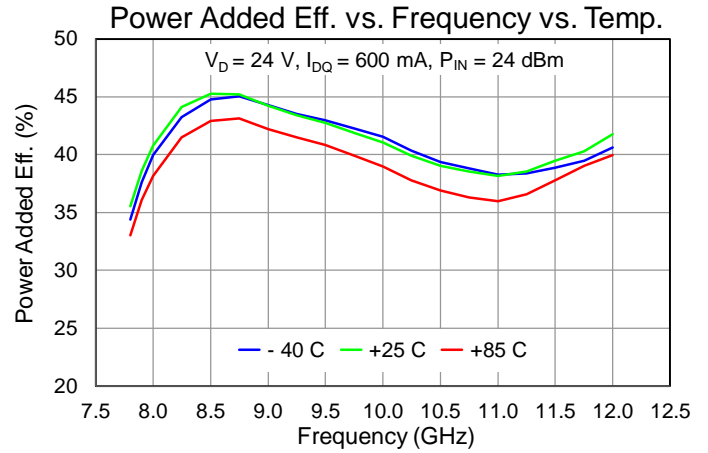
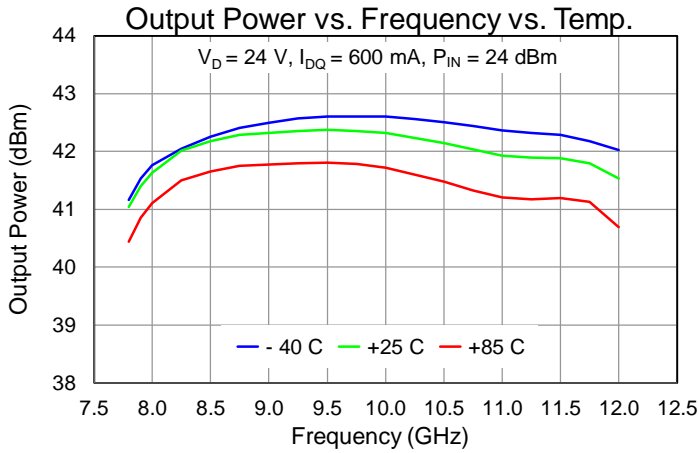

Performance Plots – Large Signal (CW)

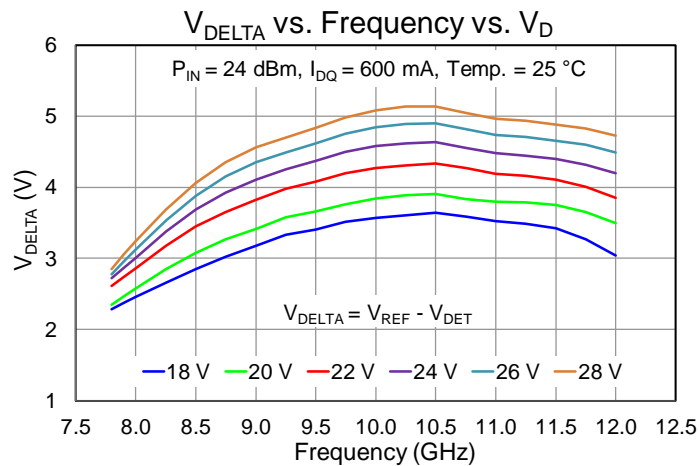
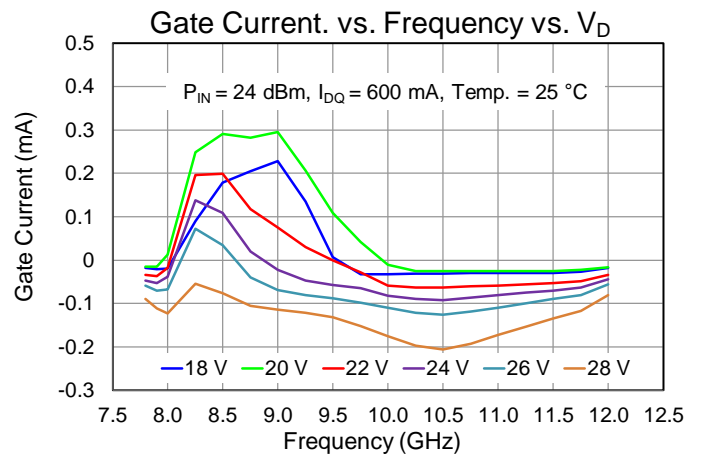
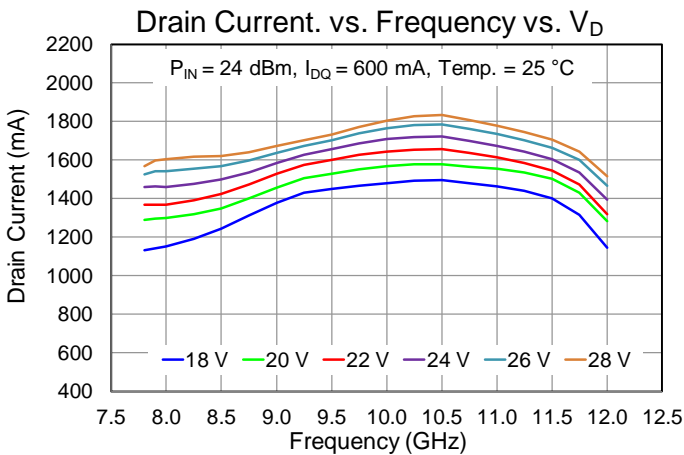
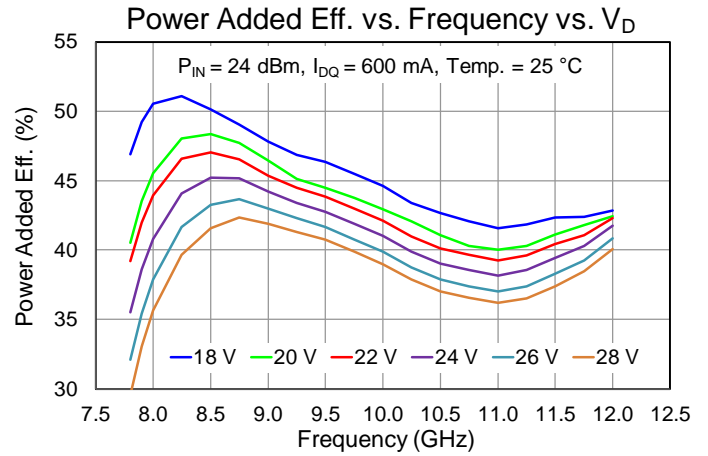
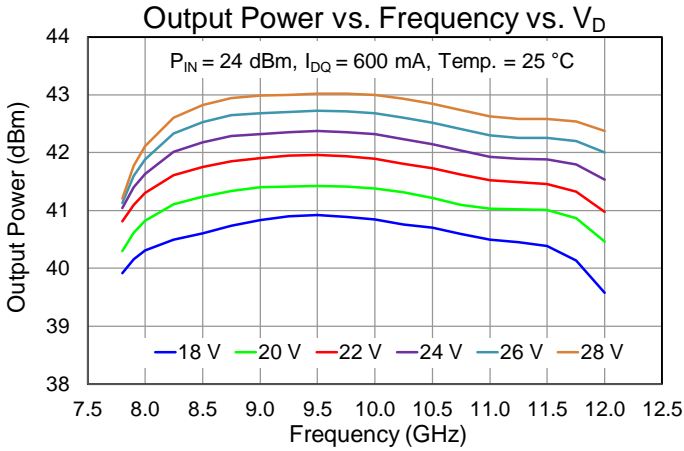

Performance Plots – Large Signal (CW)

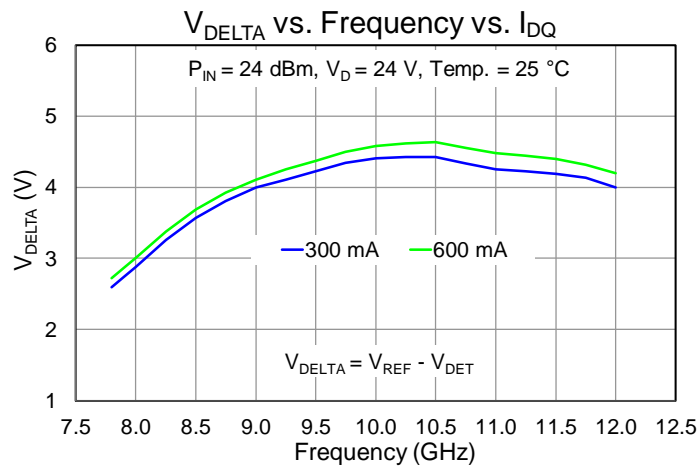
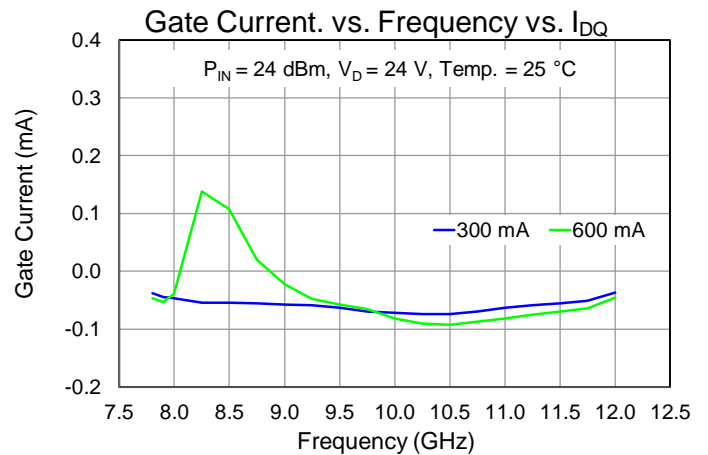
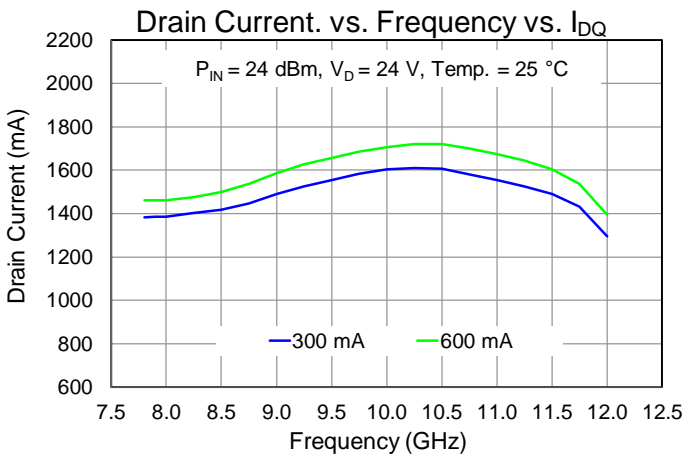
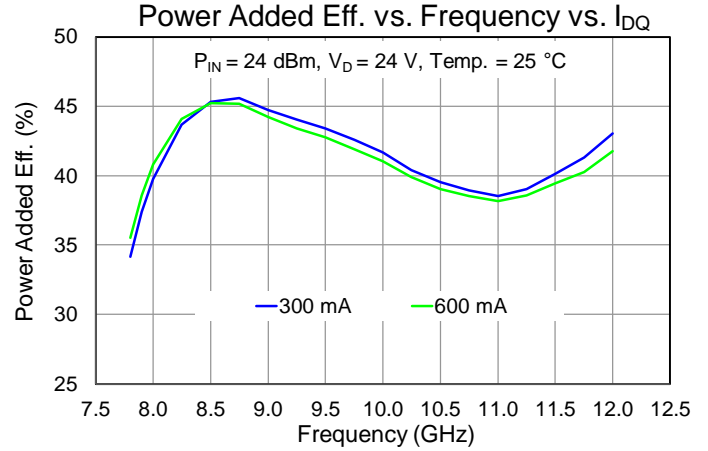
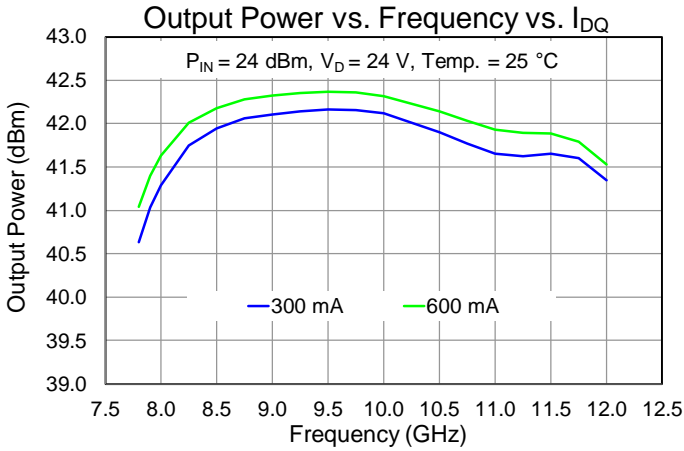

Performance Plots – Large Signal (CW)

Output Power vs. Input Power vs. Temp.

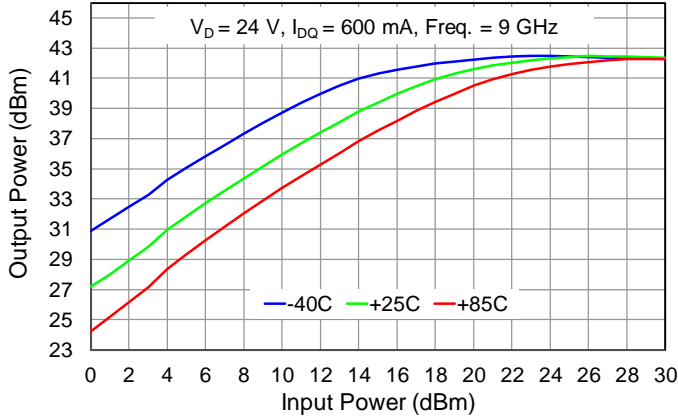

PAE vs. Input Power vs. Temp.

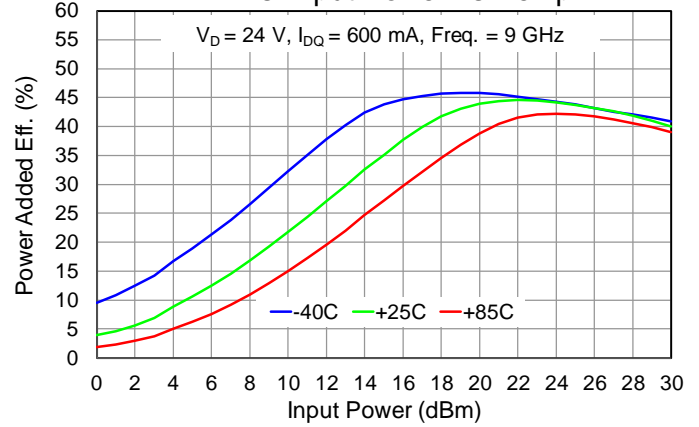

Drain Current vs. Input Power vs. Temp.

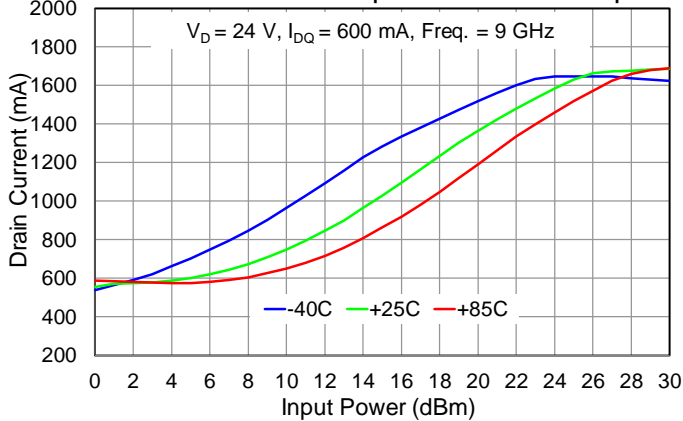

Gate Current vs. Input Power vs. Temp.

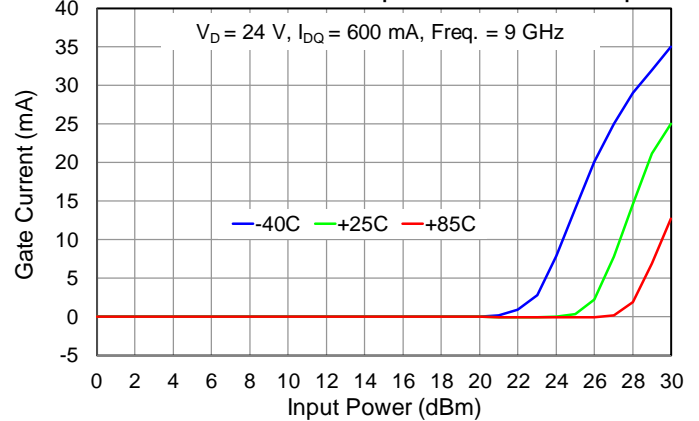

V_{Δ} vs. Input Power vs. Temp.

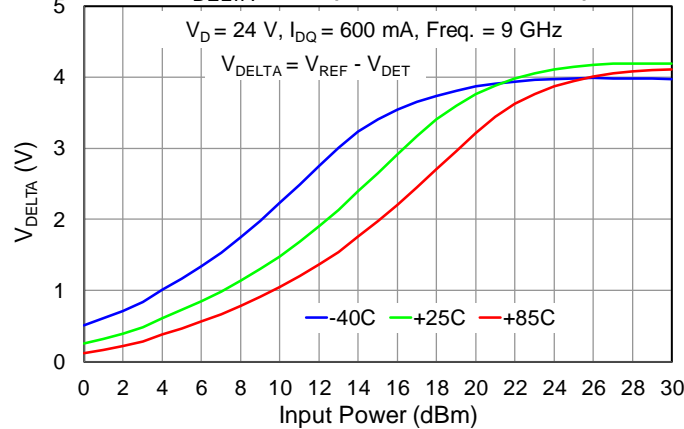

Performance Plots – Large Signal (CW)

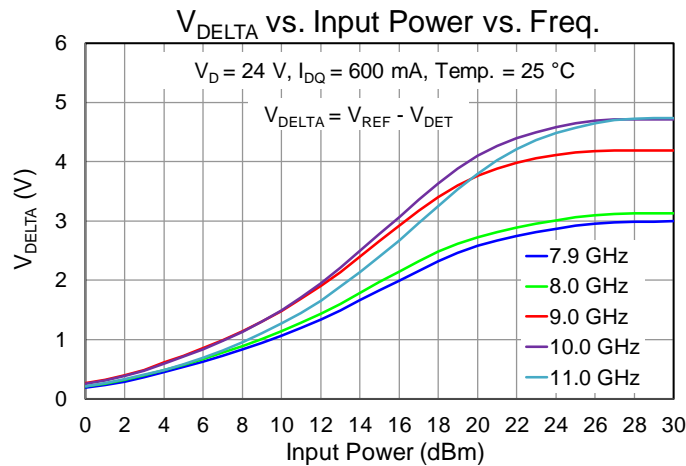
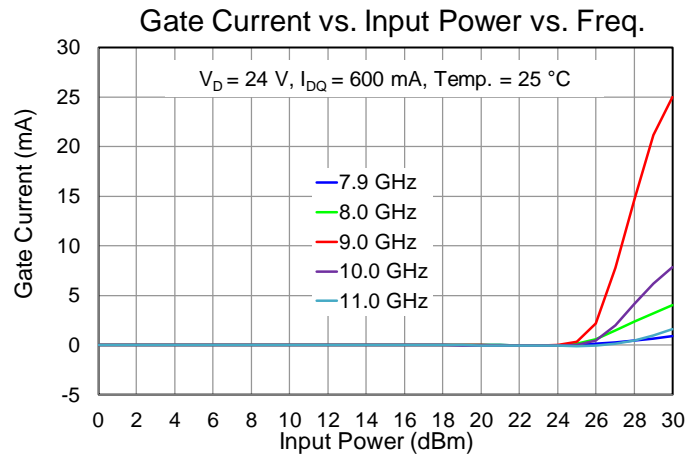
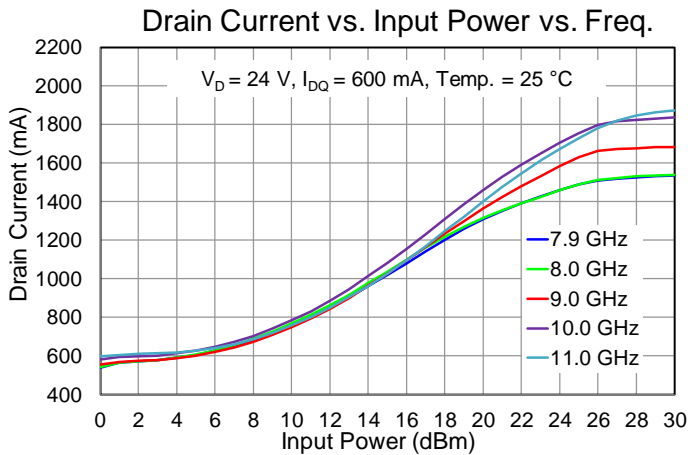
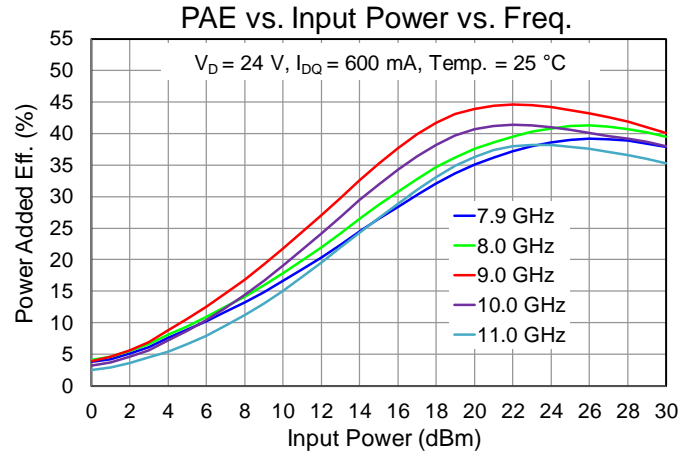
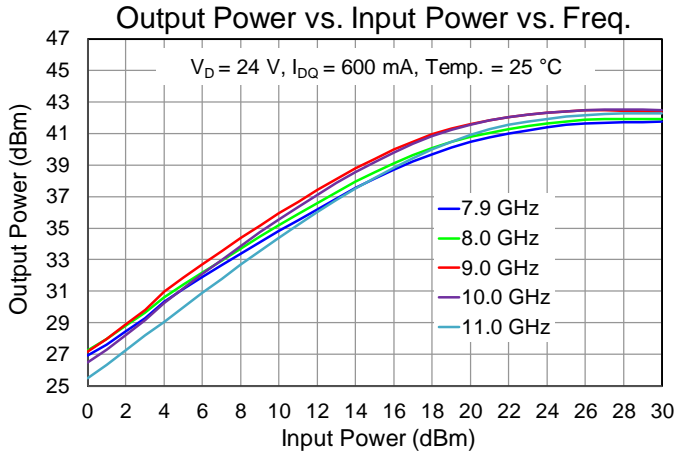

Performance Plots – Large Signal (CW)

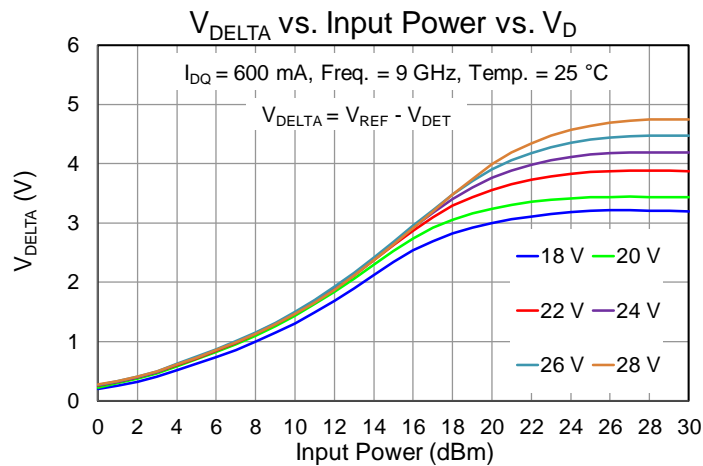
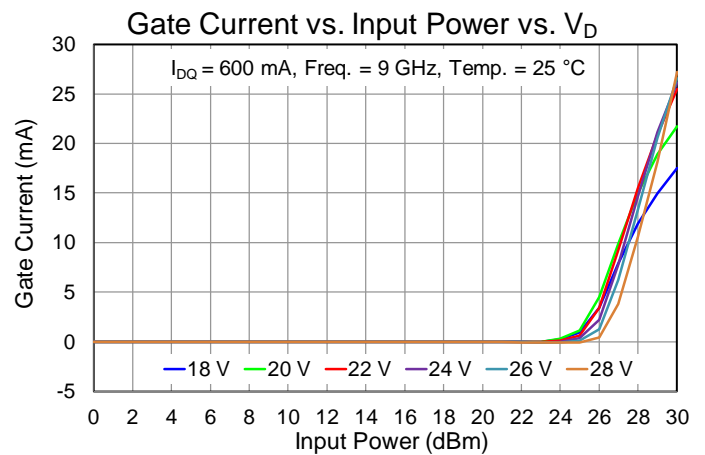
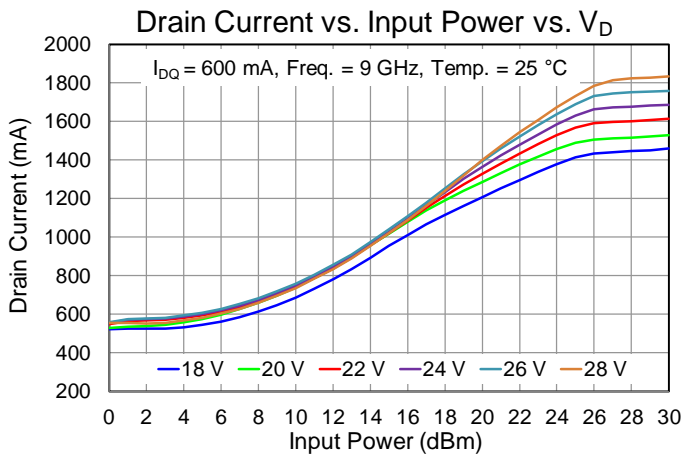
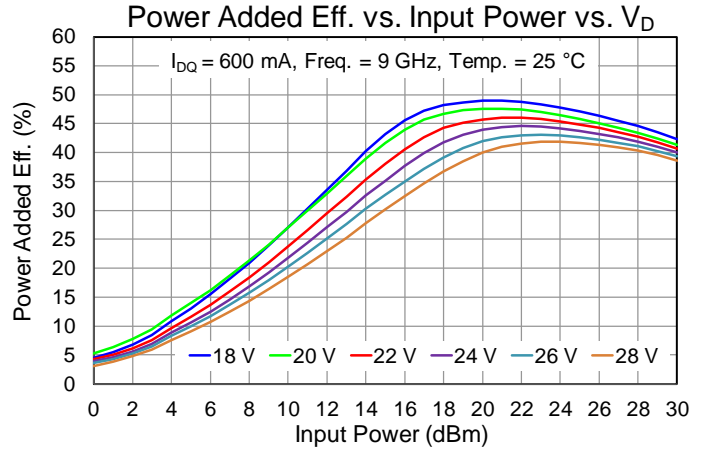
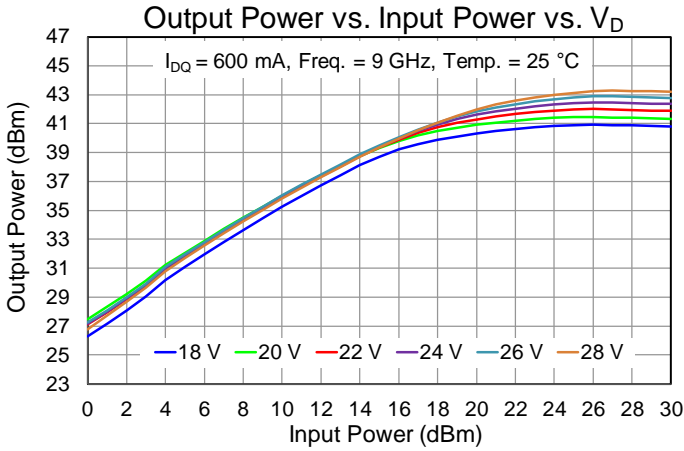

Performance Plots – Linearity

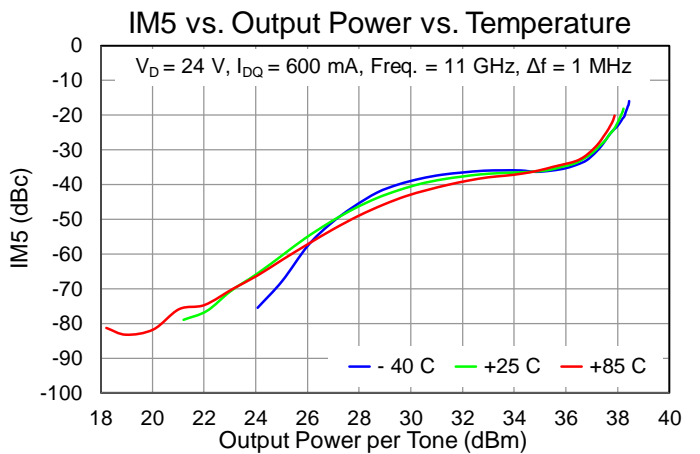
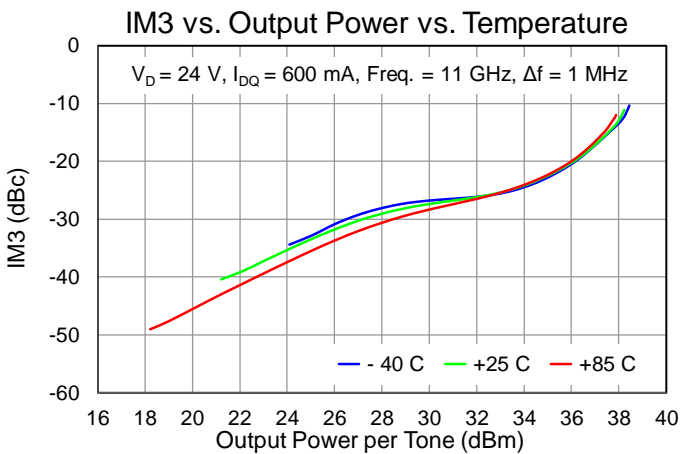
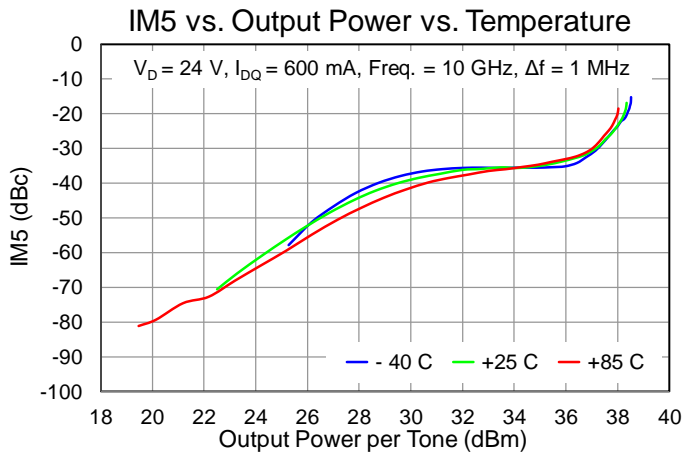
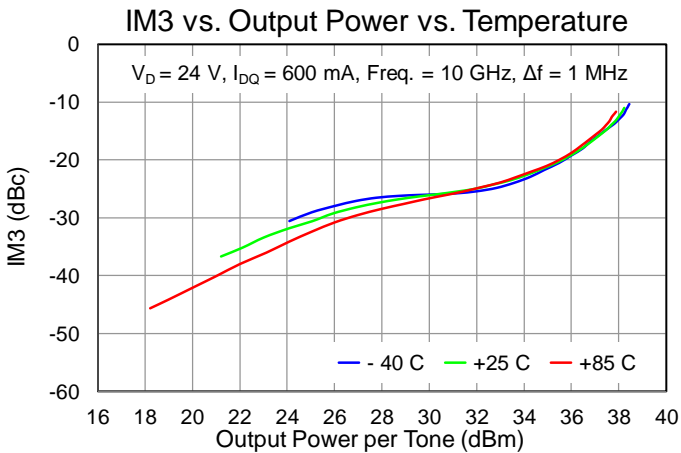
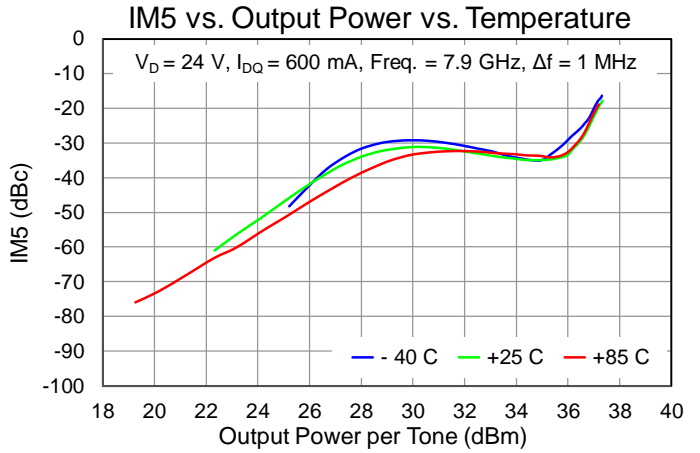
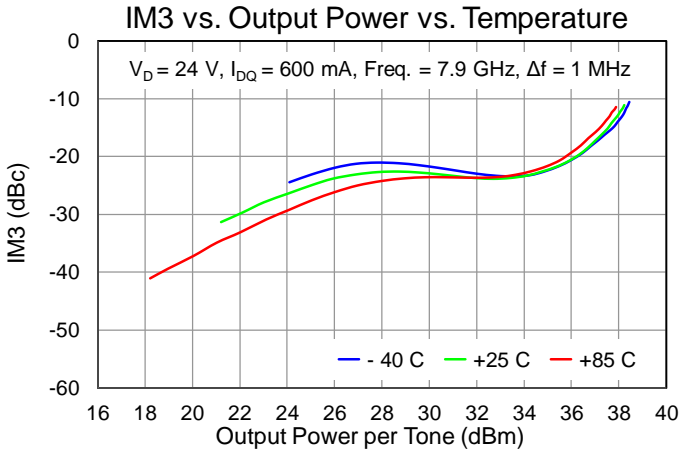

Performance Plots – Linearity

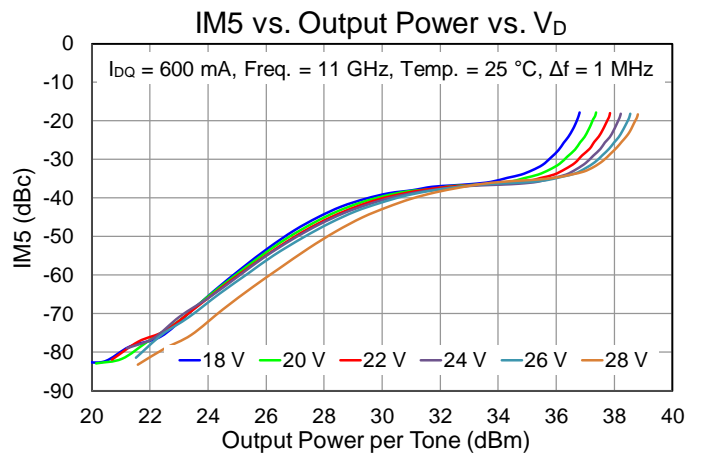
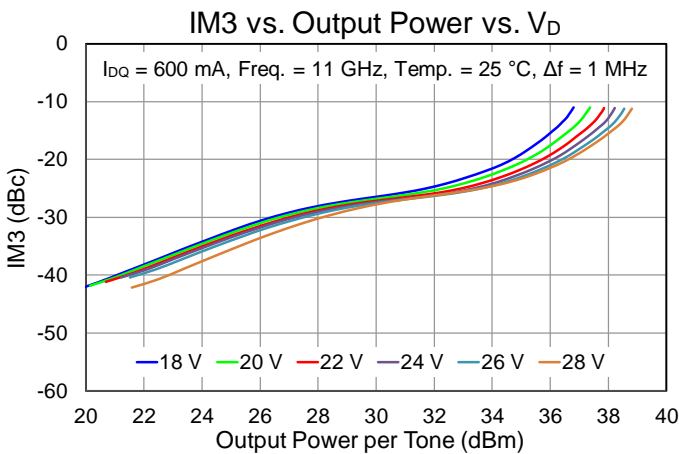
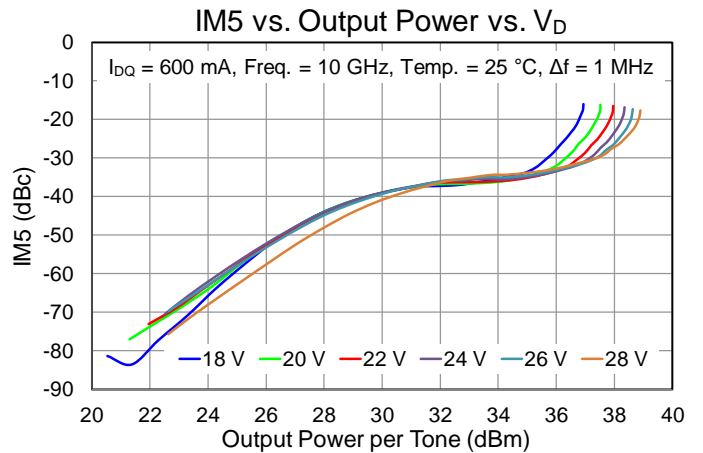
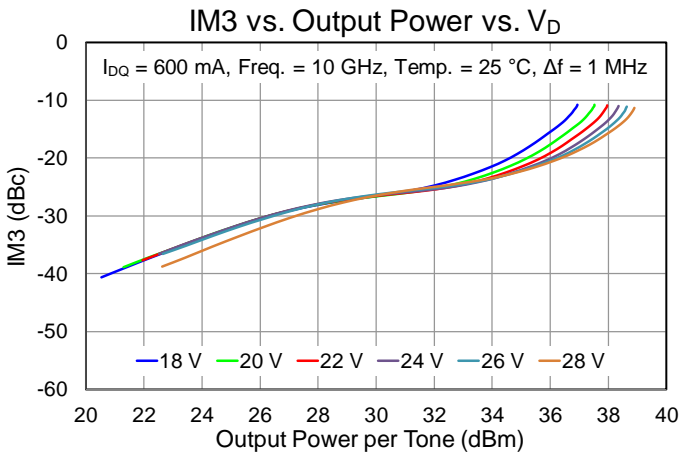
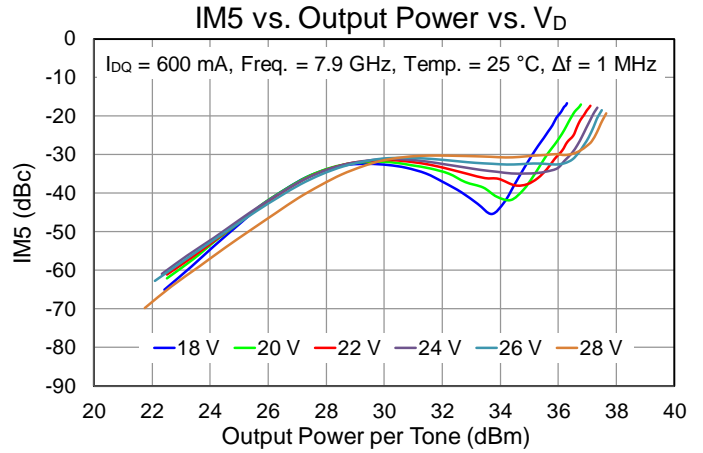
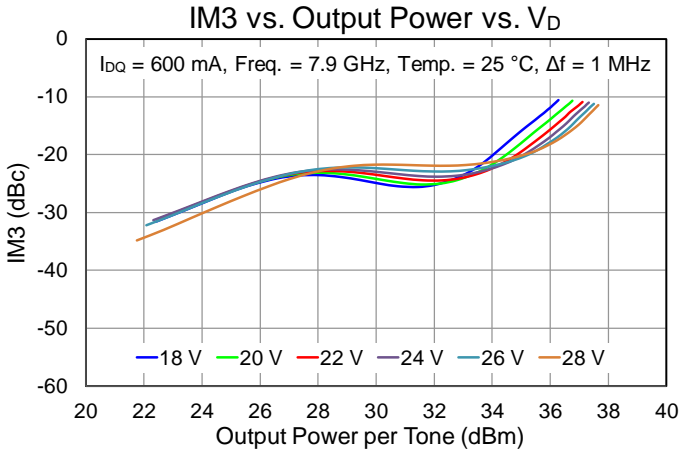

Performance Plots – Linearity

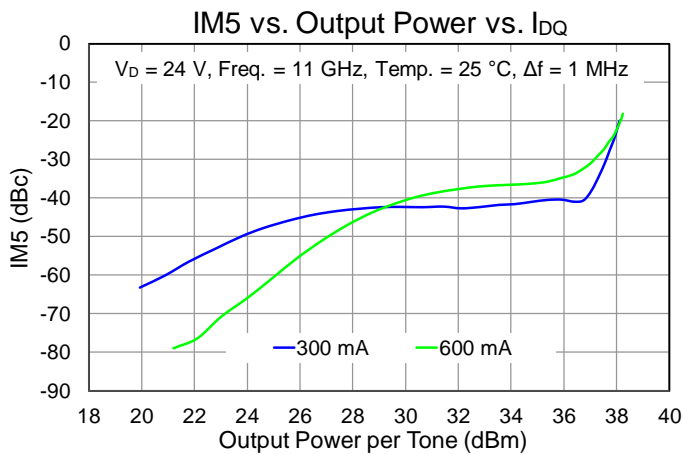
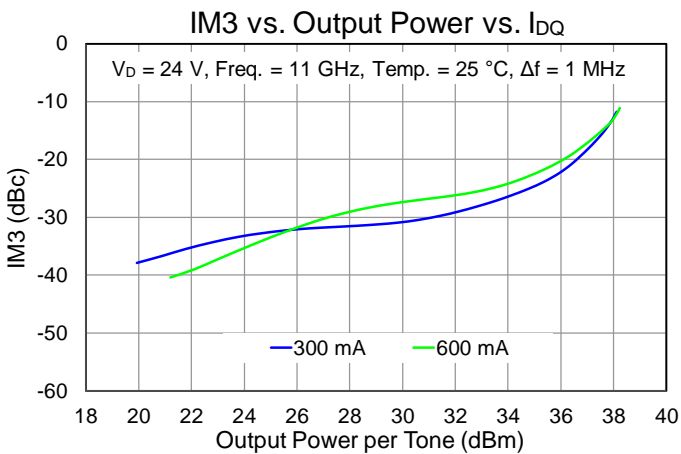
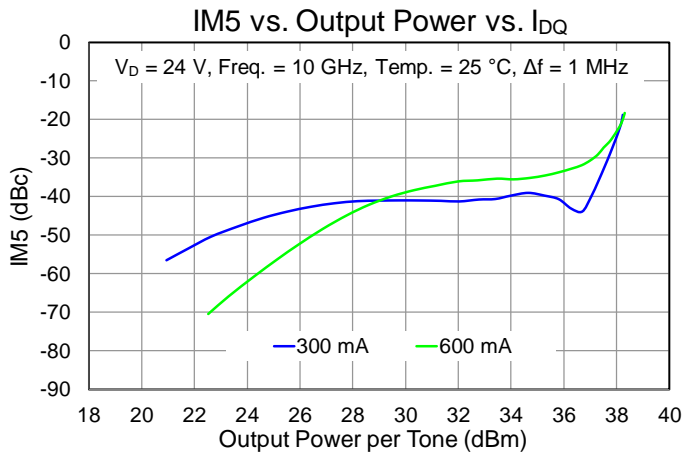
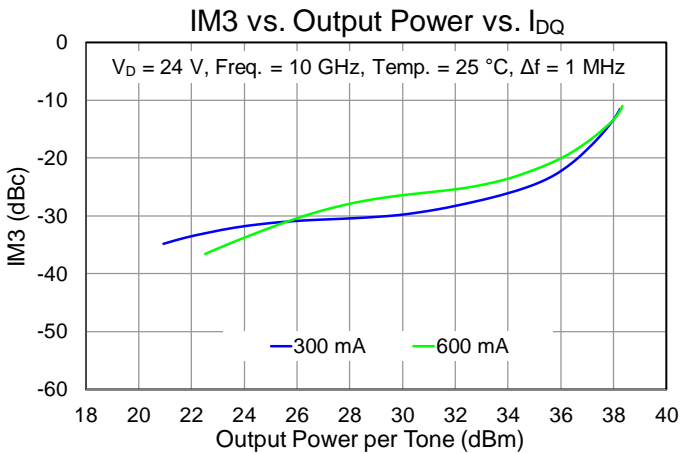
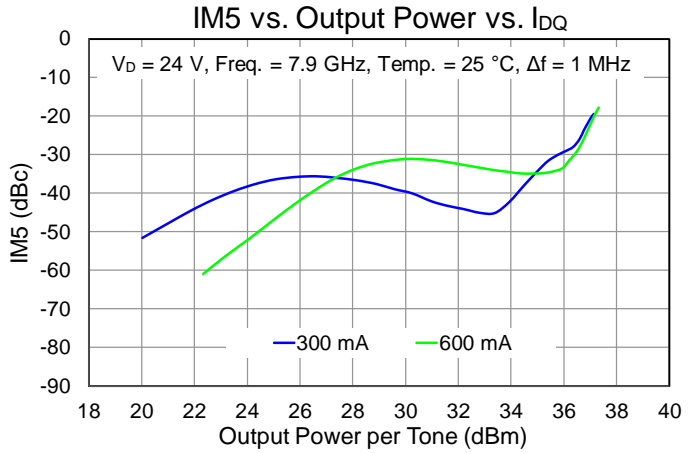
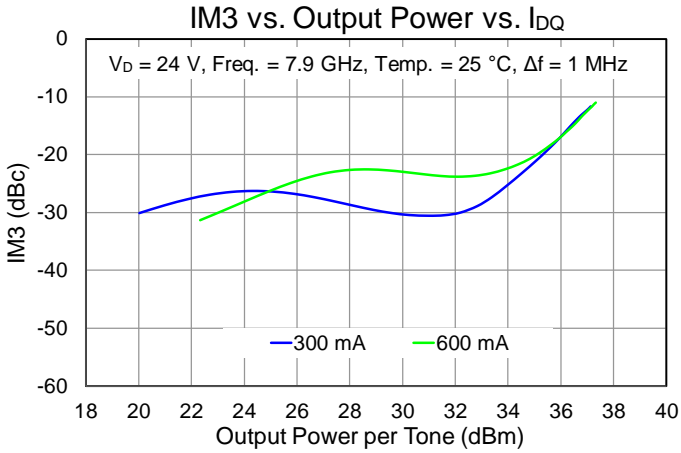

Performance Plots – Linearity

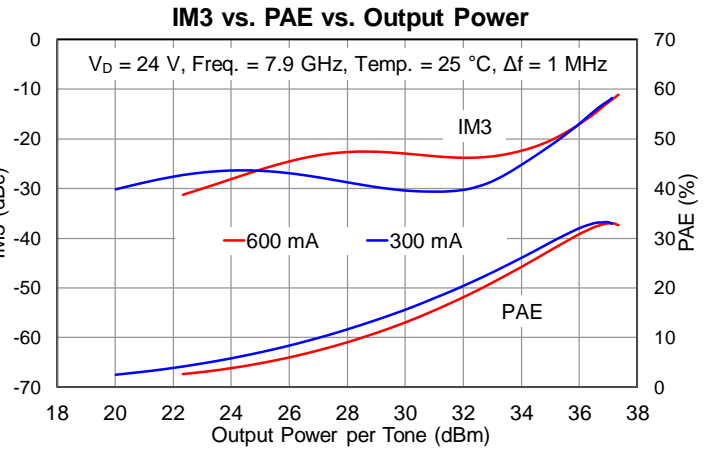
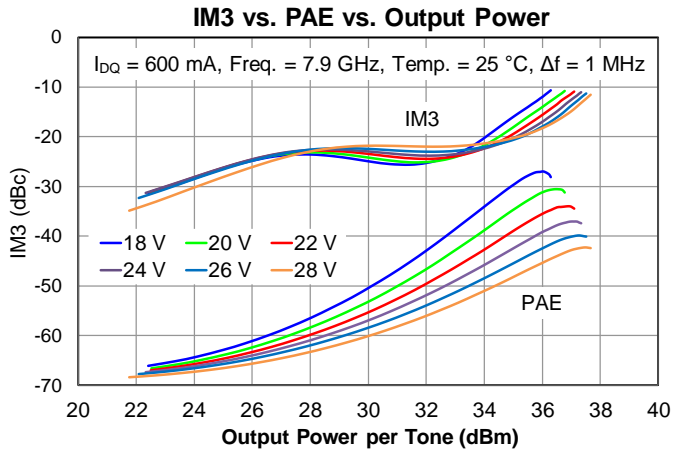

Performance Plots – Harmonics

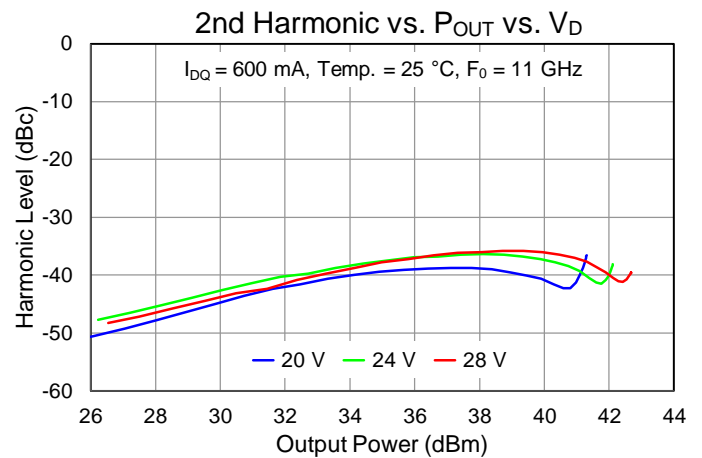
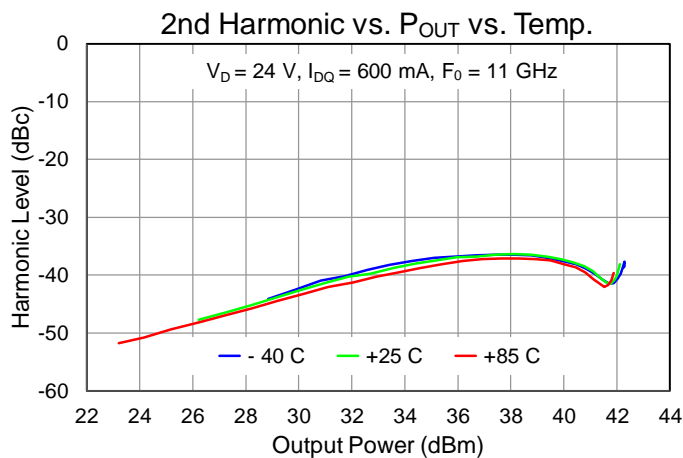
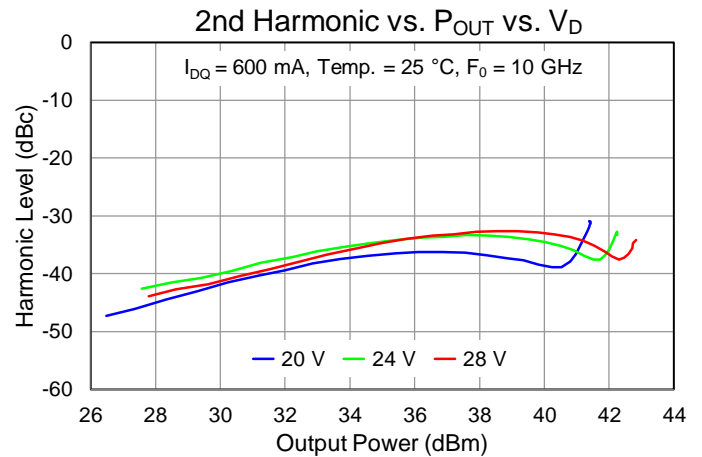
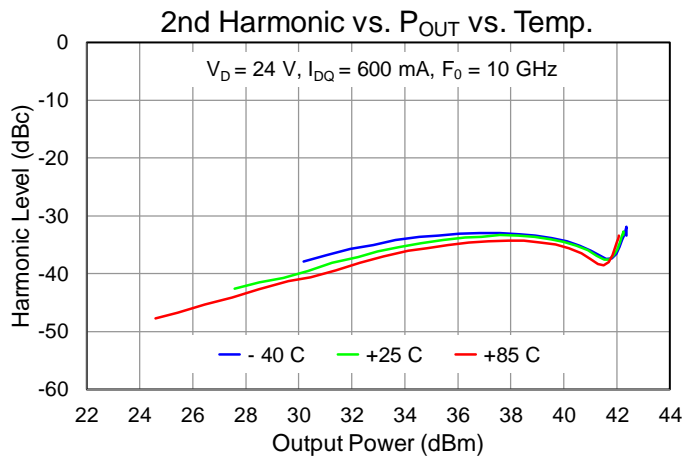
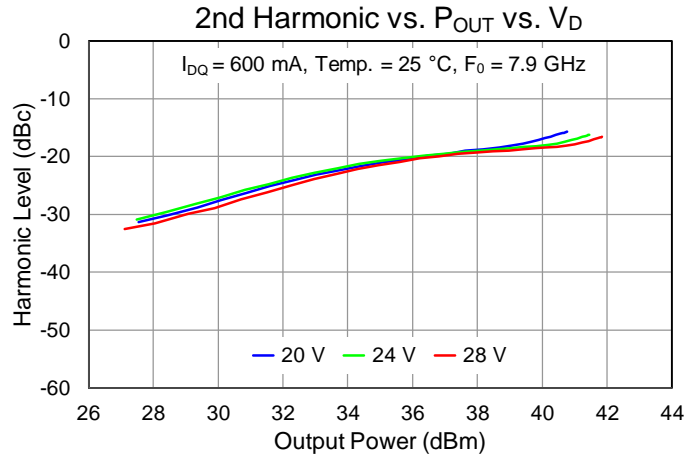
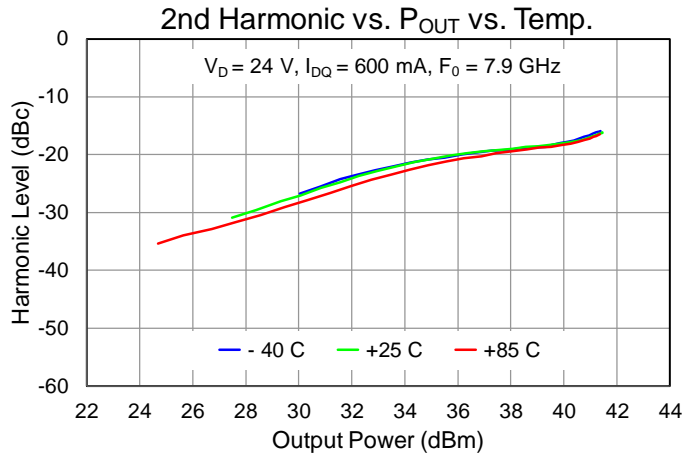

Performance Plots – Small Signal

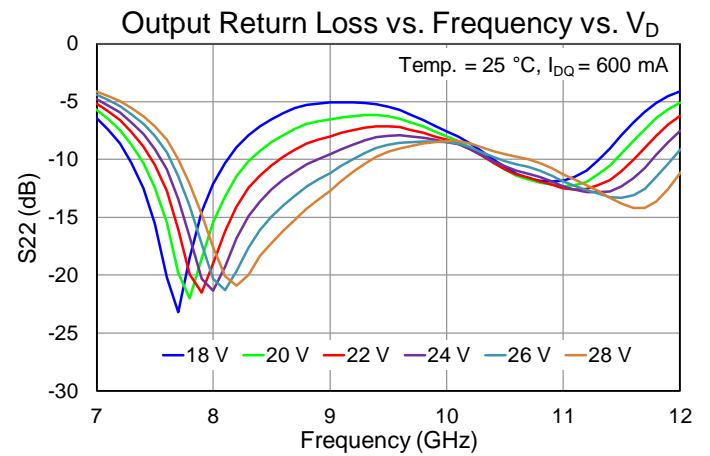
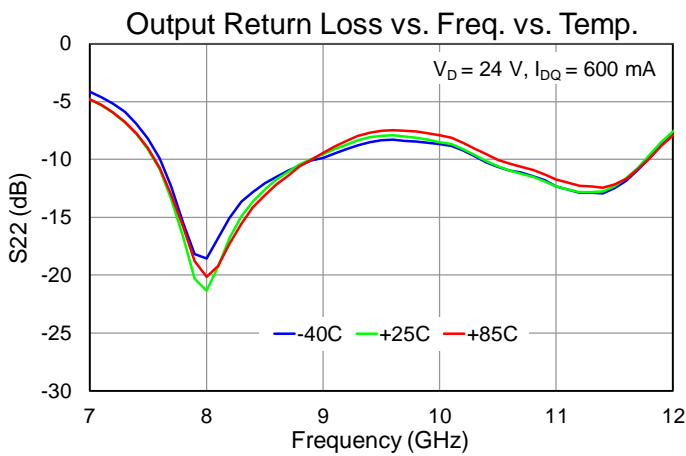
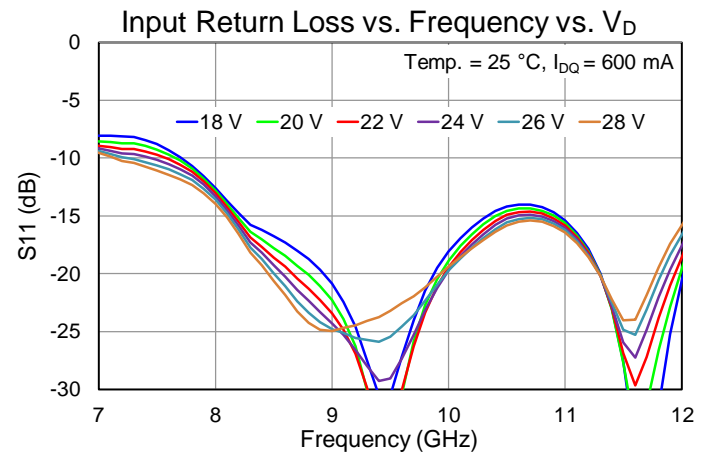
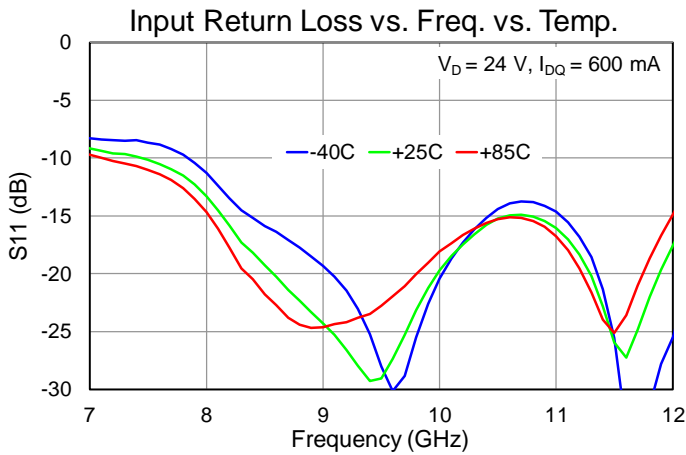
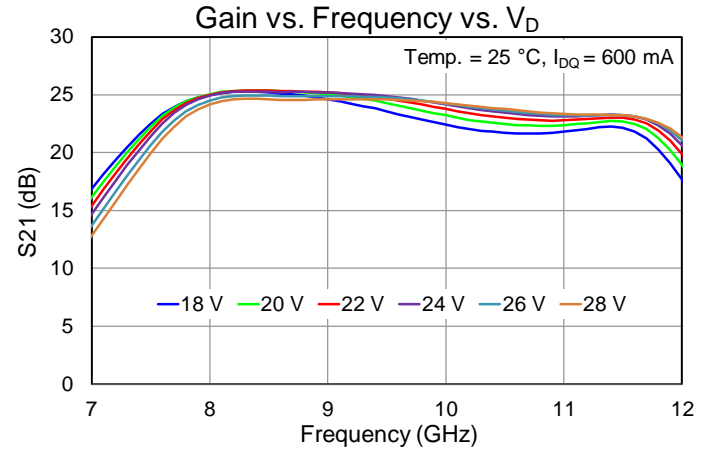
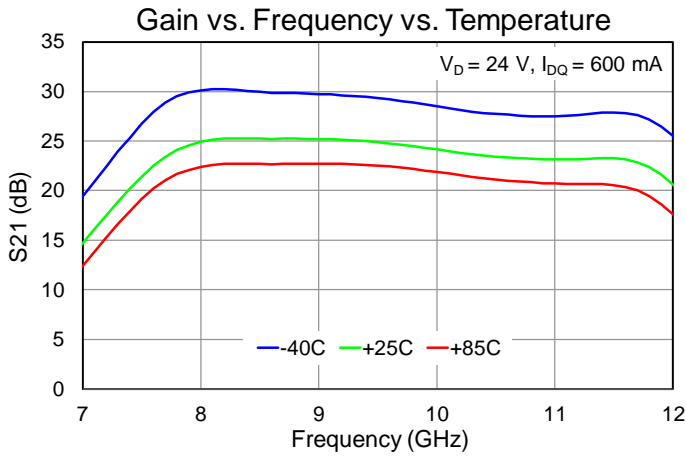

Performance Plots – Small Signal

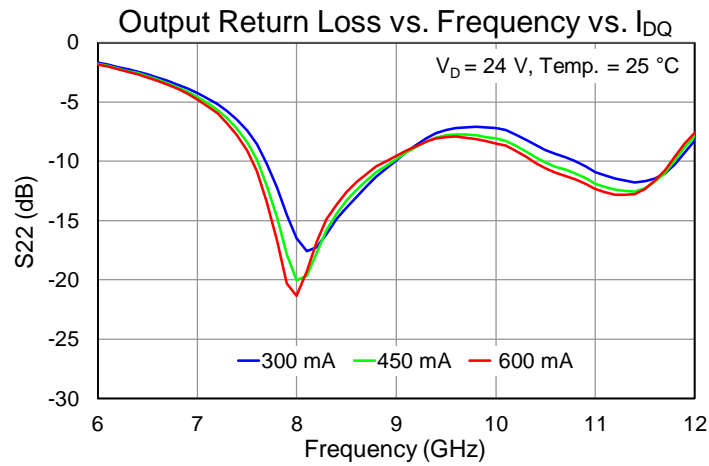
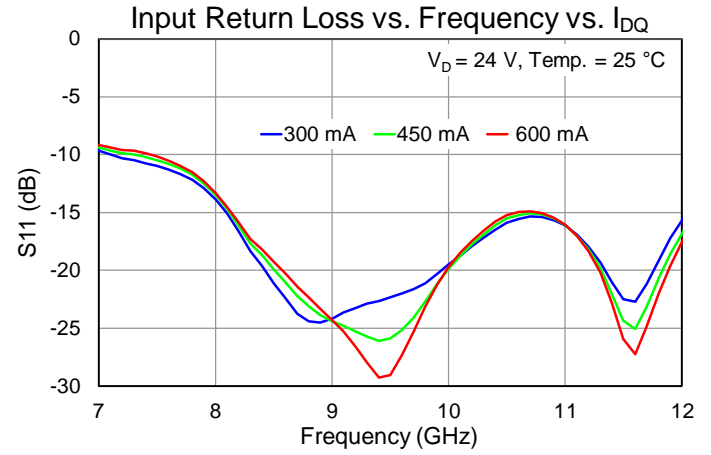
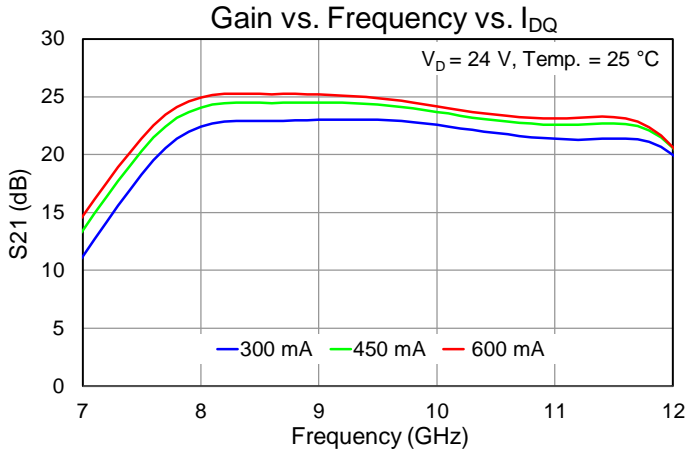

Thermal and Reliability Information

Parameter	Test Conditions	Value	Units
Thermal Resistance (θ_{JC}) ⁽¹⁾	$T_{BASE} = 85^{\circ}\text{C}$, $V_D = +24\text{V}$, $I_{DQ} = 600\text{mA}$, Pulsed V_D : $PW = 100\text{us}$; $DC = 10\%$, $Freq = 10.75\text{GHz}$, $P_{IN} = 24\text{dBm}$, $I_{D_Drive} = 1.7\text{A}$, $P_{OUT} = 41.9\text{dBm}$, $P_{DISS} = 26.4\text{W}$	2.08	$^{\circ}\text{C/W}$
Channel Temperature (T_{CH}) (Under RF drive)		140	$^{\circ}\text{C}$
Thermal Resistance (θ_{JC}) ⁽¹⁾	$T_{BASE} = 85^{\circ}\text{C}$, $V_D = +24\text{V}$, $I_{DQ} = 600\text{mA}$, CW, $P_{DISS} = 14.4\text{W}$	3.47	$^{\circ}\text{C/W}$
Channel Temperature (T_{CH}) (Quiescent, No RF)		135	$^{\circ}\text{C}$
Thermal Resistance (θ_{JC}) ⁽¹⁾	$T_{BASE} = 85^{\circ}\text{C}$, $V_D = +24\text{V}$, $I_{DQ} = 600\text{mA}$, CW, $Freq = 10.5\text{GHz}$, $P_{IN} = 24\text{dBm}$, $I_{D_Drive} = 1.6\text{A}$, $P_{OUT} = 41.5\text{dBm}$, $P_{DISS} = 23.6\text{W}$	3.35	$^{\circ}\text{C/W}$
Channel Temperature (T_{CH}) (Under RF drive)		164	$^{\circ}\text{C}$
Thermal Resistance (θ_{JC}) ⁽¹⁾	$T_{BASE} = 85^{\circ}\text{C}$, $V_D = +20\text{V}$, $I_{DQ} = 600\text{mA}$, Pulsed V_D : $PW = 100\text{us}$; $DC = 10\%$, $Freq = 10.75\text{GHz}$, $P_{IN} = 24\text{dBm}$, $I_{D_Drive} = 1.6\text{A}$, $P_{OUT} = 40.9\text{dBm}$, $P_{DISS} = 18.9\text{W}$	1.96	$^{\circ}\text{C/W}$
Channel Temperature (T_{CH}) (Under RF drive)		122	$^{\circ}\text{C}$
Thermal Resistance (θ_{JC}) ⁽¹⁾	$T_{BASE} = 85^{\circ}\text{C}$, $V_D = +20\text{V}$, $I_{DQ} = 600\text{mA}$, CW, $P_{DISS} = 12\text{W}$	3.42	$^{\circ}\text{C/W}$
Channel Temperature (T_{CH}) (Quiescent, No RF)		126	$^{\circ}\text{C}$
Thermal Resistance (θ_{JC}) ⁽¹⁾	$T_{BASE} = 85^{\circ}\text{C}$, $V_D = +20\text{V}$, $I_{DQ} = 600\text{mA}$, CW, $Freq = 10.5\text{GHz}$, $P_{IN} = 24\text{dBm}$, $I_{D_Drive} = 1.45\text{A}$, $P_{OUT} = 40.6\text{dBm}$, $P_{DISS} = 17.7\text{W}$	3.16	$^{\circ}\text{C/W}$
Channel Temperature (T_{CH}) (Under RF drive)		141	$^{\circ}\text{C}$

Notes:

1. Thermal resistance determined to the back of package (85°C)
2. Channel temperature indicated is an IR scan equivalent temperature. Thermal resistance is calculated using this value. Additional information can be found in the Qorvo Applications Note "GaN Device TCHMAX Theta-JC and Reliability Estimates," located here <https://www.qorvo.com/products/d/da006480>

Power Dissipation and Maximum Gate Current

QPA1010D I_{g_max} vs. T_{CH} vs. Stage

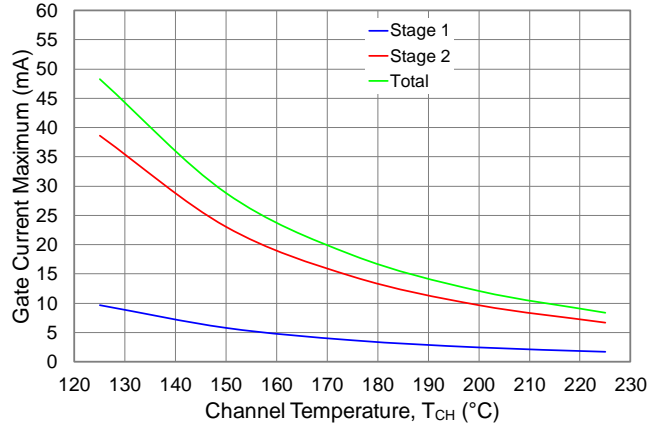

P_{DISS} vs. Frequency vs. V_D

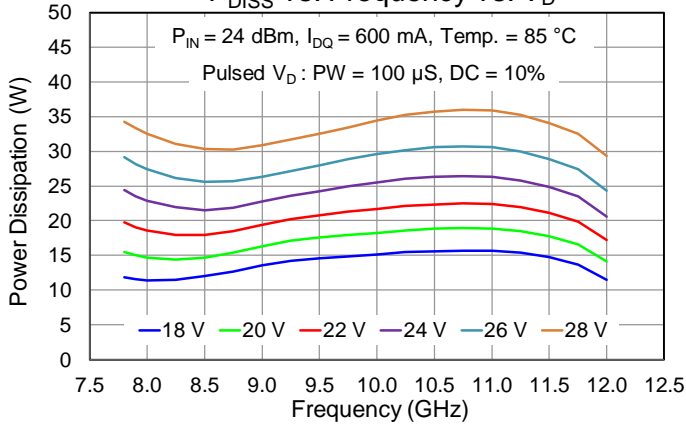

P_{DISS} vs. Frequency vs. V_D

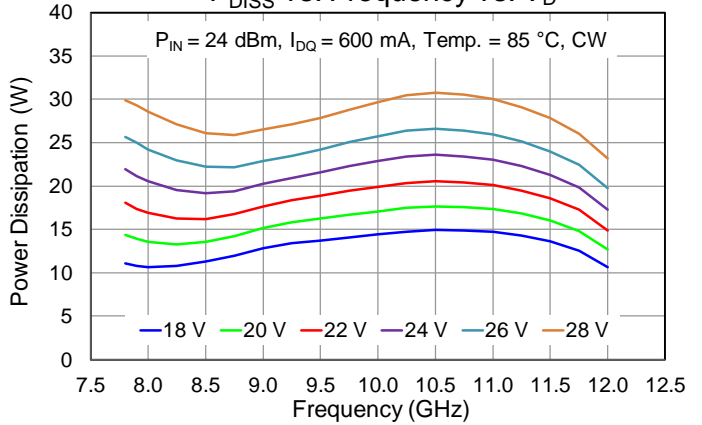

Applications Circuit for Linear and Pulsed Operations

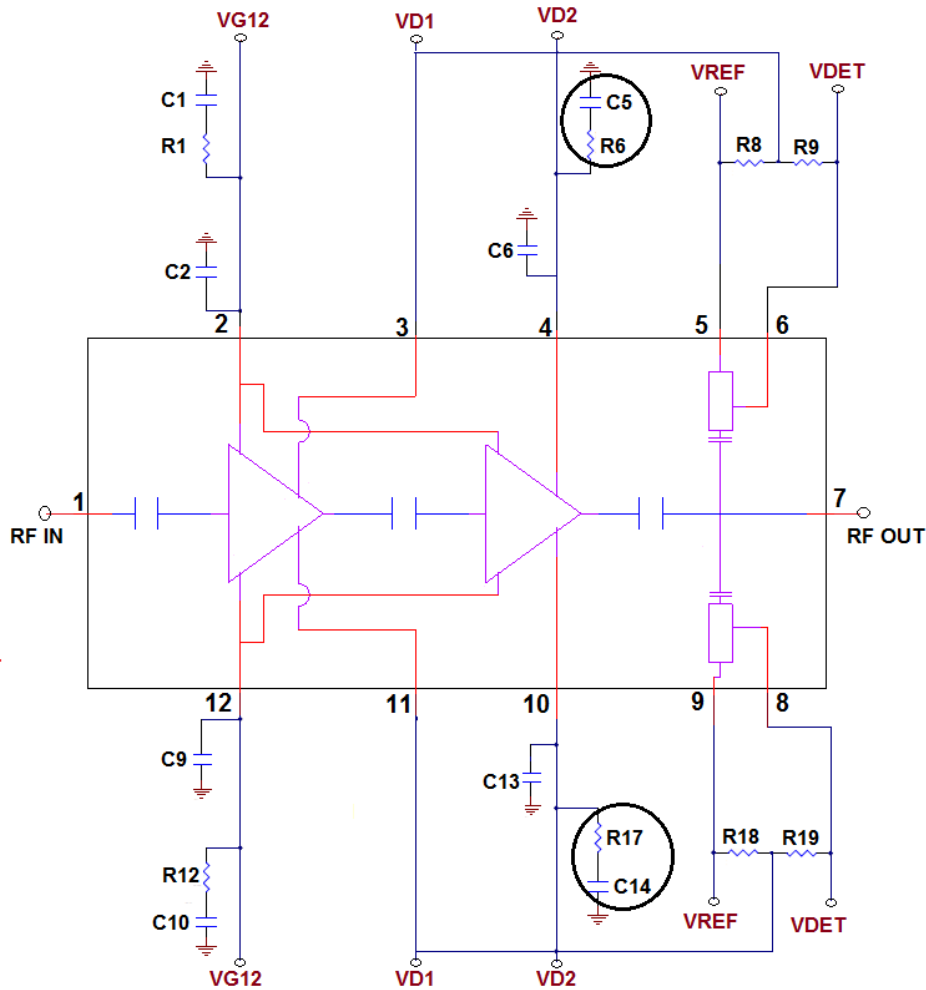

Note: $V_{\Delta} = V_{REF} - V_{DET}$

- QPA1010D can be biased from either the top side or bottom side.
- V_{D1} and V_{D2} need to be tied together.
- V_{D1} / V_{D2} and V_{REF} / V_{DET} have to be on the same side for V_{Δ} to work.
- Bypassing components required for the side(s) being biased.
- The extra bias components (R6, R17, C5 and C14) are required for optimum linearity.

Bias Up Procedure

1. Set I_D limit to 2000 mA, I_G limit to 20 mA
2. Apply -5 V to V_G
3. Apply $+24\text{ V}$ to V_D ; ensure I_{DQ} is approx. 0 mA
4. Adjust V_G until $I_{DQ} = 600\text{ mA}$ ($V_G \sim -1.9\text{ V Typ.}$).
5. Turn on RF supply

Bias Down Procedure

1. Turn off RF supply
2. Reduce V_G to -5 V ; ensure I_{DQ} is approx. 0 mA
3. Set V_D to 0 V
4. Turn off V_D supply
5. Turn off V_G supply

Evaluation Board (EVB) Layout Assembly for Pulsed Operation

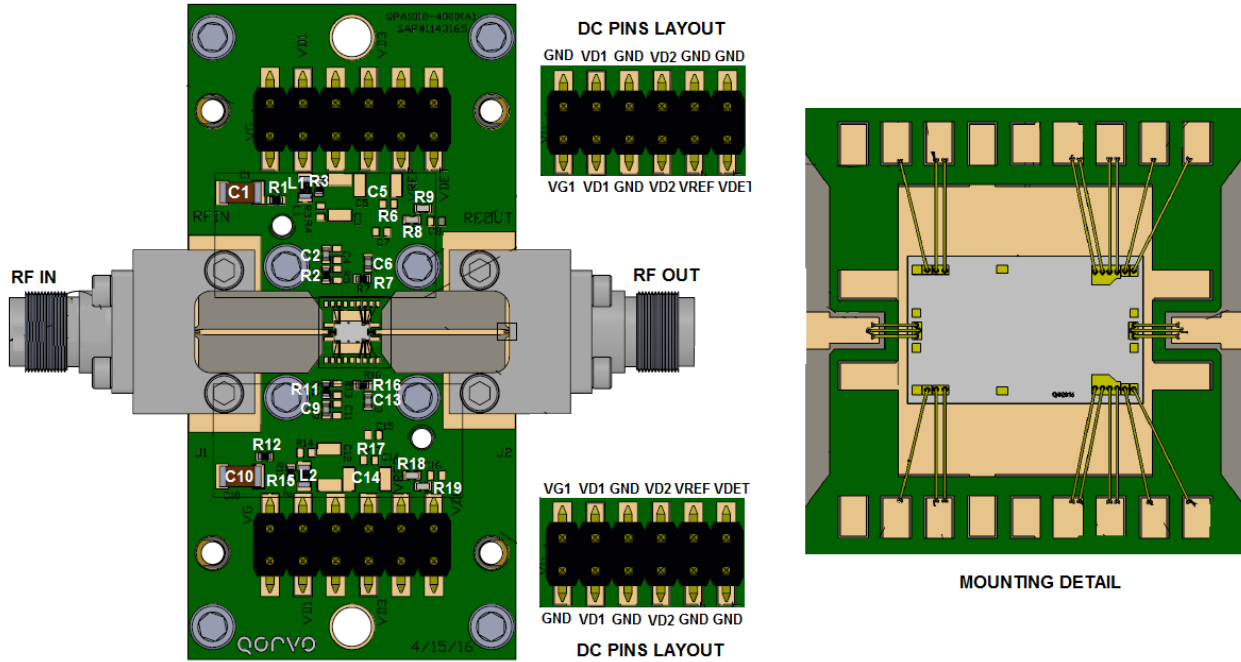

Note: PCB is a multilayer

1. All 4 metal thicknesses are 0.5 oz
2. Upper core 1 is Rogers 4003C, 8 mil thick
3. Lower core 2 is 370HR, 6 mil thick
4. Pre-Preg is an epoxy coated glass fabric
5. Total finished PCB thickness is 25 ±3 mil
6. This EVB uses a copper-coined PCB for optimum thermal management under high dissipation long pulse and/or CW conditions

Bill of Materials for EVB

Reference Des.	Value	Description	Manuf.	Part Number
C1, C5, C10, C14	10 uF	CAP, 1206, 50 V, 20 %, X5R	Various	—
C2, C6, C9, C13	0.01 uF	CAP, 0402, 50 V, 10 %, X7R	Various	—
R1, R12	5.1 Ohm	RES, 0402, 50V, 5 %, SMT	Various	—
R2, R3, R6, R7, R11, R15, R16, R17 ⁽¹⁾	0 Ohm	RES, 0402, 5 %, SMD	Various	—
R8, R9, R18, R19	25.5 K Ohm	RES, 0402, 1/16W, 1%, 0402	Various	—
L1, L2 ⁽¹⁾	0 Ohm	RES, 0603, 1/10 W	Various	—

Note:

1. These components are acting as the jumpers for this EVB.

Mechanical Information

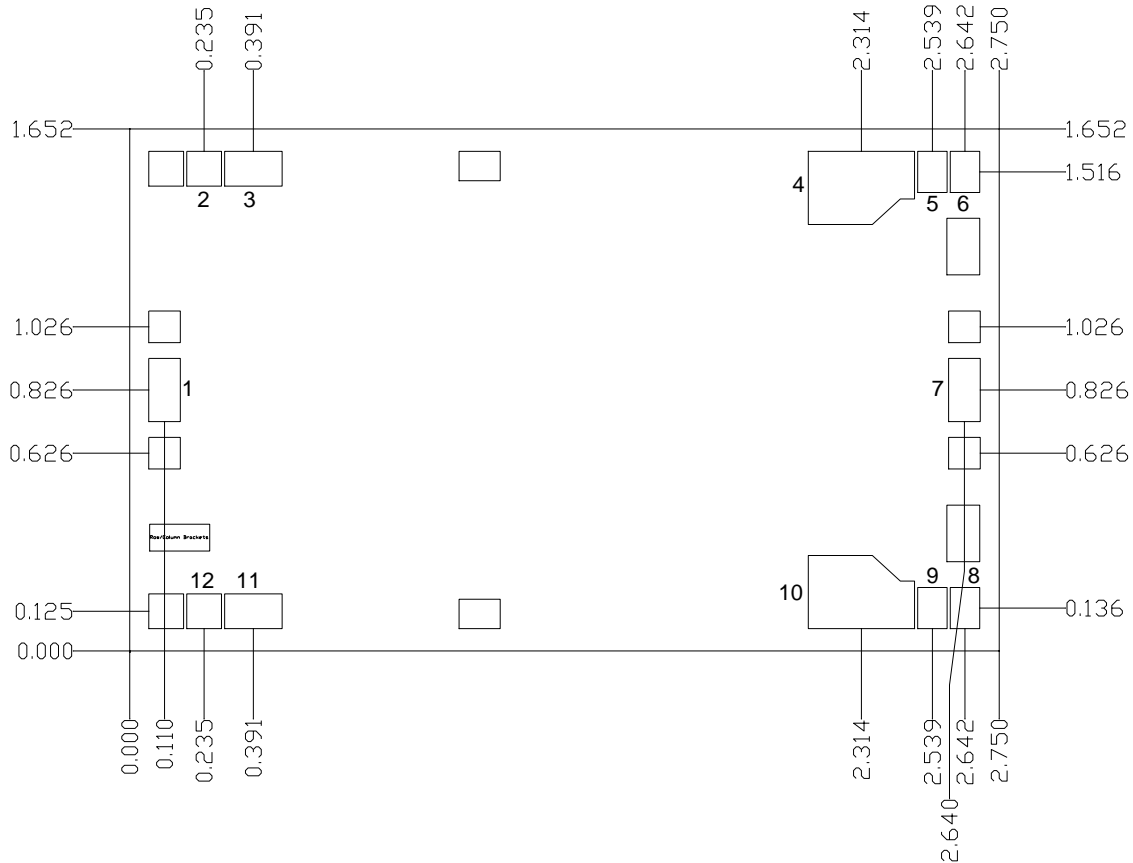

Units: millimeters
Thickness: 0.10
Die x,y size tolerance: ± 0.050
Ground is backside of die

Bond Pad Description

Pad No.	Symbol	Pad Size (mm)	Description
1	RF IN	0.100 x 0.200	RF Input; matched to 50 Ω , DC blocked
2, 12	V _{G12}	0.110 x 0.110	Gate voltage for stage 1 & 2, bias network is required; see Application Circuit on page 22 as an example.
3, 11	V _{D1}	0.182 x 0.110	Drain voltage for stage 1, bias network is required; see Application Circuit on page 22 as an example.
4, 10	V _{D2}	0.336 x 0.150	Drain voltage for stage 2, bias network is required; see Application Circuit on page 22 as an example.
5, 9	V _{REF}	0.093 x 0.130	Reference voltage for Power detector
6, 8	V _{DET}	0.093 x 0.130	Power detector voltage
7	RF OUT	0.100 x 0.200	RF Output; matched to 50 Ω , DC blocked

Assembly Notes

Component placement and adhesive attachment assembly notes:

- Vacuum pencils and/or vacuum collets are the preferred method of pick up.
- Air bridges must be avoided during placement.
- The force impact is critical during auto placement.

Reflow process assembly notes:

- Use AuSn (80/20) solder and limit exposure to temperatures above 300 °C to 3–4 minutes, maximum.
- An alloy station or conveyor furnace with reducing atmosphere should be used.
- Do not use any kind of flux.
- Coefficient of thermal expansion matching is critical for long-term reliability.
- Devices must be stored in a dry nitrogen atmosphere.

Interconnect process assembly notes:

- Thermosonic ball bonding is the preferred interconnect technique.
- Force, time, and ultrasonic are critical parameters.
- Aluminum wire should not be used.
- Devices with small pad sizes should be bonded with 0.0007-inch wire.

Handling Precautions

Parameter	Rating	Standard
ESD – Human Body Model (HBM)	TBD	ESDA / JEDEC JS-001-2012



Caution!
ESD-Sensitive Device

RoHS Compliance

This product is compliant with the 2011/65/EU RoHS directive (Restrictions on the Use of Certain Hazardous Substances in Electrical and Electronic Equipment), as amended by Directive 2015/863/EU. This product also has the following attributes:

- Lead Free
- Halogen Free (Chlorine, Bromine)
- Antimony Free
- TBBP-A (C₁₅H₁₂Br₄O₂) Free
- PFOS Free
- SVHC Free

Contact Information

For the latest specifications, additional product information, worldwide sales and distribution locations:

Tel: 1-844-890-8163

Web: www.qorvo.com

Email: customer.support@qorvo.com

Important Notice

The information contained herein is believed to be reliable; however, Qorvo makes no warranties regarding the information contained herein and assumes no responsibility or liability whatsoever for the use of the information contained herein. All information contained herein is subject to change without notice. Customers should obtain and verify the latest relevant information before placing orders for Qorvo products. The information contained herein or any use of such information does not grant, explicitly or implicitly, to any party any patent rights, licenses, or any other intellectual property rights, whether with regard to such information itself or anything described by such information. **THIS INFORMATION DOES NOT CONSTITUTE A WARRANTY WITH RESPECT TO THE PRODUCTS DESCRIBED HEREIN, AND QORVO HEREBY DISCLAIMS ANY AND ALL WARRANTIES WITH RESPECT TO SUCH PRODUCTS WHETHER EXPRESS OR IMPLIED BY LAW, COURSE OF DEALING, COURSE OF PERFORMANCE, USAGE OF TRADE OR OTHERWISE, INCLUDING THE IMPLIED WARRANTIES OF MERCHANTABILITY AND FITNESS FOR A PARTICULAR PURPOSE.**

Without limiting the generality of the foregoing, Qorvo products are not warranted or authorized for use as critical components in medical, life-saving, or life-sustaining applications, or other applications where a failure would reasonably be expected to cause severe personal injury or death.

Copyright 2019 © Qorvo, Inc. | Qorvo is a registered trademark of Qorvo, Inc.



Компания «ЭлектроПласт» предлагает заключение долгосрочных отношений при поставках импортных электронных компонентов на взаимовыгодных условиях!

Наши преимущества:

- Оперативные поставки широкого спектра электронных компонентов отечественного и импортного производства напрямую от производителей и с крупнейших мировых складов;
- Поставка более 17-ти миллионов наименований электронных компонентов;
- Поставка сложных, дефицитных, либо снятых с производства позиций;
- Оперативные сроки поставки под заказ (от 5 рабочих дней);
- Экспресс доставка в любую точку России;
- Техническая поддержка проекта, помощь в подборе аналогов, поставка прототипов;
- Система менеджмента качества сертифицирована по Международному стандарту ISO 9001;
- Лицензия ФСБ на осуществление работ с использованием сведений, составляющих государственную тайну;
- Поставка специализированных компонентов (Xilinx, Altera, Analog Devices, Intersil, Interpoint, Microsemi, Aeroflex, Peregrine, Syfer, Eurofarad, Texas Instrument, Miteq, Cobham, E2V, MA-COM, Hittite, Mini-Circuits, General Dynamics и др.);

Помимо этого, одним из направлений компании «ЭлектроПласт» является направление «Источники питания». Мы предлагаем Вам помощь Конструкторского отдела:

- Подбор оптимального решения, техническое обоснование при выборе компонента;
- Подбор аналогов;
- Консультации по применению компонента;
- Поставка образцов и прототипов;
- Техническая поддержка проекта;
- Защита от снятия компонента с производства.



Как с нами связаться

Телефон: 8 (812) 309 58 32 (многоканальный)

Факс: 8 (812) 320-02-42

Электронная почта: org@eplast1.ru

Адрес: 198099, г. Санкт-Петербург, ул. Калинина, дом 2, корпус 4, литера А.