

SERIES 96
Conductive Rubber

FEATURES

- Quality, Economical Keyboards
- Easily Customized Legends
- Matrix Circuitry
- Backlit and Shielded Options Available
- Termination Mates With Standard Connectors
- Tactile Feedback to Operator
- 1,000,000 Operations per Button
- Compatible With High Resistance Logic Inputs

The Series 96 is Grayhill's most economical 3x4 and 4x4 keypad family. The contact system utilizes conductive rubber to mate the appropriate PC board traces. Offered in matrix circuitry, with shielded and backlit options. Built with quality component parts, the Series 96 is subjected to our rigid statistical process control to insure that it meets our reliability standards.

DIMENSIONS In inches (and millimeters)

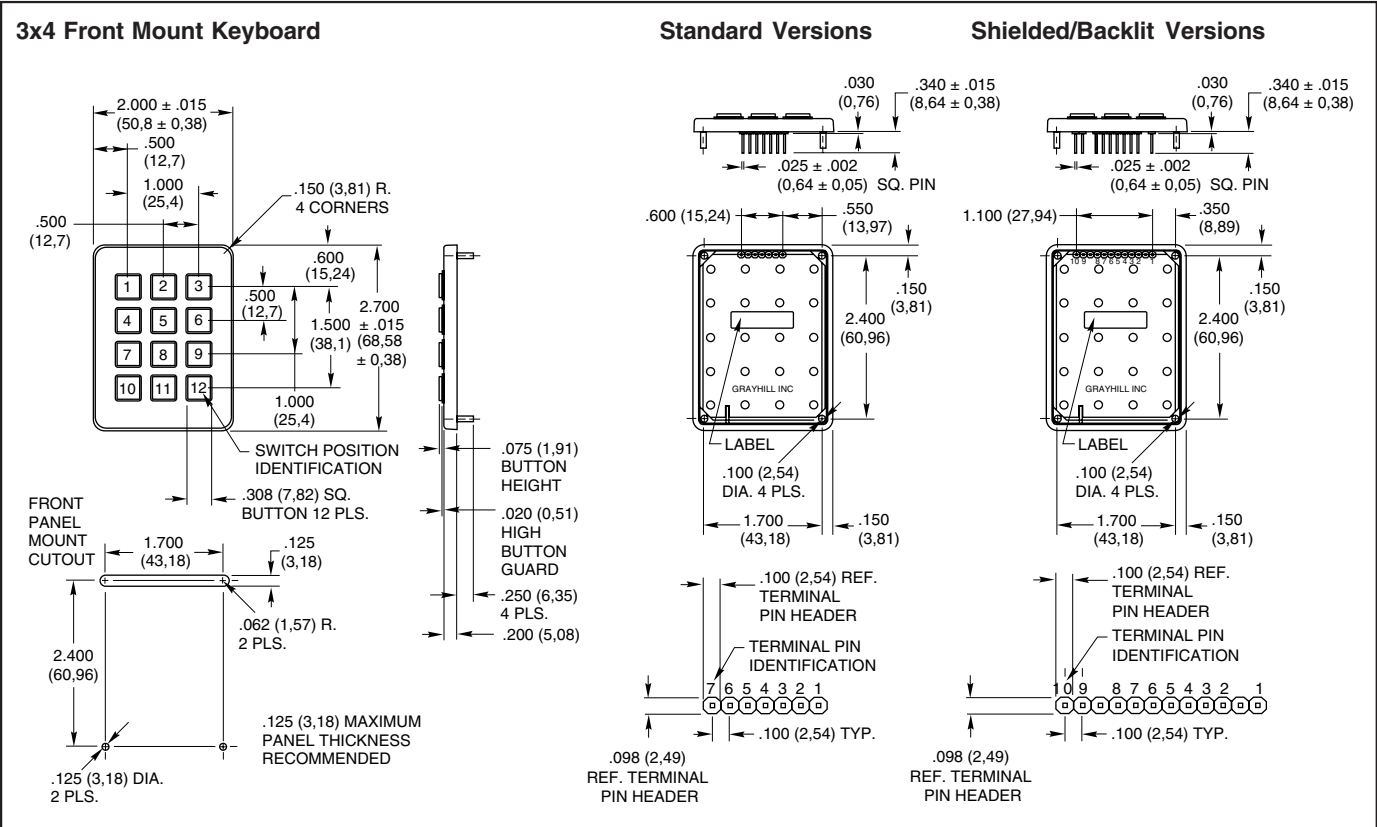

Keyboards and Keypads

DIMENSIONS In inches (and millimeters)

Keyboards and Keypads

3x4 Rear Mount Keyboard

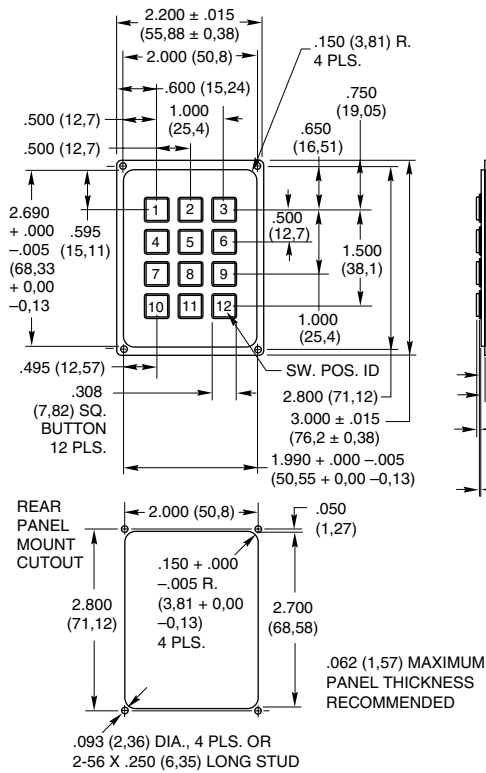

Standard Versions

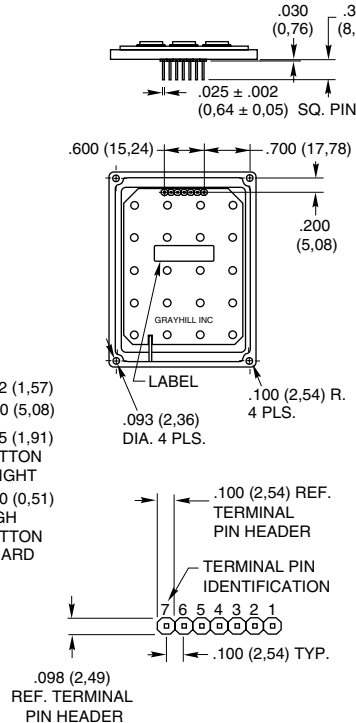

Shielded/Backlit Versions

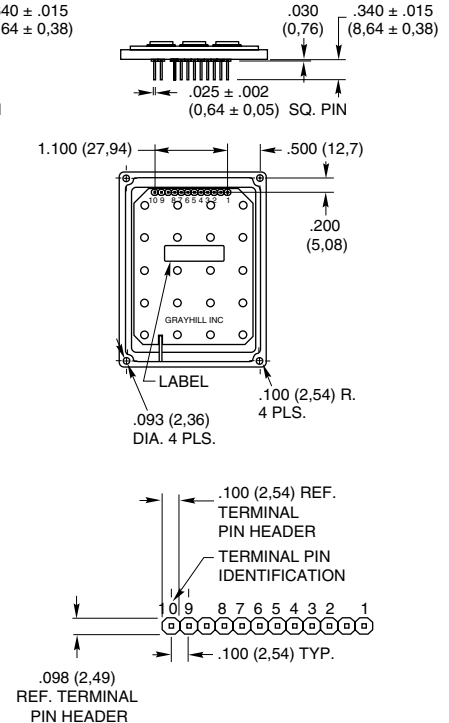

4x4 Front Mount Keyboard

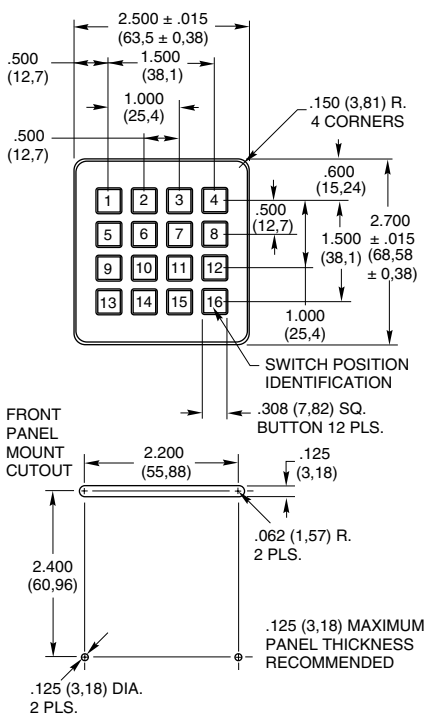

Standard Versions

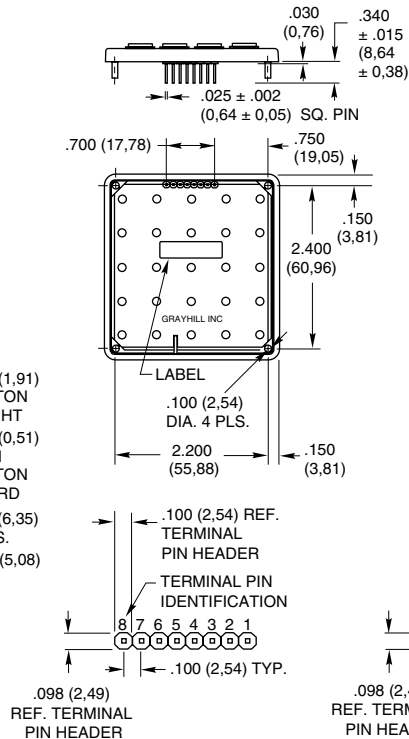

Shielded/Backlit Versions

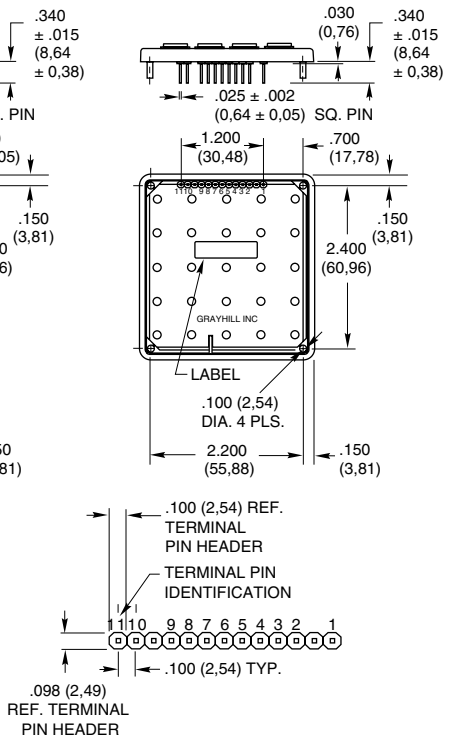

DIMENSIONS In inches (and millimeters)

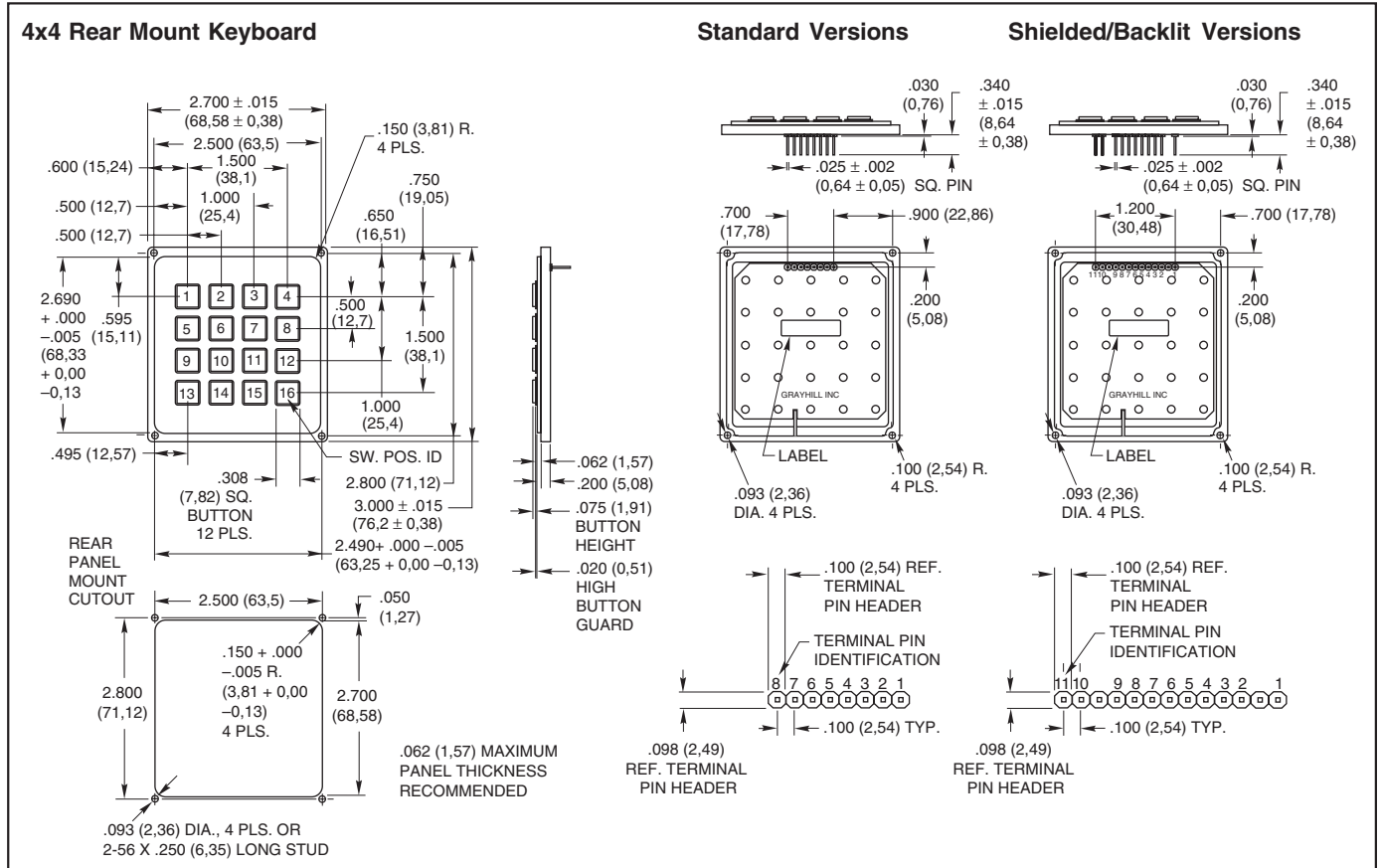

Keyboards and Keypads

CODE AND TRUTH TABLES

Dots in the chart indicate connected terminals when switch is closed. Terminals are identified on the keyboard.

12 Button Keypads

		MATRIX CODES																	
		Standard				Shielded/Backlit													
BUTTON LOCATION	1	•	•	•	•	•	•	•	•	•	•	•	•						
	2	•	•	•	•	•	•	•	•	•	•	•	•						
	3	•	•	•	•	•	•	•	•	•	•	•	•						
	4	•	•	•	•	•	•	•	•	•	•	•	•						
	5	•	•	•	•	•	•	•	•	•	•	•	•						
	6	•	•	•	•	•	•	•	•	•	•	•	•						
	7	•	•	•	•	•	•	•	•	•	•	•	•						
	8	•	•	•	•	•	•	•	•	•	•	•	•						
	9	•	•	•	•	•	•	•	•	•	•	•	•						
	10	•	•	•	•	•	•	•	•	•	•	•	•						
	11	•	•	•	•	•	•	•	•	•	•	•	•						
	12	•	•	•	•	•	•	•	•	•	•	•	•						
		5	6	7	1	2	3	4	6	7	8	2	3	4	5	1	9	10	
		TERMINAL LOCATION																	

Shielded keypad = Shielded
Backlit keypad = NC
Shielded and backlit keypad = Shielded

Shielded keypad = NC
Backlit keypad = EL Panel 1
Shielded and backlit keypad = EL Panel 1

Shielded keypad = NC
Backlit keypad = EL Panel 2
Shielded and backlit keypad = EL Panel 2

16 Button Keypads

		MATRIX CODES																			
		Standard				Shielded/Backlit															
BUTTON LOCATION	1	•	•	•	•	•	•	•	•	•	•	•	•	•	•	•					
	2	•	•	•	•	•	•	•	•	•	•	•	•	•	•	•					
	3	•	•	•	•	•	•	•	•	•	•	•	•	•	•	•					
	4	•	•	•	•	•	•	•	•	•	•	•	•	•	•	•					
	5	•	•	•	•	•	•	•	•	•	•	•	•	•	•	•					
	6	•	•	•	•	•	•	•	•	•	•	•	•	•	•	•					
	7	•	•	•	•	•	•	•	•	•	•	•	•	•	•	•					
	8	•	•	•	•	•	•	•	•	•	•	•	•	•	•	•					
	9	•	•	•	•	•	•	•	•	•	•	•	•	•	•	•					
	10	•	•	•	•	•	•	•	•	•	•	•	•	•	•	•					
	11	•	•	•	•	•	•	•	•	•	•	•	•	•	•	•					
	12	•	•	•	•	•	•	•	•	•	•	•	•	•	•	•					
	13	•	•	•	•	•	•	•	•	•	•	•	•	•	•	•					
	14	•	•	•	•	•	•	•	•	•	•	•	•	•	•	•					
	15	•	•	•	•	•	•	•	•	•	•	•	•	•	•	•					
	16	•	•	•	•	•	•	•	•	•	•	•	•	•	•	•					
		5	6	7	8	1	2	3	4	6	7	8	9	2	3	4	5	1	10	11	
		TERMINAL LOCATION																			

Shielded keypad = Shielded
Backlit keypad = NC
Shielded and backlit keypad = Shielded

Shielded keypad = NC
Backlit keypad = EL Panel 1
Shielded and backlit keypad = EL Panel 1

Shielded keypad = NC
Backlit keypad = EL Panel 2
Shielded and backlit keypad = EL Panel 2

SPECIFICATIONS

Rating Criteria

- Rating at 12 Vdc:** 5 milliamps for .5 seconds
- Contact Bounce:** < 12 milliseconds
- Contact Resistance:** < 300 milliohms max.
- Voltage Breakdown:** 250 Vac between components
- Mechanical Operation Life:** 1,000,000 operations per key
- Insulation Resistance:** > 10¹² ohms @ 500 Vdc
- Push Out Force Per Pin:** 5 lbs.

Operating Features

- Travel:** .040 minimum
- Operating Force:** 175 ± 40 grams
- Operating Temperature:** -30°C to +80°C

Material and Finishes

- Terminal Pin:** Phosphor bronze
- PC Board:** FR-4 glass cloth epoxy
- Keypad:** Silicone rubber, durometer 50 ± 5
- Housing:** ABS, cycolac FR15
- Housing Color:** Black

Shielding Effectiveness

Results shown are typical for a standard Grayhill Series 84S keyboard. A conductive gasket will generally increase the shielding, depending on the size and shape of the gasket and its material. Data derived for E-Field Radiation.

Test Method:

Measurements were made with the keyboard mounted to a brass plate, which in turn was mounted to a shielded enclosure containing the receiving equipment. A signal generator provided the frequency source that was radiated from the transmitting antenna to the enclosed receiving antenna. The spacing between antennas was maintained constant throughout the frequency range. The effectiveness rating is determined by establishing a reference reading without obstruction between the two antennas and determining the difference between that reading and the test setup reading.

Note:

When measured in actual equipment, shielding effectiveness is determined by many factors. This method accurately represents the shielding effectiveness of the Grayhill Series 84S under Ideal test conditions.

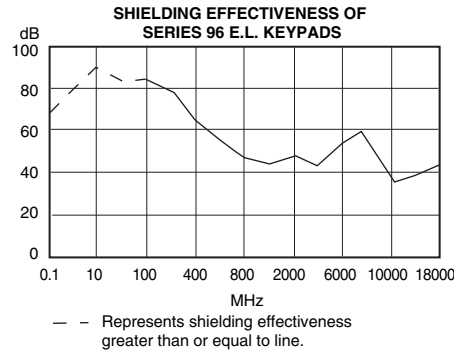

Frequency M Hz	Rating in dB
0.1	≥ 66.2
10	≥ 94.8
100	90.5
400	64.2
800	42.3
2,000	40.5
6,000	33.1
10,000	34.4
18,000	37.0

STANDARD LEGENDS

Available through Grayhill Distributors

To order one of the configurations below, use the dash number shown here; select the keypad size and code, and order the part number with the appropriate legend dash number.

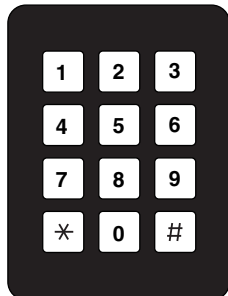

-102

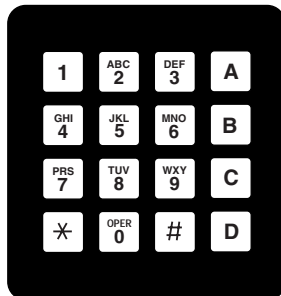

-006

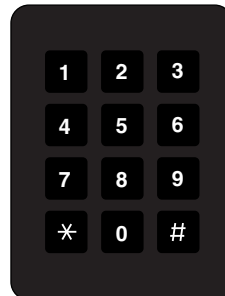

-152

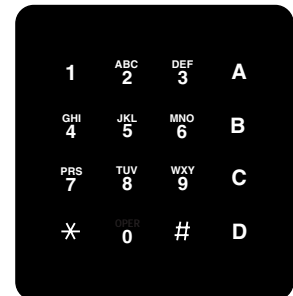

-056

ORDERING INFORMATION

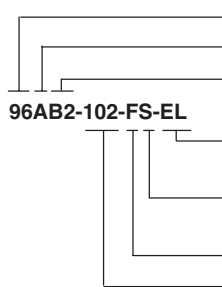

- Grayhill Series Number**
- Keyboard Size:** A = 3x4, B = 4x4
- Circuitry:** B2 = Matrix (terminal pin header)
- E.L. Panel Backlighting Option**
EL = Backlit, Blank = Non-backlit
- EMI/RFI Shielding Option**
S = Shielded, Blank = Non-shielded
- Mounting Option:** F = Front panel mount, R = Rear panel mount
- Standard Legend Choices**
- 12 Position legends*
102 = Black legends on a white button
152 = White legends on a black button
- 16 Position legends*
006 = Black legends on a white button
056 = White legends on a black button

Available from your local Grayhill Distributor.
For prices and discounts, contact a local Sales Office, an authorized local Distributor or Grayhill.



Компания «ЭлектроПласт» предлагает заключение долгосрочных отношений при поставках импортных электронных компонентов на взаимовыгодных условиях!

Наши преимущества:

- Оперативные поставки широкого спектра электронных компонентов отечественного и импортного производства напрямую от производителей и с крупнейших мировых складов;
- Поставка более 17-ти миллионов наименований электронных компонентов;
- Поставка сложных, дефицитных, либо снятых с производства позиций;
- Оперативные сроки поставки под заказ (от 5 рабочих дней);
- Экспресс доставка в любую точку России;
- Техническая поддержка проекта, помощь в подборе аналогов, поставка прототипов;
- Система менеджмента качества сертифицирована по Международному стандарту ISO 9001;
- Лицензия ФСБ на осуществление работ с использованием сведений, составляющих государственную тайну;
- Поставка специализированных компонентов (Xilinx, Altera, Analog Devices, Intersil, Interpoint, Microsemi, Aeroflex, Peregrine, Syfer, Eurofarad, Texas Instrument, Miteq, Cobham, E2V, MA-COM, Hittite, Mini-Circuits, General Dynamics и др.);

Помимо этого, одним из направлений компании «ЭлектроПласт» является направление «Источники питания». Мы предлагаем Вам помощь Конструкторского отдела:

- Подбор оптимального решения, техническое обоснование при выборе компонента;
- Подбор аналогов;
- Консультации по применению компонента;
- Поставка образцов и прототипов;
- Техническая поддержка проекта;
- Защита от снятия компонента с производства.



Как с нами связаться

Телефон: 8 (812) 309 58 32 (многоканальный)

Факс: 8 (812) 320-02-42

Электронная почта: org@eplast1.ru

Адрес: 198099, г. Санкт-Петербург, ул. Калинина, дом 2, корпус 4, литера А.