

IGBT Trench Module

$V_{CES} = 1700\text{ V}$
 $I_{C25} = 400\text{ A}$
 $V_{CE(sat)} = 2\text{ V}$

Boost/Brake Chopper + free wheeling Diode + NTC

Part number

MITA300RF1700PTED

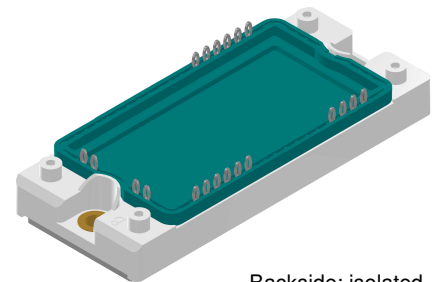

Backside: isolated

E72873

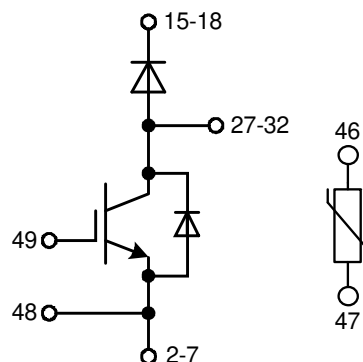

Features / Advantages:

- Brake with Infineon IGBT³

Applications:

- AC motor drives
- Solar inverter
- Medical equipment
- Uninterruptible power supply
- Air-conditioning systems
- Welding equipment
- Switched-mode and resonant-mode power supplies
- Inductive heating, cookers
- Pumps, Fans

Package: E2-Pack

- Isolation Voltage: 3600 V~
- Industry standard outline
- RoHS compliant
- PressFit-Pins for PCB mounting
- Height: 17 mm
- Base plate: Copper internally DCB isolated
- Advanced power cycling
- Phase Change Material available

Terms and Conditions of Usage

The data contained in this product data sheet is exclusively intended for technically trained staff. The user will have to evaluate the suitability of the product for the intended application and the completeness of the product data with respect to his application. The specifications of our components may not be considered as an assurance of component characteristics. The information in the valid application- and assembly notes must be considered. Should you require product information in excess of the data given in this product data sheet or which concerns the specific application of your product, please contact your local sales office.

Due to technical requirements our product may contain dangerous substances. For information on the types in question please contact your local sales office.

Should you intend to use the product in aviation, in health or life endangering or life support applications, please notify. For any such application we urgently recommend

- to perform joint risk and quality assessments;

- the conclusion of quality agreements;

- to establish joint measures of an ongoing product survey, and that we may make delivery dependent on the realization of any such measures.

Free Wheeling Diode FWD				Ratings			
Symbol	Definition	Conditions	min.	typ.	max.	Unit	
V_{RSM}	max. non-repetitive reverse blocking voltage				1700	V	
V_{RRM}	max. repetitive reverse blocking voltage				1700	V	
I_R	reverse current, drain current	$V_R = 1700\text{ V}$			100	μA	
	* not applicable, see Ices at IGBT	$V_R = 1700\text{ V}$			0.8	mA	
V_F	forward voltage drop	$I_F = 40\text{ A}$			2.20	V	
		$I_F = 80\text{ A}$			2.75	V	
		$I_F = 40\text{ A}$	$T_{VJ} = 125^\circ\text{C}$			2.30	V
		$I_F = 80\text{ A}$	$T_{VJ} = 125^\circ\text{C}$			3.15	V
I_{FAV}	average forward current	$T_C = 80^\circ\text{C}$ rectangular $d = 0.5$			40	A	
V_{F0}	threshold voltage	} for power loss calculation only			1.35	V	
r_F	slope resistance				23	m Ω	
R_{thJC}	thermal resistance junction to case				1	K/W	
R_{thCH}	thermal resistance case to heatsink			0.30		K/W	
P_{tot}	total power dissipation				125	W	
I_{FSM}	max. forward surge current	$t = 10\text{ ms}; (50\text{ Hz}), \text{ sine}; V_R = 0\text{ V}$			300	A	
C_J	junction capacitance	$V_R = 900\text{ V}$ $f = 1\text{ MHz}$			14	pF	

Boost IGBT				Ratings			
Symbol	Definition	Conditions	min.	typ.	max.	Unit	
V_{CES}	collector emitter voltage				1700	V	
V_{GES}	max. DC gate voltage				±20	V	
V_{GEM}	max. transient gate emitter voltage				±30	V	
I_{C25}	collector current				400	A	
I_{C80}					280	A	
P_{tot}	total power dissipation				1390	W	
$V_{CE(sat)}$	collector emitter saturation voltage	$I_C = 300A; V_{GE} = 15V$			2	V	
					2.4	V	
$V_{GE(th)}$	gate emitter threshold voltage	$I_C = 12mA; V_{GE} = V_{CE}$	5.2	5.8	6.4	V	
I_{CES}	collector emitter leakage current	$V_{CE} = V_{CES}; V_{GE} = 0V$			1.2	mA	
					1.4	mA	
I_{GES}	gate emitter leakage current	$V_{GE} = ±20V$			800	nA	
$Q_{G(on)}$	total gate charge	$V_{CE} = 900V; V_{GE} = 15V; I_C = 300A$		3400		nC	
$t_{d(on)}$	turn-on delay time	inductive load $V_{CE} = 900V; I_C = 300A$ $V_{GE} = ±15V; R_G = 4.7Ω$		340		ns	
t_r	current rise time			90		ns	
$t_{d(off)}$	turn-off delay time			800		ns	
t_f	current fall time			400		ns	
E_{on}	turn-on energy per pulse			100		mJ	
E_{off}	turn-off energy per pulse			75		mJ	
RBSOA	reverse bias safe operating area	$V_{GE} = ±15V; R_G = 4.7Ω$					
I_{CM}		$V_{CEmax} = 1700V$			600	A	
SCSOA	short circuit safe operating area	$V_{CEmax} = 1700V$					
t_{SC}	short circuit duration	$V_{CE} = 900V; V_{GE} = ±15V$			10	μs	
I_{SC}	short circuit current	$R_G = 4.7Ω; \text{non-repetitive}$		1600		A	
R_{thJC}	thermal resistance junction to case				0.09	K/W	
R_{thCH}	thermal resistance case to heatsink				0.03	K/W	
Boost Diode BD							
V_{RRM}	max. repetitive reverse voltage				1700	V	
I_{F25}	forward current				400	A	
I_{F80}					300	A	
V_F	forward voltage	$I_F = 300A$			2.20	V	
					2.00	V	
I_R	reverse current	$V_R = V_{RRM}$			1.2	mA	
					1.2	mA	
Q_{rr}	reverse recovery charge	$V_R = 900V$ $-di_F/dt = 3000A/μs$ $I_F = 300A; V_{GE} = 0V$		80		μC	
I_{RM}	max. reverse recovery current			300		A	
t_{rr}	reverse recovery time			950		ns	
E_{rec}	reverse recovery energy			40		mJ	
R_{thJC}	thermal resistance junction to case				0.14	K/W	
R_{thCH}	thermal resistance case to heatsink				0.05	K/W	

Package E2-Pack		Ratings				
Symbol	Definition	Conditions	min.	typ.	max.	Unit
I_{RMS}	RMS current	per terminal			30	A
T_{VJ}	virtual junction temperature		-40		150	°C
T_{op}	operation temperature		-40		125	°C
T_{stg}	storage temperature		-40		125	°C
Weight				176		g
M_D	mounting torque		3		6	Nm
$d_{Spp/App}$	creepage distance on surface / striking distance through air	terminal to terminal	6.0			mm
$d_{Spb/Apb}$		terminal to backside	12.0			mm
V_{ISOL}	isolation voltage	t = 1 second	3600			V
		t = 1 minute	3000			V
$R_{pin-chip}$	resistance pin to chip	$V = V_{CEsat} + 2 \cdot R \cdot I_C$ resp. $V = V_F + 2 \cdot R \cdot I_F$		2.5		mΩ

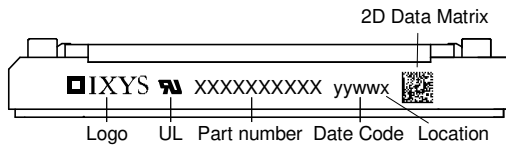

Part description

- M = Module
- I = IGBT
- T = IGBT Trench
- A = Gen 3 / std
- 300 = Current Rating [A]
- RF = Boost/Brake Chopper + free wheeling Diode
- 1700 = Reverse Voltage [V]
- PT = PressFit-Pin, Thermistor
- ED = E2-Pack
- = Hyphen
- PC = Phase Change Material

Ordering	Ordering Number	Marking on Product	Delivery Mode	Quantity	Code No.
Standard	MITA300RF1700PTED	MITA300RF1700PTED	Blister	28	516670
Alternative	MITA300RF1700PTED-PC	MITA300RF1700PTED	Blister	28	515402

Temperature Sensor NTC

Symbol	Definition	Conditions	min.	typ.	max.	Unit
R_{25}	resistance	$T_{VJ} = 25^\circ$	4.85	5	5.15	kΩ
$B_{25/50}$	temperature coefficient			3375		K

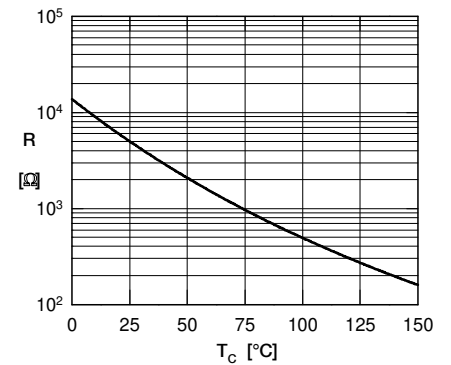

Outlines E2-Pack

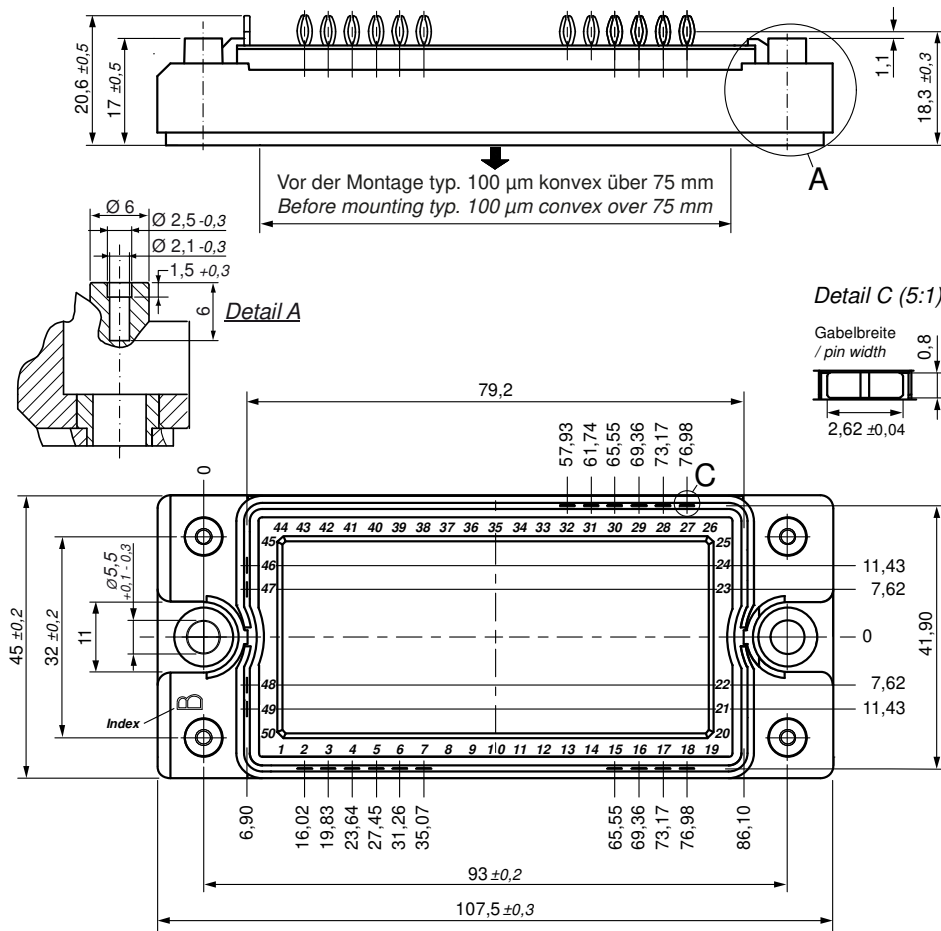

Bemerkung / Note:

- Nicht tolerierte Maße nach / Measure without tolerances according DIN ISO 2768-T1-m
- PCB-Lochmuster / PCB hole pattern: **see pin position**
- Toleranz Pin-Position und PCB-Lochmuster / Tolerance of pin position and PCB hole pattern: $\oplus 0.1$
- Bohrlochdurchmesser / Diameter of drill: $\varnothing 2.35$ mm
- Endlochdurchmesser / Diameter of plated holes: $\varnothing 2.14 - 2.29$ mm (Cu thickness in via typ. 50 µm)
- Beschichtung / Plating: **chem. Sn max. 15 µm**
- Einpresskraft / Insert Force: per terminal with a typ. insert speed of 7 mm/s: **typ. 90 N**
- Weitere Angaben / Further information: www.ixys.com **Application note IXAN0077**
- Montageanleitung / Mounting instruction: www.ixys.com **Application note IXAN0024**

Detail A: PCB-Montage / Mounting on PCB^L

- Empfohlene, selbstschneidende Schraube / Recommended, self-tapping screw: **EJOT PT®** (Größe / size: **K25**)^L
- Max. Schraubenlänge / Max. screw length: **PCB-Dicke / thickness + 6 mm** (max. Lochtiefe / hole depth)^L
- Empfohlenes Drehmoment / Recommended mounting torque: **1.5 Nm**

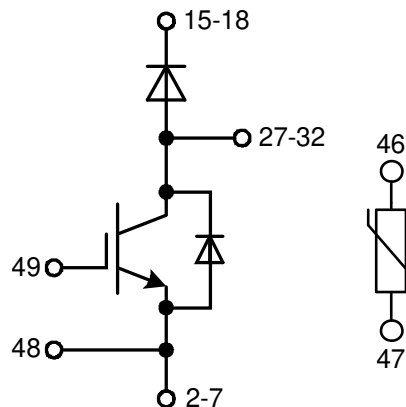

Boost IGBT

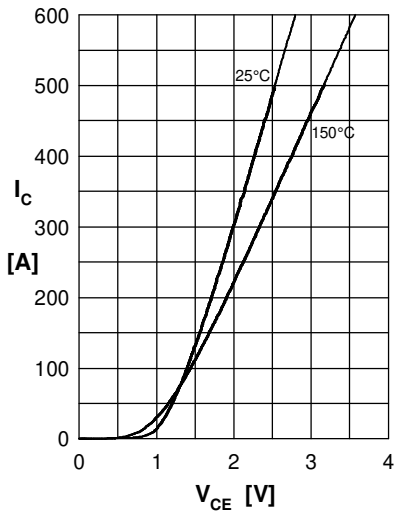

Fig. 1 Typ. output characteristics IGBT

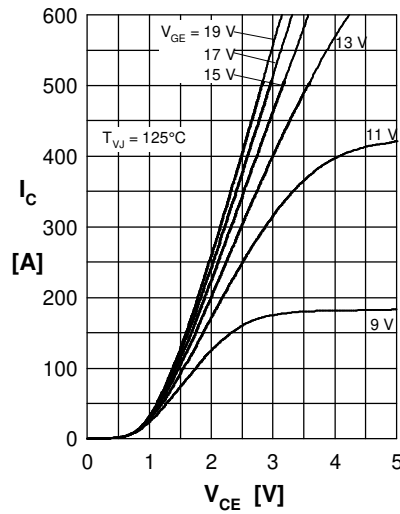

Fig. 2 Typ. output characteristics IGBT

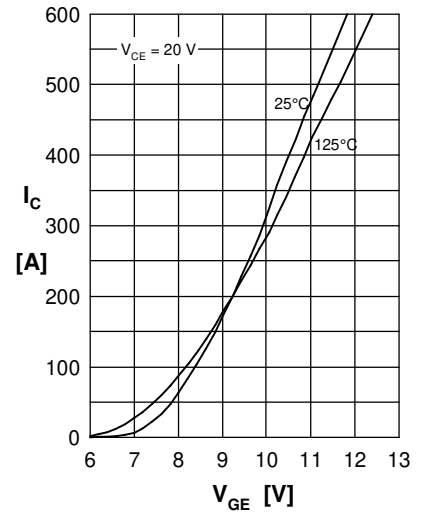

Fig. 3 Typ. transfer charact. IGBT

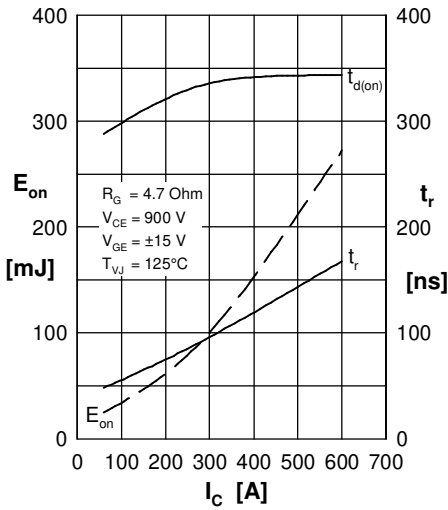

Fig. 4 Typ. turn-on energy & switch times vs. collector current

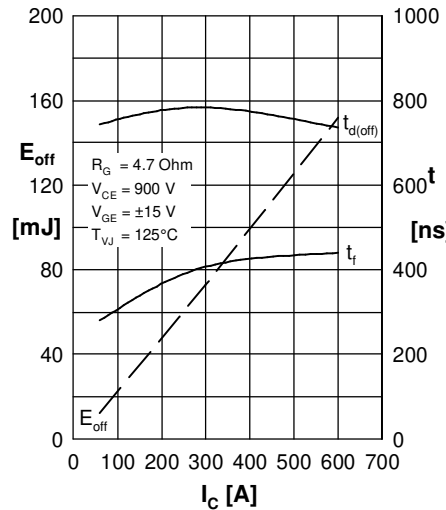

Fig. 5 Typ. turn-off energy & switch times vs. collector current

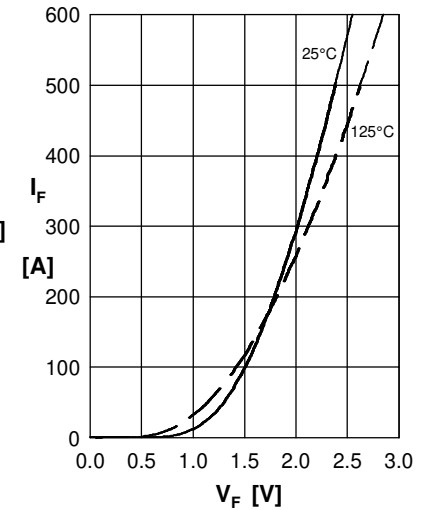

Fig. 6 Typ. forward characteristics Diode

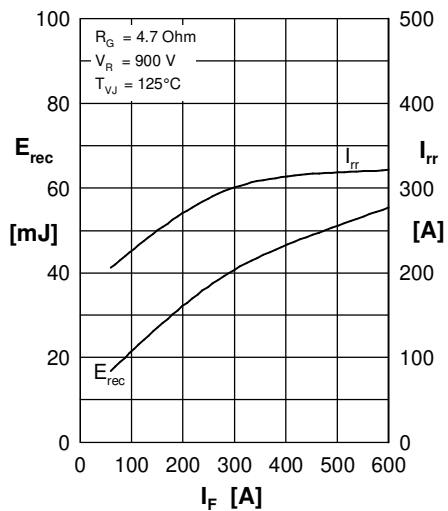

Fig. 7 Typ. reverse recovery characteristics Diode

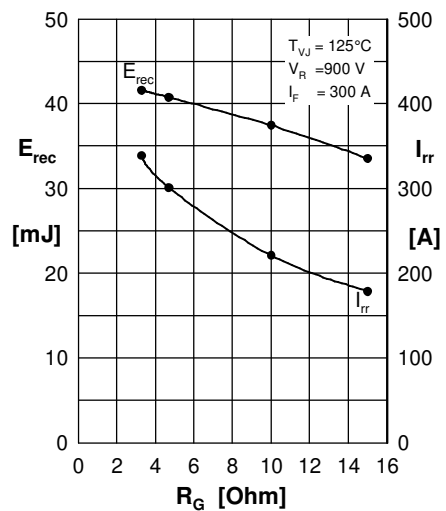

Fig. 8 Typ. reverse recovery characteristics Diode

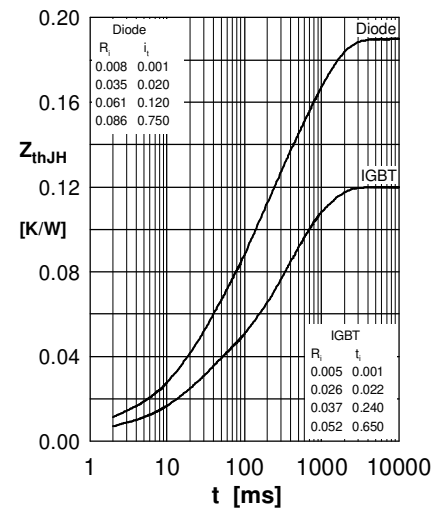

Fig. 9 Typ. transient thermal resistance junction to heatsink



Компания «ЭлектроПласт» предлагает заключение долгосрочных отношений при поставках импортных электронных компонентов на взаимовыгодных условиях!

Наши преимущества:

- Оперативные поставки широкого спектра электронных компонентов отечественного и импортного производства напрямую от производителей и с крупнейших мировых складов;
- Поставка более 17-ти миллионов наименований электронных компонентов;
- Поставка сложных, дефицитных, либо снятых с производства позиций;
- Оперативные сроки поставки под заказ (от 5 рабочих дней);
- Экспресс доставка в любую точку России;
- Техническая поддержка проекта, помощь в подборе аналогов, поставка прототипов;
- Система менеджмента качества сертифицирована по Международному стандарту ISO 9001;
- Лицензия ФСБ на осуществление работ с использованием сведений, составляющих государственную тайну;
- Поставка специализированных компонентов (Xilinx, Altera, Analog Devices, Intersil, Interpoint, Microsemi, Aeroflex, Peregrine, Syfer, Eurofarad, Texas Instrument, Miteq, Cobham, E2V, MA-COM, Hittite, Mini-Circuits, General Dynamics и др.);

Помимо этого, одним из направлений компании «ЭлектроПласт» является направление «Источники питания». Мы предлагаем Вам помощь Конструкторского отдела:

- Подбор оптимального решения, техническое обоснование при выборе компонента;
- Подбор аналогов;
- Консультации по применению компонента;
- Поставка образцов и прототипов;
- Техническая поддержка проекта;
- Защита от снятия компонента с производства.



Как с нами связаться

Телефон: 8 (812) 309 58 32 (многоканальный)

Факс: 8 (812) 320-02-42

Электронная почта: org@eplast1.ru

Адрес: 198099, г. Санкт-Петербург, ул. Калинина, дом 2, корпус 4, литера А.