

Tactile Switch B3W

Tactile Switch with Sealed Construction for Automatic Soldering

- Sealed construction conforming to IP67 (IEC-60529) provides high reliability in locations exposed to dust or water.
- Available in two sizes: 6 mm square and 12 mm square
- Dome-shaped contact mechanism assures short key stroke and a sharp click to confirm actuation
- Ground terminal available to protect against static electricity
- Projected plunger types that allow the installation of B32-series Special Key Tops are available.
- RoHS Compliant

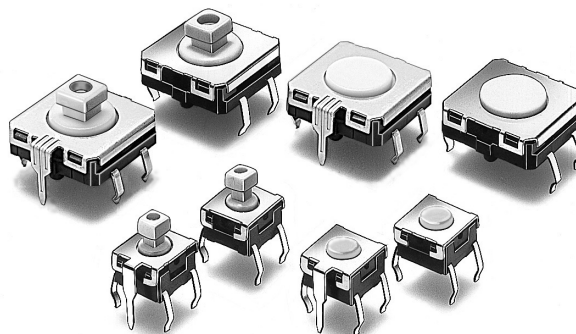

Ordering Information

Type	Plunger	Switch height	Operating force	Model	
				Without ground terminal	With ground terminal
				Bags	Bags
Standard 6x6 mm	Flat 	4.3 mm	General-purpose: 160 g	B3W-1000	B3W-1100
			High-force: 230 g	B3W-1002	B3W-1102
	Projected 	7.3 mm	General-purpose: 160 g	B3W-1050	B3W-1150
			High-force: 230 g	B3W-1052	B3W-1152
Standard 12x12 mm	Flat 	4.3 mm	General-purpose: 200 g	B3W-4000	B3W-4100
			High-force: 350 g	B3W-4005	B3W-4105
	Projected 	7.3 mm	General-purpose: 200 g	B3W-4050	B3W-4150
			High-force: 350 g	B3W-4055	B3W-4155

Note: Bulk Packaged, 100 switches per bag. Order in multiples of the package quantity.

Important Note: Switches cannot be water-washed.

■ Accessories

See “B32” Tactile Switch Key Top data sheet for keycaps that fit projected plunger B3W models.

■ Plunger Identification Table

Use this table to determine keyswitch type by plunger color.

Plunger color	Operating force	Type
White	160 g	B3W-1000, 1050, 1100, 1150
White	200 g	B3W-4000, 4050, 4100, 4150
Yellow	230 g	B3W-1002, 1052, 1102, 1152
Yellow	350 g	B3W-4005, 4055, 4105, 4155

Specifications

■ Characteristics

Contact form		SPST-NO	
Switching capacity		1 to 50 mA, 5 to 24 VDC (resistive load)	
Contact resistance		100 mΩ max. (rated: 1 mA, 5 VDC)	
Insulation resistance		100 MΩ min. (at 250 VDC)	
Dielectric strength		500 VAC, 50/60 Hz for 1 min.	
Bounce time		5 ms max.	
Vibration resistance		Malfunction: 10 to 55 Hz, 1.5-mm double amplitude	
Shock resistance		Destruction: 1,000 m/s ² (approx. 100 G) max. Malfunction: 100 m/s ² (approx. 10 G) max.	
Ambient operating temperature		-25° to 70°C (at 60% RH max.) with no icing or condensation	
Ambient operating humidity		35% to 85% (at 5 to 35°C)	
Service life	General purpose	B3W-1□□□ : 1,000,000 operations min.	B3W-4□□□ : 3,000,000 operations min.
	High force	300,000 operations min.	1,000,000 operations min.
Weight		B3W-1□□□ : Approx. 0.30 g	B3W-4□□□ : Approx. 1.00 g

■ Operating Characteristics

Characteristics	B3W-1□□□		B3W-4□□□	
	General-purpose	High-force	General-purpose	High-force
Operating force (OF) max.	160 g	230 g	200 g	350 g
Release force (RF) min.	20 g	50 g	30 g	50 g
Pretravel (PT)	0.25 ^{+0.2} / _{-0.1} mm		0.3 ^{+0.2} / _{-0.1} mm	

Engineering Data

■ Operating Force vs. Stroke (Typical Example)

B3W-1□□□ series

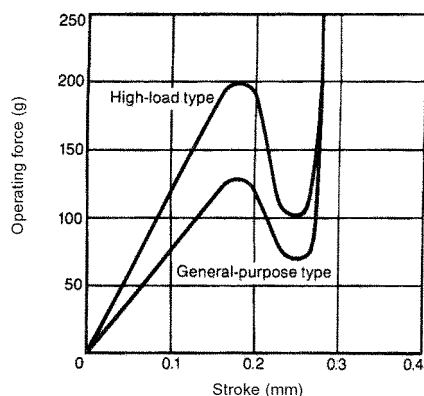

B3W-4□□□ series

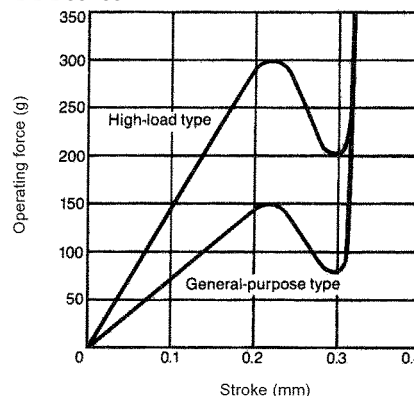

■ Construction

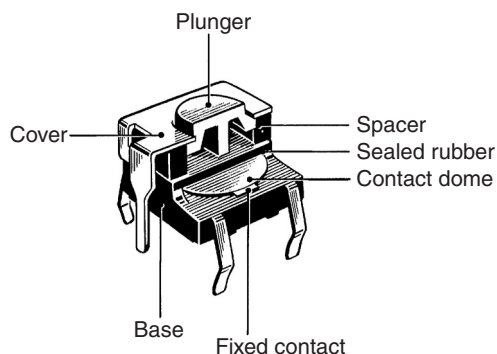

Dimensions

- Note:** 1. Unless otherwise specified, all units are in millimeters and a tolerance of ± 0.4 mm applies to all dimensions.
 2. Terminal numbers are not indicated on this switch. With the switch turned over so that the logo mark "OMRON" is visible on the upper part of the rear side of the switch base, the terminal on the right of the logo mark is numbered "1" and that on the bottom right is "3." Accordingly, two terminals on the left side are numbered "2" and "4" respectively.

6 x 6 mm Models

Flat Plunger Type (without Ground Terminal)

B3W-1000
B3W-1002

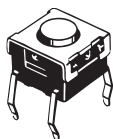

Flat Plunger Type (with Ground Terminal)

B3W-1100
B3W-1102

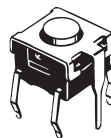

PCB Mounting (Top View)
(Single-sided PCB, $t=1.6$)

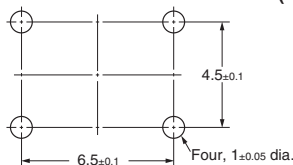

Terminal Arrangement /Internal Connections (Top View)

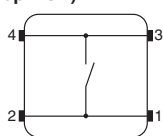

PCB Mounting (Top View)
(Single-sided PCB, $t=1.6$)



Terminal Arrangement /Internal Connections (Top View)

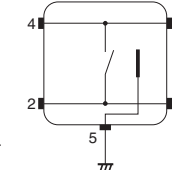

Projected Plunger Type (without Ground Terminal)

B3W-1050
B3W-1052

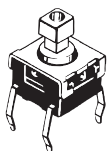

Projected Plunger Type (with Ground Terminal)

B3W-1150
B3W-1152

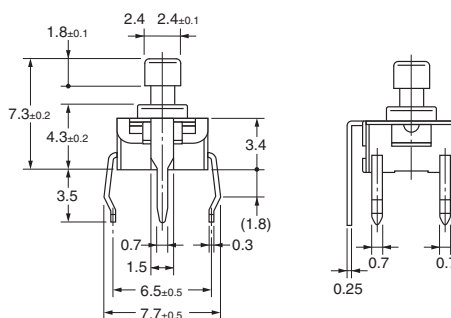
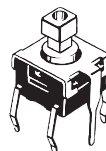
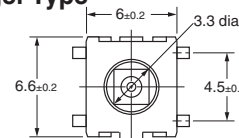

PCB Mounting (Top View)
(Single-sided PCB, $t=1.6$)



Terminal Arrangement /Internal Connections (Top View)

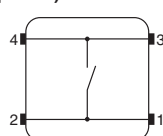

PCB Mounting (Top View)
(Single-sided PCB, $t=1.6$)



Terminal Arrangement /Internal Connections (Top View)

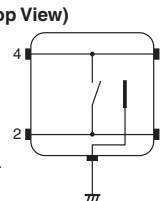

12 x 12 mm Models

Flat Plunger Type
(without Ground Terminal)

B3W-4000
B3W-4005



Flat Plunger Type
(with Ground Terminal)

B3W-4100
B3W-4105

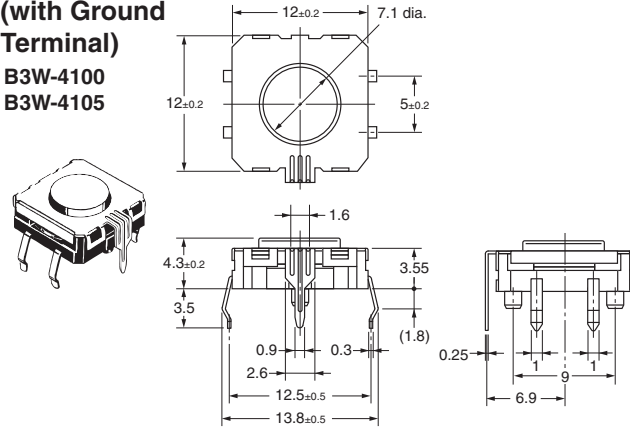

PCB Mounting (Top View)
(Single-sided PCB, t=1.6)

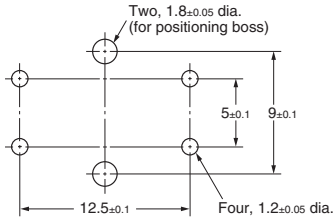

Terminal Arrangement
/Internal Connections
(Top View)

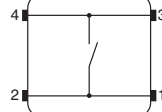

PCB Mounting (Top View)
(Single-sided PCB, t=1.6)

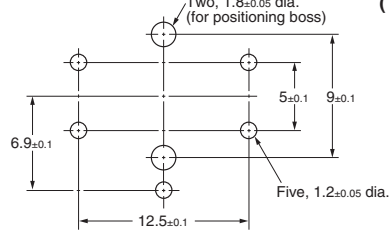

Terminal Arrangement
/Internal Connections
(Top View)

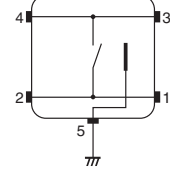

Projected Plunger Type
(without Ground Terminal)

B3W-4050
B3W-4055

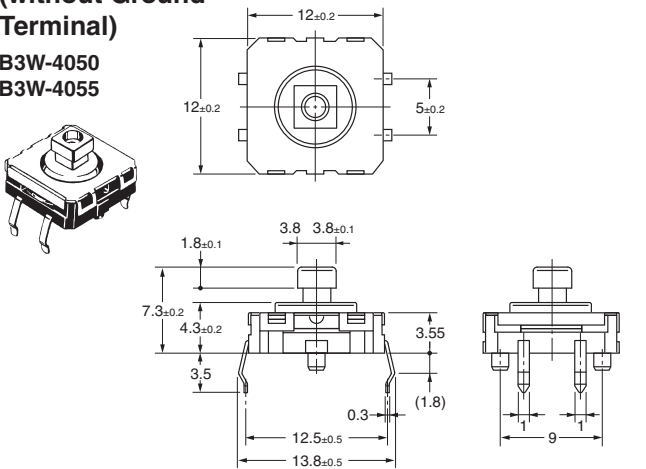

Projected Plunger Type
(with Ground Terminal)

B3W-4150
B3W-4155

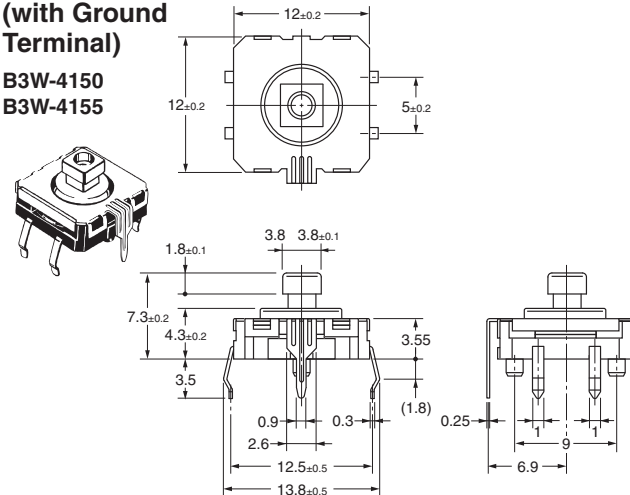

PCB Mounting (Top View)
(Single-sided PCB, t=1.6)

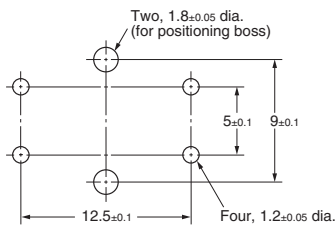

Terminal Arrangement
/Internal Connections
(Top View)

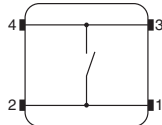

PCB Mounting (Top View)
(Single-sided PCB, t=1.6)

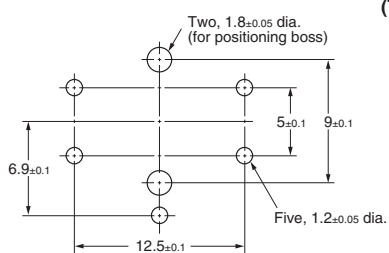

Terminal Arrangement
/Internal Connections
(Top View)

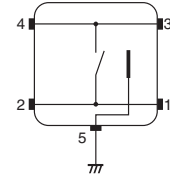

Precautions

Be sure to read the precautions common to all Tactile Switches, contained in the Technical User's Guide, "Tactile Switches, Technical Information" for correct use.



All sales are subject to Omron Electronic Components LLC standard terms and conditions of sale, which can be found at http://www.components.omron.com/components/web/webfiles.nsf/sales_terms.html

ALL DIMENSIONS SHOWN ARE IN MILLIMETERS.
To convert millimeters into inches, multiply by 0.03937. To convert grams into ounces, multiply by 0.03527.

OMRON[®]

**OMRON ELECTRONIC
COMPONENTS LLC**

55 E. Commerce Drive, Suite B
Schaumburg, IL 60173

847-882-2288

OMRON ON-LINE

Global - <http://www.omron.com>

USA - <http://www.components.omron.com>



Компания «ЭлектроПласт» предлагает заключение долгосрочных отношений при поставках импортных электронных компонентов на взаимовыгодных условиях!

Наши преимущества:

- Оперативные поставки широкого спектра электронных компонентов отечественного и импортного производства напрямую от производителей и с крупнейших мировых складов;
- Поставка более 17-ти миллионов наименований электронных компонентов;
- Поставка сложных, дефицитных, либо снятых с производства позиций;
- Оперативные сроки поставки под заказ (от 5 рабочих дней);
- Экспресс доставка в любую точку России;
- Техническая поддержка проекта, помощь в подборе аналогов, поставка прототипов;
- Система менеджмента качества сертифицирована по Международному стандарту ISO 9001;
- Лицензия ФСБ на осуществление работ с использованием сведений, составляющих государственную тайну;
- Поставка специализированных компонентов (Xilinx, Altera, Analog Devices, Intersil, Interpoint, Microsemi, Aeroflex, Peregrine, Syfer, Eurofarad, Texas Instrument, Miteq, Cobham, E2V, MA-COM, Hittite, Mini-Circuits, General Dynamics и др.);

Помимо этого, одним из направлений компании «ЭлектроПласт» является направление «Источники питания». Мы предлагаем Вам помощь Конструкторского отдела:

- Подбор оптимального решения, техническое обоснование при выборе компонента;
- Подбор аналогов;
- Консультации по применению компонента;
- Поставка образцов и прототипов;
- Техническая поддержка проекта;
- Защита от снятия компонента с производства.



Как с нами связаться

Телефон: 8 (812) 309 58 32 (многоканальный)

Факс: 8 (812) 320-02-42

Электронная почта: org@eplast1.ru

Адрес: 198099, г. Санкт-Петербург, ул. Калинина, дом 2, корпус 4, литера А.