

HLMP-ADxx/AGxx/ALxx/BDxx/BGxx/BLxx

5mm mini Oval Precision Optical Performance

AllnGaP Lamps



Data Sheet



Lead (Pb) Free
RoHS 6 fully
compliant



Description

These Precision Optical Performance Oval LEDs are specifically designed for full color/video and passenger information signs. The oval shaped radiation pattern (35° x 70°) and high luminous intensity ensure that these devices are excellent for wide field of view outdoor application where a wide viewing angle and readability in sunlight are essential. These lamps have very smooth, matched radiation patterns ensuring consistent color mixing in full color applications, message uniformity across the viewing angle of the sign.

High efficiency LED material is used in these lamps: Aluminum Indium Gallium Phosphide (AllnGaP) for amber and red. Each lamp is made with an advance optical grade epoxy offering superior high temperature and high moisture resistance in outdoor applications. The package epoxy contains both UV-A and UV-B inhibitors to reduce the effects of long term exposure to direct sunlight.

Designers can select parallel or perpendicular orientation. Both lamps are available in tinted version.

Benefits

- Viewing angle designed for wide field of view application
- Superior performance in outdoor environments

Features

- Well defined spatial radiation pattern
- Viewing angles:
Major axis 70°
Minor axis 35°
- High luminous output
- Red and Amber intensity are available for:
AllnGaP (Bright)
AllnGaP II (Brightest)
- Colors:
626 nm red
630 nm red
590 nm amber
592 nm amber
- Superior resistance to moisture
- UV resistant epoxy

Applications

- Full color/video signs

Table 1. Device Selection Guide for AlInGaP II

Part Number	Color and Dominant Wavelength λ_d (nm) Typ.	Luminous Intensity Iv (mcd) at 20 mA Min.	Luminous Intensity Iv (mcd) at 20 mA Max.	Stand-Off	Leadframe Orientation	Package Drawing
HLMP-AD06-NSTxx	Red 630	680	2500	No	Parallel	A
HLMP-AD06-P00xx	Red 630	880		No	Parallel	A
HLMP-AD06-P0Txx	Red 630	880		No	Parallel	A
HLMP-AD06-PQ0xx	Red 630	880	1500	No	Parallel	A
HLMP-AD06-RSTxx	Red 630	1500	2500	No	Parallel	A
HLMP-AD06-STTxx	Red 630	1900	3200	No	Parallel	A
HLMP-AD16-P00xx	Red 630	880		Yes	Parallel	B
HLMP-AD16-QTTxx	Red 630	1150	3200	Yes	Parallel	B
HLMP-AD16-RS0xx	Red 630	1500	2500	Yes	Parallel	B
HLMP-AD16-RSTxx	Red 630	1500	2500	Yes	Parallel	B
HLMP-AD16-RUTxx	Red 630	1500	4200	Yes	Parallel	B
HLMP-AD16-ST0xx	Red 630	1900	3200	Yes	Parallel	B
HLMP-AD16-STTxx	Red 630	1900	3200	Yes	Parallel	B
HLMP-AL16-RSRxx	Amber 592	1500	2500	Yes	Parallel	B
HLMP-AL16-RSKxx	Amber 592	1500	2500	Yes	Parallel	B
HLMP-BD06-L00xx	Red 630	400		No	Perpendicular	C
HLMP-BD06-P00xx	Red 630	880		No	Perpendicular	C
HLMP-BD06-RS0xx	Red 630	1500	2500	No	Perpendicular	C
HLMP-BD06-RSTxx	Red 630	1500	2500	No	Perpendicular	C
HLMP-BD06-STTxx	Red 630	1900	3200	No	Perpendicular	C
HLMP-BD16-NP0xx	Red 630	680	1150	Yes	Perpendicular	D
HLMP-BD16-QRTxx	Red 630	1150	1900	Yes	Perpendicular	D
HLMP-BD16-RU0xx	Red 630	1500	4200	Yes	Perpendicular	D
HLMP-BD16-RUTxx	Red 630	1500	4200	Yes	Perpendicular	D
HLMP-BD16-ST0xx	Red 630	1900	3200	Yes	Perpendicular	D
HLMP-BD16-STTxx	Red 630	1900	3200	Yes	Perpendicular	D
HLMP-BL06-N00xx	Amber 592	680		No	Perpendicular	C

Table 2. Device Selection Guide for AlInGaP

Part Number	Color and Dominant Wavelength λ_d (nm) Typ.	Luminous Intensity I_v (mcd) at 20 mA Min.	Luminous Intensity I_v (mcd) at 20 mA Max.	Stand-Off	Leadframe Orientation	Package Drawing
HLMP-AG01-K00xx	Red 626	310		No	Parallel	A
HLMP-AL01-L00xx	Amber 590	400		No	Parallel	A
HLMP-AL01-LP0xx	Amber 590	400	1150	No	Parallel	A
HLMP-AL01-N00xx	Amber 590	680		No	Parallel	A
HLMP-AL01-NR0xx	Amber 590	680	1900	No	Parallel	A
HLMP-AL01-PQKxx	Amber 590	880	1150	No	Parallel	A
HLMP-AL11-NR0xx	Amber 590	880	1900	Yes	Parallel	B
HLMP-BG01-LM0xx	Red 626	400	520	No	Perpendicular	C
HLMP-BG01-MN0xx	Red 626	520	680	No	Perpendicular	C
HLMP-BL01-NR0xx	Red 626	680	1900	No	Perpendicular	C
HLMP-BL11-KN0xx	Red 626	310	880	Yes	Perpendicular	D
HLMP-BL11-NR0xx	Red 626	680	1900	Yes	Perpendicular	D

Part Numbering System

HLMP - X X X X - X X X XX

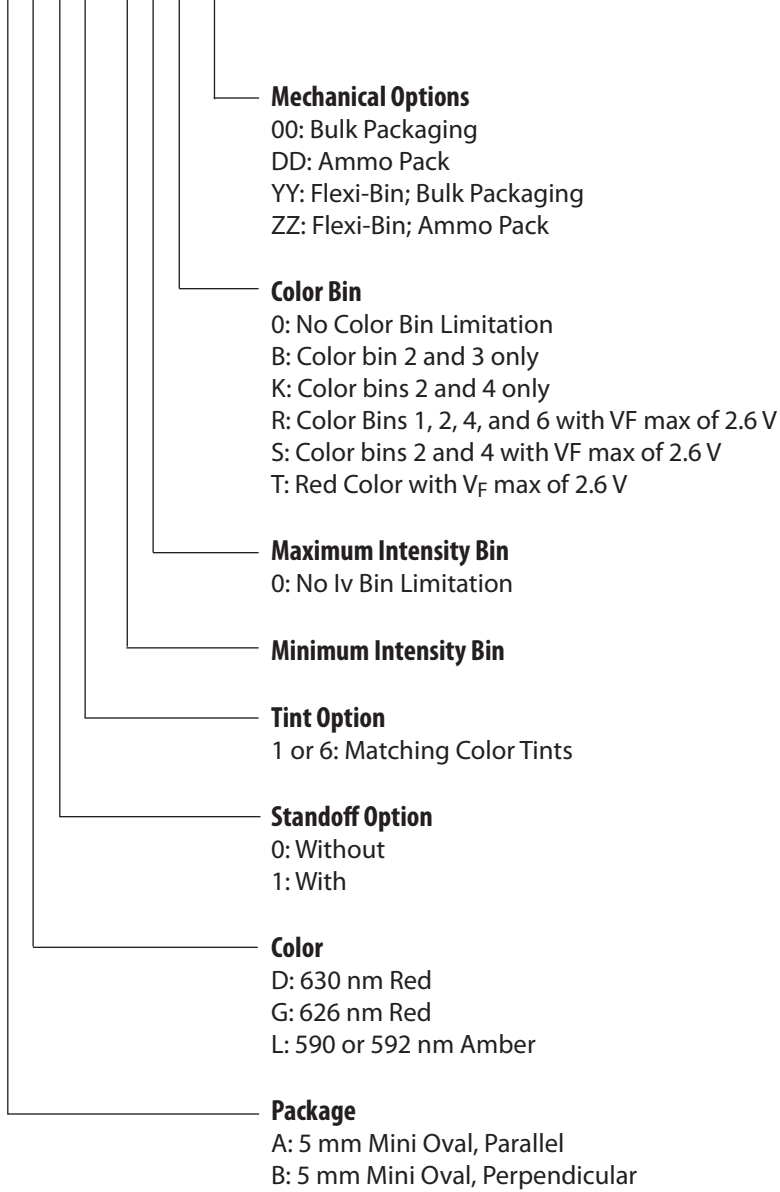

Note: Please refer to AB 5337 for complete information on part numbering system.

Package Dimensions

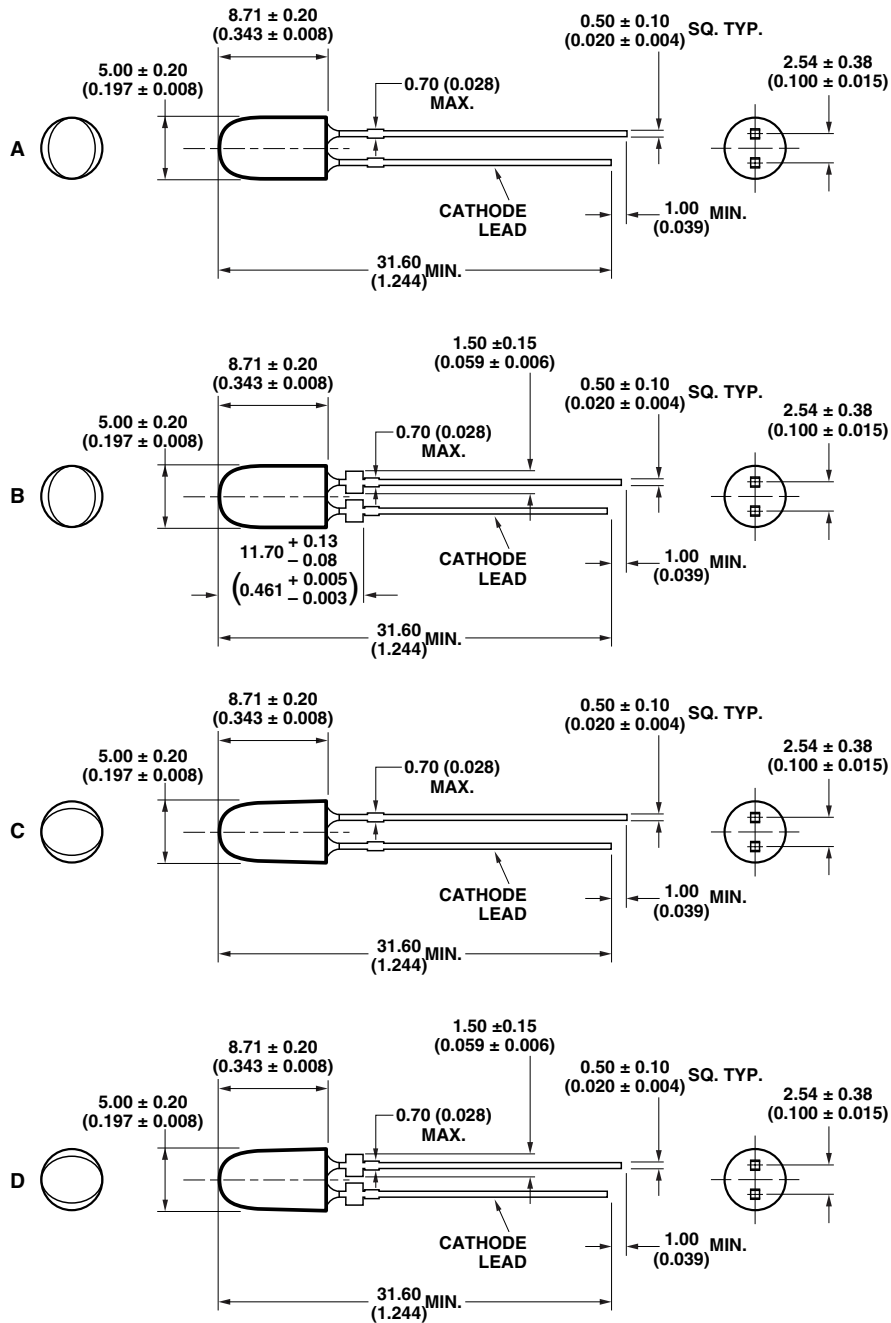

NOTES:

- ALL DIMENSIONS ARE IN MILLIMETERS (INCHES).
- TAPERS SHOWN AT TOP OF LEADS (BOTTOM OF LAMP PACKAGE) INDICATE AN EPOXY MENISCUS THAT MAY EXTEND ABOUT 1 mm (0.040 IN.) DOWN THE LEADS.
- RECOMMENDED PC BOARD HOLE DIAMETERS:
 - LAMP PACKAGES A AND C WITHOUT STAND-OFFS: FLUSH MOUNTING AT BASE OF LAMP PACKAGE = 1.143/1.067 mm (0.044/0.042 IN.).
 - LAMP PACKAGES B AND D WITH STAND-OFFS: MOUNTING AT LEAD STAND-OFFS.

Absolute Maximum Ratings at $T_A = 25^\circ\text{C}$

Parameter	Red and Amber
DC Forward Current ^[1]	50 mA
Peak Pulsed Forward Current ^[2]	100 mA
Average Forward Current	30 mA
Reverse Voltage ($I_R = 100\ \mu\text{A}$)	5 V
Power Dissipation	120 mW
LED Junction Temperature	130°C
Operating Temperature Range	-40°C to +100°C
Storage Temperature Range	-40°C to +100°C

Notes:

1. Derate linearly as shown in figure 4.
2. Duty Factor 30%, Frequency 1kHz.

Electrical/Optical Characteristics at $T_A = 25^\circ\text{C}$

Parameter	Symbol	Min.	Typ.	Max.	Units	Test Conditions
Typical Viewing Angle						
Major	$2\theta_{1/2}$		70		deg	
Minor			35			
Forward Voltage	V_F				V	$I_F = 20\ \text{mA}$
Red ($\lambda_d = 626\ \text{nm}$)			2.0	2.4		
Red ($\lambda_d = 630\ \text{nm}$)						
Option xx0xx			2.2	2.4		
Option xxTxx			2.3	2.6		
Amber ($\lambda_d = 590\ \text{nm}$)			2.0	2.4		
Amber ($\lambda_d = 592\ \text{nm}$)						
Option xx0xx			2.2	2.4		
Option xxRxx, xxSxx			2.3	2.6		
Reverse Voltage						
Amber, Red	V_R	5	20		V	$I_R = 100\ \mu\text{A}$
Peak Wavelength						Peak of Wavelength of Spectral Distribution at $I_F = 20\ \text{mA}$
Amber ($\lambda_d = 592\ \text{nm}$)	λ_{peak}		594		nm	
Red ($\lambda_d = 630\ \text{nm}$)			639			
Spectral Halfwidth						Wavelength Width at Spectral Distribution 1/2 Power Point at $I_F = 20\ \text{mA}$
Amber ($\lambda_d = 592\ \text{nm}$)	$\Delta\lambda_{1/2}$		17		nm	
Red ($\lambda_d = 630\ \text{nm}$)			17			
Capacitance						$V_F = 0, F = 1\ \text{MHz}$
Amber, Red	C		40		pF	
Luminous Efficacy						Emitted Luminous Power/Emitted Radiant Power at $I_F = 20\ \text{mA}$
Amber ($\lambda_d = 592\ \text{nm}$)	η_v		500		lm/W	
Red ($\lambda_d = 630\ \text{nm}$)			155			
Thermal Resistance	$R_{\Theta\text{J-PIN}}$		240		$^\circ\text{C/W}$	LED Junction-to-Cathode Lead

Notes:

1. $2\theta_{1/2}$ is the off-axis angle where the luminous intensity is 1/2 the on-axis intensity.
2. The radiant intensity, I_e in watts per steradian, may be found from the equation $I_e = I_v/\eta_v$, where I_v is the luminous intensity in candelas and η_v is the luminous efficacy in lumens/watt.
3. The luminous intensity is measured on the mechanical axis of the lamp package.
4. The optical axis is closely aligned with the package mechanical axis.
5. The dominant wavelength, λ_d , is derived from the CIE Chromaticity Diagram and represents the color of the lamp.
6. For Options -xxRxx, -xxSxx and -xxTxx, max. forward voltage (V_f) is 2.6 V. Refer to V_f bin table.

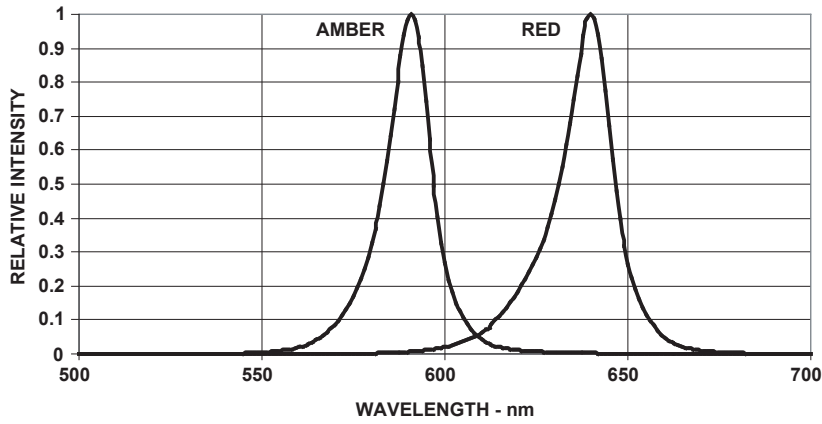

Figure 1. Relative intensity vs. wavelength.

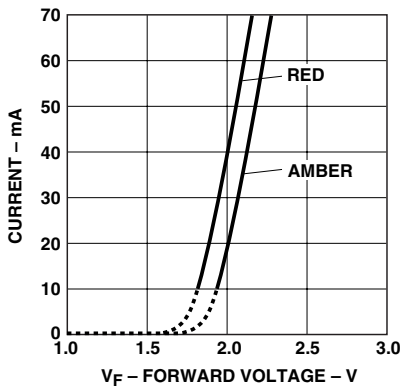

Figure 2a. Amber, red forward current vs. forward voltage.

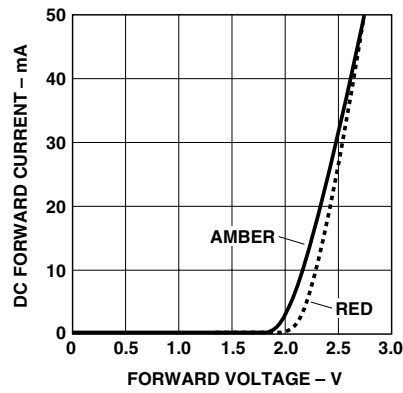

Figure 2b. Forward current vs. forward voltage for option -xxTxx red, and option -xxRxx and -xxSxx amber.

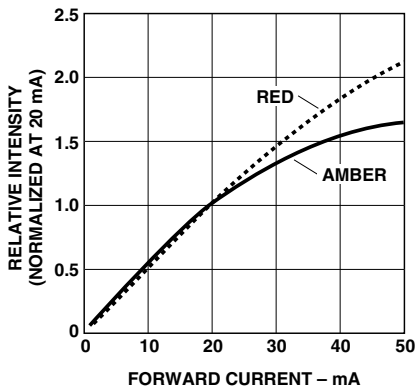

Figure 3. Amber, red relative luminous intensity vs. forward current.

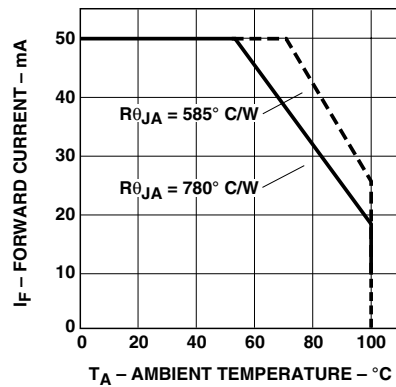

Figure 4. Amber, red maximum forward current vs. ambient temperature.

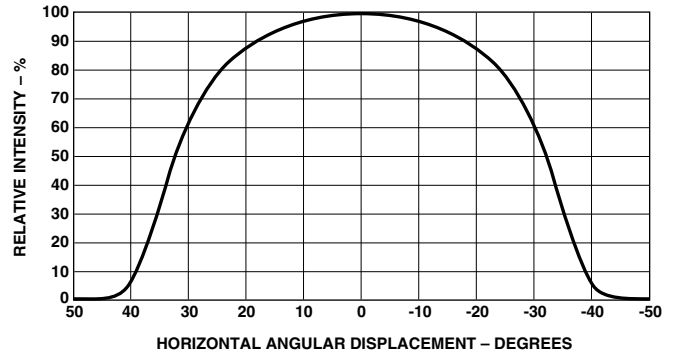
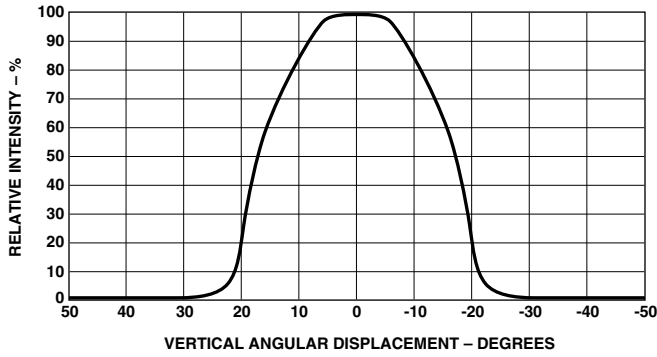

Figure 5. Spatial radiation pattern – 35 x 70 degree lamps.

Intensity Bin Limits (mcd at 20 mA)

Bin Name	Min.	Max.
K	310	400
L	400	520
M	520	680
N	680	880
P	880	1150
Q	1150	1500
R	1500	1900
S	1900	2500
T	2500	3200
U	3200	4200

Tolerance for each bin limit is $\pm 15\%$.

Amber Color Bin Limits (nm at 20 mA)

Bin Name	Min.	Max.
1	584.5	587.0
2	587.0	589.5
4	589.5	592.0
6	592.0	594.5

Tolerance for each bin limit is ± 0.5 nm.

Vf Bin Table [2,3]

Bin Id	Min.	Max.
VA	2.0	2.2
VB	2.2	2.4
VC	2.4	2.6

Notes:

1. All bin categories are established for classification of products. Products may not be available in all bin categories. Please contact your Avago representative for further information.
2. Vf bin table only available for those numbers with options -xxRxx, -xxSxx, -xxTxx.
3. Tolerance for each bin limit is $\pm 0.05V$

Precautions:

Lead Forming:

- The leads of an LED lamp may be preformed or cut to length prior to insertion and soldering on PC board.
- For better control, it is recommended to use proper tool to precisely form and cut the leads to applicable length rather than doing it manually.
- If manual lead cutting is necessary, cut the leads after the soldering process. The solder connection forms a mechanical ground which prevents mechanical stress due to lead cutting from traveling into LED package. This is highly recommended for hand solder operation, as the excess lead length also acts as small heat sink.

Soldering and Handling:

- Care must be taken during PCB assembly and soldering process to prevent damage to the LED component.
- LED component may be effectively hand soldered to PCB. However, it is only recommended under unavoidable circumstances such as rework. The closest manual soldering distance of the soldering heat source (soldering iron's tip) to the body is 1.59mm. Soldering the LED using soldering iron tip closer than 1.59mm might damage the LED.

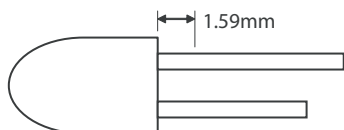

- ESD precaution must be properly applied on the soldering station and personnel to prevent ESD damage to the LED component that is ESD sensitive. Do refer to Avago application note AN 1142 for details. The soldering iron used should have grounded tip to ensure electrostatic charge is properly grounded.
- Recommended soldering condition:

	Wave Soldering [1, 2]	Manual Solder Dipping
Pre-heat temperature	105 °C Max.	-
Preheat time	60 sec Max	-
Peak temperature	250 °C Max.	260 °C Max.
Dwell time	3 sec Max.	5 sec Max

Note:

- 1) Above conditions refers to measurement with thermocouple mounted at the bottom of PCB.
 - 2) It is recommended to use only bottom preheaters in order to reduce thermal stress experienced by LED.
- Wave soldering parameters must be set and maintained according to the recommended temperature and dwell time. Customer is advised to perform daily check on the soldering profile to ensure that it is always conforming to recommended soldering conditions.

Note:

1. PCB with different size and design (component density) will have different heat mass (heat capacity). This might cause a change in temperature experienced by the board if same wave soldering setting is used. So, it is recommended to re-calibrate the soldering profile again before loading a new type of PCB.
2. Avago Technologies' high brightness LED are using high efficiency LED die with single wire bond as shown below. Customer is advised to take extra precaution during wave soldering to ensure that the maximum wave temperature does not exceed 250°C and the solder contact time does not exceeding 3sec. Over-stressing the LED during soldering process might cause premature failure to the LED due to delamination.

Avago Technologies LED configuration

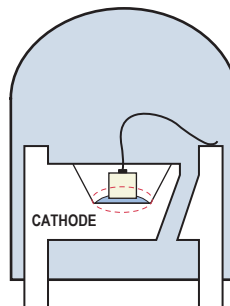

Note: Electrical connection between bottom surface of LED die and the lead frame is achieved through conductive paste.

- Any alignment fixture that is being applied during wave soldering should be loosely fitted and should not apply weight or force on LED. Non metal material is recommended as it will absorb less heat during wave soldering process.
- At elevated temperature, LED is more susceptible to mechanical stress. Therefore, PCB must allowed to cool down to room temperature prior to handling, which includes removal of alignment fixture or pallet.
- If PCB board contains both through hole (TH) LED and other surface mount components, it is recommended that surface mount components be soldered on the top side of the PCB. If surface mount need to be on the bottom side, these components should be soldered using reflow soldering prior to insertion the TH LED.
- Recommended PC board plated through holes (PTH) size for LED component leads.

LED component lead size	Diagonal	Plated through hole diameter
0.45 x 0.45 mm (0.018x 0.018 inch)	0.636 mm (0.025 inch)	0.98 to 1.08 mm (0.039 to 0.043 inch)
0.50 x 0.50 mm (0.020x 0.020 inch)	0.707 mm (0.028 inch)	1.05 to 1.15 mm (0.041 to 0.045 inch)

- Over-sizing the PTH can lead to twisted LED after clinching. On the other hand under sizing the PTH can cause difficulty inserting the TH LED.

Refer to application note AN5334 for more information about soldering and handling of high brightness TH LED lamps.

Example of Wave Soldering Temperature Profile for TH LED

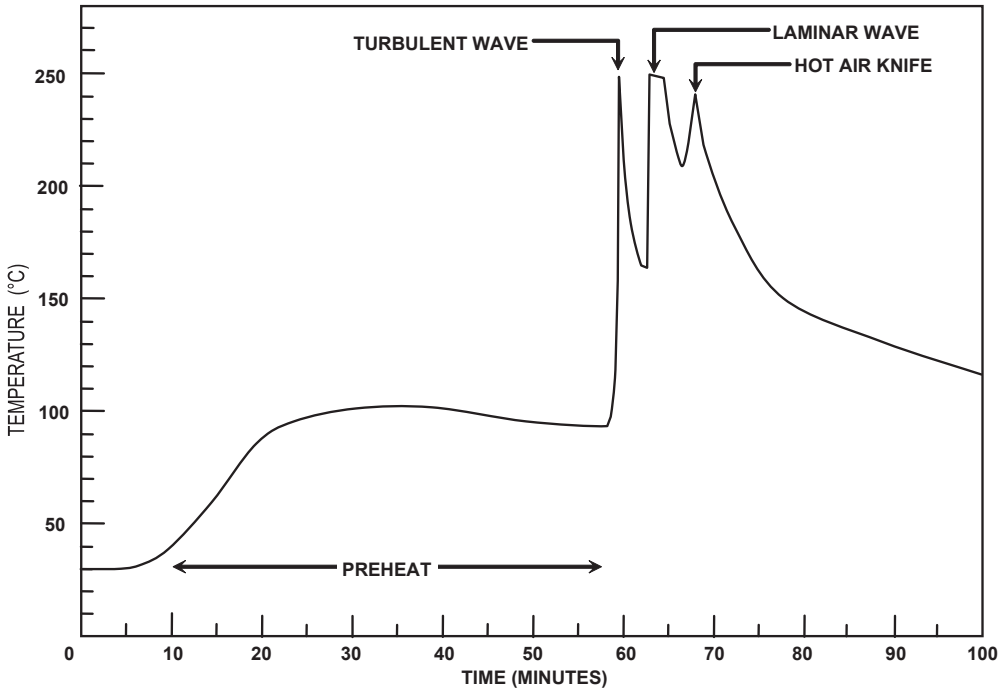

Recommended solder:
Sn63 (Leaded solder alloy)
SAC305 (Lead free solder alloy)

Flux: Rosin flux

Solder bath temperature:
245°C ± 5°C (maximum peak
temperature = 250°C)

Dwell time: 1.5 sec - 3.0 sec
(maximum = 3sec)

Note: Allow for board to be sufficiently
cooled to room temperature before
exerting mechanical force.

Ammo Packs Drawing

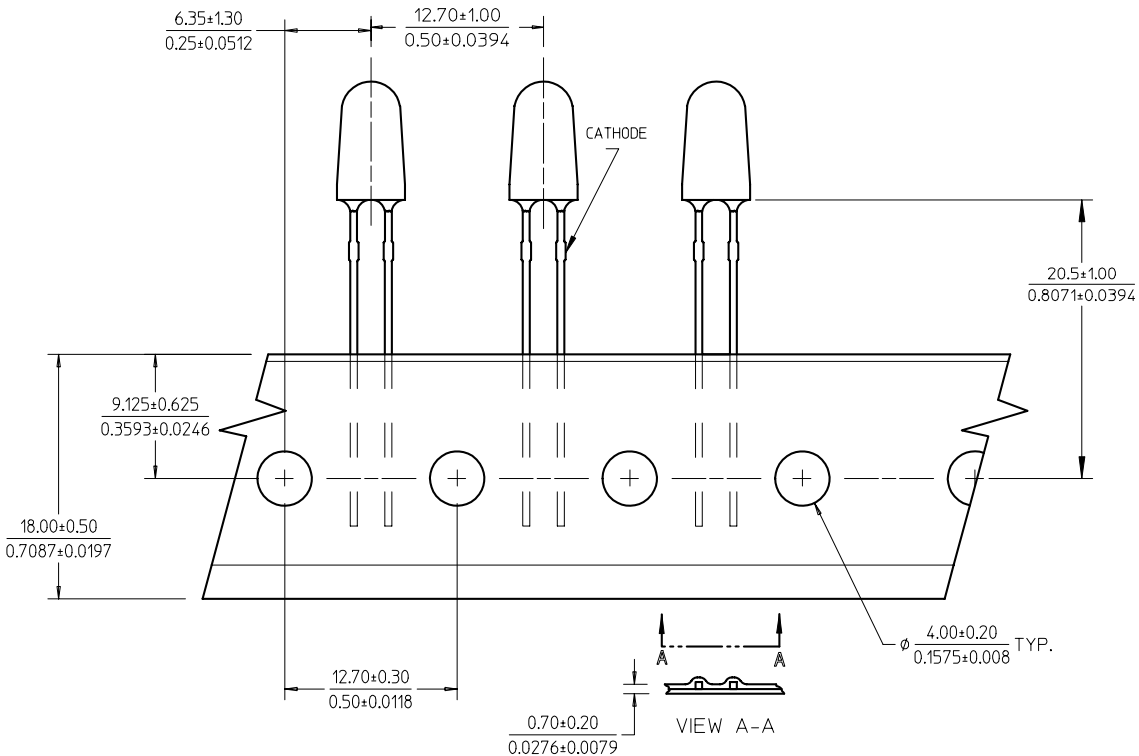

Note: The ammo-packs drawing is applicable for packaging option -DD & -ZZ and regardless of standoff or non-standoff.

Packaging Box for Ammo Packs

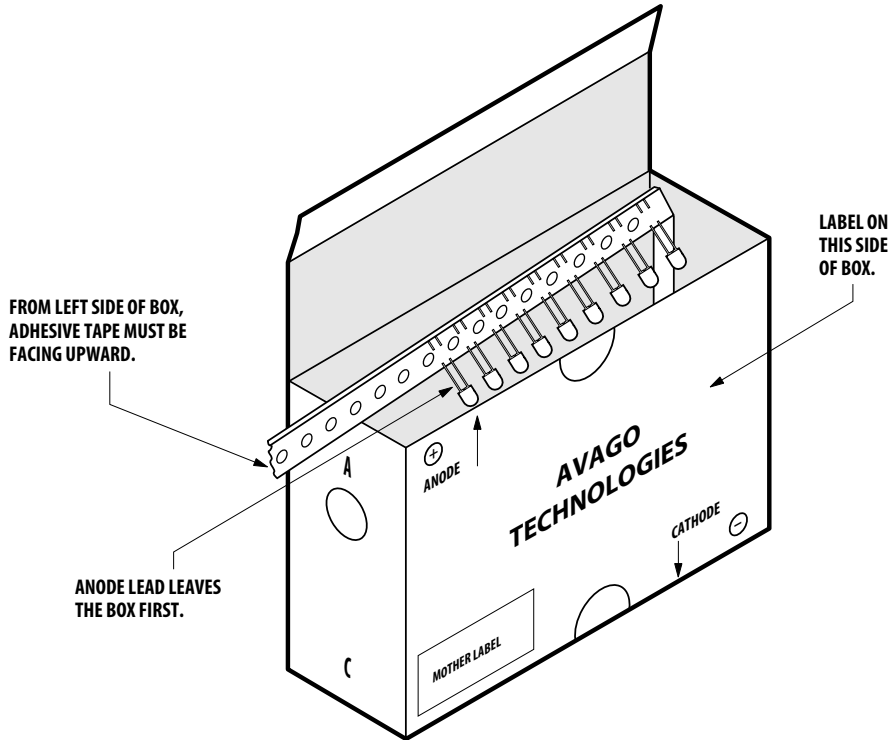











Note: For InGaN device, the ammo pack packaging box contains ESD logo.

Packaging Label

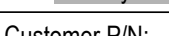
(i) Avago Mother Label: (Available on packaging box of ammo pack and shipping box)

AVAGO TECHNOLOGIES	
(1P) Item: Part Number [Barcode]	STANDARD LABEL LS0002 RoHS Compliant e3 max temp 250C
(1T) Lot: Lot Number [Barcode]	(Q) QTY: Quantity [Barcode]
LPN: [Barcode]	CAT: Intensity Bin [Barcode]
(9D)MFG Date: Manufacturing Date [Barcode]	BIN: Refer to below information
<hr/>	
(P) Customer Item: [Barcode]	
(V) Vendor ID: [Barcode]	(9D) Date Code: Date Code [Barcode]
DeptID: [Barcode]	Made In: Country of Origin [Barcode]

(ii) Avago Baby Label (Only available on bulk packaging)

 Lamps Baby Label		RoHS Compliant e3 max temp 250C
(1P) PART #: Part Number 		
(1T) LOT #: Lot Number 		
(9D)MFG DATE: Manufacturing Date 	QUANTITY: Packing Quantity 	
C/O: Country of Origin 		
Customer P/N: 	CAT: Intensity Bin 	
Supplier Code: 	BIN: Refer to below information 	
	DATECODE: Date Code 	

Acronyms and Definition:

BIN:

- (i) Color bin only or VF bin only
 (Applicable for part number with color bins but without VF bin OR part number with VF bins and no color bin)
 OR
- (ii) Color bin incorporated with VF Bin
 (Applicable for part number that have both color bin and VF bin)

Example:

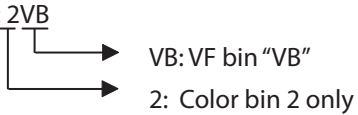
- (i) Color bin only or VF bin only
 BIN: 2 (represent color bin 2 only)
 BIN: VB (represent VF bin "VB" only)
- (ii) Color bin incorporate with VF Bin
 BIN: 2VB

DISCLAIMER: AVAGO'S PRODUCTS AND SOFTWARE ARE NOT SPECIFICALLY DESIGNED, MANUFACTURED OR AUTHORIZED FOR SALE AS PARTS, COMPONENTS OR ASSEMBLIES FOR THE PLANNING, CONSTRUCTION, MAINTENANCE OR DIRECT OPERATION OF A NUCLEAR FACILITY OR FOR USE IN MEDICAL DEVICES OR APPLICATIONS. CUSTOMER IS SOLELY RESPONSIBLE, AND WAIVES ALL RIGHTS TO MAKE CLAIMS AGAINST AVAGO OR ITS SUPPLIERS, FOR ALL LOSS, DAMAGE, EXPENSE OR LIABILITY IN CONNECTION WITH

For product information and a complete list of distributors, please go to our web site: www.avagotech.com



Компания «ЭлектроПласт» предлагает заключение долгосрочных отношений при поставках импортных электронных компонентов на взаимовыгодных условиях!

Наши преимущества:

- Оперативные поставки широкого спектра электронных компонентов отечественного и импортного производства напрямую от производителей и с крупнейших мировых складов;
- Поставка более 17-ти миллионов наименований электронных компонентов;
- Поставка сложных, дефицитных, либо снятых с производства позиций;
- Оперативные сроки поставки под заказ (от 5 рабочих дней);
- Экспресс доставка в любую точку России;
- Техническая поддержка проекта, помощь в подборе аналогов, поставка прототипов;
- Система менеджмента качества сертифицирована по Международному стандарту ISO 9001;
- Лицензия ФСБ на осуществление работ с использованием сведений, составляющих государственную тайну;
- Поставка специализированных компонентов (Xilinx, Altera, Analog Devices, Intersil, Interpoint, Microsemi, Aeroflex, Peregrine, Syfer, Eurofarad, Texas Instrument, Miteq, Cobham, E2V, MA-COM, Hittite, Mini-Circuits, General Dynamics и др.);

Помимо этого, одним из направлений компании «ЭлектроПласт» является направление «Источники питания». Мы предлагаем Вам помощь Конструкторского отдела:

- Подбор оптимального решения, техническое обоснование при выборе компонента;
- Подбор аналогов;
- Консультации по применению компонента;
- Поставка образцов и прототипов;
- Техническая поддержка проекта;
- Защита от снятия компонента с производства.



Как с нами связаться

Телефон: 8 (812) 309 58 32 (многоканальный)

Факс: 8 (812) 320-02-42

Электронная почта: org@eplast1.ru

Адрес: 198099, г. Санкт-Петербург, ул. Калинина, дом 2, корпус 4, литера А.