



Microtips

TECHNOLOGY

Model No: MT061 6ST 0E

TEL: 1-888-499-TIPS (8477)

FAX: (407) 273-0771

E-MAIL: mtusainfo@microtipsusa.com

WEB: www.microtipsusa.com

Record of Revision

Date	Revision No.	Summary
2016-12-15	1.0	Rev 1.0 was issued

1. Scope

This data sheet is to introduce the specification of **MTD0240LMC-6** active matrix TFT module. It is composed of a color TFT-LCD panel, driver IC, FPC and a backlight unit. The 2.4” display area contains 240(RGB) x320 pixels.

2. Application

Digital equipments which need color display, mobile phone, mobile navigator/video systems.

3. General Information

Item	Contents	Unit
Size	2.4	inch
Resolution	240(RGB) x 320	/
Interface	CPU 16-bit	/
Technology type	a-Si TFT	/
Pixel pitch	0.153 x 0.153	mm
Pixel Configuration	R.G.B. Vertical Stripe	
Viewing Direction	6 o'clock	
Outline Dimension (W x H x D)	42.72 x 59.4 x 2.15	mm
Active Area	36.72 x 48.96	mm
Display Mode	Transmissive, Normally white	/
Surface Polarizer	Clear type	/
Backlight Type	6 LEDs (Parallel)	/
Driver IC	ILI9341	

4. Outline Drawing

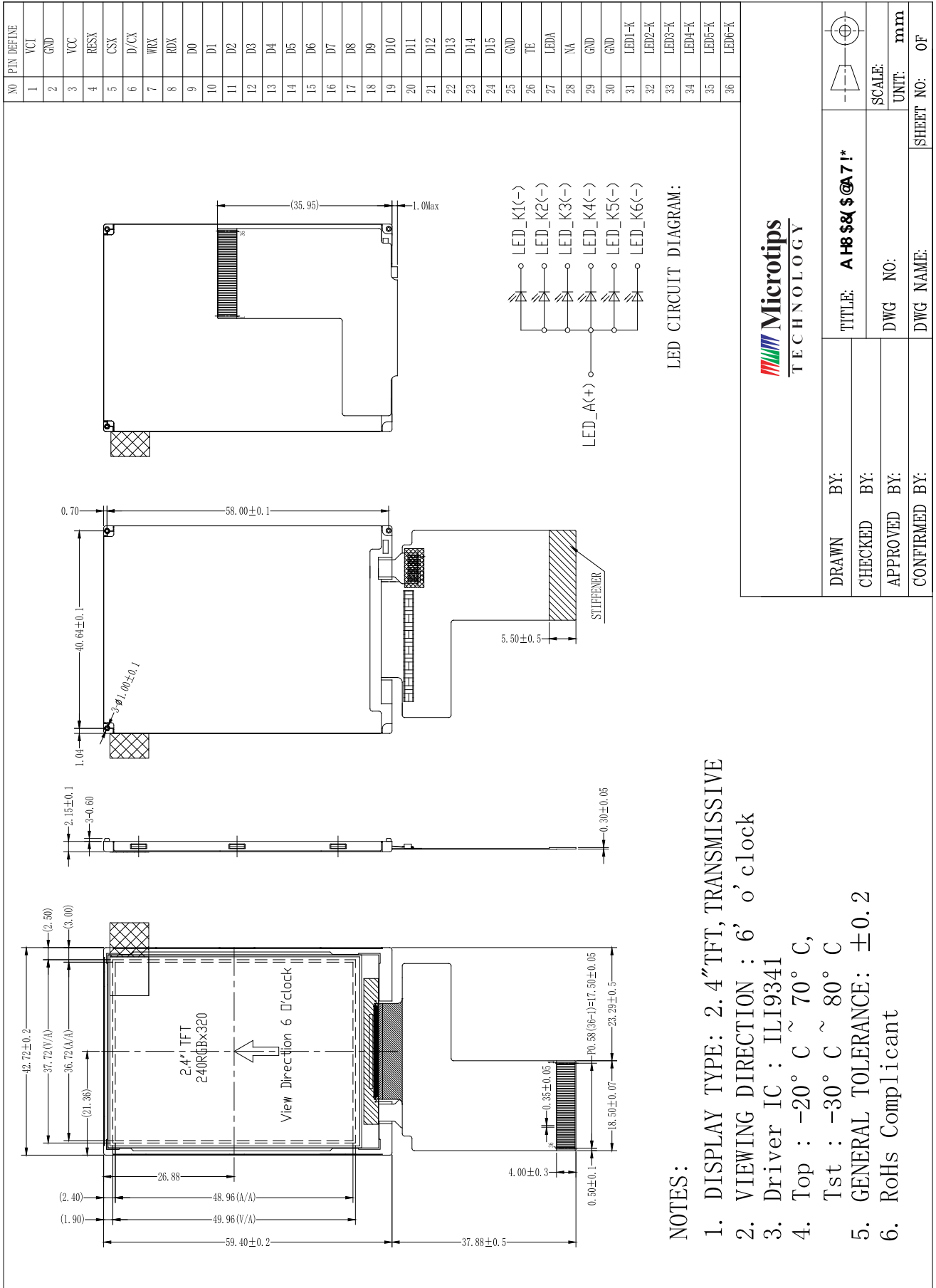

DRAWN BY:	TITLE: AH\$&@71*	DWG NO:	SCALE:
CHECKED BY:		DWG NAME:	UNIT: mm
APPROVED BY:			SHEET NO: OF
CONFIRMED BY:			

5. Interface signals

No	Symbol	I/O	Description	Remarks
1	VCI	P	Power supply for logic circuit	
2	GND	P	Ground	
3	VCC	P	Power supply for analog	
4	RESX	I	This signal will reset the device and must be applied to properly initialize the chip. Signal is active low.	
5	CSX	I	Chip select input pin ("Low" enable)	
6	D/CX	I	This pin is used to select data or command	
7	WRX	I	Serves as a write signal and writes data at the rising edge.	
8	RDX	I	Serves as a write signal and writes data at the rising edge	
9~24	D0~D15	I/O	Data bus pin	
25	GND	P	Ground	
26	TE	O	Tearing effect output pin to synchronize MPU to frame writing	
27	LEDA	P	Power supply for LED	
28	NA	-	No connection	
29	GND	P	Ground	
30	GND	P	Ground	
31~36	LED1-K~ LED6-K	P	LED cathode	

Note 1: P ---- Power; I ---- Input; O ---- Output.

Note 2: Recommend connector: FH12-36S-0.5SH

6. Absolute maximum Ratings

6.1. Electrical Absolute max. ratings

Parameter	Symbol	MIN	MAX	Unit	Remark
Logic Supply Voltage	VCI	-0.3	4.6	V	
Analog Supply Voltage	VCC	-0.3	4.6	V	
Input Voltage	CS/RS/WR/RD/D0~D17 RESX,CS,WR,RD	-0.3	IOVCC+0.3	V	
Backlight Forward Current	If	-	25	mA	One LED

6.2. Environment Conditions

Item	Symbol	MIN	MAX	Unit	Remark
Operating Temperature	TOPR	-20	70	°C	
Storage Temperature	TSTG	-30	80	°C	

6.3 Backlight LED

Item	Symbol	MIN	MAX	Unit	Remark
Forward current	ILED	-	25	mA	

7. Electrical Specifications

7.1 Electrical characteristics

GND=0V, Ta=25°C

Item	Symbol	MIN	TYP	MAX	Unit	Remark
Logic supply voltage	VCI	1.65	3.3	3.63	V	
Analog supply voltage	VCC	2.3	3.3	3.63	V	
Input Signal Voltage	VIL	--	--	0.3xIOVCC	V	CS/RS/WR/RD/D0 ~D17 RES,NS,WR,RD
	VIH	0.7xIOVCC	--	IOVCC	V	
Output Signal Voltage	VOL	--	--	0.2xIOVCC	V	
	VOH	0.8xIOVCC	--	--	V	
(Panel + LSI) Power Consumption	Black mode	-	30	45	mW	Sleep mode
	Sleeping mode	-	95	142.5	uW	

7.2 LED Backlight

Ta=25°C

Item	Symbol	MIN	TYP	MAX	Unit	Remark
Forward Current	IF	--	20	--	mA	
Forward Voltage	VF	(2.8)	3.2	(3.4)	V	
Backlight Power Consumption	WBL	--	384	--	mW	For reference

Note: The figure below shows the connection of backlight LED.

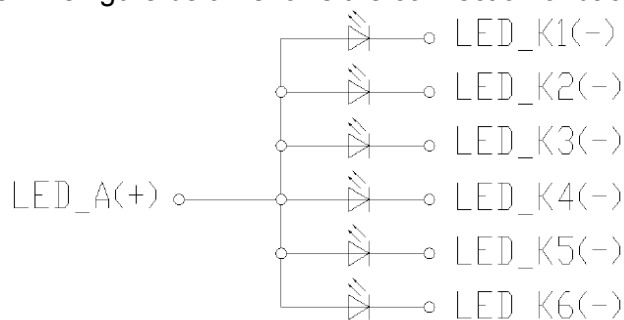

LED connection for Backlight 6 LED in Parallel.

7.3 Schematic of LCD module system

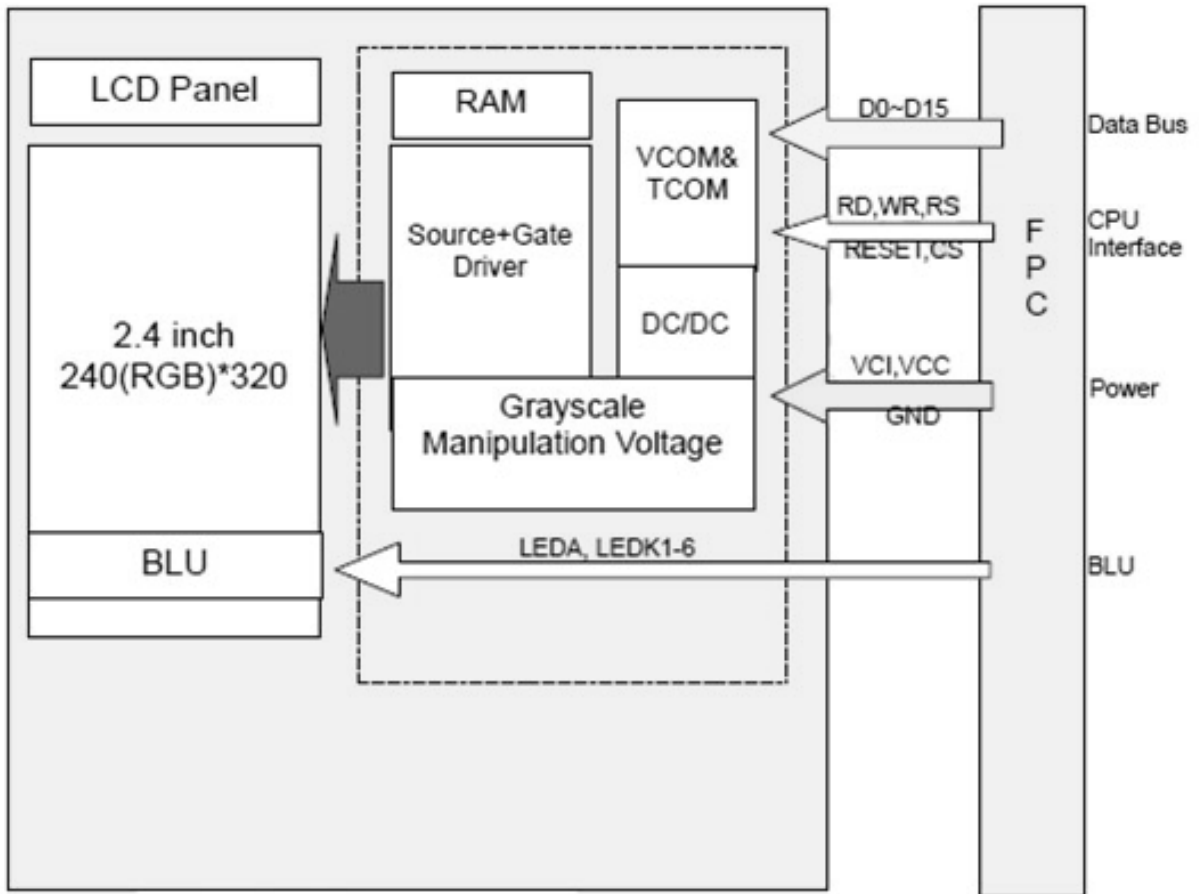

8 Command/AC Timing

8.1 Parallel (CPU18/16 bit) interface timing characteristics

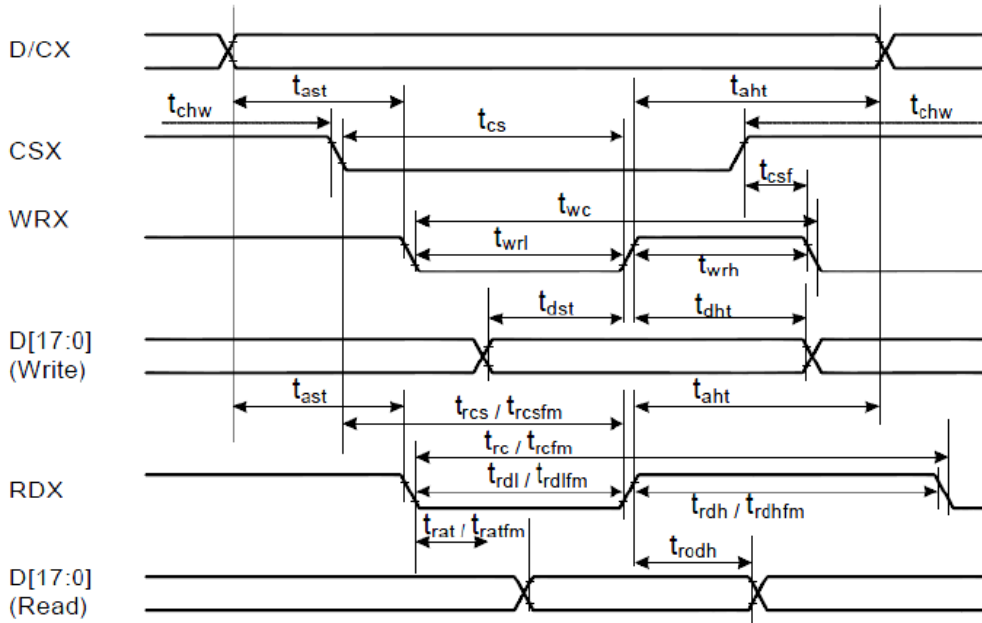

Figure 8.1 Parallel (CPU18/16 bit) interface characteristics

Signal	Symbol	Parameter	Min	Max	Unit	Description
DCX	Tast	Address setup time	0	-	ns	
	Taht	Address hold time (write/read)	0	-	ns	
CSX	Tchw	CSX "H" pulse width	0	-	ns	
	Tcs	Chip select setup time (Write)	15	-	ns	
	Trcs	Chip select setup time (Read ID)	45	-	ns	
	Trcsfm	Chip select setup time (Read FM)	355	-	ns	
	Tcsf	Chip select wait time (Write/Read)	10	-	ns	
WRX	Twc	Write cycle	66	-	ns	
	Twrh	Write control pulse H duration	15	-	ns	
	Twrl	Write control pulse duration	15	-	ns	
RDX(FM)	Trcfm	Read cycle (FM)	450	-	ns	
	Trdhfm	Read control H duration(FM)	90	-	ns	
	Trdlfm	Read control L duration(FM)	355	-	ns	
RDX(ID)	Trc	Read cycle (ID)	160	-	ns	
	Trdh	Read control pulse H duration	90	-	ns	
	Trdl	Read control pulse L duration	45	-	ns	
D[17:0] D[17:10]&[8:1] D[17:10] D[17:9]	Tdst	Write data setup time	10	-	ns	For maximum CL =30pF For minimum = 8 pF
	Tdht	Write data hold time	10	-	ns	
	Trat	Read access time	-	40	ns	
	Tratfm	Read access time	-	340	ns	
	trod	Read output disable time	20	80	ns	

Table 8.1 Parallel (CPU 18/ 16bit) interface parameter

8.2 Parallel (CPU 18/16 bit) write/read to register or GRAM

The following figure shows a write cycle for the 8080-I MCU interface

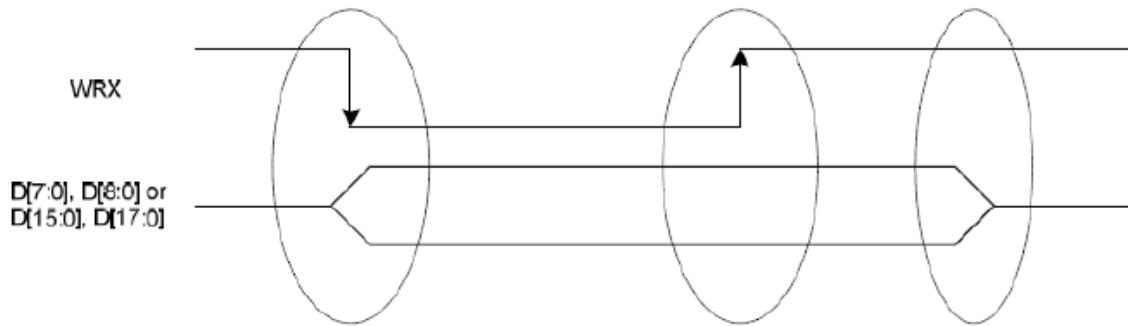

The host asserts D[17:0], D[15:0],D[8:0] or D[7:0] lines when there is falling edge of WRX

ILI9341 reads D[17:0] D[15:0],D[8:0] or D[7:0] when there is rising edge of WRX

The host negates D[17:0] D[15:0],D[8:0] or D[7:0] line

Note :WRX is an unsynchronized signal (it can be stopped)

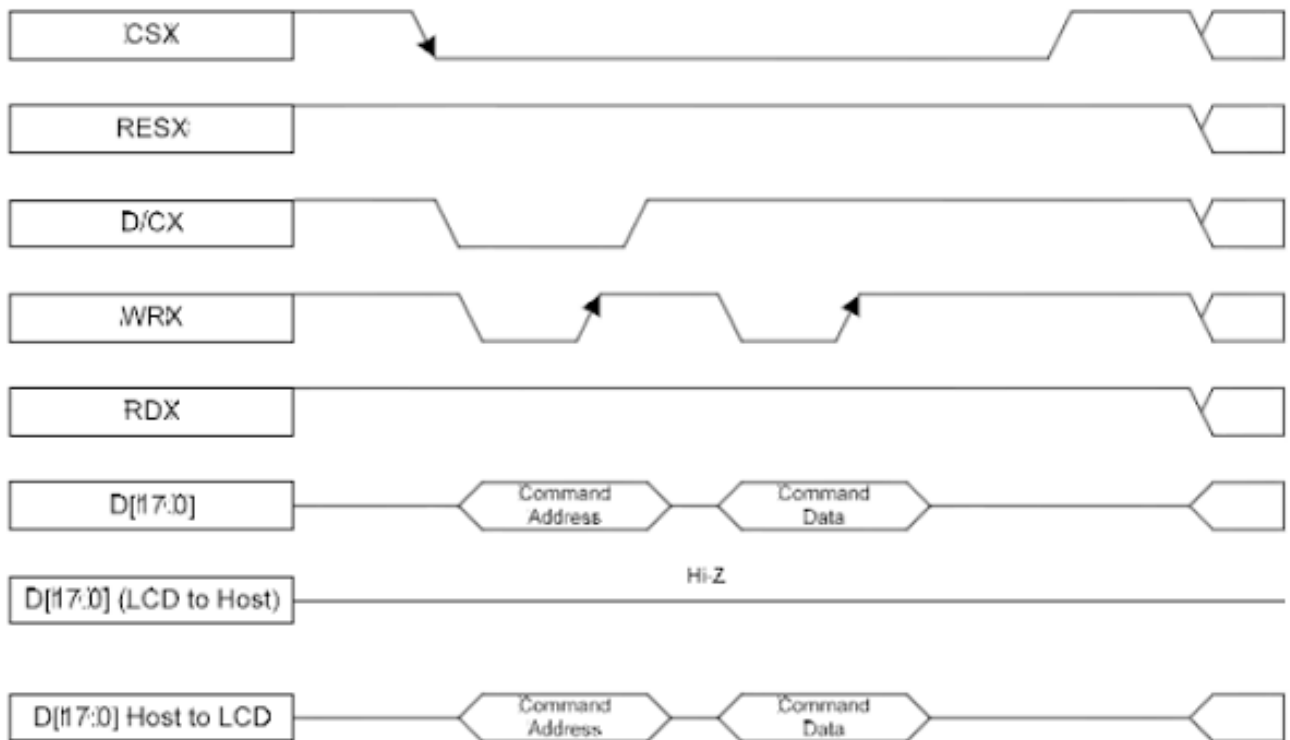
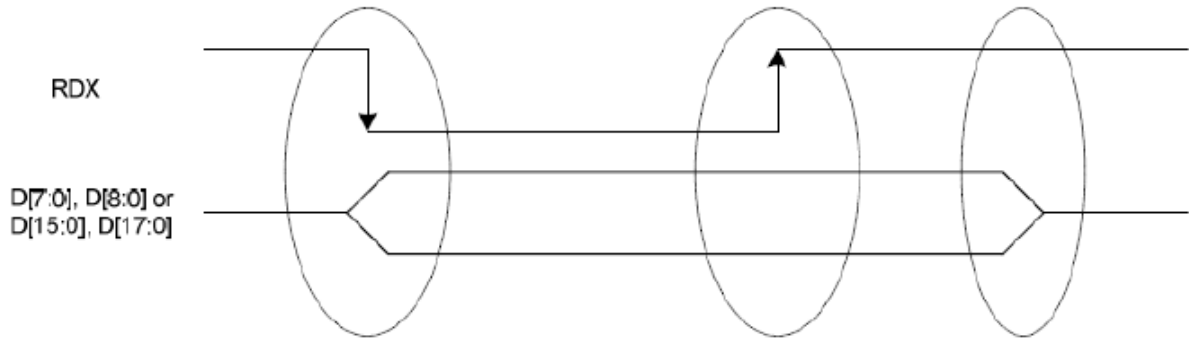

Figure 8.2.1 parallel (CPU 18/16 bit) write to register or GRAM

The following figure shows a read cycle for the 8080-I MCU interface



ILI9341 asserts D[17:0], D[15:0], D[8:0] or D[7:0] lines when there is falling edge of RDX

The host reads D[17:0] D[15:0], D[8:0] or D[7:0] when there is rising edge of RDX

The ILI9341 negates D[17:0] D[15:0], D[8:0] or D[7:0] lines

Note : RDX is an unsynchronized signal (It can be stopped)

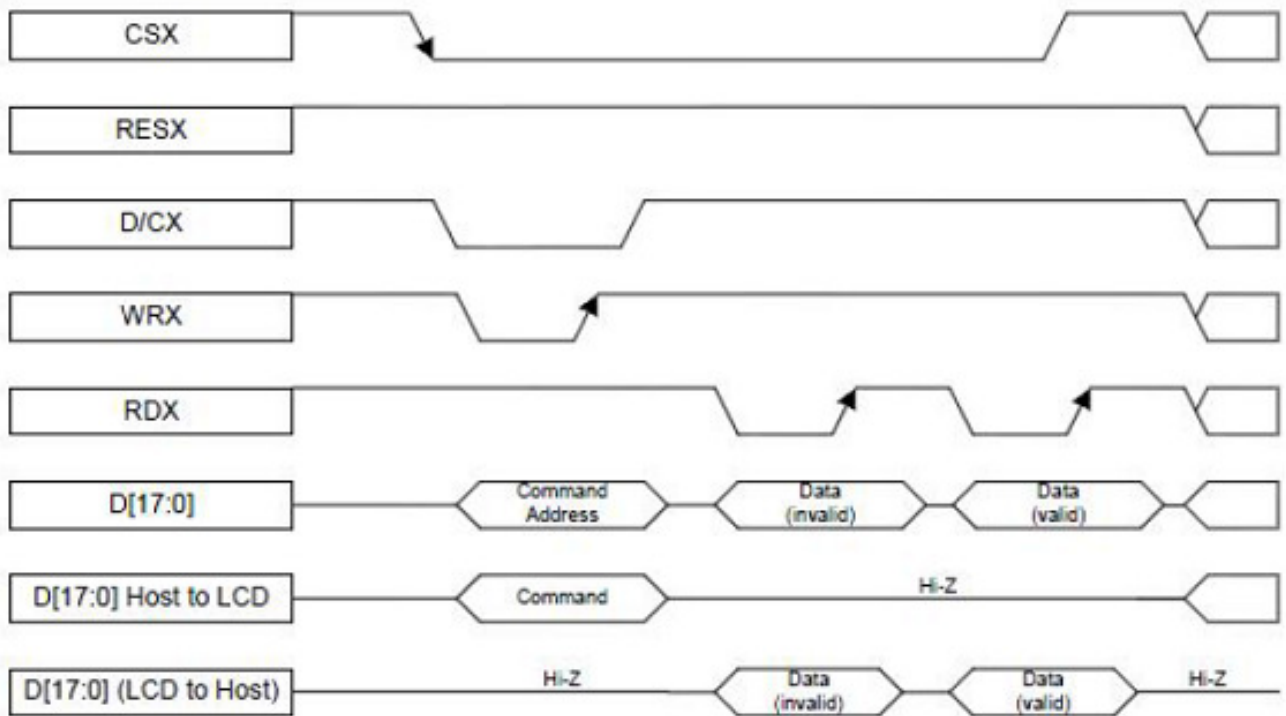

Figure 8.2.2 Parallel (CPU 18/16 bit) read to register or GRAM

8.3 Parallel (CPU 18/16 bit) Interface data color coding

65K color : 16-bit/pixel (RGB 5-6-5 bits input)

One pixel (3 sub-pixels) display data is sent by 1 transfer when DB[2:0] bits of 3Ah register are set to "101"

Count	0	1	2	3	...	238	239	240
D/CX	0	1	1	1	...	1	1	1
D15		0R4	1R4	2R4	...	237R4	238R4	239R4
D14		0R3	1R3	2R3	...	237R3	238R3	239R3
D13		0R2	1R2	2R2	...	237R2	238R2	239R2
D12		0R1	1R1	2R1	...	237R1	238R1	239R1
D11		0R0	1R0	2R0	...	237R0	238R0	239R0
D10		0G5	1G5	2G5	...	237G5	238G5	239G5
D9		0G4	1G4	2G4	...	237G4	238G4	239G4
D8		0G3	1G3	2G3	...	237G3	238G3	239G3
D7	C7	0G2	1G2	2G2	...	237G2	238G2	239G2
D6	C6	0G1	1G1	2G1	...	237G1	238G1	239G1
D5	C5	0G0	1G0	2G0	...	237G0	238G0	239G0
D4	C4	0B4	1B4	2B4	...	237B4	238B4	239B4
D3	C3	0B3	1B3	2B3	...	237B3	238B3	239B3
D2	C2	0B2	1B2	2B2	...	237B2	238B2	239B2
D1	C1	0B1	1B1	2B1	...	237B1	238B1	239B1
D0	C0	0B0	1B0	2B0	...	237B0	238B0	239B0

Table 8.3.1 65K color :16-bit display data

8.4 Power on/off sequence
Power on/off sequence

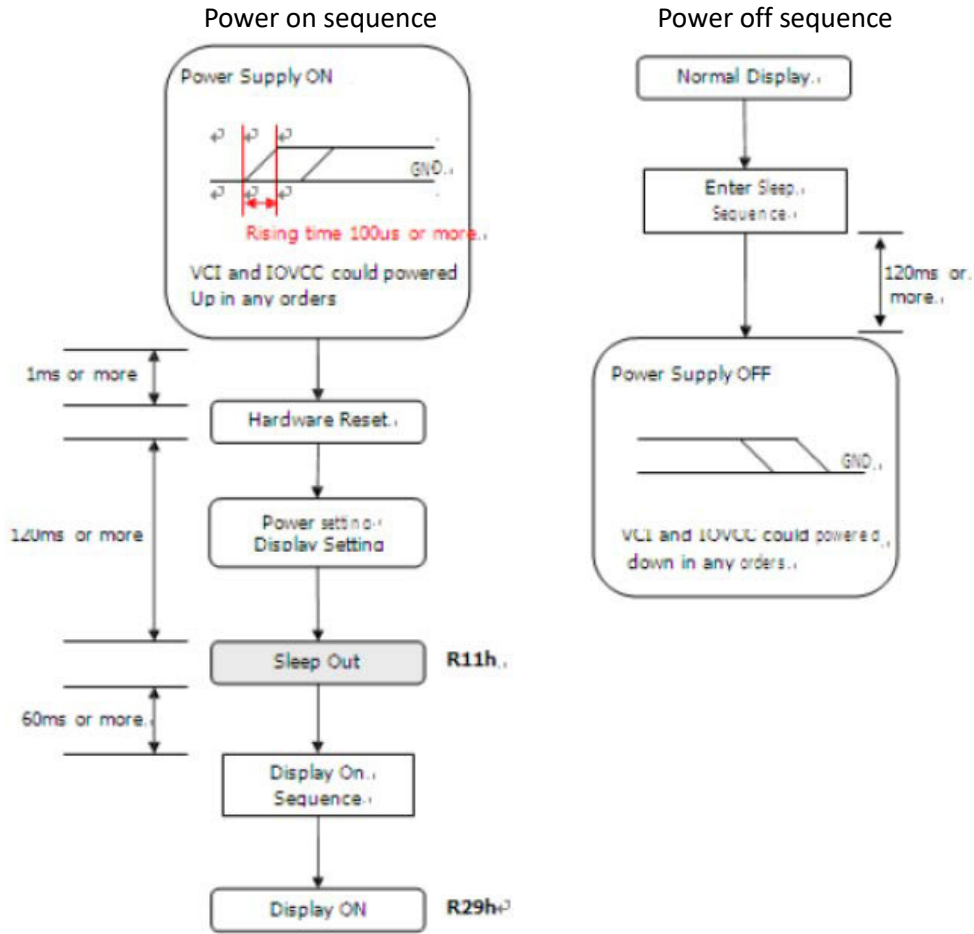

Note1: VCI: Logic power supply
VCC: Analog power supply

RESX line is hold high or unstable by host at power ON

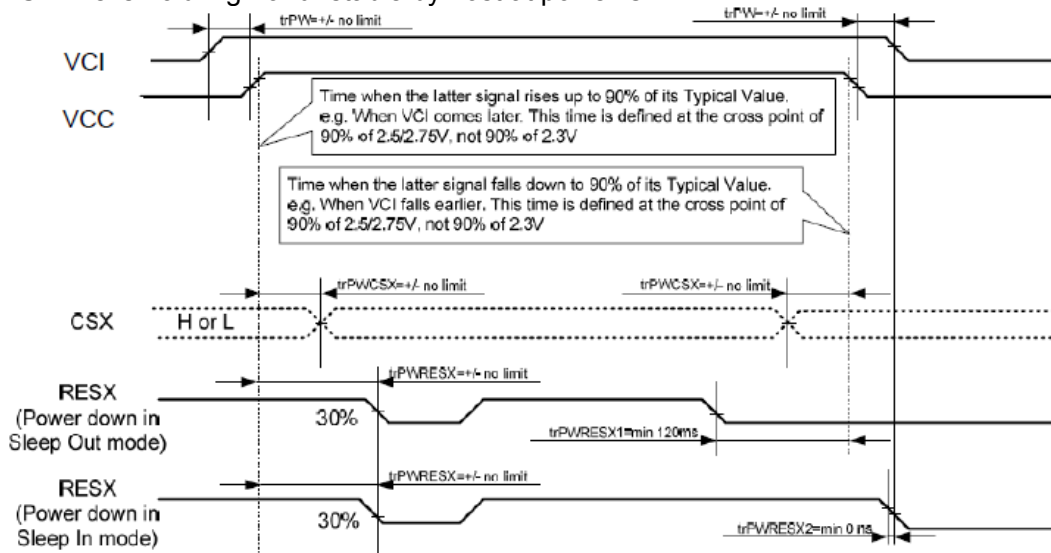

trPWRESX1 is applied to RESX falling in the sleep out mode
trPWRESX2 is applied to RESX falling in the sleep in mode

Note1: Unless otherwise specified, timings herein show cross point at 50% of signal power level.

Note2: VCI is logic power supply.

VCC is analog power supply.

8.5 Reset Timing

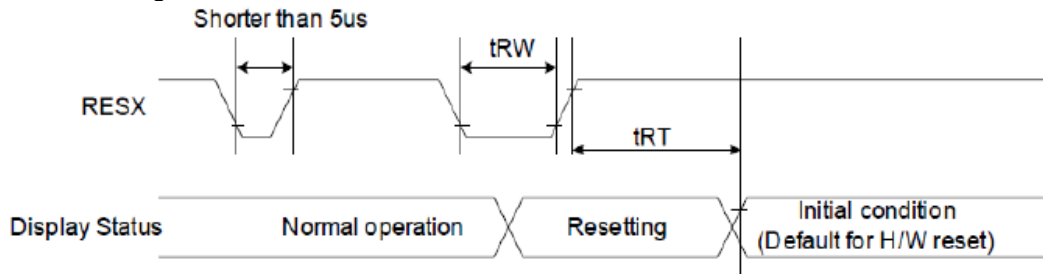

Signal	Symbol	Parameter	Min	Max	Unit
RESX	tRW	Reset pulse duration	10		us
	iRT	Reset cancel		5	ms
				120	ms

RESX Pulse	Action
Shorter than 5 us	Reset Rejected
Longer than 10 us	Reset
Between 5us and 10 us	Reset starts

8.6 Tearing Effect output

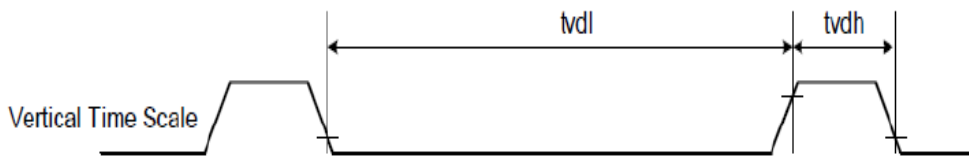

tvdh = The LCD display is not updated from the Frame Memory

tvdI = The LCD display is updated from the Frame Memory (except invisible line -see below)

AC characteristics of Tearing Effect Signal (Frame Rate = 60Hz)

Symbol	Parameter	Min	Typ	Max	Unit	Description
TvdI	Vertical timing low duration	--	--	--	ms	
tvdh	Vertical timing high duration	1000	--	--	us	

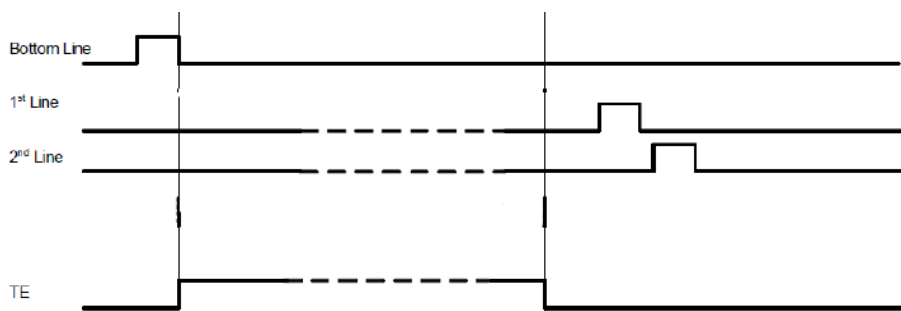

Note :

1. The timings in tables as above apply when MADCTL B4=0 and B4=1
2. The signal's rise and fall times (t_r , t_f) are stipulated to be equal to or less than 15ns.

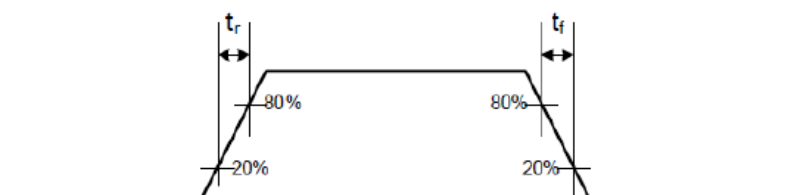

The tearing effect output line is fed back to the MCU and should be used to avoid tearing effect.

9 Optical Specification

Ta=25°C

Item	Symbol	Condition	Min	Typ.	Max.	Unit	Remark
Contrast Ratio	CR	$\theta=0^\circ$	400	500	-		Note1 Note3
Response Time	Tr + Tf	25°C	-	20	30	ms	Note1 Note4
View Angles	θT	$CR \geq 10$	60	70	-	Degree	Note 2
	θB		50	60	-		
	θL		60	70	-		
	θR		60	70	-		
Chromaticity	White	x	Backlight is on	Typ-0.05	Typ+0.05		Note 1 Note 5
		y					
	Red	x					
		y					
	Green	x					
		y					
	Blue	x					
		y					
NTSC	S		-	50	-	%	Note 5
Luminance	L		600	800	-	cd/m2	Note1 Note6
Uniformity	U		75	80	-	%	Note1 Note7

Test condition: IF= 20mA (LED current), VF=19.2V, the ambient temperature is 25 °C.

Note 1: Definition of optical measurement system.

Temperature = 25°C(±3°C)

LED back-light: ON, Environment brightness < 150 lx

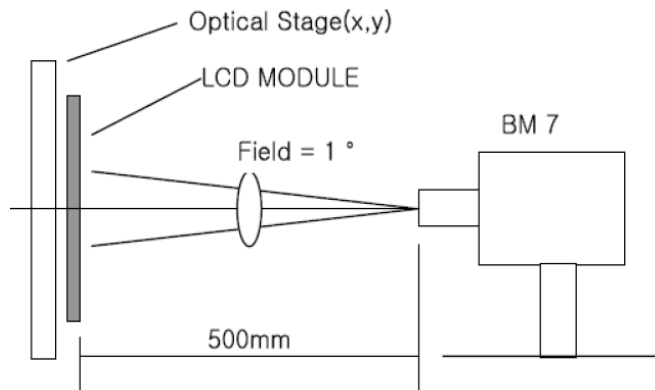

Note 2: Contrast ratio is defined as follow:

$$\text{Contrast Ratio} = \frac{\text{Surface Luminance with all white pixels}}{\text{Surface Luminance with all black pixels}}$$

Note 3: Response time is defined as follow:

Response time is the time required for the display to transition from black to white (Rise Time, T_r) and from white to black (Decay Time, T_f).

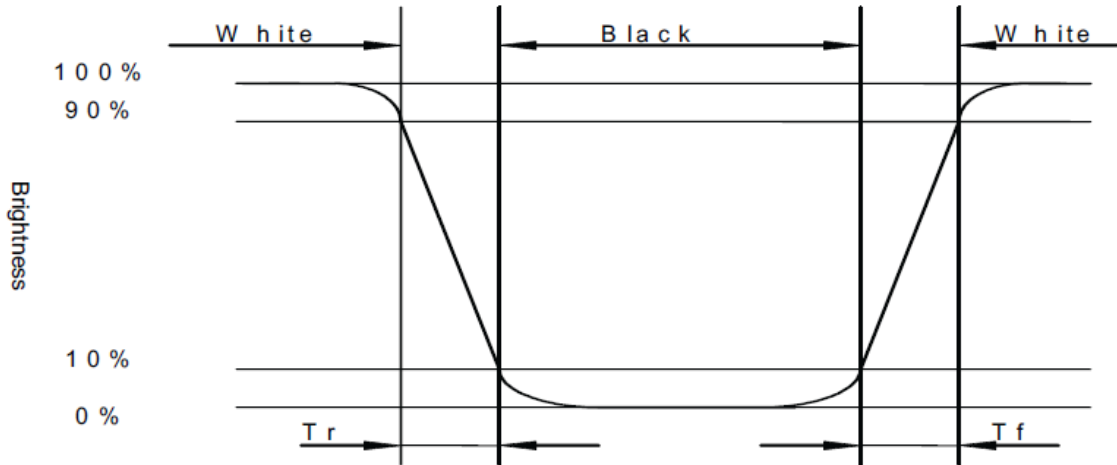

Note 4: Viewing angle range is defined as follow:

Viewing angle is measured at the center point of the LCD.

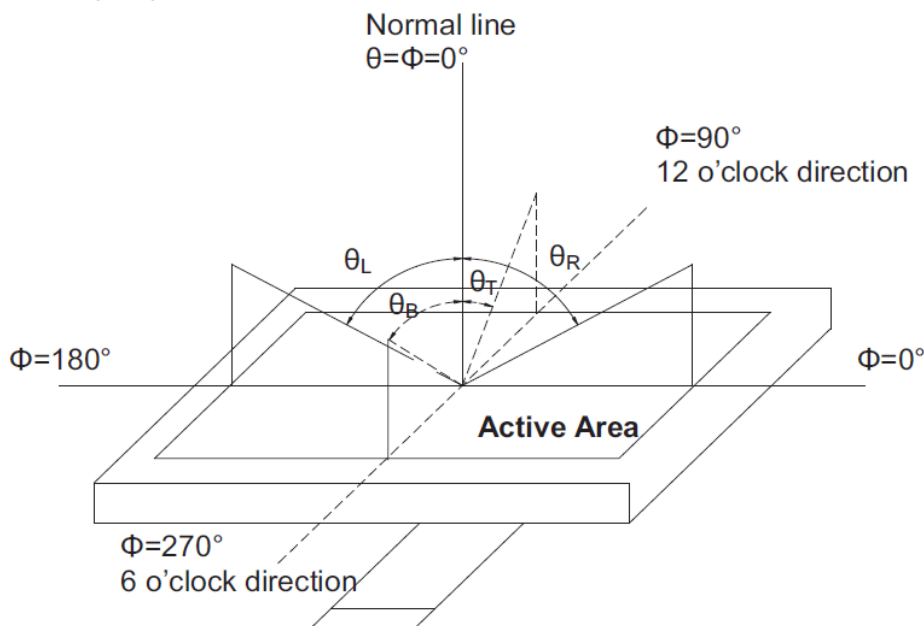

Note 5: Color chromaticity is defined as follow: (CIE1931)

Color coordinates measured at center point of LCD.

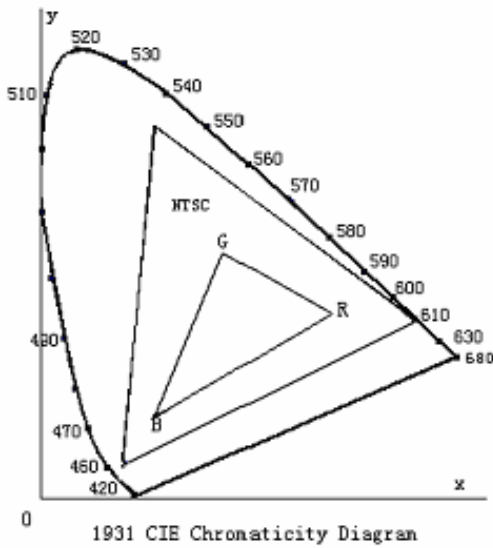

$$S = \frac{\text{area of RGB triangle}}{\text{area of NTSC triangle}} \times 100\%$$

Note 6: Luminance is defined as follow:

Luminance is defined as the brightness of all pixels “White” at the center of display area on optimum contrast.

Note 7: Luminance Uniformity is defined as follow:

Active area is divided into 9 measuring areas (Refer Fig. 2). Every measuring point is placed at the center of each measuring area.

$$\text{Uniformity}(U) = \frac{\text{Minimum Luminance(brightness) in 9 points}}{\text{Maximum Luminance(brightness) in 9 points}}$$

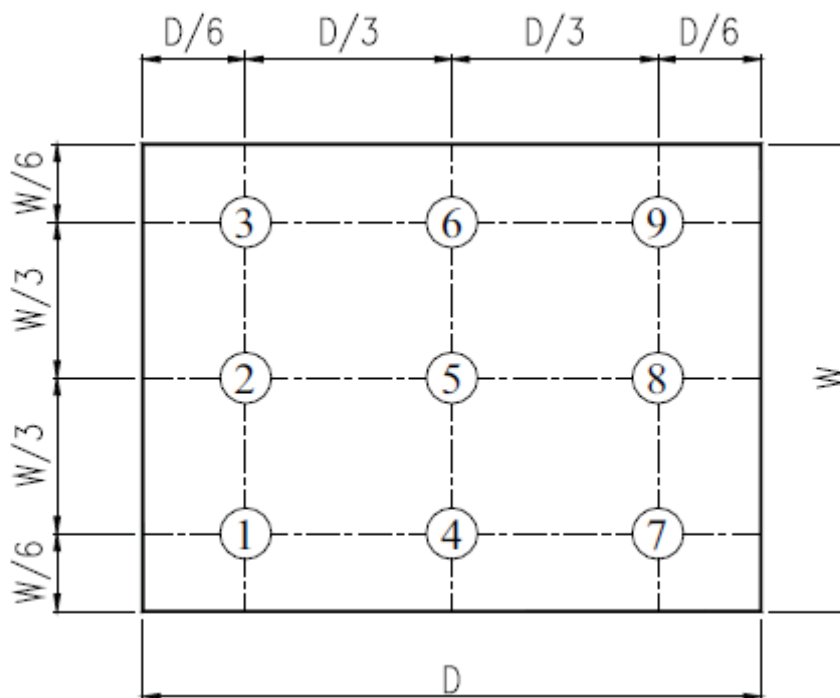

Fig. 2 Definition of uniformity

10 Environmental / Reliability Tests

No	Test Item	Condition	Judgment criteria
1	High Temp Operation	Ts=+70°C, 120hrs	Per table in below
2	Low Temp Operation	Ta=-20 °C, 120hrs	Per table in below
3	High Temp Storage	Ta=+80°C, 120hrs	Per table in below
4	Low Temp Storage	Ta=-30 °C, 120hrs	Per table in below
5	High Temp & High Humidity Storage	Ta=+60°C, 90% RH 120 hours	Per table in below (polarizer discoloration is excluded)
6	Thermal Shock (Non-operation)	-30°C 30 min~+80°C 30 min, Change time:5min, 10 Cycles	Per table in below
7	ESD (Operation)	C=150pF, R=330Ω · 5points/panel Air:±8KV, 5times; Contact:±4KV, 5 times;	Per table in below
8	Vibration (Non-operation)	Frequency range:10~55Hz, Stroke:1.5mm Sweep:10Hz~55Hz~10Hz 2 hours for each direction of X.Y.Z.	Per table in below
9	Shock (Non-operation)	60G 6ms, ±X,±Y,±Z 3times, for each direction	Per table in below
10	Package Drop Test	Height:80 cm, 1 corner, 3 edges, 6 surfaces	Per table in below

INSPECTION	CRITERION(after test)
Appearance	No Crack on the FPC, on the LCD Panel
Alignment of LCD Panel	No Bubbles in the LCD Panel No other Defects of Alignment in Active area
Electrical current	Within device specifications
Function / Display	No Broken Circuit, No Short Circuit or No Black line No Other Defects of Display

11 Precautions for Use of LCD Modules

11.1 Safety

The liquid crystal in the LCD is poisonous. Do not put it in your mouth. If the liquid crystal touches your skin or clothes, wash it off immediately using soap and water.

11.2 Handling

- A. The LCD and touch panel is made of plate glass. Do not subject the panel to mechanical shock or to excessive force on its surface.
- B. Do not handle the product by holding the flexible pattern portion in order to assure the reliability
- C. Transparency is an important factor for the touch panel. Please wear clear finger sacks, gloves and mask to protect the touch panel from finger print or stain and also hold the portion outside the view area when handling the touch panel.
- D. Provide a space so that the panel does not come into contact with other components.
- E. To protect the product from external force, put a covering lens (acrylic board or similar board) and keep an appropriate gap between them.
- F. Transparent electrodes may be disconnected if the panel is used under environmental conditions where dew condensation occurs.
- G. Property of semiconductor devices may be affected when they are exposed to light, possibly resulting in IC malfunctions.
- H. To prevent such IC malfunctions, your design and mounting layout shall be done in the way that the IC is not exposed to light in actual use.

11.3 Static Electricity

- A. Ground soldering iron tips, tools and testers when they are in operation.
- B. Ground your body when handling the products.
- C. Power on the LCD module before applying the voltage to the input terminals.
- D. Do not apply voltage which exceeds the absolute maximum rating.
- E. Store the products in an anti-electrostatic bag or container.

11.4 Storage

- A. Store the products in a dark place at $+25^{\circ}\text{C} \pm 10^{\circ}\text{C}$ with low humidity (40% RH to 60% RH). Don't expose to sunlight or fluorescent light.
- B. Storage in a clean environment, free from dust, active gas, and solvent.

11.5 Cleaning

- A. Do not wipe the touch panel with dry cloth, as it may cause scratch.
- B. Wipe off the stain on the product by using soft cloth moistened with ethanol. Do not allow ethanol to get in between the upper film and the bottom glass. It may cause peeling issue or defective operation. Do not use any organic solvent or detergent other than ethanol.

11.6 Cautions for installing and assembling

Bezel edge must be positioned in the area between the Active area and View area. The bezel may press the touch screen and cause activation if the edge touches the active area. A gap of approximately 0.5mm is needed between the bezel and the top electrode. It may cause unexpected activation if the gap is too narrow. There is a tolerance of 0.2 to 0.3mm for the outside dimensions of the touch panel and tail. A gap must be made to absorb the tolerance in the case and connector.

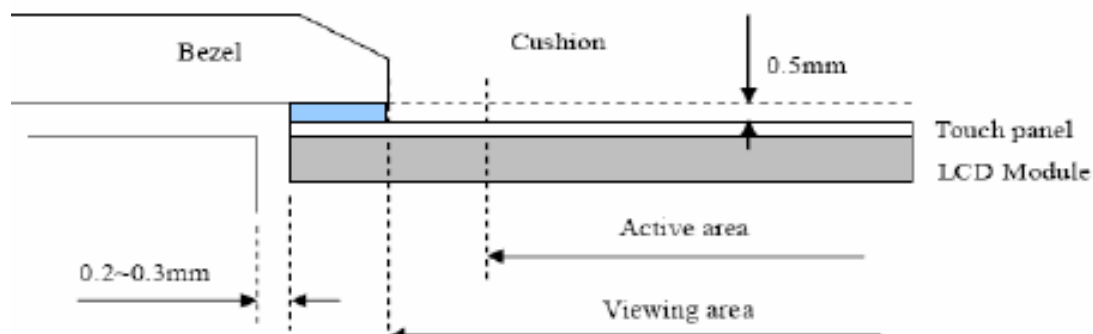



Компания «ЭлектроПласт» предлагает заключение долгосрочных отношений при поставках импортных электронных компонентов на взаимовыгодных условиях!

Наши преимущества:

- Оперативные поставки широкого спектра электронных компонентов отечественного и импортного производства напрямую от производителей и с крупнейших мировых складов;
- Поставка более 17-ти миллионов наименований электронных компонентов;
- Поставка сложных, дефицитных, либо снятых с производства позиций;
- Оперативные сроки поставки под заказ (от 5 рабочих дней);
- Экспресс доставка в любую точку России;
- Техническая поддержка проекта, помощь в подборе аналогов, поставка прототипов;
- Система менеджмента качества сертифицирована по Международному стандарту ISO 9001;
- Лицензия ФСБ на осуществление работ с использованием сведений, составляющих государственную тайну;
- Поставка специализированных компонентов (Xilinx, Altera, Analog Devices, Intersil, Interpoint, Microsemi, Aeroflex, Peregrine, Syfer, Eurofarad, Texas Instrument, Miteq, Cobham, E2V, MA-COM, Hittite, Mini-Circuits, General Dynamics и др.);

Помимо этого, одним из направлений компании «ЭлектроПласт» является направление «Источники питания». Мы предлагаем Вам помощь Конструкторского отдела:

- Подбор оптимального решения, техническое обоснование при выборе компонента;
- Подбор аналогов;
- Консультации по применению компонента;
- Поставка образцов и прототипов;
- Техническая поддержка проекта;
- Защита от снятия компонента с производства.



Как с нами связаться

Телефон: 8 (812) 309 58 32 (многоканальный)

Факс: 8 (812) 320-02-42

Электронная почта: org@eplast1.ru

Адрес: 198099, г. Санкт-Петербург, ул. Калинина, дом 2, корпус 4, литера А.