

# NCV8403, NCV8403A

## Self-Protected Low Side Driver with Temperature and Current Limit

42 V, 14 A, Single N-Channel, SOT-223

NCV8403/A is a three terminal protected Low-Side Smart Discrete device. The protection features include overcurrent, overtemperature, ESD and integrated Drain-to-Gate clamping for overvoltage protection. This device offers protection and is suitable for harsh automotive environments.

### Features

- Short Circuit Protection
- Thermal Shutdown with Automatic Restart
- Over Voltage Protection
- Integrated Clamp for Inductive Switching
- ESD Protection
- dV/dt Robustness
- Analog Drive Capability (Logic Level Input)
- AEC-Q101 Qualified and PPAP Capable
- NCV Prefix for Automotive and Other Applications Requiring Unique Site and Control Change Requirements
- These Devices are Pb-Free and are RoHS Compliant

### Typical Applications

- Switch a Variety of Resistive, Inductive and Capacitive Loads
- Can Replace Electromechanical Relays and Discrete Circuits
- Automotive / Industrial



ON Semiconductor®

<http://onsemi.com>

V <sub>DSS</sub> (Clamped)	R <sub>DS(on)</sub> TYP	I <sub>D</sub> MAX (Limited)
42 V	53 mΩ @ 10 V	15 A

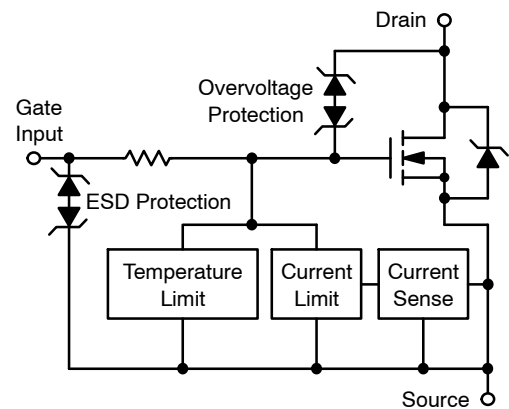

### MARKING DIAGRAM

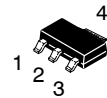

SOT-223  
CASE 318E  
STYLE 3

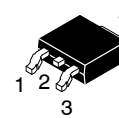

DPAK  
CASE 369C

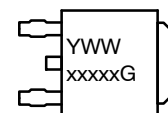
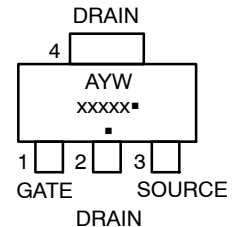

A = Assembly Location

Y = Year

W, WW = Work Week

xxxxx = V8403 or 8403A

G or ■ = Pb-Free Package

(Note: Microdot may be in either location)

### ORDERING INFORMATION

See detailed ordering and shipping information in the package dimensions section on page 10 of this data sheet.

# NCV8403, NCV8403A

## MAXIMUM RATINGS ( $T_J = 25^\circ\text{C}$ unless otherwise noted)

Rating	Symbol	Value	Unit
Drain-to-Source Voltage Internally Clamped	$V_{DSS}$	42	Vdc
Gate-to-Source Voltage	$V_{GS}$	$\pm 14$	Vdc
Drain Current      Continuous	$I_D$	Internally Limited	
Total Power Dissipation @ $T_A = 25^\circ\text{C}$ (Note 1) @ $T_A = 25^\circ\text{C}$ (Note 2)	$P_D$	1.13 1.56	W
Thermal Resistance – SOT-223 Version Junction-to-Case Junction-to-Ambient (Note 1) Junction-to-Ambient (Note 2) Thermal Resistance – DPAK Version Junction-to-Case Junction-to-Ambient (Note 1) Junction-to-Ambient (Note 2)	$R_{\theta JC}$ $R_{\theta JA}$ $R_{\theta JA}$ $R_{\theta JC}$ $R_{\theta JA}$ $R_{\theta JA}$	12 110 80 2.5 95 50	$^\circ\text{C/W}$
Single Pulse Inductive Load Switching Energy ( $V_{DD} = 25\text{ Vdc}$ , $V_{GS} = 5.0\text{ V}$ , $I_L = 2.8\text{ A}$ , $L = 120\text{ mH}$ , $R_G = 25\ \Omega$ )	$E_{AS}$	470	mJ
Load Dump Voltage ( $V_{GS} = 0$ and $10\text{ V}$ , $R_I = 2.0\ \Omega$ , $R_L = 4.5\ \Omega$ , $t_d = 400\text{ ms}$ )	$V_{LD}$	55	V
Operating Junction Temperature	$T_J$	-40 to 150	$^\circ\text{C}$
Storage Temperature	$T_{stg}$	-55 to 150	$^\circ\text{C}$

Stresses exceeding Maximum Ratings may damage the device. Maximum Ratings are stress ratings only. Functional operation above the Recommended Operating Conditions is not implied. Extended exposure to stresses above the Recommended Operating Conditions may affect device reliability.

1. Surface mounted onto minimum pad size (0.412" square) FR4 PCB, 1 oz cu.
2. Mounted onto 1" square pad size (1.127" square) FR4 PCB, 1 oz cu.

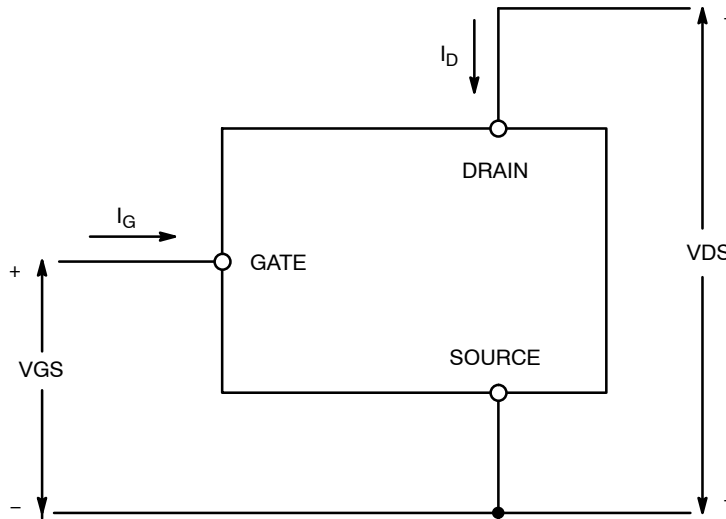

**Figure 1. Voltage and Current Convention**

# NCV8403, NCV8403A

## MOSFET ELECTRICAL CHARACTERISTICS (T<sub>J</sub> = 25°C unless otherwise noted)

Characteristic	Symbol	Min	Typ	Max	Unit
<b>OFF CHARACTERISTICS</b>					
Drain-to-Source Clamped Breakdown Voltage (V <sub>GS</sub> = 0 Vdc, I <sub>D</sub> = 250 μAdc) (V <sub>GS</sub> = 0 Vdc, I <sub>D</sub> = 250 μAdc, T <sub>J</sub> = -40°C to 150°C) (Note 3)	V <sub>(BR)DSS</sub>	42 40	46 45	51 51	Vdc Vdc
Zero Gate Voltage Drain Current (V <sub>DS</sub> = 32 Vdc, V <sub>GS</sub> = 0 Vdc) (V <sub>DS</sub> = 32 Vdc, V <sub>GS</sub> = 0 Vdc, T <sub>J</sub> = 150°C) (Note 3)	I <sub>DSS</sub>	- -	0.6 2.5	5.0 -	μAdc
Gate Input Current (V <sub>GS</sub> = 5.0 Vdc, V <sub>DS</sub> = 0 Vdc)	I <sub>GSS</sub>	-	50	125	μAdc

## ON CHARACTERISTICS

Gate Threshold Voltage (V <sub>DS</sub> = V <sub>GS</sub> , I <sub>D</sub> = 1.2 mA) Threshold Temperature Coefficient (Negative)	V <sub>GS(th)</sub>	1.0 -	1.7 5.0	2.2 -	Vdc mV/°C
Static Drain-to-Source On-Resistance (Note 4) (V <sub>GS</sub> = 10 Vdc, I <sub>D</sub> = 3.0 Adc, T <sub>J</sub> @ 25°C) (V <sub>GS</sub> = 10 Vdc, I <sub>D</sub> = 3.0 Adc, T <sub>J</sub> @ 150°C) (Note 3)	R <sub>DS(on)</sub>	- -	53 95	68 123	mΩ
Static Drain-to-Source On-Resistance (Note 4) (V <sub>GS</sub> = 5.0 Vdc, I <sub>D</sub> = 3.0 Adc, T <sub>J</sub> @ 25°C) (V <sub>GS</sub> = 5.0 Vdc, I <sub>D</sub> = 3.0 Adc, T <sub>J</sub> @ 150°C) (Note 3)	R <sub>DS(on)</sub>	- -	63 105	76 135	mΩ
Source-Drain Forward On Voltage (I <sub>S</sub> = 7.0 A, V <sub>GS</sub> = 0 V)	V <sub>SD</sub>	-	0.95	1.1	V

## SWITCHING CHARACTERISTICS (Note 3)

Turn-ON Time (10% V <sub>IN</sub> to 90% I <sub>D</sub> )	V <sub>IN</sub> = 0 V to 5 V, V <sub>DD</sub> = 25 V I <sub>D</sub> = 1.0 A, Ext R <sub>G</sub> = 2.5 Ω	t <sub>ON</sub>	44		μs
Turn-OFF Time (90% V <sub>IN</sub> to 10% I <sub>D</sub> )		t <sub>OFF</sub>	84		
Turn-ON Time (10% V <sub>IN</sub> to 90% I <sub>D</sub> )	V <sub>IN</sub> = 0 V to 10 V, V <sub>DD</sub> = 25 V, I <sub>D</sub> = 1.0 A, Ext R <sub>G</sub> = 2.5 Ω	t <sub>ON</sub>	15		μs
Turn-OFF Time (90% V <sub>IN</sub> to 10% I <sub>D</sub> )		t <sub>OFF</sub>	116		
Slew-Rate ON (20% V <sub>DS</sub> to 50% V <sub>DS</sub> )	V <sub>in</sub> = 0 to 10 V, V <sub>DD</sub> = 12 V, R <sub>L</sub> = 4.7 Ω	-dV <sub>DS</sub> /dt <sub>ON</sub>	2.43		V/μs
Slew-Rate OFF (80% V <sub>DS</sub> to 50% V <sub>DS</sub> )		dV <sub>DS</sub> /dt <sub>OFF</sub>	0.83		

## SELF PROTECTION CHARACTERISTICS (T<sub>J</sub> = 25°C unless otherwise noted) (Note 5)

Current Limit	V <sub>GS</sub> = 5.0 V, V <sub>DS</sub> = 10 V V <sub>GS</sub> = 5.0 V, T <sub>J</sub> = 150°C (Note 3)	I <sub>LIM</sub>	10 5.0	15 10	20 15	Adc
Current Limit	V <sub>GS</sub> = 10 V, V <sub>DS</sub> = 10 V V <sub>GS</sub> = 10 V, T <sub>J</sub> = 150°C (Note 3)	I <sub>LIM</sub>	12 8.0	17 13	22 18	Adc
Temperature Limit (Turn-off)	V <sub>GS</sub> = 5.0 Vdc (Note 3)	T <sub>LIM(off)</sub>	150	175	200	°C
Thermal Hysteresis	V <sub>GS</sub> = 5.0 Vdc	ΔT <sub>LIM(on)</sub>	-	15	-	°C
Temperature Limit (Turn-off)	V <sub>GS</sub> = 10 Vdc (Note 3)	T <sub>LIM(off)</sub>	150	165	185	°C
Thermal Hysteresis	V <sub>GS</sub> = 10 Vdc	ΔT <sub>LIM(on)</sub>	-	15	-	°C

## GATE INPUT CHARACTERISTICS (Note 3)

Device ON Gate Input Current	V <sub>GS</sub> = 5 V I <sub>D</sub> = 1.0 A	I <sub>GON</sub>		50		μA
	V <sub>GS</sub> = 10 V I <sub>D</sub> = 1.0 A			400		
Current Limit Gate Input Current	V <sub>GS</sub> = 5 V, V <sub>DS</sub> = 10 V	I <sub>GCL</sub>		0.1		mA
	V <sub>GS</sub> = 10 V, V <sub>DS</sub> = 10 V			0.6		
Thermal Limit Fault Gate Input Current	V <sub>GS</sub> = 5 V, V <sub>DS</sub> = 10 V	I <sub>GTL</sub>		0.45		mA
	V <sub>GS</sub> = 10 V, V <sub>DS</sub> = 10 V			1.5		

## ESD ELECTRICAL CHARACTERISTICS (T<sub>J</sub> = 25°C unless otherwise noted) (Note 3)

Electro-Static Discharge Capability	Human Body Model (HBM)	ESD	4000	-	-	V
Electro-Static Discharge Capability	Machine Model (MM)	ESD	400	-	-	V

3. Not subject to production testing.
4. Pulse Test: Pulse Width = 300 μs, Duty Cycle = 2%.
5. Fault conditions are viewed as beyond the normal operating range of the part.

TYPICAL PERFORMANCE CURVES

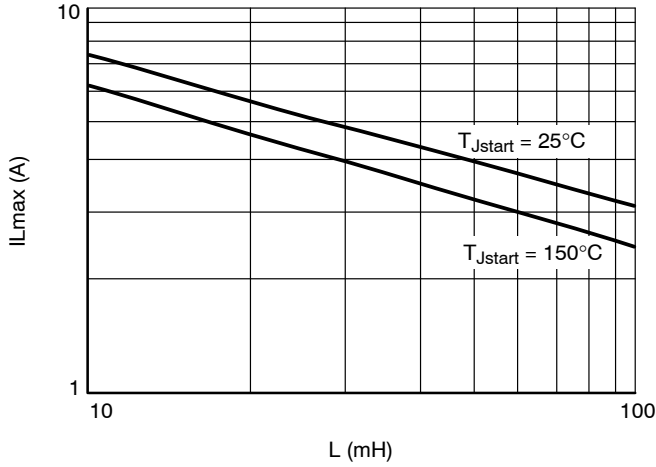

Figure 2. Single Pulse Maximum Switch-off Current vs. Load Inductance

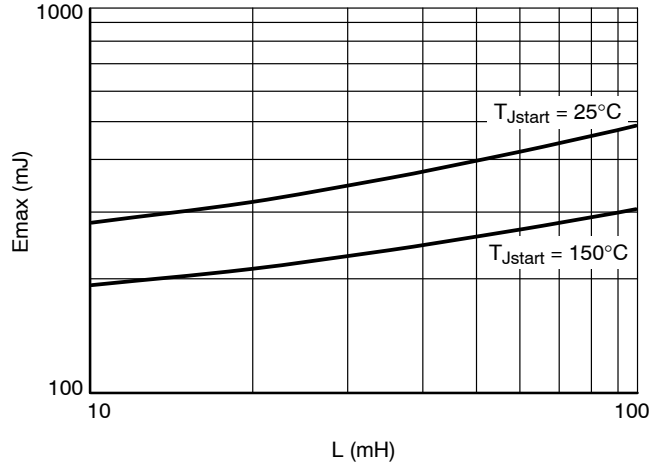

Figure 3. Single-Pulse Maximum Switching Energy vs. Load Inductance

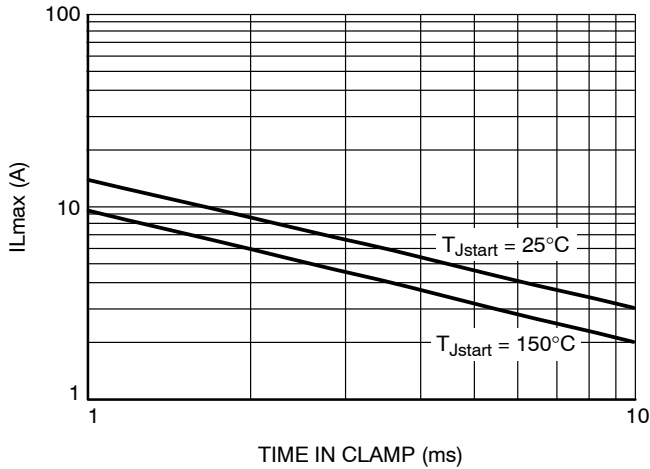

Figure 4. Single Pulse Maximum Inductive Switch-off Current vs. Time in Clamp

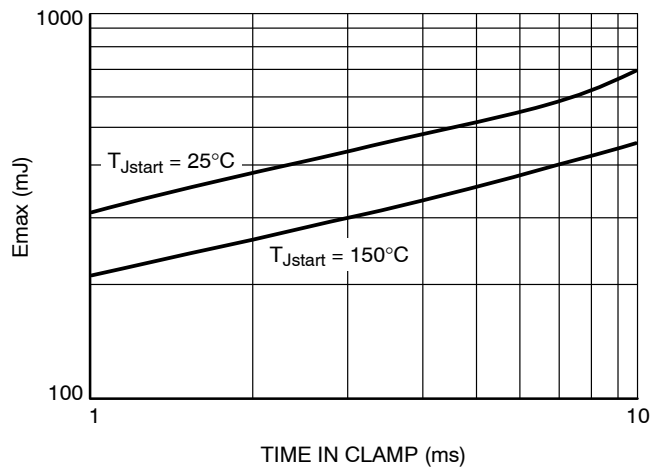

Figure 5. Single-Pulse Maximum Inductive Switching Energy vs. Time in Clamp

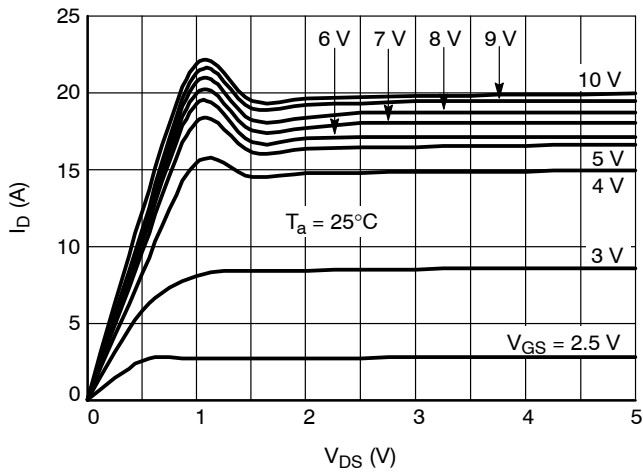

Figure 6. On-state Output Characteristics

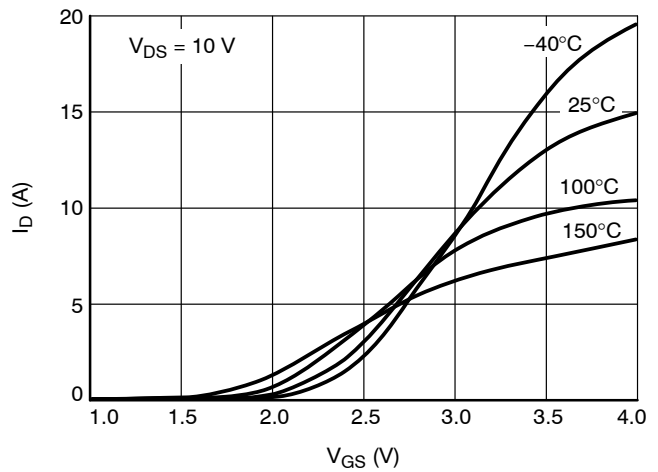

Figure 7. Transfer Characteristics

# NCV8403, NCV8403A

## TYPICAL PERFORMANCE CURVES

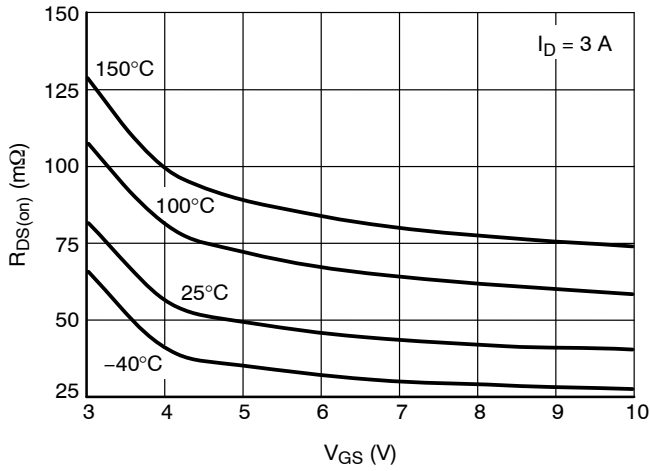

Figure 8.  $R_{DS(on)}$  vs. Gate-Source Voltage

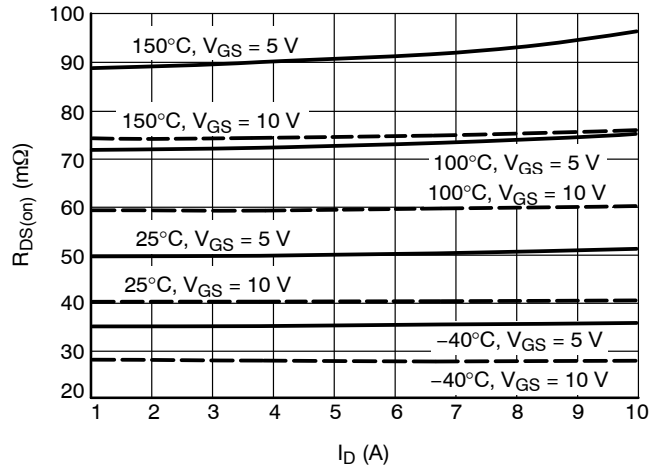

Figure 9.  $R_{DS(on)}$  vs. Drain Current

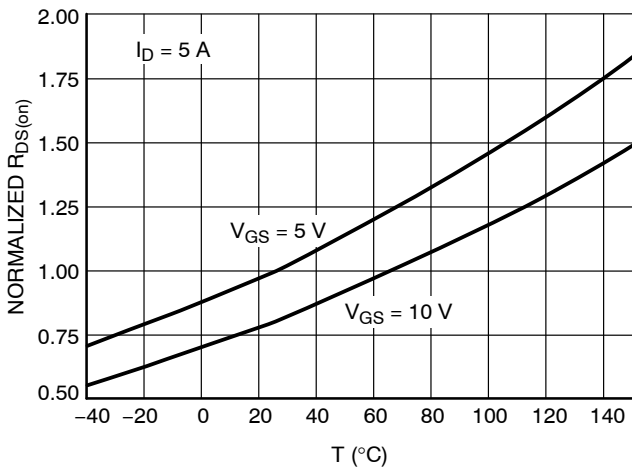

Figure 10. Normalized  $R_{DS(on)}$  vs. Temperature

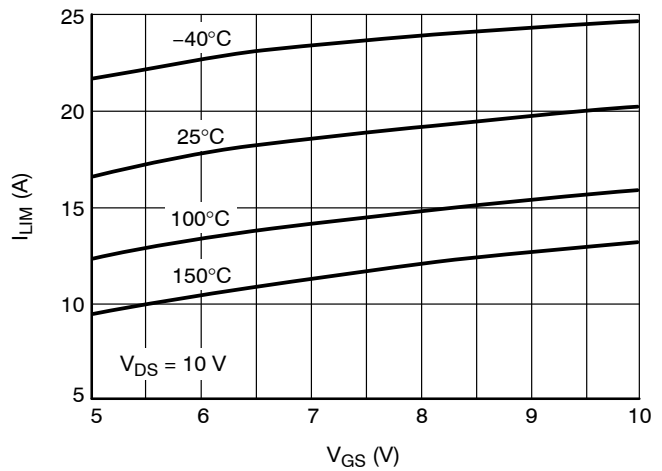

Figure 11. Current Limit vs. Gate-Source Voltage

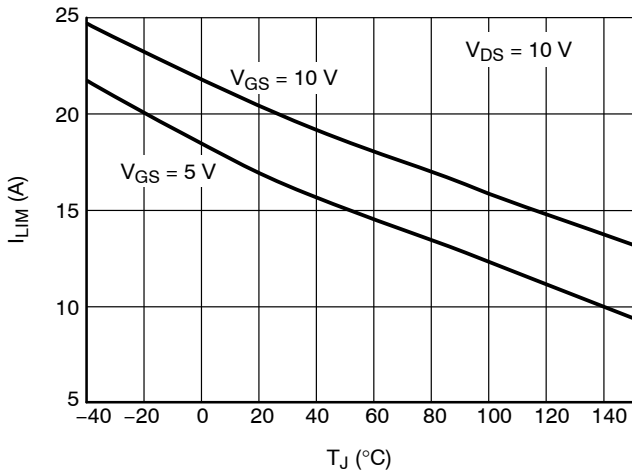

Figure 12. Current Limit vs. Junction Temperature

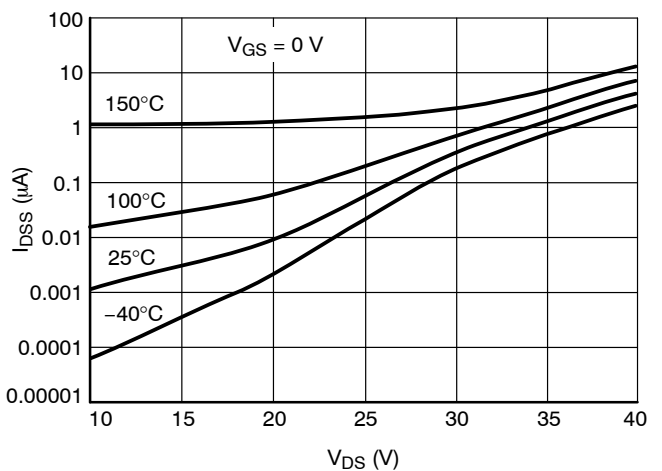

Figure 13. Drain-to-Source Leakage Current

TYPICAL PERFORMANCE CURVES

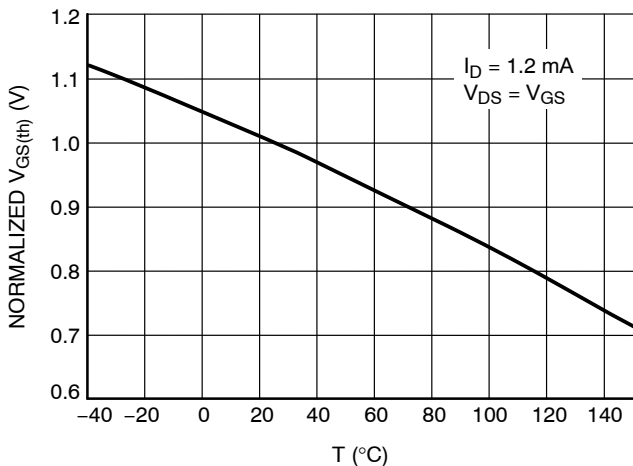

Figure 14. Normalized Threshold Voltage vs. Temperature

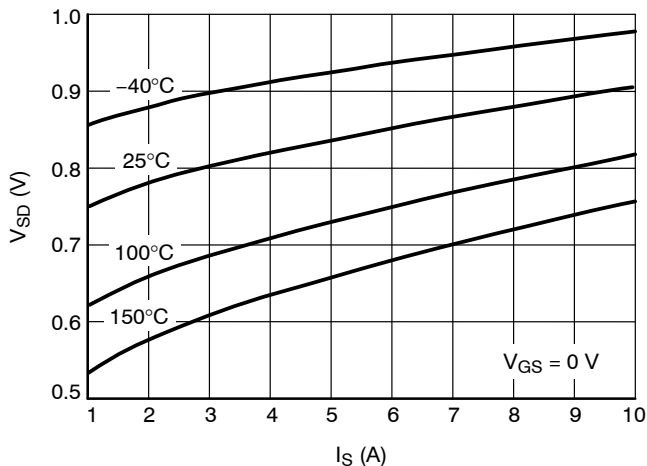

Figure 15. Source-Drain Diode Forward Characteristics

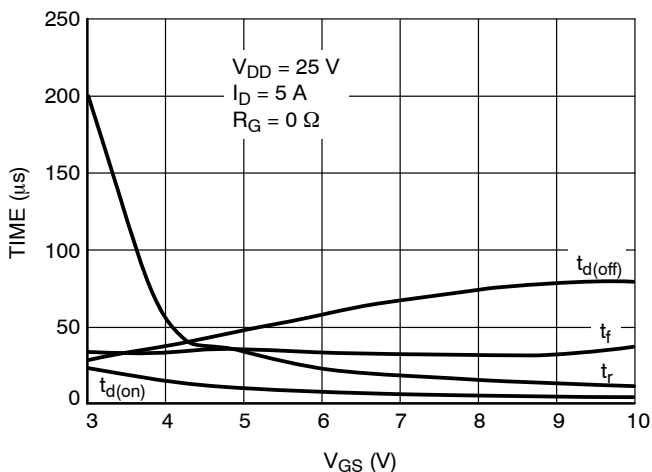

Figure 16. Resistive Load Switching Time vs. Gate-Source Voltage

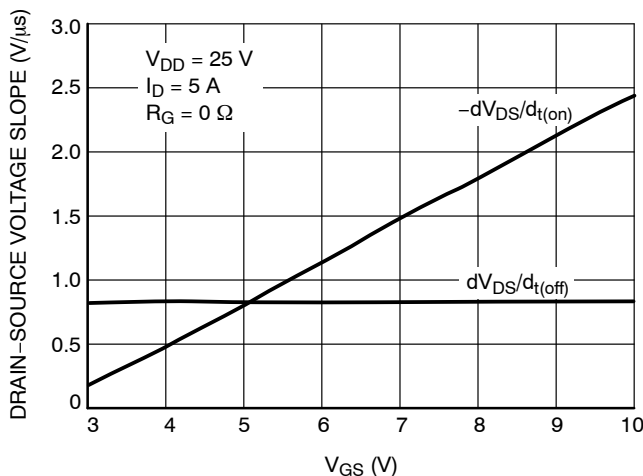

Figure 17. Resistive Load Switching Drain-Source Voltage Slope vs. Gate-Source Voltage

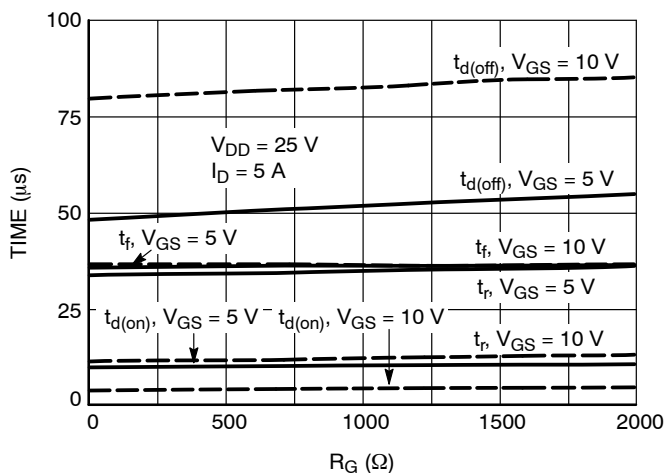

Figure 18. Resistive Load Switching Time vs. Gate Resistance

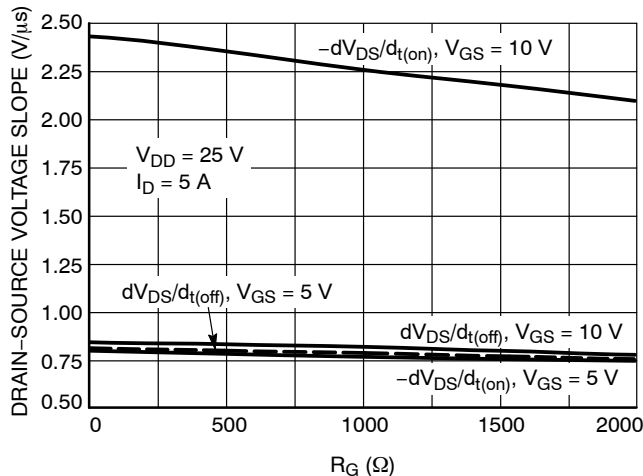

Figure 19. Drain-Source Voltage Slope during Turn On and Turn Off vs. Gate Resistance

# NCV8403, NCV8403A

## TYPICAL PERFORMANCE CURVES

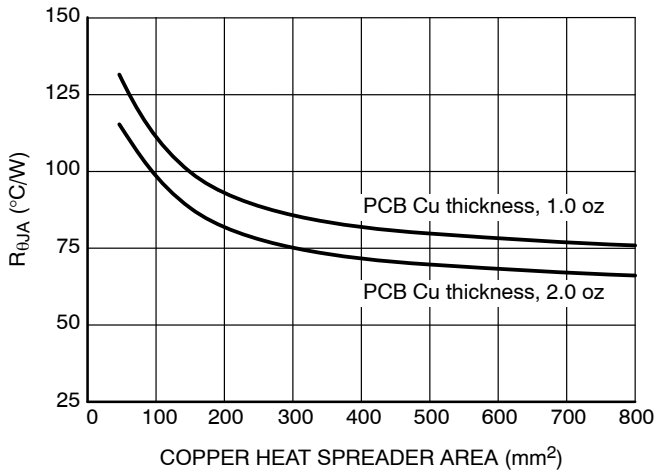

Figure 20.  $R_{\theta JA}$  vs. Copper Area – SOT-223

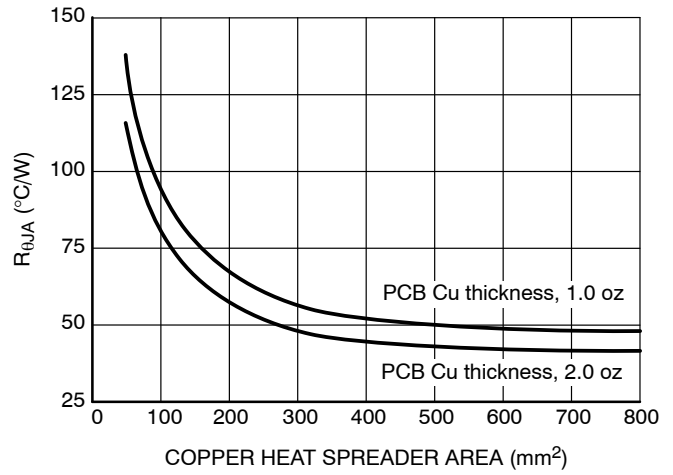

Figure 21.  $R_{\theta JA}$  vs. Copper Area – DPAK

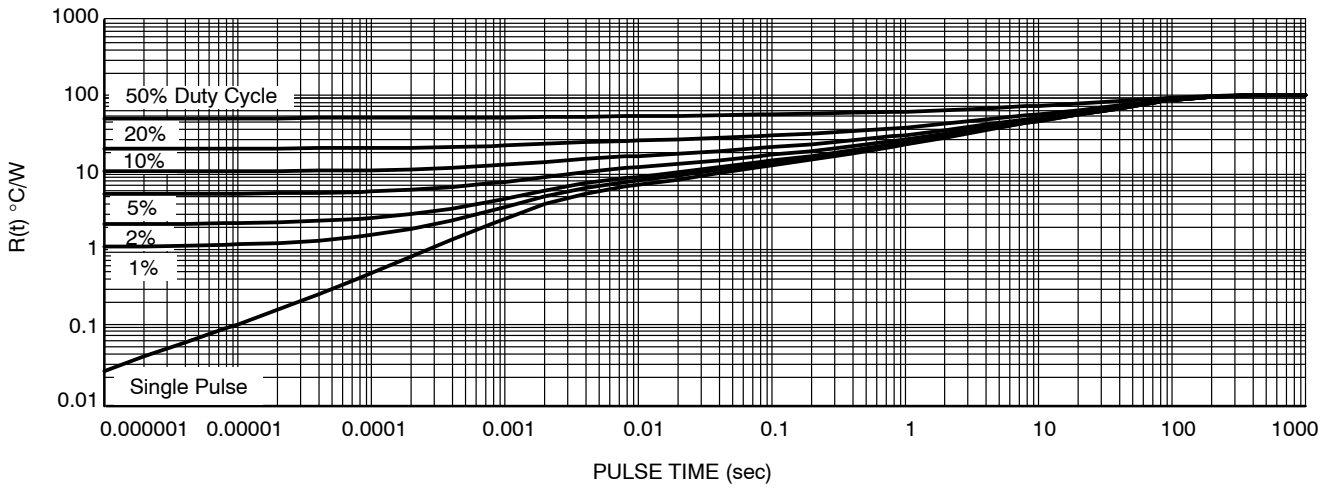

Figure 22. Transient Thermal Resistance – SOT-223 Version

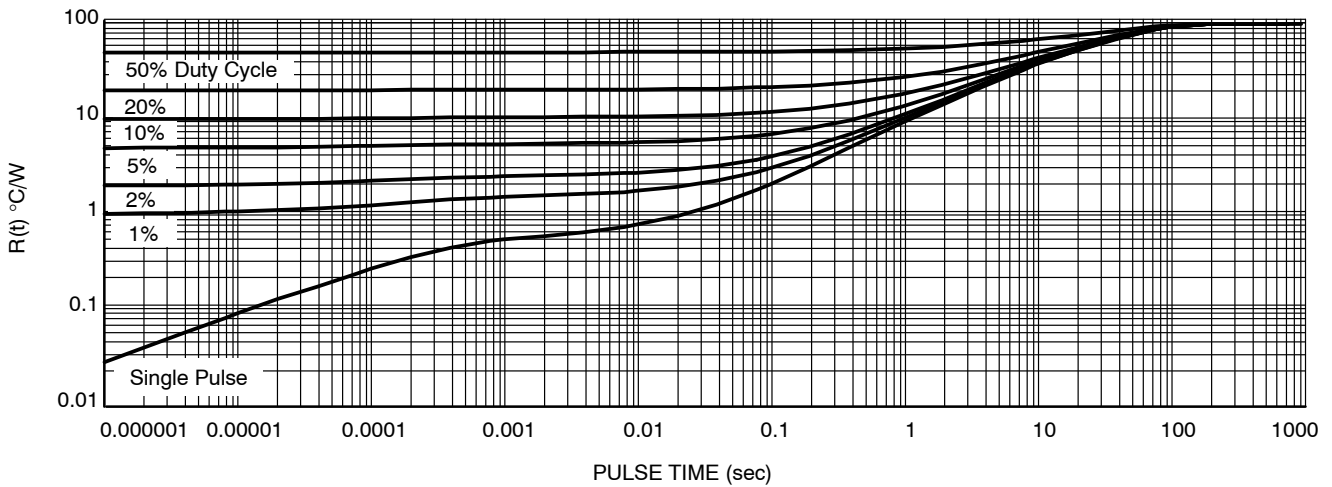

Figure 23. Transient Thermal Resistance – DPAK Version

# NCV8403, NCV8403A

## TEST CIRCUITS AND WAVEFORMS

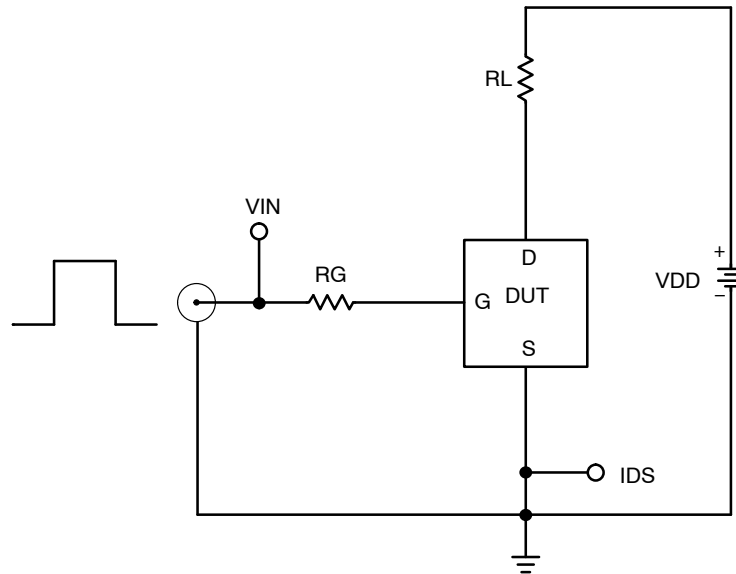

Figure 24. Resistive Load Switching Test Circuit

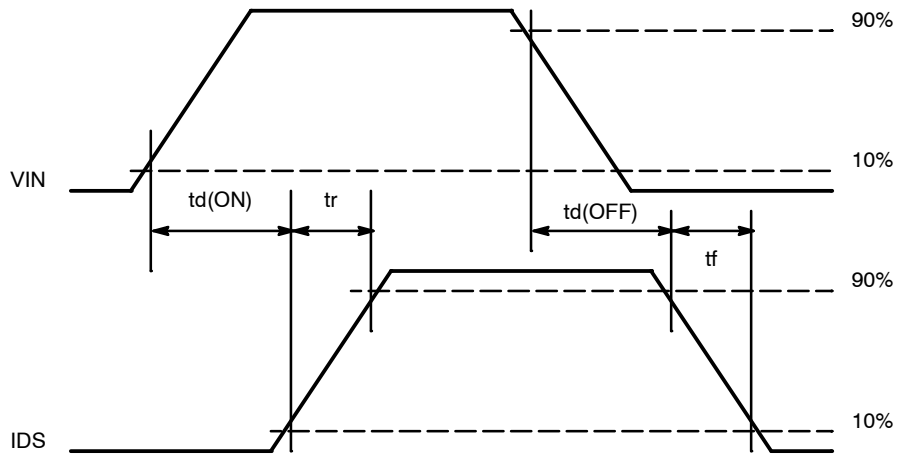

Figure 25. Resistive Load Switching Waveforms



# NCV8403, NCV8403A

## TEST CIRCUITS AND WAVEFORMS

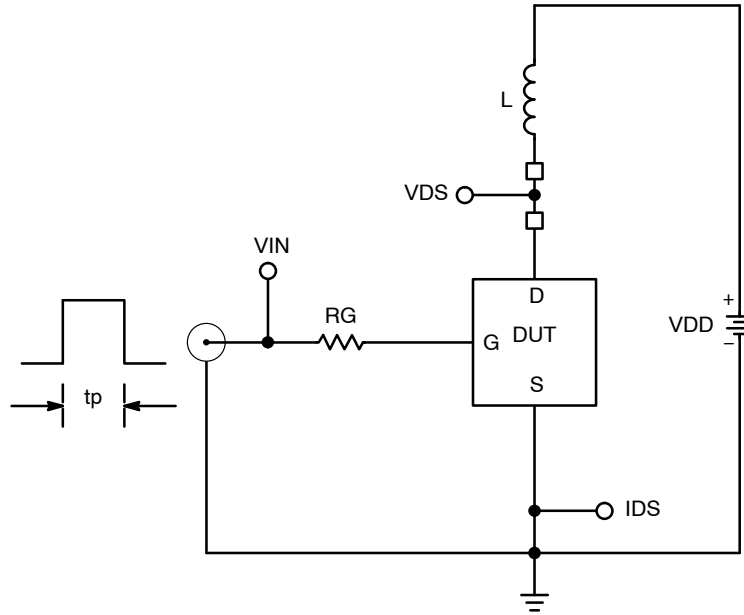

Figure 26. Inductive Load Switching Test Circuit

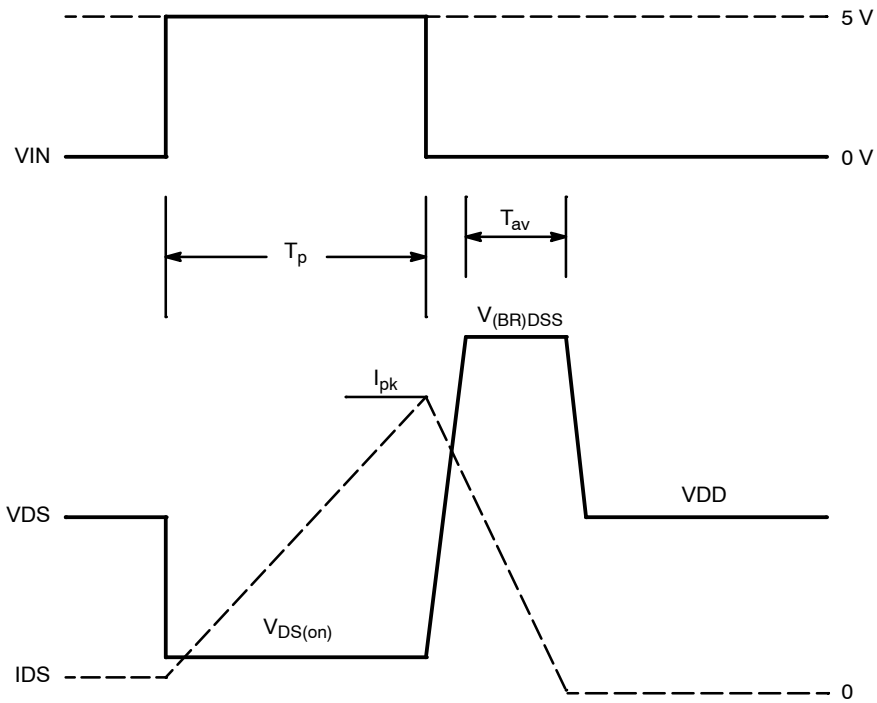

Figure 27. Inductive Load Switching Waveforms

## NCV8403, NCV8403A

### ORDERING INFORMATION

Device	Package	Shipping†
NCV8403STT1G	SOT-223 (Pb-Free)	1000 / Tape & Reel
NCV8403STT3G	SOT-223 (Pb-Free)	4000 / Tape & Reel
NCV8403DTRKG	DPAK (Pb-Free)	2500 / Tape & Reel
NCV8403ASTT1G	SOT-223 (Pb-Free)	1000 / Tape & Reel
NCV8403ASTT3G	SOT-223 (Pb-Free)	4000 / Tape & Reel
NCV8403ADTRKG	DPAK (Pb-Free)	2500 / Tape & Reel

†For information on tape and reel specifications, including part orientation and tape sizes, please refer to our Tape and Reel Packaging Specifications Brochure, BRD8011/D.

# NCV8403, NCV8403A

## PACKAGE DIMENSIONS

SOT-223 (TO-261)  
CASE 318E-04  
ISSUE N

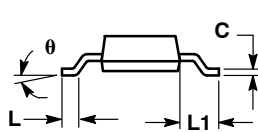
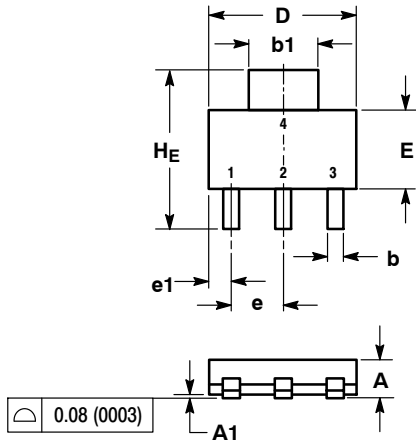

NOTES:  
1. DIMENSIONING AND TOLERANCING PER ASME Y14.5M, 1994.  
2. CONTROLLING DIMENSION: INCH.

DIM	MILLIMETERS			INCHES		
	MIN	NOM	MAX	MIN	NOM	MAX
A	1.50	1.63	1.75	0.060	0.064	0.068
A1	0.02	0.06	0.10	0.001	0.002	0.004
b	0.60	0.75	0.89	0.024	0.030	0.035
b1	2.90	3.06	3.20	0.115	0.121	0.126
c	0.24	0.29	0.35	0.009	0.012	0.014
D	6.30	6.50	6.70	0.249	0.256	0.263
E	3.30	3.50	3.70	0.130	0.138	0.145
e	2.20	2.30	2.40	0.087	0.091	0.094
e1	0.85	0.94	1.05	0.033	0.037	0.041
L	0.20	---	---	0.008	---	---
L1	1.50	1.75	2.00	0.060	0.069	0.078
HE	6.70	7.00	7.30	0.264	0.276	0.287
$\theta$	0°	-	10°	0°	-	10°

STYLE 3:  
PIN 1. GATE  
2. DRAIN  
3. SOURCE  
4. DRAIN

### SOLDERING FOOTPRINT

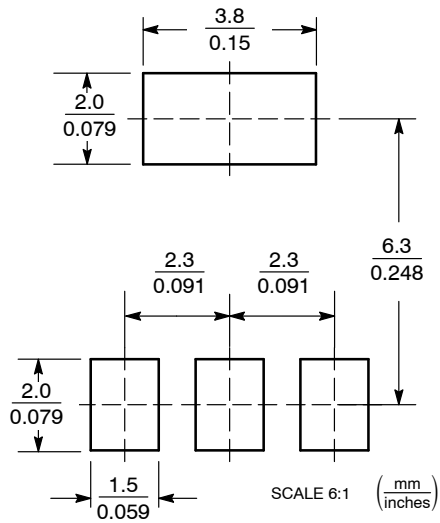

# NCV8403, NCV8403A

## PACKAGE DIMENSIONS

### DPAK (SINGLE GAUGE)

CASE 369C

ISSUE D

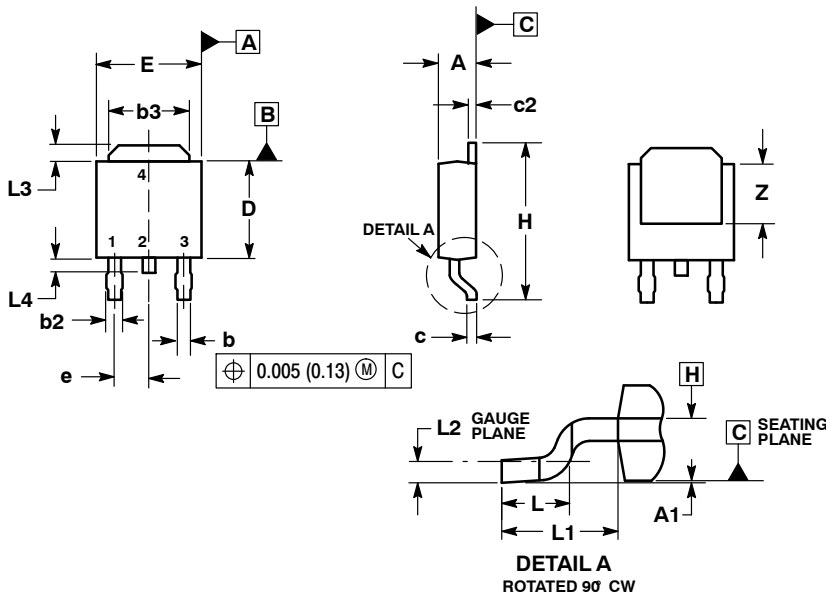

**NOTES:**

1. DIMENSIONING AND TOLERANCING PER ASME Y14.5M, 1994.
2. CONTROLLING DIMENSION: INCHES.
3. THERMAL PAD CONTOUR OPTIONAL WITHIN DIMENSIONS b3, L3 and Z.
4. DIMENSIONS D AND E DO NOT INCLUDE MOLD FLASH, PROTRUSIONS, OR BURRS. MOLD FLASH, PROTRUSIONS, OR GATE BURRS SHALL NOT EXCEED 0.006 INCHES PER SIDE.
5. DIMENSIONS D AND E ARE DETERMINED AT THE OUTERMOST EXTREMES OF THE PLASTIC BODY.
6. DATUMS A AND B ARE DETERMINED AT DATUM PLANE H.

DIM	INCHES		MILLIMETERS	
	MIN	MAX	MIN	MAX
A	0.086	0.094	2.18	2.38
A1	0.000	0.005	0.00	0.13
b	0.025	0.035	0.63	0.89
b2	0.030	0.045	0.76	1.14
b3	0.180	0.215	4.57	5.46
c	0.018	0.024	0.46	0.61
c2	0.018	0.024	0.46	0.61
D	0.235	0.245	5.97	6.22
E	0.250	0.265	6.35	6.73
e	0.090 BSC		2.29 BSC	
H	0.370	0.410	9.40	10.41
L	0.055	0.070	1.40	1.78
L1	0.108 REF		2.74 REF	
L2	0.020 BSC		0.51 BSC	
L3	0.035	0.050	0.89	1.27
L4	---	0.040	---	1.01
Z	0.155	---	3.93	---

### SOLDERING FOOTPRINT\*

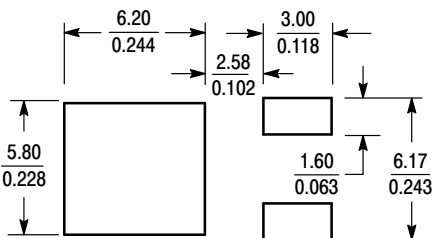

SCALE 3:1 (mm/inches)

\*For additional information on our Pb-Free strategy and soldering details, please download the ON Semiconductor Soldering and Mounting Techniques Reference Manual, SOLDERRM/D.

ON Semiconductor and are registered trademarks of Semiconductor Components Industries, LLC (SCILLC). SCILLC reserves the right to make changes without further notice to any products herein. SCILLC makes no warranty, representation or guarantee regarding the suitability of its products for any particular purpose, nor does SCILLC assume any liability arising out of the application or use of any product or circuit, and specifically disclaims any and all liability, including without limitation special, consequential or incidental damages. "Typical" parameters which may be provided in SCILLC data sheets and/or specifications can and do vary in different applications and actual performance may vary over time. All operating parameters, including "Typicals" must be validated for each customer application by customer's technical experts. SCILLC does not convey any license under its patent rights nor the rights of others. SCILLC products are not designed, intended, or authorized for use as components in systems intended for surgical implant into the body, or other applications intended to support or sustain life, or for any other application in which the failure of the SCILLC product could create a situation where personal injury or death may occur. Should Buyer purchase or use SCILLC products for any such unintended or unauthorized application, Buyer shall indemnify and hold SCILLC and its officers, employees, subsidiaries, affiliates, and distributors harmless against all claims, costs, damages, and expenses, and reasonable attorney fees arising out of, directly or indirectly, any claim of personal injury or death associated with such unintended or unauthorized use, even if such claim alleges that SCILLC was negligent regarding the design or manufacture of the part. SCILLC is an Equal Opportunity/Affirmative Action Employer. This literature is subject to all applicable copyright laws and is not for resale in any manner.

### PUBLICATION ORDERING INFORMATION

**LITERATURE FULFILLMENT:**  
Literature Distribution Center for ON Semiconductor  
P.O. Box 5163, Denver, Colorado 80217 USA  
**Phone:** 303-675-2175 or 800-344-3860 Toll Free USA/Canada  
**Fax:** 303-675-2176 or 800-344-3867 Toll Free USA/Canada  
**Email:** orderlit@onsemi.com

**N. American Technical Support:** 800-282-9855 Toll Free  
USA/Canada  
**Europe, Middle East and Africa Technical Support:**  
Phone: 421 33 790 2910  
**Japan Customer Focus Center**  
Phone: 81-3-5817-1050

**ON Semiconductor Website:** [www.onsemi.com](http://www.onsemi.com)  
**Order Literature:** <http://www.onsemi.com/orderlit>

For additional information, please contact your local Sales Representative



Компания «ЭлектроПласт» предлагает заключение долгосрочных отношений при поставках импортных электронных компонентов на взаимовыгодных условиях!

Наши преимущества:

- Оперативные поставки широкого спектра электронных компонентов отечественного и импортного производства напрямую от производителей и с крупнейших мировых складов;
- Поставка более 17-ти миллионов наименований электронных компонентов;
- Поставка сложных, дефицитных, либо снятых с производства позиций;
- Оперативные сроки поставки под заказ (от 5 рабочих дней);
- Экспресс доставка в любую точку России;
- Техническая поддержка проекта, помощь в подборе аналогов, поставка прототипов;
- Система менеджмента качества сертифицирована по Международному стандарту ISO 9001;
- Лицензия ФСБ на осуществление работ с использованием сведений, составляющих государственную тайну;
- Поставка специализированных компонентов (Xilinx, Altera, Analog Devices, Intersil, Interpoint, Microsemi, Aeroflex, Peregrine, Syfer, Eurofarad, Texas Instrument, Miteq, Cobham, E2V, MA-COM, Hittite, Mini-Circuits, General Dynamics и др.);

Помимо этого, одним из направлений компании «ЭлектроПласт» является направление «Источники питания». Мы предлагаем Вам помощь Конструкторского отдела:

- Подбор оптимального решения, техническое обоснование при выборе компонента;
- Подбор аналогов;
- Консультации по применению компонента;
- Поставка образцов и прототипов;
- Техническая поддержка проекта;
- Защита от снятия компонента с производства.



#### Как с нами связаться

**Телефон:** 8 (812) 309 58 32 (многоканальный)

**Факс:** 8 (812) 320-02-42

**Электронная почта:** [org@eplast1.ru](mailto:org@eplast1.ru)

**Адрес:** 198099, г. Санкт-Петербург, ул. Калинина, дом 2, корпус 4, литера А.