

EE-SX198/199/1018/1025/1041/1042/1070/1071

Miniature Transmissive
Photomicrosensor with 2- to 8-mm
Slot Width and Phototransistor
Output

- Stable sensing at temperatures as high as 95°C (EE-SX1041, EE-SX1070)
- Compact model with a 5-mm wide slot (EE-SX1041)
- Model with 12-mm deep and 5-mm wide slot (EE-SX1042)
- Miniature model with a 2-mm wide slot (EE-SX1018)
- Low-profile model (5.4 mm high) with a 2.8-mm slot width (EE-SX1025)

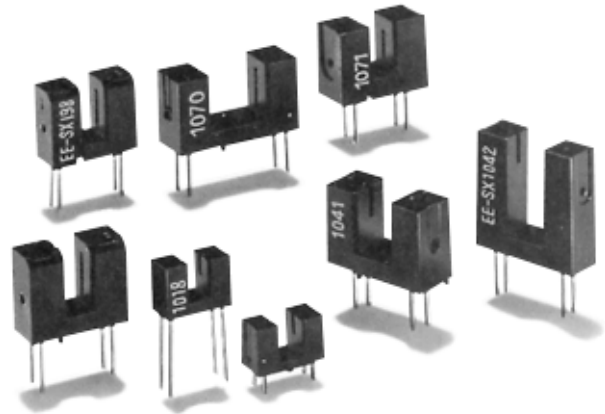

Ordering Information

Appearance	Sensing method	Slot width	Slot depth	Sensing object	Output configuration	Weight	Part number
	Transmissive	2 mm	4.5 mm	Opaque, 0.5 x 1.5 mm min.	Phototransistor	Approx. 0.2 g	EE-SX1018
		2.8 mm	4.4 mm				EE-SX1025
		3 mm	7.5 mm	Opaque, 0.5 x 2 mm min.		Approx. 0.6 g	EE-SX198
							EE-SX199
							EE-SX1071
		5 mm	8.2 mm	Opaque, 0.5 x 2.2 mm min.		Approx. 0.8 g	EE-SX1041
		5 mm	12 mm	Opaque, 0.5 x 2 mm min.			EE-SX1042
		8 mm	8.2 mm	Opaque, 0.5 x 2.2 mm min.		Approx. 0.6 g	EE-SX1070

Specifications

■ ABSOLUTE MAXIMUM RATINGS (T_A = 25°C (77°F))

Item	Symbol	Rated value
Emitter	Forward current	I _F 50 mA*
	Reverse voltage	V _R 4 V
Detector	Collector-emitter voltage	V _{CEO} 30 V
	Collector current	I _C 20 mA
	Collector dissipation	P _C 100 mW*
Ambient temperature	Operating	Topr -25°C to 85°C (-13°F to 185°F)**
	Storage	Tstg -30°C to 100°C (-22°F to 212°F)

*Refer to Engineering Data if the ambient temperature is not within the normal room temperature range.

**The operating temperature of the EE-SX1041/1070 is -25° to 95°C (-13°F to 203°F).

■ CHARACTERISTICS (T_A = 25°C (77°F))

Item	Symbol	EE-SX1018/1025/1041/1042/1070/1071		EE-SX198/199	
		Value	Condition	Value	Condition
Emitter	Forward voltage	V _F 1.2 V typ. 1.5 V max.	I _F = 30 mA	1.2 V typ. 1.4 V max.	I _F = 20 mA
	Reverse current	I _R 0.01 μA typ. 10 μA max.	V _R = 4 V	0.01 μA typ. 10 μA max.	V _R = 4 V
	Peak emission wavelength	λ _{p(L)} 940 nm typ.	I _F = 20 mA	940 nm typ.	I _F = 20 mA
Detector	Dark current	I _D 2 nA typ. 200 nA max.	V _{CE} = 10 V 0/x	2 nA typ. 200 nA max.	V _{CE} = 10 V 0/x
	Peak spectral sensitivity wavelength	λ _{p(P)} 850 nm typ.	V _{CE} = 10 V	850 nm typ.	V _{CE} = 10 V
Combination	Light current (collector current)	I _L 0.5 mA min. 14 mA max.	I _F = 20 mA V _{CE} = 10 V	0.5 mA min. 14 mA max.	I _F = 20 mA V _{CE} = 5 V
	Collector-emitter saturated voltage	V _{CE (sat)} 0.1 V typ. 0.4 V max.	I _F = 20 mA I _L = 0.1 mA	0.1 V typ. 0.4 V max.	I _F = 40 mA I _L = 0.5 mA
	Rising time (See Note.)	t _r 4 μs typ.	V _{CC} = 5 V R _L = 100 Ω I _L = 5 mA	4 μs typ.	V _{CC} = 5 V R _L = 100 Ω
	Falling time (See Note.)	t _f 4 μs typ.		4 μs typ.	I _L = 5 mA

Note: The following illustrations show the rising time, t_r, and the falling time, t_f.



Engineering Data

Note: The operating conditions of the photomicrosensor must be within the absolute maximum rating ranges.

TEMPERATURE CHARACTERISTICS

EE-SX198/199/1018/1025/1042/1071

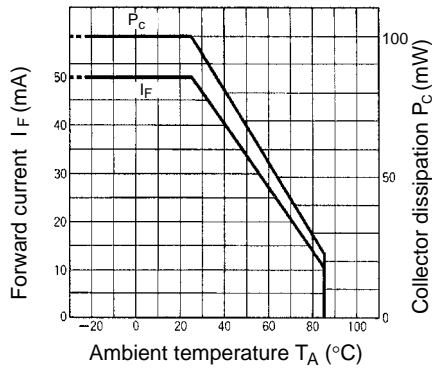

EE-SX1070/1041

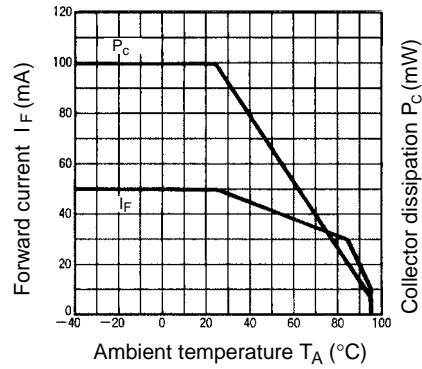

INPUT CHARACTERISTICS (TYPICAL)



DARK CURRENT TEMPERATURE DEPENDENCY (TYPICAL)



SWITCHING CHARACTERISTICS (TYPICAL)

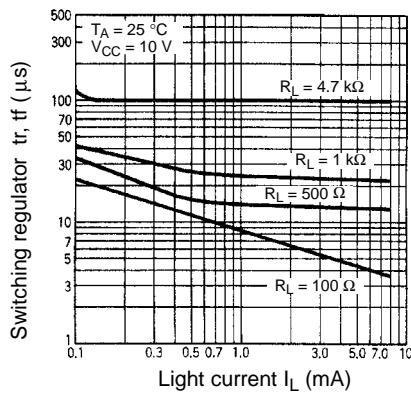

I/O CHARACTERISTIC (TYPICAL)

EE-SX1018/1025



EE-SX198/199

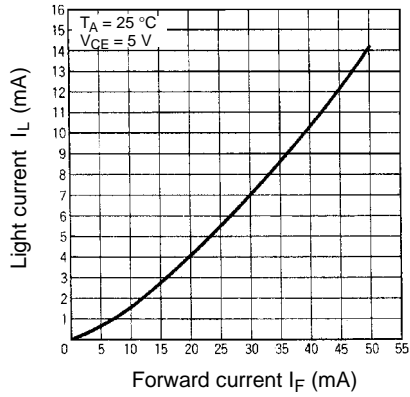

EE-SX1041/1042/1070/1071

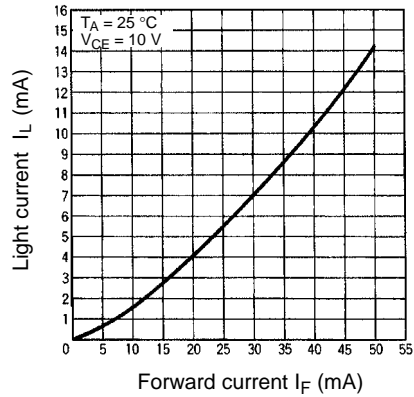

OUTPUT CHARACTERISTICS (TYPICAL)

EE-SX198/199/1041/1042/1070/1071

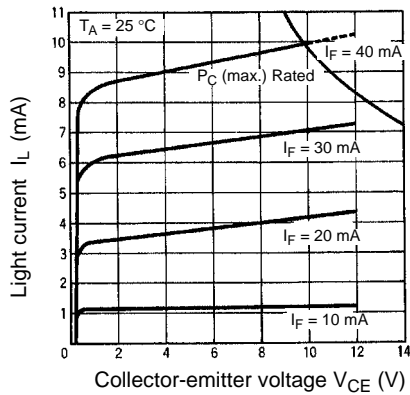

EE-SX1018/1025

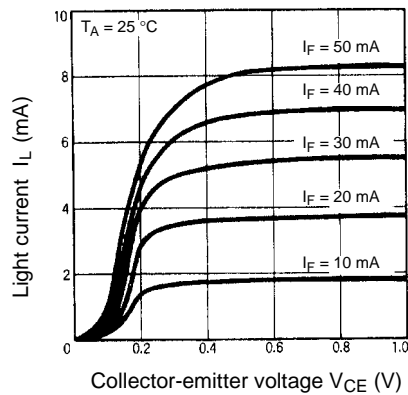

LIGHT CURRENT TEMPERATURE DEPENDENCY (TYPICAL)

EE-SX198/199

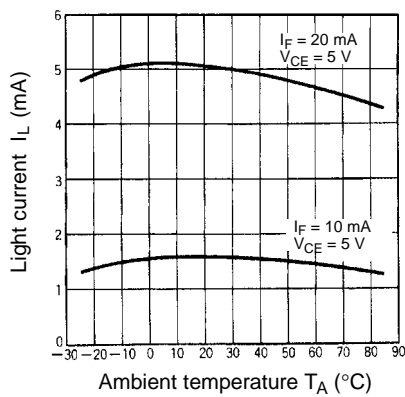

EE-SX1018/1025

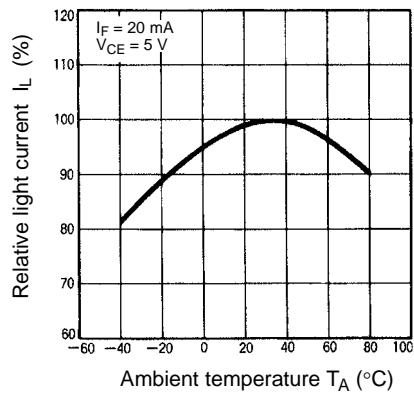

EE-SX1041/1042/1070/1071



■ **SENSING POSITION CHARACTERISTICS (TYPICAL)**

EE-SX198/199



EE-SX1018



EE-SX1025



EE-SX1041



EE-SX1042



EE-SX1070/1071



Dimensions

Unit: mm (inch)

EE-SX198

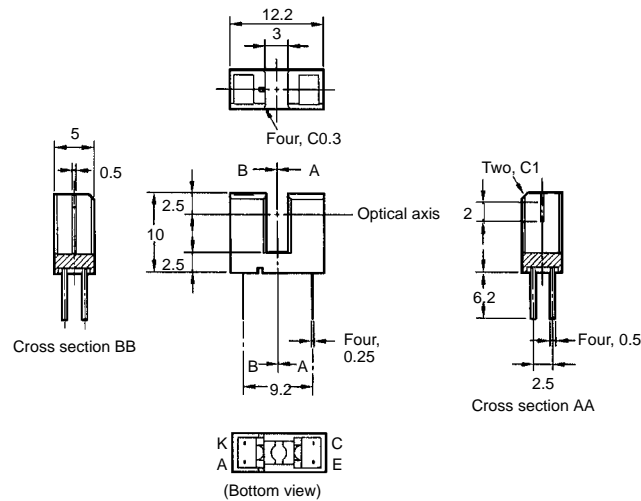

EE-SX199

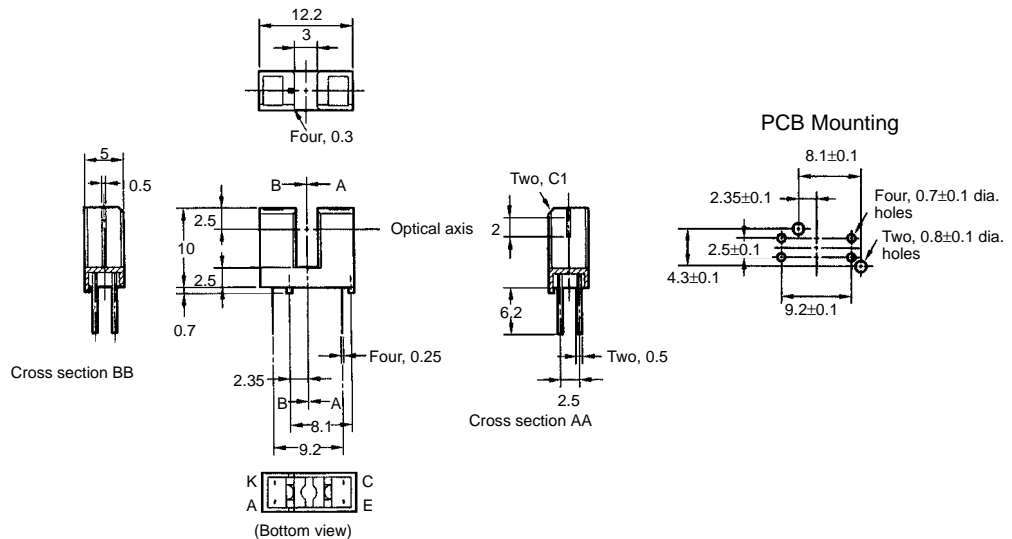
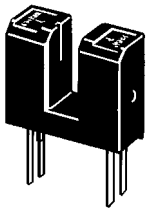

EE-SX1018



■ EE-SX1025

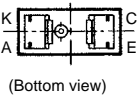

■ EE-SX1041

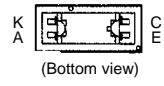
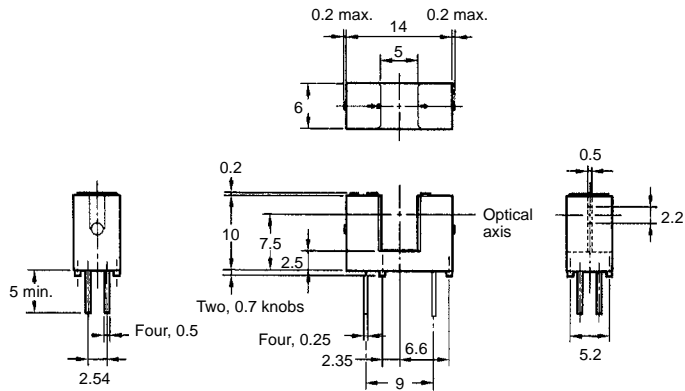

■ EE-SX1042

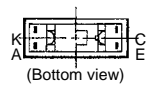
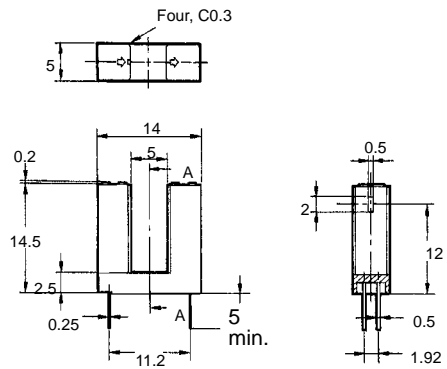
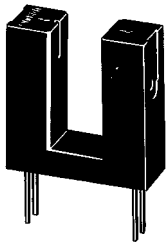

Cross section AA

■ EE-SX1070

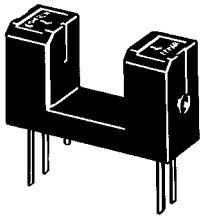

■ EE-SX1071

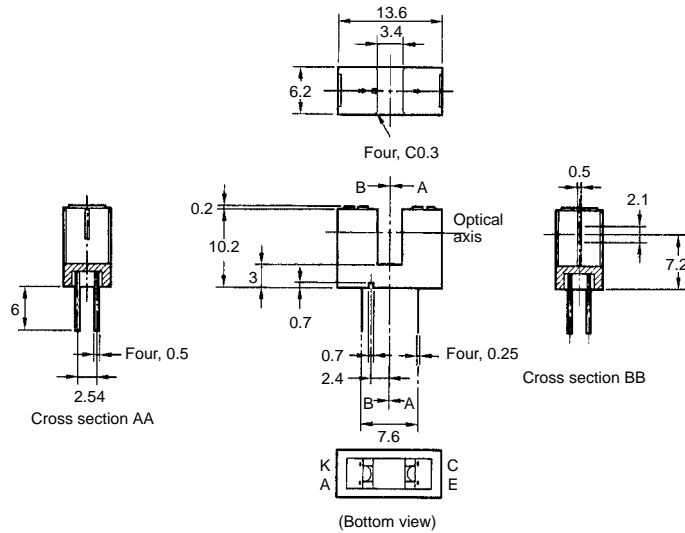

Precautions

Refer to the Technical Information Section for general precautions.

NOTE: DIMENSIONS SHOWN ARE IN MILLIMETERS. To convert millimeters to inches divide by 25.4.

OMRON[®]
OMRON ELECTRONICS, INC.
 One East Commerce Drive
 Schaumburg, IL 60173
1-800-55-OMRON

OMRON CANADA, INC.
 885 Milner Avenue
 Scarborough, Ontario M1B 5V8
416-286-6465



Компания «ЭлектроПласт» предлагает заключение долгосрочных отношений при поставках импортных электронных компонентов на взаимовыгодных условиях!

Наши преимущества:

- Оперативные поставки широкого спектра электронных компонентов отечественного и импортного производства напрямую от производителей и с крупнейших мировых складов;
- Поставка более 17-ти миллионов наименований электронных компонентов;
- Поставка сложных, дефицитных, либо снятых с производства позиций;
- Оперативные сроки поставки под заказ (от 5 рабочих дней);
- Экспресс доставка в любую точку России;
- Техническая поддержка проекта, помощь в подборе аналогов, поставка прототипов;
- Система менеджмента качества сертифицирована по Международному стандарту ISO 9001;
- Лицензия ФСБ на осуществление работ с использованием сведений, составляющих государственную тайну;
- Поставка специализированных компонентов (Xilinx, Altera, Analog Devices, Intersil, Interpoint, Microsemi, Aeroflex, Peregrine, Syfer, Eurofarad, Texas Instrument, Miteq, Cobham, E2V, MA-COM, Hittite, Mini-Circuits, General Dynamics и др.);

Помимо этого, одним из направлений компании «ЭлектроПласт» является направление «Источники питания». Мы предлагаем Вам помощь Конструкторского отдела:

- Подбор оптимального решения, техническое обоснование при выборе компонента;
- Подбор аналогов;
- Консультации по применению компонента;
- Поставка образцов и прототипов;
- Техническая поддержка проекта;
- Защита от снятия компонента с производства.



Как с нами связаться

Телефон: 8 (812) 309 58 32 (многоканальный)

Факс: 8 (812) 320-02-42

Электронная почта: org@eplast1.ru

Адрес: 198099, г. Санкт-Петербург, ул. Калинина, дом 2, корпус 4, литера А.