

Power management (dual transistors)

EMF32 / UMF32N

DTA143T and 2SK3019 are housed independently in a EMT6 package.

●Application

Power management circuit

●Features

- 1) Power switching circuit in a single package.
- 2) Mounting cost and area can be cut in half.

●Structure

Silicon epitaxial planar transistor

●Inner circuits

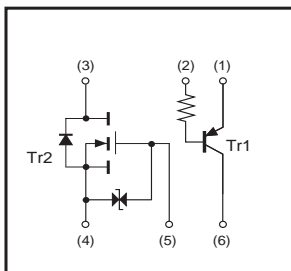

●Dimensions (Unit : mm)

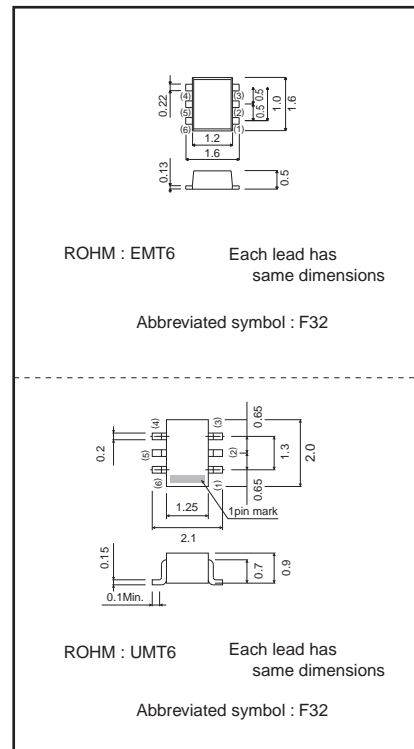

●Packaging specifications

Type	EMF32	UMF32N
Package	EMT6	UMT6
Marking	F32	F32
Code	T2R	TR
Basic ordering unit (pieces)	8000	3000

●Absolute maximum ratings (Ta=25°C)

Tr1

Parameter	Symbol	Limits	Unit
Collector-base voltage	V _{CB0}	-50	V
Collector-emitter voltage	V _{CE0}	-50	V
Emitter-base voltage	V _{EB0}	-5	V
Collector current	I _c	-100	mA
Power dissipation	P _c	150(TOTAL)	mW *1
Junction temperature	T _j	150	°C
Range of storage temperature	T _{stg}	-55 to +150	°C

*1 120mW per element must not be exceeded. Each terminal mounted on a recommended land.

Tr2

Parameter	Symbol	Limits	Unit
Drain-source voltage	V _{DSS}	30	V
Gate-source voltage	V _{GSS}	±20	V
Drain current	Continuous	I _D	100 mA
	Pulsed	I _{DP}	200 mA *1
Reverse drain current	Continuous	I _{DR}	100 mA
	Pulsed	I _{DRP}	200 mA *1
Total power dissipation	P _D	150(TOTAL)	mW *2
Channel temperature	T _{ch}	150	°C
Range of storage temperature	T _{stg}	-55 to +150	°C

*1 PW≤10ms Duty cycle≤50%

*2 120mW per element must not be exceeded. Each terminal mounted on a recommended land.

●Electrical characteristics (Ta=25°C)

Tr1

Parameter	Symbol	Min.	Typ.	Max.	Unit	Conditions
Collector-base breakdown voltage	BV _{CB0}	-50	-	-	V	I _c =-50μA
Collector-emitter breakdown voltage	BV _{CE0}	-50	-	-	V	I _c =-1mA
Emitter-base breakdown voltage	BV _{EB0}	-5	-	-	V	I _E =-50μA
Collector cutoff current	I _{CB0}	-	-	-0.5	μA	V _{CB} =-50V
Emitter cutoff current	I _{EB0}	-	-	-0.5	μA	V _{EB} =-4V
Collector-emitter saturation voltage	V _{CE(sat)}	-	-	-0.3	V	I _c /I _B =-5mA/-0.25mA
DC current transfer ratio	h _{FE}	100	250	600	-	I _c =-1mA, V _{CE} =-5V
Input resistance	R _i	3.29	4.7	6.11	kΩ	-
Transition frequency	f _T	-	250	-	MHz	V _{CE} =-10V, I _E =5mA, f=100MHz *

* Transition frequency of the device

Tr2

Parameter	Symbol	Min.	Typ.	Max.	Unit	Conditions
Gate-source leakage	I _{GSS}	-	-	±1	μA	V _{GS} =±20V, V _{DS} =0V
Drain-source breakdown voltage	V _{(BR)DSS}	30	-	-	V	I _D =10μA, V _{GS} =0V
Zero gate voltage drain current	I _{DSS}	-	-	1.0	μA	V _{DS} =30V, V _{GS} =0V
Gate-threshold voltage	V _{GS(th)}	0.8	-	1.5	V	V _{DS} =3V, I _D =100μA
Static drain-source on-state resistance	R _{DS(on)}	-	5	8	Ω	I _D =10mA, V _{GS} =4V
		-	7	13	Ω	I _D =1mA, V _{GS} =2.5V
Forward transfer admittance	Y _{fs}	20	-	-	ms	V _{DS} =3V, I _D =10mA
Input capacitance	C _{iss}	-	13	-	pF	V _{DS} =5V, V _{GS} =0V, f=1MHz
Output capacitance	C _{oss}	-	9	-	pF	
Reverse transfer capacitance	C _{rss}	-	4	-	pF	
Turn-on delay time	t _{d(on)}	-	15	-	ns	I _D =10mA, V _{DD} =5V, V _{GS} =5V, R _L =500Ω, R _{GS} =10Ω
Rise time	t _r	-	35	-	ns	
Turn-off delay time	t _{d(off)}	-	80	-	ns	
Fall time	t _f	-	80	-	ns	

●Electrical characteristic curves

Tr1

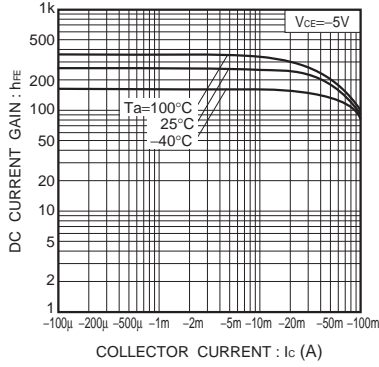

Fig.1 DC current gain vs. collector current

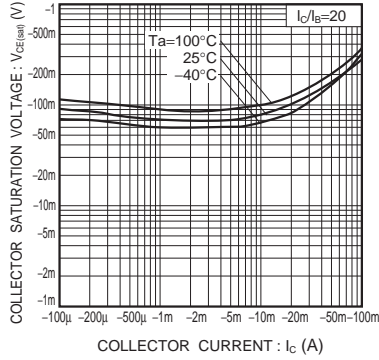

Fig.2 Collector-emitter saturation voltage vs. collector current

Tr2

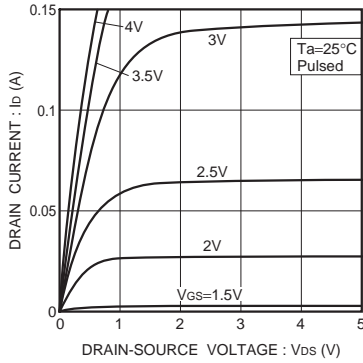

Fig.3 Typical output characteristics

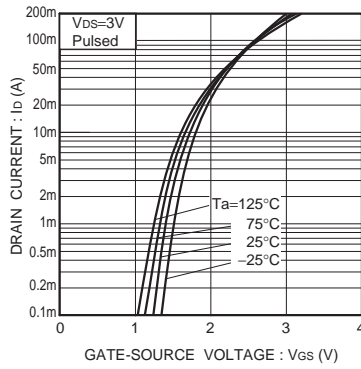

Fig.4 Typical transfer characteristics

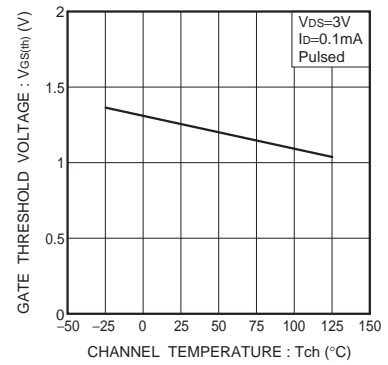

Fig.5 Gate threshold voltage vs. channel temperature

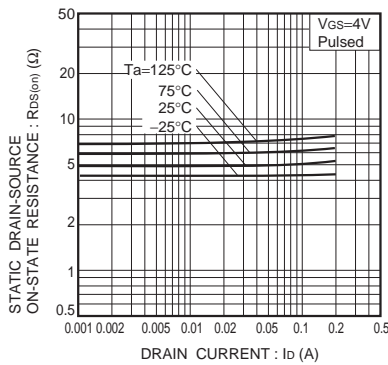

Fig.6 Static drain-source on-state resistance vs. drain current (I)

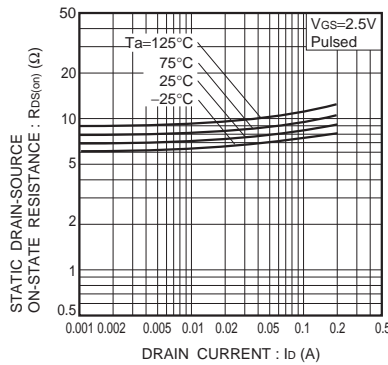

Fig.7 Static drain-source on-state resistance vs. drain current (II)

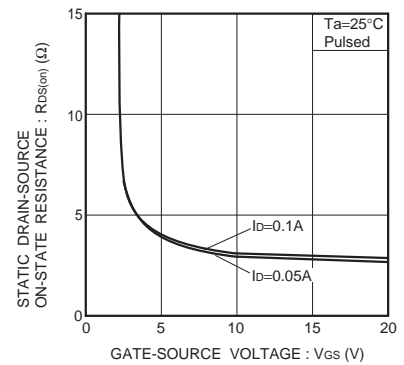

Fig.8 Static drain-source on-state resistance vs. gate-source voltage

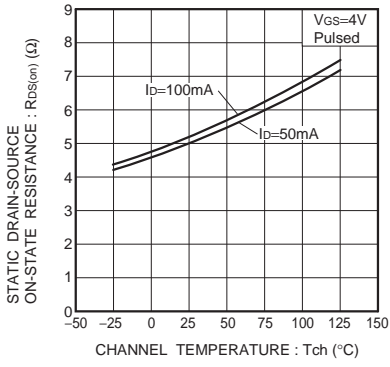

Fig.9 Static drain-source on-state resistance vs. channel temperature

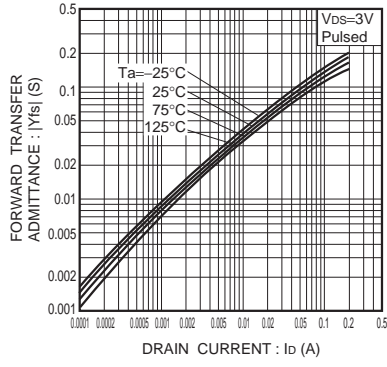

Fig.10 Forward transfer admittance vs. drain current

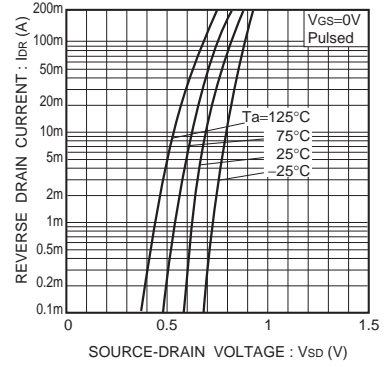

Fig.11 Reverse drain current vs. source-drain voltage (I)

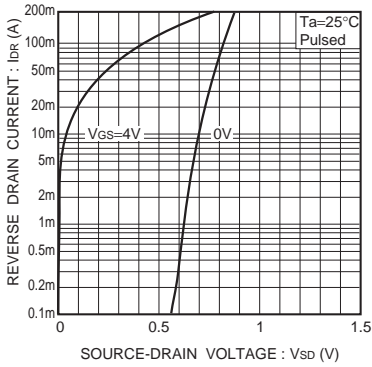

Fig.12 Reverse drain current vs. source-drain voltage (II)

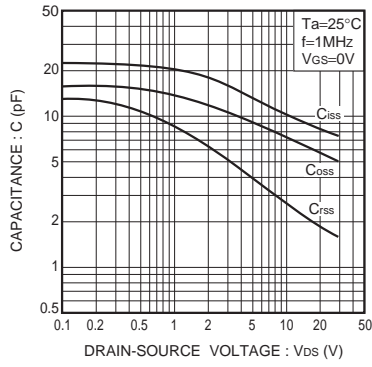

Fig.13 Typical capacitance vs. drain-source voltage

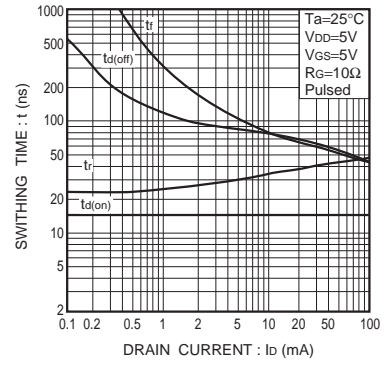

Fig.14 Switching characteristics

Notes

No copying or reproduction of this document, in part or in whole, is permitted without the consent of ROHM Co.,Ltd.

The content specified herein is subject to change for improvement without notice.

The content specified herein is for the purpose of introducing ROHM's products (hereinafter "Products"). If you wish to use any such Product, please be sure to refer to the specifications, which can be obtained from ROHM upon request.

Examples of application circuits, circuit constants and any other information contained herein illustrate the standard usage and operations of the Products. The peripheral conditions must be taken into account when designing circuits for mass production.

Great care was taken in ensuring the accuracy of the information specified in this document. However, should you incur any damage arising from any inaccuracy or misprint of such information, ROHM shall bear no responsibility for such damage.

The technical information specified herein is intended only to show the typical functions of and examples of application circuits for the Products. ROHM does not grant you, explicitly or implicitly, any license to use or exercise intellectual property or other rights held by ROHM and other parties. ROHM shall bear no responsibility whatsoever for any dispute arising from the use of such technical information.

The Products specified in this document are intended to be used with general-use electronic equipment or devices (such as audio visual equipment, office-automation equipment, communication devices, electronic appliances and amusement devices).

The Products specified in this document are not designed to be radiation tolerant.

While ROHM always makes efforts to enhance the quality and reliability of its Products, a Product may fail or malfunction for a variety of reasons.

Please be sure to implement in your equipment using the Products safety measures to guard against the possibility of physical injury, fire or any other damage caused in the event of the failure of any Product, such as derating, redundancy, fire control and fail-safe designs. ROHM shall bear no responsibility whatsoever for your use of any Product outside of the prescribed scope or not in accordance with the instruction manual.

The Products are not designed or manufactured to be used with any equipment, device or system which requires an extremely high level of reliability the failure or malfunction of which may result in a direct threat to human life or create a risk of human injury (such as a medical instrument, transportation equipment, aerospace machinery, nuclear-reactor controller, fuel-controller or other safety device). ROHM shall bear no responsibility in any way for use of any of the Products for the above special purposes. If a Product is intended to be used for any such special purpose, please contact a ROHM sales representative before purchasing.

If you intend to export or ship overseas any Product or technology specified herein that may be controlled under the Foreign Exchange and the Foreign Trade Law, you will be required to obtain a license or permit under the Law.



Thank you for your accessing to ROHM product informations.
More detail product informations and catalogs are available, please contact us.

ROHM Customer Support System

<http://www.rohm.com/contact/>



Компания «ЭлектроПласт» предлагает заключение долгосрочных отношений при поставках импортных электронных компонентов на взаимовыгодных условиях!

Наши преимущества:

- Оперативные поставки широкого спектра электронных компонентов отечественного и импортного производства напрямую от производителей и с крупнейших мировых складов;
- Поставка более 17-ти миллионов наименований электронных компонентов;
- Поставка сложных, дефицитных, либо снятых с производства позиций;
- Оперативные сроки поставки под заказ (от 5 рабочих дней);
- Экспресс доставка в любую точку России;
- Техническая поддержка проекта, помощь в подборе аналогов, поставка прототипов;
- Система менеджмента качества сертифицирована по Международному стандарту ISO 9001;
- Лицензия ФСБ на осуществление работ с использованием сведений, составляющих государственную тайну;
- Поставка специализированных компонентов (Xilinx, Altera, Analog Devices, Intersil, Interpoint, Microsemi, Aeroflex, Peregrine, Syfer, Eurofarad, Texas Instrument, Miteq, Cobham, E2V, MA-COM, Hittite, Mini-Circuits, General Dynamics и др.);

Помимо этого, одним из направлений компании «ЭлектроПласт» является направление «Источники питания». Мы предлагаем Вам помощь Конструкторского отдела:

- Подбор оптимального решения, техническое обоснование при выборе компонента;
- Подбор аналогов;
- Консультации по применению компонента;
- Поставка образцов и прототипов;
- Техническая поддержка проекта;
- Защита от снятия компонента с производства.



Как с нами связаться

Телефон: 8 (812) 309 58 32 (многоканальный)

Факс: 8 (812) 320-02-42

Электронная почта: org@eplast1.ru

Адрес: 198099, г. Санкт-Петербург, ул. Калинина, дом 2, корпус 4, литера А.