

Part Number: WP934SA/LILYLGD

High Efficiency Red
Yellow
Green

Features

- Pre-trimmed leads for pc mounting.
- Black case enhances contrast ratio.
- Wide viewing angle.
- High reliability life measured in years.
- Housing UL rating:94V-0.
- Housing material: type 66 nylon.
- Low current IF=2mA operating.
- RoHS compliant.

Descriptions

- The High Efficiency Red source color devices are made with Gallium Arsenide Phosphide on Gallium Phosphide Orange Light Emitting Diode.
- The Yellow source color devices are made with Gallium Arsenide Phosphide on Gallium Phosphide Yellow Light Emitting Diode.
- The Green source color devices are made with Gallium Phosphide Green Light Emitting Diode.

Package Dimensions

LED1:RED
LED2:YELLOW
LED3:GREEN

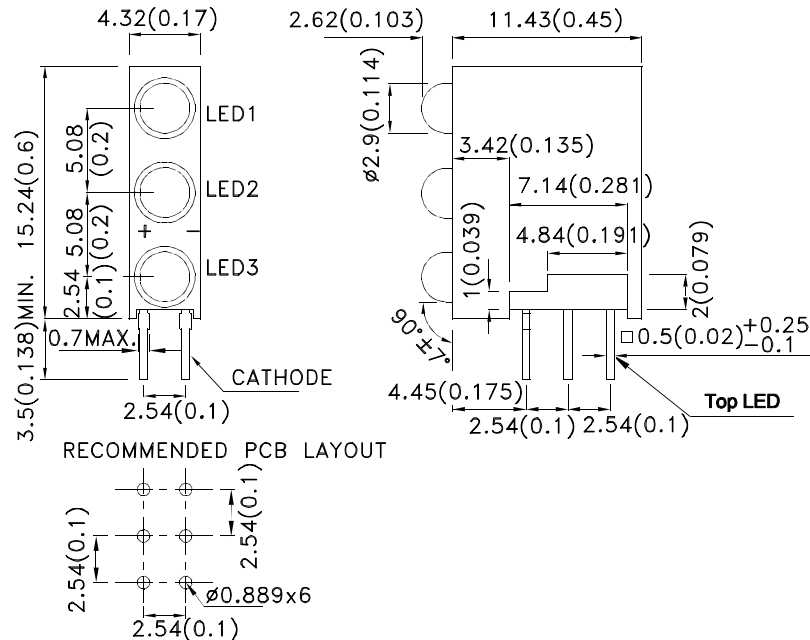

Notes:

1. All dimensions are in millimeters (inches).
2. Tolerance is $\pm 0.25(0.01)$ unless otherwise noted.
3. Lead spacing is measured where the leads emerge from the package.
4. The specifications, characteristics and technical data described in the datasheet are subject to change without prior notice.



Selection Guide

| Part No. | Emitting Color (Material) | Lens Type | Iv (mcd) [2] @ 2mA | | Viewing Angle [1] |
|-----------------|---------------------------------|-----------------|-----------------------|------|----------------------|
| | | | Min. | Typ. | 2θ1/2 |
| WP934SA/LILYLGD | High Efficiency Red (GaAsP/GaP) | Red Diffused | 0.35 | 1 | 40° |
| | | | *0.2 | *0.6 | |
| | Yellow (GaAsP/GaP) | Yellow Diffused | 0.7 | 1.5 | 40° |
| | | | *0.7 | *1.5 | |
| | Green (GaP) | Green Diffused | 1 | 2 | 40° |
| | | | *1 | *2 | |

Notes:

1. θ1/2 is the angle from optical centerline where the luminous intensity is 1/2 of the optical peak value.

2. Luminous intensity/ luminous Flux: +/-15%.

* Luminous intensity value is traceable to CIE127-2007 standards.

Electrical / Optical Characteristics at TA=25°C

| Symbol | Parameter | Emitting Color | Typ. | Max. | Units | Test Conditions |
|--------------------|--------------------------|----------------------------------------|--------------------|-------------------|-------|---------------------------|
| λ _{peak} | Peak Wavelength | High Efficiency Red Yellow Green | 627 590 565 | | nm | I _F =2mA |
| λD [1] | Dominant Wavelength | High Efficiency Red Yellow Green | 617 588 568 | | nm | I _F =2mA |
| Δλ1/2 | Spectral Line Half-width | High Efficiency Red Yellow Green | 45 35 30 | | nm | I _F =2mA |
| C | Capacitance | High Efficiency Red Yellow Green | 15 20 15 | | pF | V _F =0V;f=1MHz |
| V _F [2] | Forward Voltage | High Efficiency Red Yellow Green | 1.7 1.85 1.9 | 2.5 2.5 2.5 | V | I _F =2mA |
| I _R | Reverse Current | High Efficiency Red Yellow Green | | 10 10 10 | uA | V _R =5V |

Notes:

1.Wavelength: +/-1nm.

2.Forward Voltage: +/-0.1V.

3.Wavelength value is traceable to CIE127-2007 standards.

4.Excess driving current and/or operating temperature higher than recommended conditions may result in severe light degradation or premature failure.

Absolute Maximum Ratings at TA=25°C

| Parameter | High Efficiency Red | Yellow | Green | Units |
|-------------------------------|---------------------|--------|-------|-------|
| Power dissipation | 75 | 75 | 62.5 | mW |
| DC Forward Current | 30 | 30 | 25 | mA |
| Peak Forward Current [1] | 160 | 140 | 140 | mA |
| Reverse Voltage | 5 | | | V |
| Operating/Storage Temperature | -40°C To +85°C | | | |
| Lead Solder Temperature [2] | 260°C For 3 Seconds | | | |
| Lead Solder Temperature [3] | 260°C For 5 Seconds | | | |

Notes:

1. 1/10 Duty Cycle, 0.1ms Pulse Width.

2. 2mm below package base.

3. 5mm below package base.

4. Relative humidity levels maintained between 40% and 60% in production area are recommended to avoid the build-up of static electricity – Ref JEDEC/JESD625-A and JEDEC/J-STD-033.

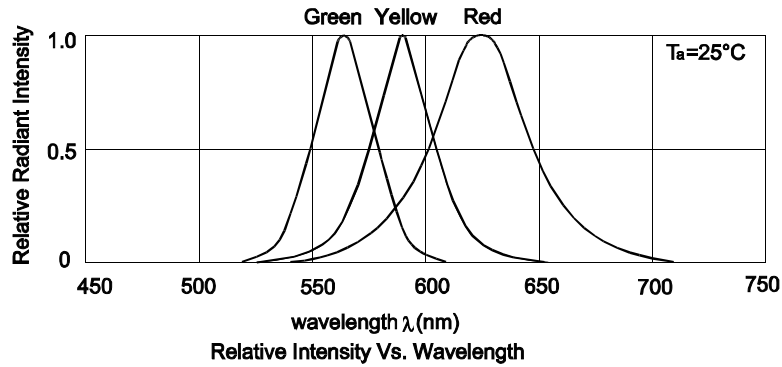

WP934SA/LILYLGD High Efficiency Red

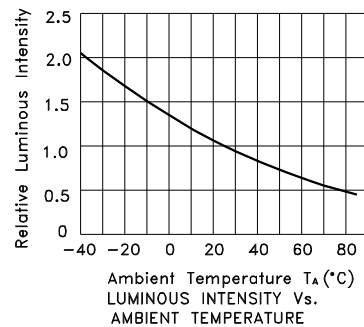
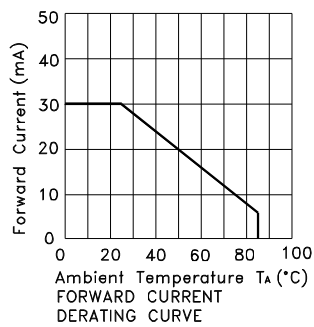
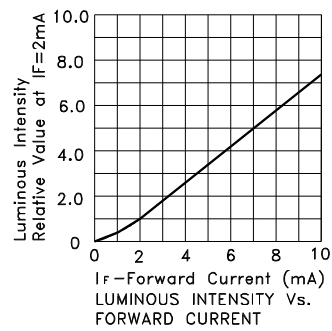
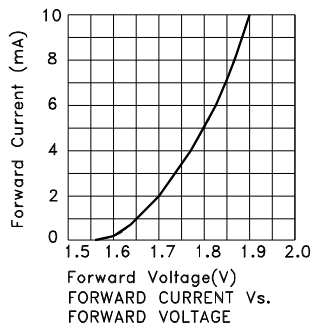

Yellow

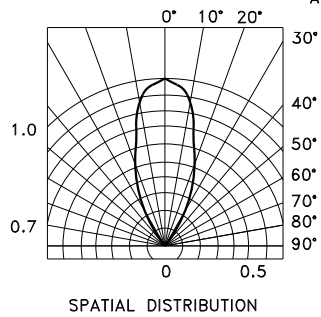
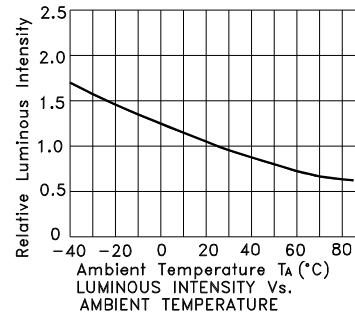
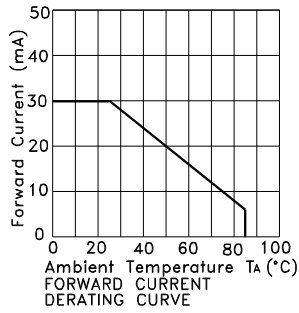
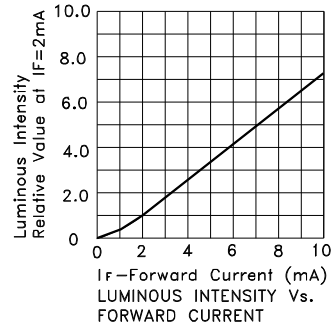
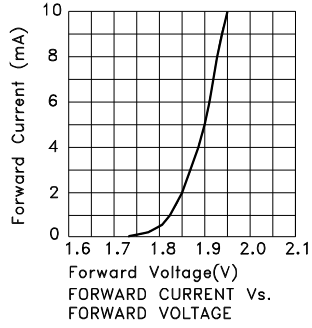

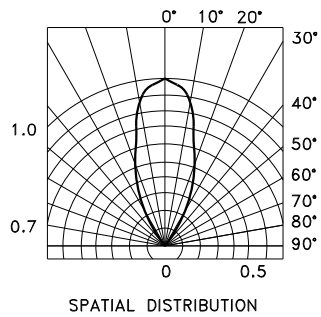
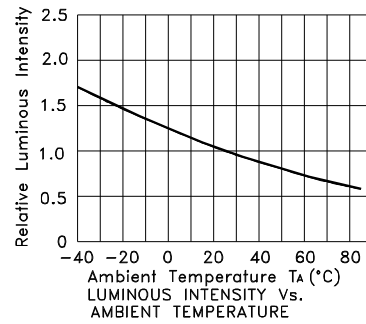
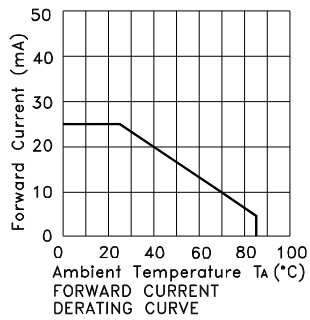
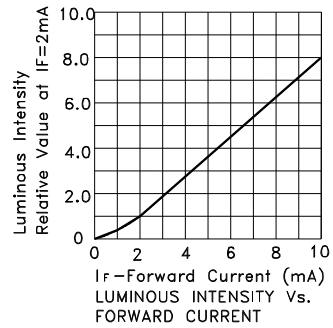
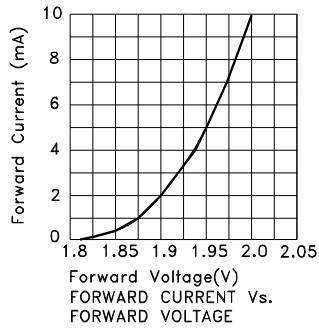

Green

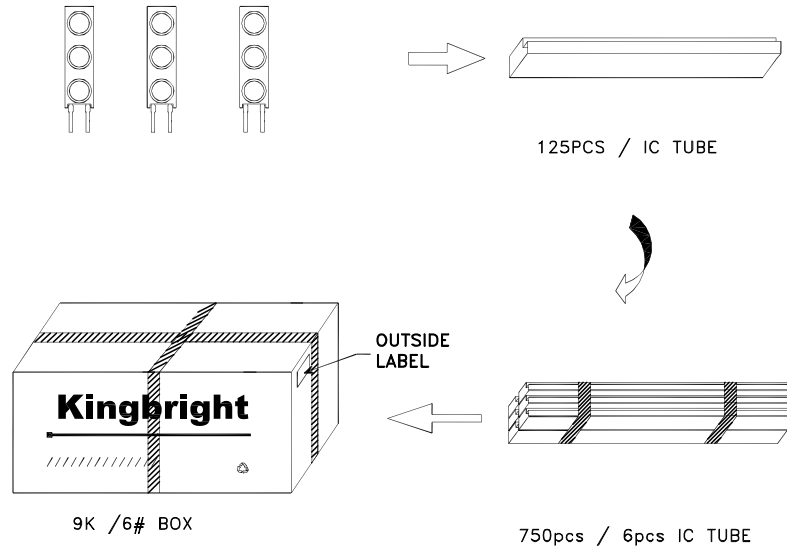

PACKING & LABEL SPECIFICATIONS

WP934SA/LILYLGD



| | |
|-----------------------------------------------------------------------------------------------------------------------------|------------------------------------------------------------------------------------------------------------------|
| Kingbright | |
| P/N0: WP934SAxxx | |
| QTY: 750pcs | Q.C. Q C XX XX XX PASSED |
| S/N: XXXX | |
| CODE: XXX | |
| LOT NO: | |
|  <small>XXXXXXXXXXXXXXXXXXXX</small> | |
| RoHS Compliant | |

Terms and conditions for the usage of this document

1. The information included in this document reflects representative usage scenarios and is intended for technical reference only.
2. The part number, type, and specifications mentioned in this document are subject to future change and improvement without notice. Before production usage customer should refer to the latest datasheet for the updated specifications.
3. When using the products referenced in this document, please make sure the product is being operated within the environmental and electrical limits specified in the datasheet. If customer usage exceeds the specified limits, Kingbright will not be responsible for any subsequent issues.
4. The information in this document applies to typical usage in consumer electronics applications. If customer's application has special reliability requirements or have life-threatening liabilities, such as automotive or medical usage, please consult with Kingbright representative for further assistance.
5. The contents and information of this document may not be reproduced or re-transmitted without permission by Kingbright.
6. All design applications should refer to Kingbright application notes available at <http://www.KingbrightUSA.com/ApplicationNotes>

PRECAUTIONS

1. Storage conditions:

- Avoid continued exposure to the condensing moisture environment and keep the product away from rapid transitions in ambient temperature.
- LEDs should be stored with temperature $\leq 30^{\circ}\text{C}$ and relative humidity $< 60\%$.
- Product in the original sealed package is recommended to be assembled within 72 hours of opening. Product in opened package for more than a week should be baked for 30 (+10/-0) hours at $85 \sim 100^{\circ}\text{C}$.

2. The lead pitch of the LED must match the pitch of the mounting holes on the PCB during component placement. Lead-forming may be required to insure the lead pitch matches the hole pitch. Refer to the figure below for proper lead forming procedures.

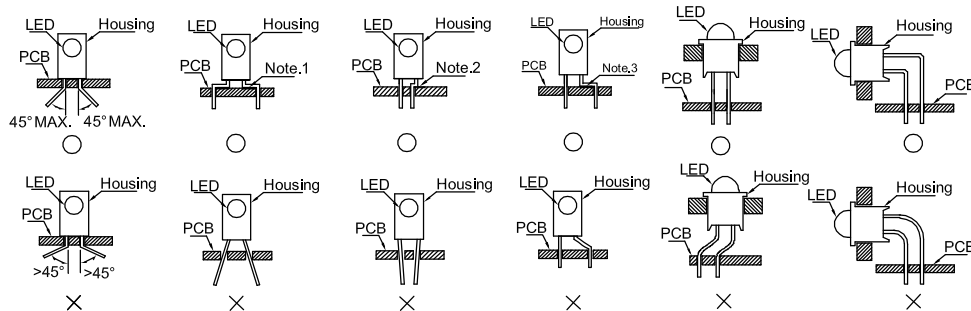

" ○ " Correct mounting method " × " Incorrect mounting method

Note 1-3: Do not route PCB trace in the contact area between the leadframe and the PCB to prevent short-circuits.

3. During soldering, component covers and holders should leave clearance to avoid placing damaging stress on the LED during soldering.

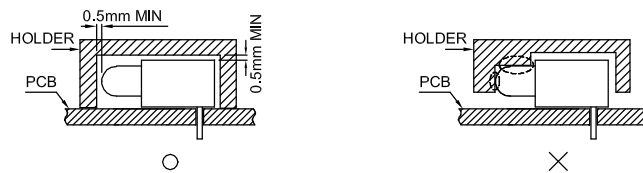

4. The tip of the soldering iron should never touch the lens epoxy.

5. Through-hole LEDs are incompatible with reflow soldering.

6. If the LED will undergo multiple soldering passes or face other processes where the part may be subjected to intense heat, please check with Kingbright for compatibility.

7. Recommended Wave Soldering Profiles:

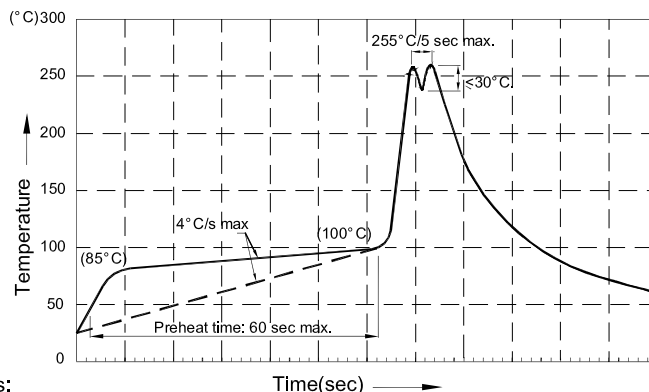

Notes:

- Recommend pre-heat temperature of 105°C or less (as measured with a thermocouple attached to the LED pins) prior to immersion in the solder wave with a maximum solder bath temperature of 260°C
- Peak wave soldering temperature between $245^{\circ}\text{C} \sim 255^{\circ}\text{C}$ for 3 sec (5 sec max).
- Do not apply stress to the epoxy resin while the temperature is above 85°C .
- Fixtures should not incur stress on the component when mounting and during soldering process.
- SAC 305 solder alloy is recommended.
- No more than one wave soldering pass.



Компания «ЭлектроПласт» предлагает заключение долгосрочных отношений при поставках импортных электронных компонентов на взаимовыгодных условиях!

Наши преимущества:

- Оперативные поставки широкого спектра электронных компонентов отечественного и импортного производства напрямую от производителей и с крупнейших мировых складов;
- Поставка более 17-ти миллионов наименований электронных компонентов;
- Поставка сложных, дефицитных, либо снятых с производства позиций;
- Оперативные сроки поставки под заказ (от 5 рабочих дней);
- Экспресс доставка в любую точку России;
- Техническая поддержка проекта, помощь в подборе аналогов, поставка прототипов;
- Система менеджмента качества сертифицирована по Международному стандарту ISO 9001;
- Лицензия ФСБ на осуществление работ с использованием сведений, составляющих государственную тайну;
- Поставка специализированных компонентов (Xilinx, Altera, Analog Devices, Intersil, Interpoint, Microsemi, Aeroflex, Peregrine, Syfer, Eurofarad, Texas Instrument, Miteq, Cobham, E2V, MA-COM, Hittite, Mini-Circuits, General Dynamics и др.);

Помимо этого, одним из направлений компании «ЭлектроПласт» является направление «Источники питания». Мы предлагаем Вам помощь Конструкторского отдела:

- Подбор оптимального решения, техническое обоснование при выборе компонента;
- Подбор аналогов;
- Консультации по применению компонента;
- Поставка образцов и прототипов;
- Техническая поддержка проекта;
- Защита от снятия компонента с производства.



Как с нами связаться

Телефон: 8 (812) 309 58 32 (многоканальный)

Факс: 8 (812) 320-02-42

Электронная почта: org@eplast1.ru

Адрес: 198099, г. Санкт-Петербург, ул. Калинина, дом 2, корпус 4, литера А.