

10 A Snubberless™, logic level and standard Triacs



Features

- Medium current Triac
- Low thermal resistance with clip bonding
- Low thermal resistance insulation ceramic for insulated BTA
- High commutation (4Q) or very high commutation (3Q, Snubberless™) capability
- BTA series UL1557 certified (file ref: 81734)
- Packages are RoHS (2002/95/EC) compliant

Description

Available either in through-hole or surface mount packages, the BTA10, BTB10 and T10xx Triac series are suitable for general purpose mains power AC switching. They can be used as ON/OFF function in applications such as static relays, heating regulation or induction motor starting circuit. They are also recommended for phase control operations in light dimmers and appliance motors speed controllers.

The Snubberless™ versions (W suffix and T10xx) are especially recommended for use on inductive loads, because of their high commutation performance. By using an internal ceramic pad, the Snubberless™ series provide an insulated tab (rated at 2500 V_{RMS}) complying with UL standards (file reference: E81734).

Product status link

[BTA10, BTB10, T1035, T1050](#)

Product summary

| | |
|-------------------|---------------|
| $I_{T(RMS)}$ | 10 A |
| V_{DRM}/V_{RRM} | 600 and 800 V |
| I_{GT} | 25 to 50 mA |

1 Characteristics

Table 1. Absolute maximum ratings

| Symbol | Parameters | | | Value | Unit | |
|-------------------|---|-------------------------|------------------------|-------------------------|-------------|-------------|
| $I_{T(RMS)}$ | RMS on-state current (full sine wave) | TO-220AB | $T_c = 105\text{ °C}$ | 10 | A | |
| | | TO-220AB Ins. | $T_c = 95\text{ °C}$ | | | |
| I_{TSM} | Non repetitive surge peak on-state current (full cycle, T_j initial = 25 °C) | F = 50 Hz | $t_p = 20\text{ ms}$ | 100 | A | |
| | | F = 60 Hz | $t_p = 16.7\text{ ms}$ | 105 | | |
| I^2t | I^2t value for fusing | $t_p = 10\text{ ms}$ | | 55 | A^2s | |
| di/dt | Critical rate of rise of on-state current $I_G = 2 \times I_{GT}$, $t_r \leq 100\text{ ns}$ | F = 120 Hz | $T_j = 125\text{ °C}$ | 50 | $A/\mu s$ | |
| V_{DSM}/V_{RSM} | Non repetitive surge peak off-state voltage | $t_p = 10\text{ ms}$ | $T_j = 25\text{ °C}$ | $V_{DRM}/V_{RRM} + 100$ | V | |
| I_{GM} | Peak gate current | $t_p = 20\text{ }\mu s$ | $T_j = 125\text{ °C}$ | 4 | A | |
| $P_{G(AV)}$ | Average gate power dissipation | $T_j = 125\text{ °C}$ | | 1 | W | |
| T_{stg} | Storage junction temperature range | | | | -40 to +150 | $^{\circ}C$ |
| T_j | Operating junction temperature range | | | | -40 to +125 | $^{\circ}C$ |

Table 2. Static electrical characteristics

| Symbol | Test conditions | T_j | | Value | Unit |
|-------------------|---|-----------------|------|-------|-----------|
| $V_T^{(1)}$ | $I_{TM} = 14\text{ A}$, $t_p = 380\text{ }\mu s$ | 25 °C | Max. | 1.55 | V |
| V_{TO} | threshold on-state voltage | 125 °C | Max. | 0.85 | V |
| R_D | Dynamic resistance | 125 °C | Max. | 40 | $m\Omega$ |
| I_{DRM}/I_{RRM} | $V_{DRM} = V_{RRM}$ | 25 °C | Max. | 5 | μA |
| | | 125 °C | | 1 | mA |

1. For both polarities of A2 referenced to A1

Table 3. Electrical characteristics ($T_j = 25\text{ °C}$, unless otherwise specified) - Snubberless™ (3 quadrants)

| Symbol | Parameters | Quadrant | | T1035 | BTA10-xCW BTB10-xCW | T1050 BTA10-xBW BTB10-xBW | Unit |
|---------------|--|--------------|------|-------|------------------------|---------------------------------|-----------|
| | | | | | | | |
| I_{GT} | $V_D = 12\text{ V}$, $R_L = 33\text{ }\Omega$ | I - II - III | Max. | 35 | | 50 | mA |
| V_{GT} | | I - II - III | Max. | 1.3 | | | V |
| V_{GD} | $V_D = V_{DRM}$, $R_L = 3,3\text{ k}\Omega$, $T_j = 125\text{ °C}$ | I - II - III | Min. | 0.2 | | | V |
| I_H | $I_T = 500\text{ mA}$ | I - II - III | Max. | 35 | | 50 | mA |
| I_L | $I_G = 1.2 I_{GT}$ | I - III | Max. | 50 | | 70 | mA |
| | | II | Max. | 80 | 60 | 80 | |
| $dV/dt^{(2)}$ | $V_D = 67\% V_{DRM}$ gate open, $T_j = 125\text{ °C}$ | | Min. | 500 | | 1000 | $V/\mu s$ |

| Symbol | Parameters | Quadrant | | T1035 | BTA10-xCW BTB10-xCW | T1050 BTA10-xBW BTB10-xBW | Unit |
|-------------------|--|----------|------|-------|------------------------|---------------------------------|------|
| $(di/dt)_c^{(2)}$ | Without snubber, $T_j = 125\text{ °C}$ | | Min. | 5.5 | | 9 | A/ms |

1. Minimum I_{GT} is guaranteed at 5 % of I_{GT} max.
2. For both polarities of A2 referenced to A1

Table 4. Electrical characteristics ($T_j = 25\text{ °C}$, unless otherwise specified) - standard Triac (4 quadrants)

| Symbol | Parameters | Quadrant | | Value | | Unit |
|-------------------|--|--------------|------|-------|-----|------------|
| | | | | C | B | |
| $I_{GT}^{(1)}$ | $V_D = 12\text{ V}$, $R_L = 33\ \Omega$ | I - II - III | Max. | 25 | 50 | mA |
| | | IV | Max. | 50 | 100 | |
| V_{GT} | | All | Max. | 1.3 | | V |
| V_{GD} | $V_D = V_{DRM}$, $R_L = 3,3\text{ k}\Omega$, $T_j = 125\text{ °C}$ | I - II - III | Min. | 0.2 | | V |
| $I_H^{(2)}$ | $I_T = 500\text{ mA}$ | I - II - III | Max. | 25 | 50 | mA |
| I_L | $I_G = 1.2\ I_{GT}$ | I - III | Max. | 40 | 50 | mA |
| | | II | Max. | 80 | 100 | |
| $dV/dt^{(2)}$ | $V_D = 67\% V_{DRM}$ gate open, $T_j = 125\text{ °C}$ | | Min. | 200 | 400 | V/ μ s |
| $(dV/dt)_c^{(2)}$ | $(di/dt)_c = 4.4\text{ A/ms}$, $T_j = 125\text{ °C}$ | | Min. | 5 | 10 | V/ μ s |

1. Minimum I_{GT} is guaranteed at 5 % of I_{GT} max.
2. For both polarities of A2 referenced to A1

Table 5. Thermal resistance

| Symbol | Parameters | Value | Unit |
|----------------------|---|-------------------------------|------|
| $R_{th(j-c)}$ (typ.) | Junction to case (AC) | TO-220AB / D ² PAK | 1.5 |
| | | TO-220AB insulated | 2.4 |
| $R_{th(j-a)}$ (max.) | Junction to ambient ($S^{(1)} = 2\text{ cm}^2$) | D ² PAK | 45 |
| | Junction to ambient | TO-220AB / TO-220AB ins | 60 |

1. Copper surface under tab.

1.1 Characteristics (curves)
Figure 2. Maximum power dissipation versus on-state RMS current (full cycle)

Figure 3. RMS on-state current cycle versus case temperature (full cycle)

Figure 4. Relative variation of thermal impedance versus pulse duration

Figure 5. On-state characteristics (maximum values)

Figure 6. Surge peak on-state current versus number of cycles

Figure 7. Non repetitive surge peak on-state current versus sinusoidal pulse width (tp < 10 ms)

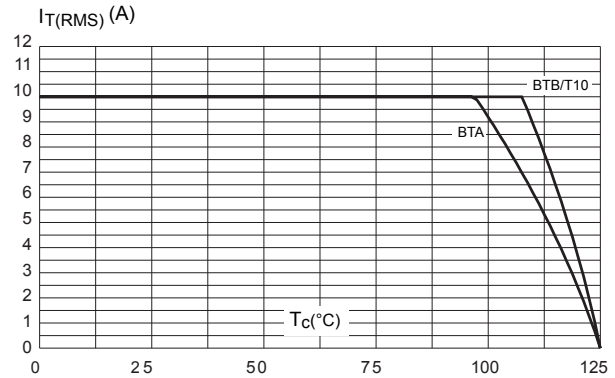
Figure 8. Relative variation of gate trigger current, holding current and latching current versus junction temperature (typical values)

Figure 9. Relative variation of critical rate of decrease of main current versus $(dV/dt)_c$ (typical values)

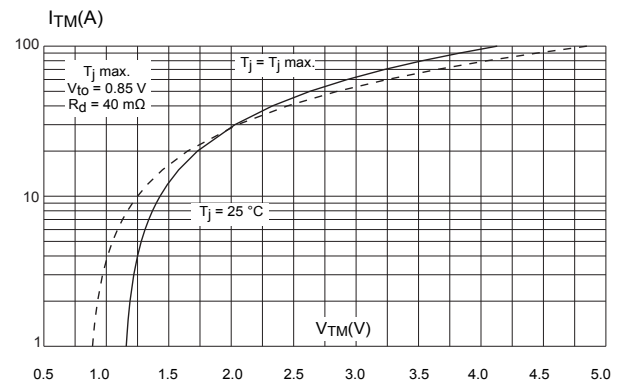
Figure 10. Relative variation of critical rate of decrease of main current versus junction temperature

Figure 11. D²PAK thermal resistance junction to ambient versus copper surface under tab

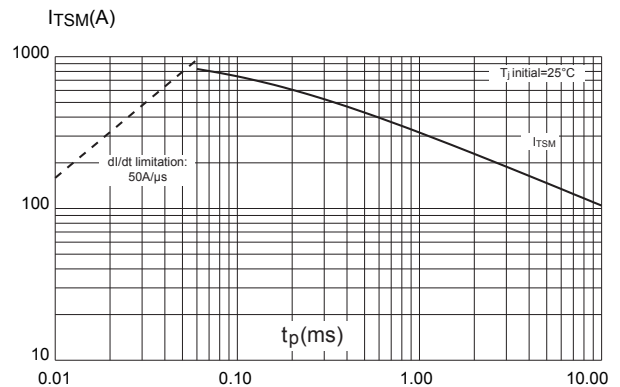
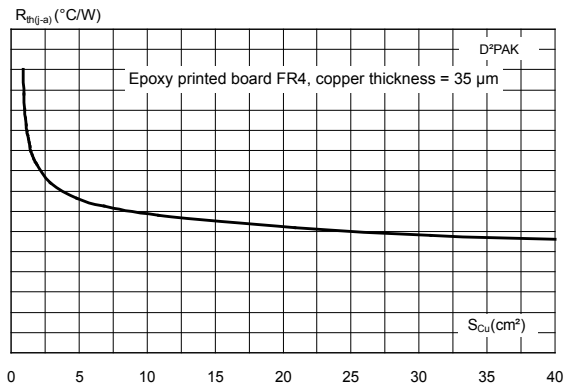
2 Package information

In order to meet environmental requirements, ST offers these devices in different grades of **ECOPACK®** packages, depending on their level of environmental compliance. ECOPACK® specifications, grade definitions and product status are available at: www.st.com. ECOPACK® is an ST trademark.

2.1 D²PAK package information

Figure 12. D²PAK package outline

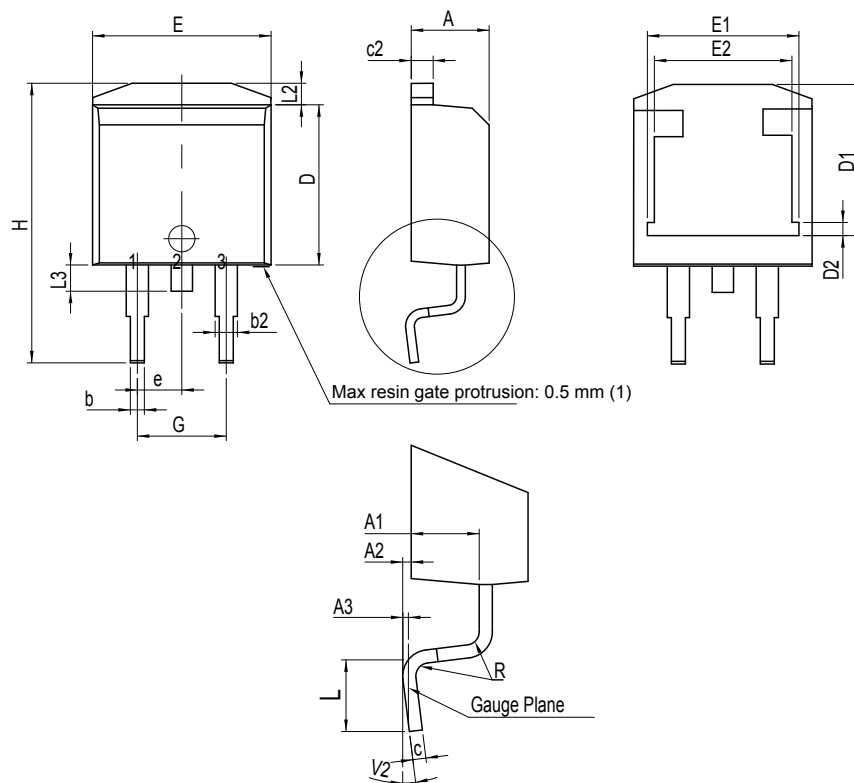

(1) Resin gate is accepted in each of position shown on the drawing, or their symmetrical.

Table 6. D²PAK package mechanical data

| Ref. | Dimensions | | | | | |
|------|-------------|------|------|-----------------------|--------|--------|
| | Millimeters | | | Inches ⁽¹⁾ | | |
| | Min. | Typ. | Max. | Min. | Typ. | Max. |
| A | 4.30 | | 4.60 | 0.1693 | | 0.1811 |
| A1 | 2.49 | | 2.69 | 0.0980 | | 0.1059 |
| A2 | 0.03 | | 0.23 | 0.0012 | | 0.0091 |
| A3 | | 0.25 | | | 0.0098 | |
| b | 0.70 | | 0.93 | 0.0276 | | 0.0366 |
| b2 | 1.25 | | 1.7 | 0.0492 | | 0.0669 |

| Ref. | Dimensions | | | | | |
|------|-------------|------|-------|-----------------------|--------|--------|
| | Millimeters | | | Inches ⁽¹⁾ | | |
| | Min. | Typ. | Max. | Min. | Typ. | Max. |
| c | 0.45 | | 0.60 | 0.0177 | | 0.0236 |
| c2 | 1.21 | | 1.36 | 0.0476 | | 0.0535 |
| D | 8.95 | | 9.35 | 0.3524 | | 0.3681 |
| D1 | 7.50 | | 8.00 | 0.2953 | | 0.3150 |
| D2 | 1.30 | | 1.70 | 0.0512 | | 0.0669 |
| e | 2.54 | | | 0.1 | | |
| E | 10.00 | | 10.28 | 0.3937 | | 0.4047 |
| E1 | 8.30 | | 8.70 | 0.3268 | | 0.3425 |
| E2 | 6.85 | | 7.25 | 0.2697 | | 0.2854 |
| G | 4.88 | | 5.28 | 0.1921 | | 0.2079 |
| H | 15 | | 15.85 | 0.5906 | | 0.6240 |
| L | 1.78 | | 2.28 | 0.0701 | | 0.0898 |
| L2 | 1.27 | | 1.40 | 0.0500 | | 0.0551 |
| L3 | 1.40 | | 1.75 | 0.0551 | | 0.0689 |
| R | | 0.40 | | | 0.0157 | |
| V2 | 0° | | 8° | 0° | | 8° |

1. Dimensions in inches are given for reference only

Figure 13. D²PAK recommended footprint (dimensions are in mm)

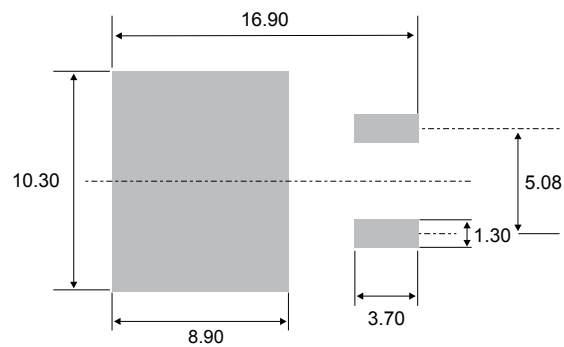

2.2 TO-220AB non ins. and insulated package information

Figure 14. TO-220AB non ins. and insulated package outline

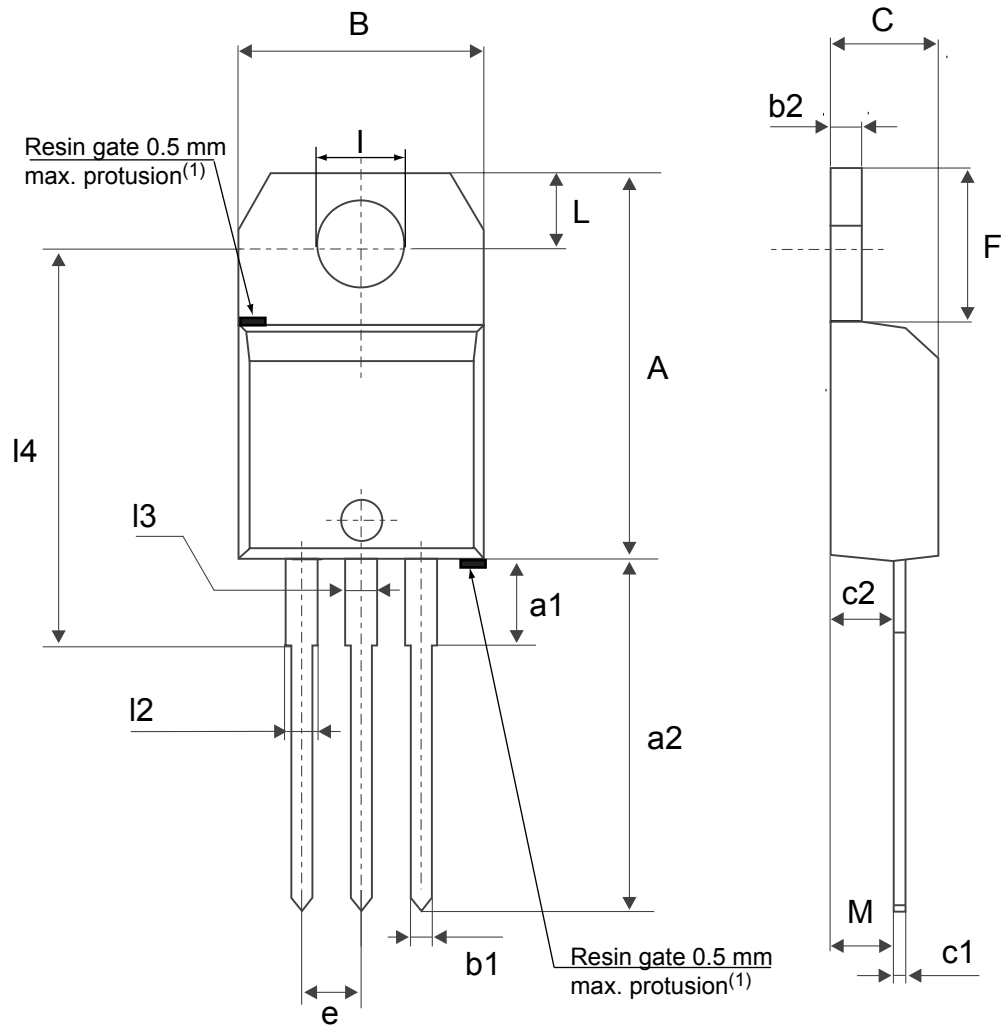

(1)Resin gate position accepted in one of the two positions or in the symmetrical opposites.

Table 7. TO-220AB non ins. and insulated package mechanical data

| Ref. | Dimensions | | | | | |
|------|-------------|------|-------|---------------------|--------|--------|
| | Millimeters | | | Inches ¹ | | |
| | Min. | Typ. | Max. | Min. | Typ. | Max. |
| A | 15.20 | | 15.90 | 0.5984 | | 0.6260 |
| a1 | | 3.75 | | | 0.1476 | |
| a2 | 13.00 | | 14.00 | 0.5118 | | 0.5512 |
| B | 10.00 | | 10.40 | 0.3937 | | 0.4094 |
| b1 | 0.61 | | 0.88 | 0.0240 | | 0.0346 |
| b2 | 1.23 | | 1.32 | 0.0484 | | 0.0520 |
| C | 4.40 | | 4.60 | 0.1732 | | 0.1811 |

| Ref. | Dimensions | | | | | |
|------|-------------|-------|-------|---------------------|--------|--------|
| | Millimeters | | | Inches ¹ | | |
| | Min. | Typ. | Max. | Min. | Typ. | Max. |
| c1 | 0.49 | | 0.70 | 0.0193 | | 0.0276 |
| c2 | 2.40 | | 2.72 | 0.0945 | | 0.1071 |
| e | 2.40 | | 2.70 | 0.0945 | | 0.1063 |
| F | 6.20 | | 6.60 | 0.2441 | | 0.2598 |
| l | 3.73 | | 3.88 | 0.1469 | | 0.1528 |
| L | 2.65 | | 2.95 | 0.1043 | | 0.1161 |
| l2 | 1.14 | | 1.70 | 0.0449 | | 0.0669 |
| l3 | 1.14 | | 1.70 | 0.0449 | | 0.0669 |
| l4 | 15.80 | 16.40 | 16.80 | 0.6220 | 0.6457 | 0.6614 |
| M | | 2.6 | | | 0.1024 | |

1. Inch dimensions are for reference only.

3 Ordering information

Figure 15. BTA10 and BTB10 series ordering information scheme

Figure 16. T10xx series ordering information scheme

Table 8. Ordering information

| Order code | Marking | Package | Weight | Base qty. | Delivery mode |
|---------------|-------------|--------------------|--------|-----------|-------------------|
| BTA10-600BRG | BTA10-600B | TO-220AB Ins. | 2.3 g | 50 | Tube |
| BTA10-600CRG | BTA10-600C | | | | |
| BTA10-600BWRG | BTA10-600BW | | | | |
| BTA10-600CWRG | BTA10-600CW | | | | |
| BTA10-800BWRG | BTA10-800BW | | | | |
| BTA10-800CWRG | BTA10-800CW | | | | |
| BTB10-600BWRG | BTB10-600BW | TO-220AB | | | |
| BTB10-800BWRG | BTB10-800BW | | | | |
| T1035-6G | T1035-6G | D ² PAK | 1.50 g | | Tape and reel 13" |
| T1050-8G | T1050-8G | | | | |
| T1035-6G-TR | T1035-6G | | | 1000 | |
| T1050-8G-TR | T1050-8G | | | | |

Revision history

Table 9. Document revision history

| Date | Revision | Changes |
|-------------|----------|--|
| Sep-2002 | 5A | Last update. |
| 13-Feb-2006 | 6 | TO-220AB delivery mode changed from bulk to tube. ECOPACK statement added. |
| 06-Feb-2017 | 7 | Added D ² PAK package information. |
| 15-Mar-2018 | 8 | Updated Table 3. Electrical characteristics (T _J = 25 °C, unless otherwise specified) - Snubberless™ (3 quadrants), Section 3 Ordering information and Section 2.1 D ² PAK package information. Added RPNs T1035 and T1050. |
| 01-Mar-2019 | 9 | Updated Links syntax. |

IMPORTANT NOTICE – PLEASE READ CAREFULLY

STMicroelectronics NV and its subsidiaries (“ST”) reserve the right to make changes, corrections, enhancements, modifications, and improvements to ST products and/or to this document at any time without notice. Purchasers should obtain the latest relevant information on ST products before placing orders. ST products are sold pursuant to ST’s terms and conditions of sale in place at the time of order acknowledgement.

Purchasers are solely responsible for the choice, selection, and use of ST products and ST assumes no liability for application assistance or the design of Purchasers’ products.

No license, express or implied, to any intellectual property right is granted by ST herein.

Resale of ST products with provisions different from the information set forth herein shall void any warranty granted by ST for such product.

ST and the ST logo are trademarks of ST. All other product or service names are the property of their respective owners.

Information in this document supersedes and replaces information previously supplied in any prior versions of this document.

© 2019 STMicroelectronics – All rights reserved



Компания «ЭлектроПласт» предлагает заключение долгосрочных отношений при поставках импортных электронных компонентов на взаимовыгодных условиях!

Наши преимущества:

- Оперативные поставки широкого спектра электронных компонентов отечественного и импортного производства напрямую от производителей и с крупнейших мировых складов;
- Поставка более 17-ти миллионов наименований электронных компонентов;
- Поставка сложных, дефицитных, либо снятых с производства позиций;
- Оперативные сроки поставки под заказ (от 5 рабочих дней);
- Экспресс доставка в любую точку России;
- Техническая поддержка проекта, помощь в подборе аналогов, поставка прототипов;
- Система менеджмента качества сертифицирована по Международному стандарту ISO 9001;
- Лицензия ФСБ на осуществление работ с использованием сведений, составляющих государственную тайну;
- Поставка специализированных компонентов (Xilinx, Altera, Analog Devices, Intersil, Interpoint, Microsemi, Aeroflex, Peregrine, Syfer, Eurofarad, Texas Instrument, Miteq, Cobham, E2V, MA-COM, Hittite, Mini-Circuits, General Dynamics и др.);

Помимо этого, одним из направлений компании «ЭлектроПласт» является направление «Источники питания». Мы предлагаем Вам помощь Конструкторского отдела:

- Подбор оптимального решения, техническое обоснование при выборе компонента;
- Подбор аналогов;
- Консультации по применению компонента;
- Поставка образцов и прототипов;
- Техническая поддержка проекта;
- Защита от снятия компонента с производства.



Как с нами связаться

Телефон: 8 (812) 309 58 32 (многоканальный)

Факс: 8 (812) 320-02-42

Электронная почта: org@eplast1.ru

Адрес: 198099, г. Санкт-Петербург, ул. Калинина, дом 2, корпус 4, литера А.