

FEATURES

High performance, dual-axis accelerometer on a single IC
 -40°C to $+175^{\circ}\text{C}$ ambient temperature range
Long life: guaranteed 1000 hours at $T_A = 175^{\circ}\text{C}$
13 mm \times 8 mm \times 2 mm side-brazed ceramic dual in-line package
1 mg resolution at 60 Hz
Low power: 700 μA at $V_S = 5\text{ V}$ (typical)
High zero g bias repeatability
High sensitivity accuracy
Bandwidth adjustment with a single capacitor
Single-supply operation
RoHS-compliant
Compatible with Sn/Pb and Pb-free solder processes

APPLICATIONS

Geological exploration tilt and vibration measurement
Extreme high temperature industrial products

GENERAL DESCRIPTION

The **ADXL206** is a precision, low power, complete dual-axis *i*MEMS[®] accelerometer for use in high temperature environments. The accelerometer integrates the sensor with signal conditioned voltage outputs on a single, monolithic IC.

The ADXL206 measures acceleration with a full-scale range of $\pm 5 g$. The ADXL206 can measure both dynamic acceleration (for example, vibration) and static acceleration (for example, gravity).

The typical noise floor is $110 \mu\text{g}/\sqrt{\text{Hz}}$, allowing signals below 1 mg (0.06° of inclination) to be resolved in tilt sensing applications using narrow bandwidths ($<60\text{ Hz}$).

The user selects the bandwidth of the accelerometer using Capacitors C_X and C_Y at the X_{OUT} and Y_{OUT} pins, respectively. Bandwidths of 0.5 Hz to 2.5 kHz can be selected to suit the application.

The ADXL206 is available in a 13 mm \times 8 mm \times 2 mm, 8-lead, side-brazed ceramic dual in-line package (SBDIP).

FUNCTIONAL BLOCK DIAGRAM

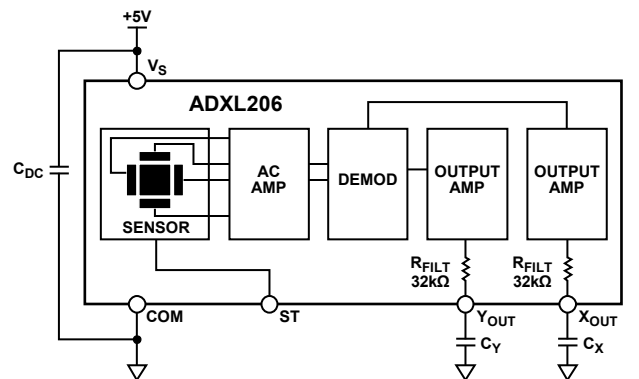

Figure 1.

Rev. 0

Information furnished by Analog Devices is believed to be accurate and reliable. However, no responsibility is assumed by Analog Devices for its use, nor for any infringements of patents or other rights of third parties that may result from its use. Specifications subject to change without notice. No license is granted by implication or otherwise under any patent or patent rights of Analog Devices. Trademarks and registered trademarks are the property of their respective owners.

TABLE OF CONTENTS

Features	1	Theory of Operation	9
Applications.....	1	Performance	9
General Description	1	Applications Information	10
Functional Block Diagram	1	Power Supply Decoupling	10
Revision History	2	Setting the Bandwidth Using C_X and C_Y	10
Specifications.....	3	Self-Test	10
Absolute Maximum Ratings.....	4	Design Trade-Offs for Selecting Filter Characteristics: Noise/Bandwidth Trade-Off.....	10
Thermal Resistance	4	Using the ADXL206 with Operating Voltages Other Than 5 V	11
ESD Caution.....	4	Using the ADXL206 As a Dual-Axis Tilt Sensor	11
Pin Configuration and Function Descriptions.....	5	Outline Dimensions	12
Typical Performance Characteristics	6	Ordering Guide	12

REVISION HISTORY

4/11—Revision 0: Initial Version

SPECIFICATIONS

$T_A = -40^{\circ}\text{C}$ to $+175^{\circ}\text{C}$, $V_S = 5\text{ V}$, $C_X = 0.1\ \mu\text{F}$, acceleration = 0 g , unless otherwise noted.¹

Table 1.

Parameter	Test Conditions/Comments	Min	Typ	Max	Unit
SENSOR INPUT	Each axis				
Measurement Range ²		±5			g
Nonlinearity			±0.2		% FS
Package Alignment Error			±1		Degrees
Alignment Error	X sensor to Y sensor		±0.1		Degrees
Cross-Axis Sensitivity			±1.5		%
SENSITIVITY (RATIOMETRIC) ³					
Sensitivity at X_{OUT} , Y_{OUT}	$V_S = 5\text{ V}$	296	312	328	mV/g
Sensitivity Change Due to Temperature ⁴	$V_S = 5\text{ V}$		±0.3		%
ZERO g BIAS LEVEL (RATIOMETRIC)					
0 g Voltage at X_{OUT} , Y_{OUT}	$V_S = 5\text{ V}$, $T_A = 25^{\circ}\text{C}$		2.5 ± 0.025		V
0 g Bias Repeatability	$-40^{\circ}\text{C} \leq T_A \leq +175^{\circ}\text{C}$		±10		mg
NOISE PERFORMANCE					
Noise Density	$V_S = 5\text{ V}$, $T_A = 25^{\circ}\text{C}$		110		$\mu\text{g}/\sqrt{\text{Hz}}$ rms
FREQUENCY RESPONSE ⁵					
C_X , C_Y Range ⁶		0.002		10	μF
R_{FILT} Tolerance		24	32	40	k Ω
Sensor Resonant Frequency			5.5		kHz
SELF-TEST ⁷					
Logic Input Low				1	V
Logic Input High		4			V
ST Input Resistance to Ground		30	50		k Ω
Output Change at X_{OUT} , Y_{OUT}	ST pin Logic 0 to Logic 1	150	250	350	mV
OUTPUT AMPLIFIER	No load				
Output Swing Low		0.05	0.2		V
Output Swing High			4.5		V
LIFESPAN					
Usable Life Expectancy	$T_A = 175^{\circ}\text{C}$	1000			Hours
POWER SUPPLY					
Operating Voltage Range		4.75		5.25	V
Supply Current			0.7	1.5	mA
Turn-On Time ⁸			20		ms

¹ Minimum and maximum specifications are guaranteed. Typical specifications are not guaranteed.

² Guaranteed by measurement of initial offset and sensitivity.

³ Sensitivity is essentially ratiometric to V_S . For $V_S = 4.75\text{ V}$ to 5.25 V , sensitivity is 186 mV/V/g to 215 mV/V/g .

⁴ Defined as the output change from ambient temperature to maximum temperature or from ambient temperature to minimum temperature.

⁵ Actual frequency response controlled by user-supplied external capacitors (C_X , C_Y).

⁶ Bandwidth = $1/(2 \times \pi \times 32\text{ k}\Omega \times C)$. For C_X , $C_Y = 0.002\ \mu\text{F}$, bandwidth = 2500 Hz . For C_X , $C_Y = 10\ \mu\text{F}$, bandwidth = 0.5 Hz . Minimum/maximum values are not tested.

⁷ Self-test response changes cubically with V_S .

⁸ Larger values of C_X , C_Y increase turn-on time. Turn-on time is approximately $160 \times C_X$ or $C_Y + 4\text{ ms}$, where C_X and C_Y are in microfarads (μF).

ABSOLUTE MAXIMUM RATINGS

Table 2.

Parameter	Rating
Acceleration (Any Axis)	
Unpowered	500 g
Powered	500 g
V_S	-0.3 V to +7.0 V
All Other Pins	(COM - 0.3 V) to ($V_S + 0.3$ V)
Output Short-Circuit Duration (Any Pin to Common)	Indefinite
Ambient Operating Temperature Range (T_A)	-55°C to +175°C
Storage Temperature Range	-65°C to +200°C

Stresses above those listed under Absolute Maximum Ratings may cause permanent damage to the device. This is a stress rating only; functional operation of the device at these or any other conditions above those indicated in the operational section of this specification is not implied. Exposure to absolute maximum rating conditions for extended periods may affect device reliability.

THERMAL RESISTANCE

θ_{JA} is specified for the worst-case conditions, that is, for a device soldered in a printed circuit board (PCB) for surface-mount packages.

Table 3. Thermal Resistance

Package Type	θ_{JA}	θ_{JC}	Unit
8-Lead SBDIP	120	20	°C/W

ESD CAUTION



ESD (electrostatic discharge) sensitive device. Charged devices and circuit boards can discharge without detection. Although this product features patented or proprietary protection circuitry, damage may occur on devices subjected to high energy ESD. Therefore, proper ESD precautions should be taken to avoid performance degradation or loss of functionality.

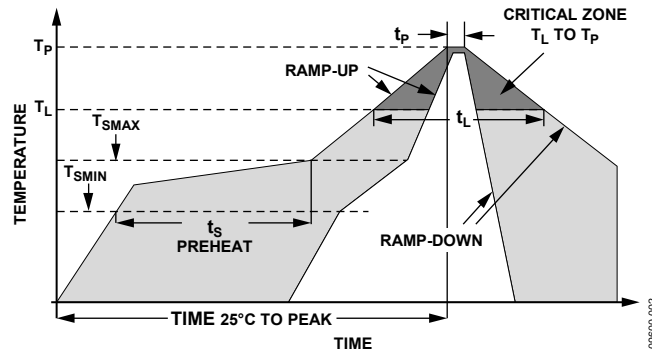
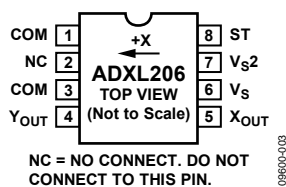

Figure 2. Recommended Soldering Profile

Table 4. Recommended Soldering Profile Limits

Profile Feature	Sn63/Pb37	Pb-Free
Average Ramp Rate (T_L to T_P)	3°C/sec max	3°C/sec max
Preheat		
Minimum Temperature (T_{SMIN})	100°C	150°C
Maximum Temperature (T_{SMAX})	150°C	200°C
Time (T_{SMIN} to T_{SMAX}), t_S	60 sec to 120 sec	60 sec to 150 sec
Ramp-Up Rate (T_{SMAX} to T_L)	3°C/sec max	3°C/sec max
Time Maintained Above Liquidous (t_L)	60 sec to 150 sec	60 sec to 150 sec
Liquidous Temperature (T_L)	183°C	217°C
Peak Temperature (T_P)	240°C + 0°C/-5°C	260°C + 0°C/-5°C
Time Within 5°C of Actual Peak Temperature (t_P)	10 sec to 30 sec	20 sec to 40 sec
Ramp-Down Rate (T_P to T_L)	6°C/sec max	6°C/sec max
Time 25°C to Peak Temperature	6 minutes max	8 minutes max

PIN CONFIGURATION AND FUNCTION DESCRIPTIONS



NC = NO CONNECT. DO NOT CONNECT TO THIS PIN.

Figure 3. Pin Configuration

Table 5. Pin Function Descriptions

Pin No.	Mnemonic	Description
1, 3	COM	Common.
2	NC	No Connect. Do not connect to this pin.
4	Y _{OUT}	Y Channel Output.
5	X _{OUT}	X Channel Output.
6	V _S	Supply.
7	V _{S2}	Supply. Must be connected to V _S .
8	ST	Self-Test.

TYPICAL PERFORMANCE CHARACTERISTICS

$V_s = 5\text{ V}$, unless otherwise noted.

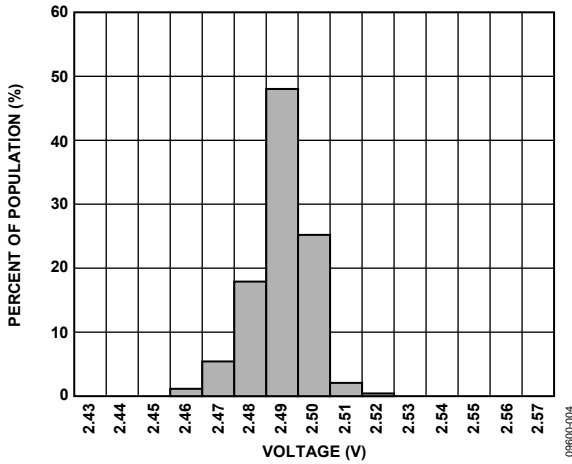

Figure 4. X-Axis Zero g Bias at $T_A = 25^\circ\text{C}$

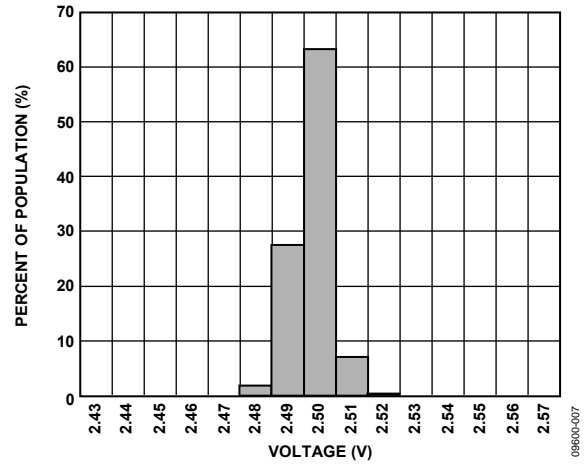

Figure 7. Y-Axis Zero g Bias at $T_A = 25^\circ\text{C}$

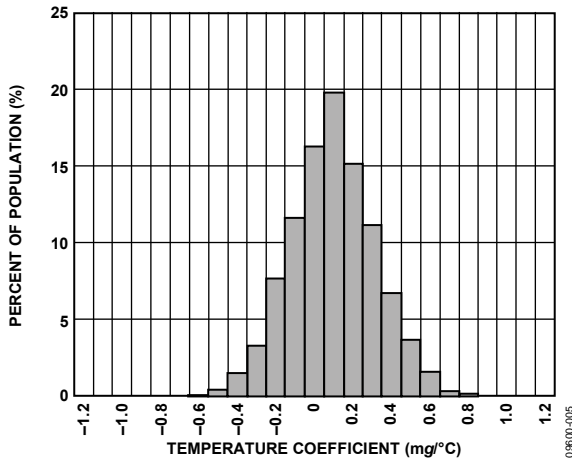

Figure 5. X-Axis Zero g Bias Temperature Coefficient

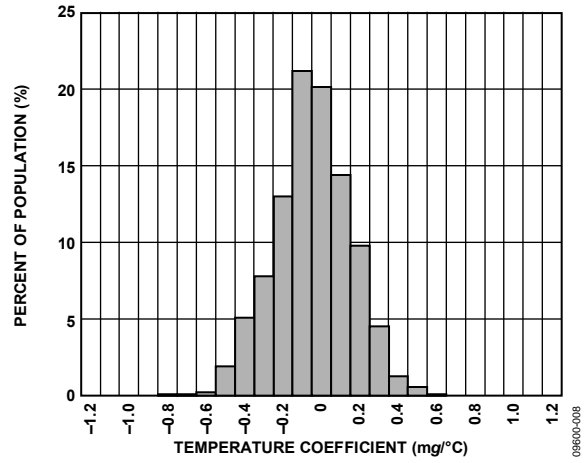

Figure 8. Y-Axis Zero g Bias Temperature Coefficient

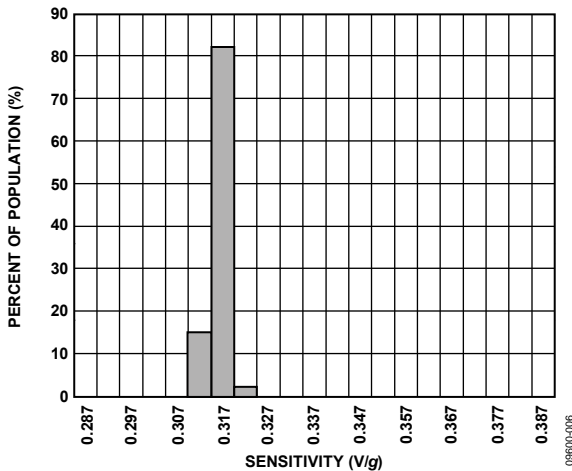

Figure 6. X-Axis Sensitivity at $T_A = 25^\circ\text{C}$

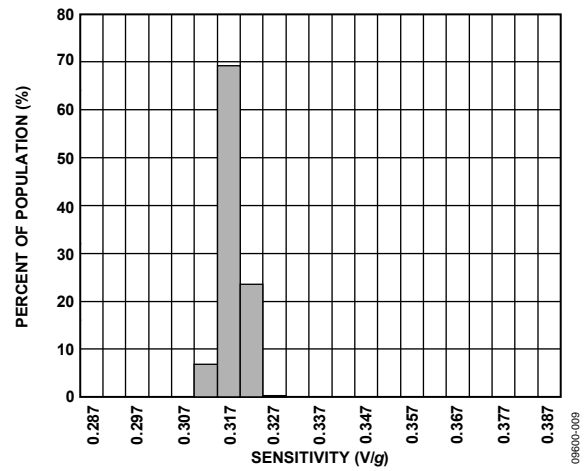

Figure 9. Y-Axis Sensitivity at $T_A = 25^\circ\text{C}$

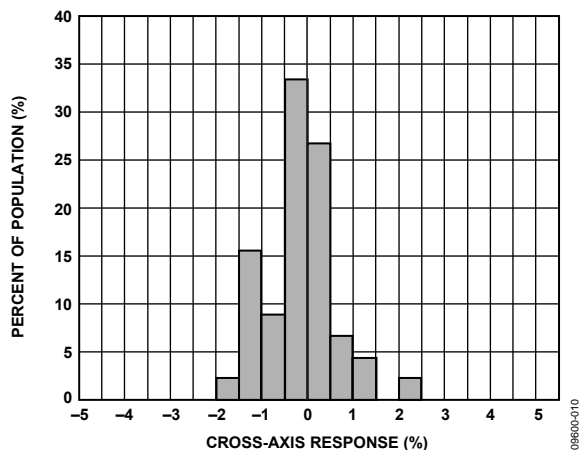

Figure 10. Cross-Axis Response, Z-Axis vs. X-Axis

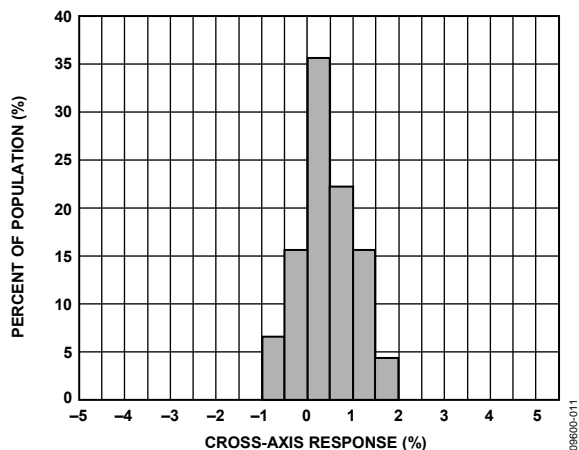

Figure 13. Cross-Axis Response, Z-Axis vs. Y-Axis

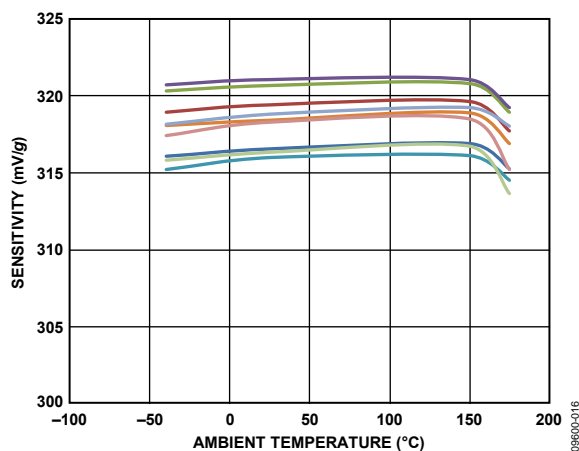

Figure 11. X-Axis Sensitivity over Temperature, Nine Devices

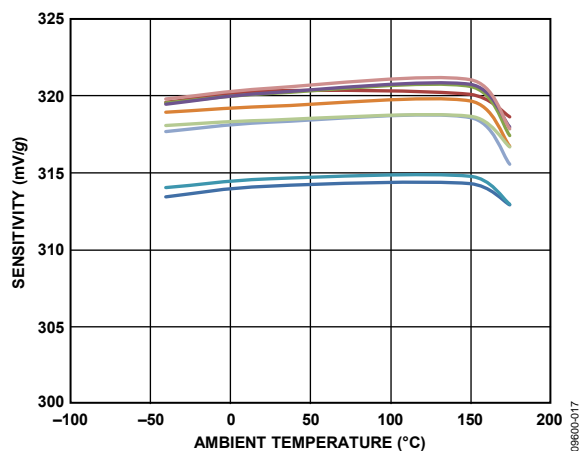

Figure 14. Y-Axis Sensitivity over Temperature, Nine Devices

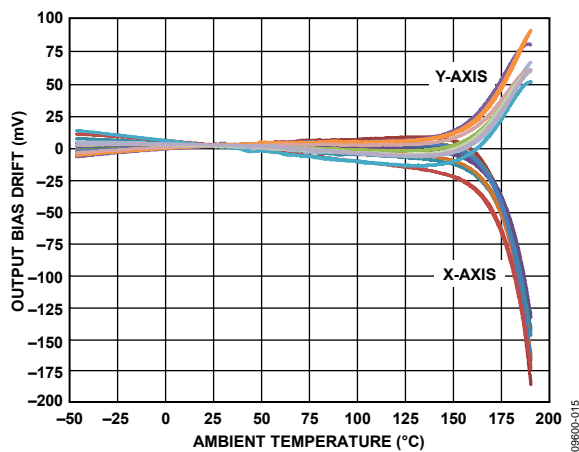

Figure 12. Zero g Output Bias Drift over Temperature, Eight Devices

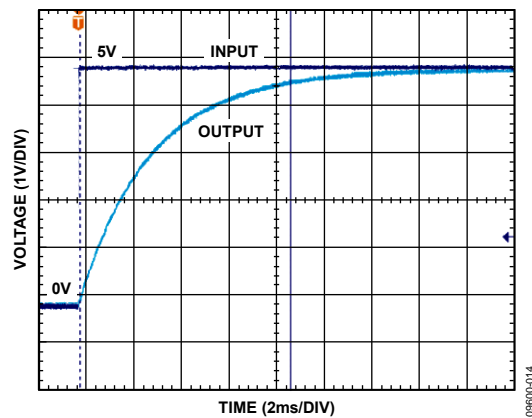

Figure 15. Turn-On Time, $C_X, C_Y = 0.1 \mu F$, Time Scale = 2 ms/div

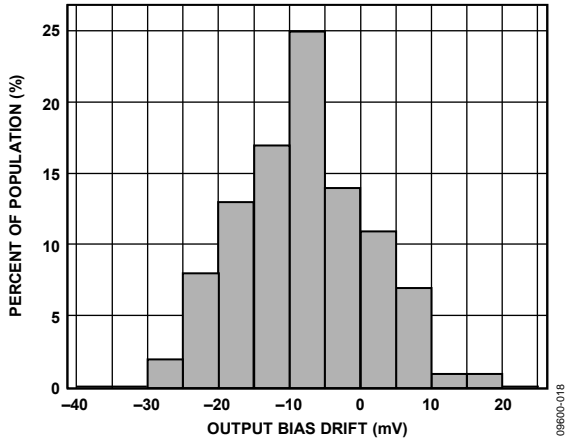

Figure 16. X-Axis Zero g Output Bias Drift over 1000 Hours at $T_A = 175^\circ\text{C}$, Powered

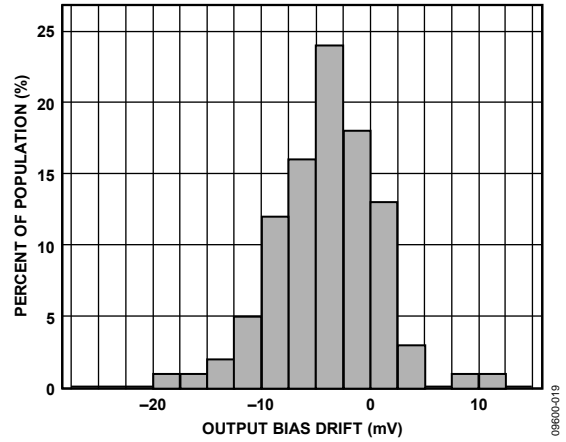

Figure 18. Y-Axis Zero g Output Bias Drift over 1000 Hours at $T_A = 175^\circ\text{C}$, Powered

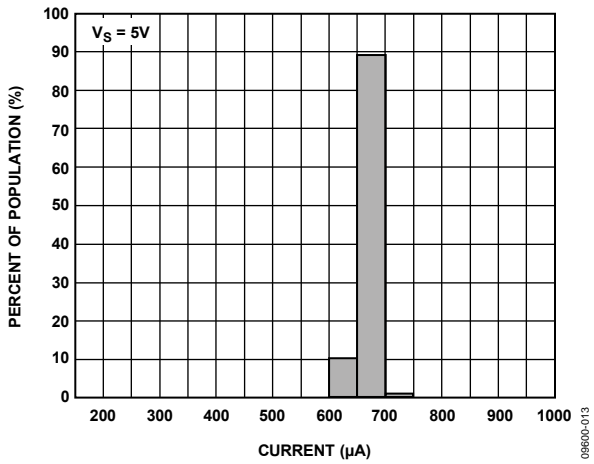

Figure 17. Supply Current at $T_A = 25^\circ\text{C}$

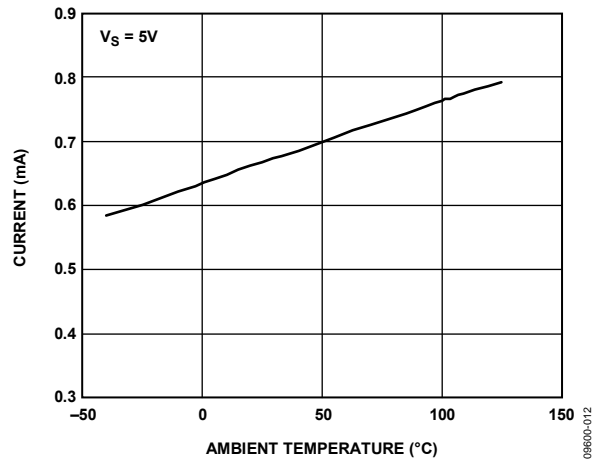

Figure 19. Supply Current vs. Temperature

THEORY OF OPERATION

The ADXL206 is a complete acceleration measurement system on a single, monolithic IC. The part contains a polysilicon, surface-micromachined sensor and signal conditioning circuitry to implement an open-loop acceleration measurement architecture. The output signals are analog voltages proportional to acceleration. The ADXL206 is capable of measuring both positive and negative accelerations to at least $\pm 5 g$. The accelerometer can measure static acceleration forces such as gravity, allowing it to be used as a tilt sensor.

The sensor is a surface-micromachined, polysilicon structure built on top of the silicon wafer. Polysilicon springs suspend the structure over the surface of the wafer and provide resistance against acceleration forces. Deflection of the structure is measured using a differential capacitor that consists of independent fixed plates and plates attached to the moving mass. The fixed plates are driven by 180° out-of-phase square waves. Acceleration deflects the beam and unbalances the differential capacitor, resulting in an output square wave whose amplitude is proportional to acceleration. Phase-sensitive demodulation techniques are then used to rectify the signal and determine the direction of the acceleration.

The output of the demodulator is amplified and brought off chip through a $32 k\Omega$ resistor. At this point, the user can set the signal bandwidth of the device by adding a capacitor. This filtering improves measurement resolution and helps prevent aliasing.

PERFORMANCE

Rather than using additional temperature compensation circuitry, innovative design techniques have been used to ensure that high performance is built in. As a result, there is essentially no quantization error or nonmonotonic behavior, and temperature hysteresis is very low (typically less than $2 mg$ over the $-40^\circ C$ to $+175^\circ C$ temperature range).

Figure 12 shows the $0 g$ output performance of eight parts over the $-40^\circ C$ to $+175^\circ C$ temperature range.

Figure 11 and Figure 14 show the typical sensitivity shift over temperature for $V_s = 5 V$. Sensitivity stability is optimized for $V_s = 5 V$, but it is very good over the full supply voltage range.

APPLICATIONS INFORMATION

POWER SUPPLY DECOUPLING

For most applications, a single 0.1 μF capacitor, C_{DC} , adequately decouples the accelerometer from noise on the power supply. In some cases, however, particularly where noise is present at the 140 kHz internal clock frequency (or any harmonic thereof), noise on the supply can cause interference on the ADXL206 output. If additional decoupling is needed, a 100 Ω (or smaller) resistor or ferrite bead can be inserted in the supply line of the ADXL206. Additionally, a larger bulk bypass capacitor (in the 1 μF to 22 μF range) can be added in parallel to C_{DC} .

SETTING THE BANDWIDTH USING C_X AND C_Y

The ADXL206 has provisions for band-limiting the X_{OUT} and Y_{OUT} pins. A capacitor must be added to the pin to implement low-pass filtering for antialiasing and noise reduction. The equation for the 3 dB bandwidth is

$$f_{-3\text{ dB}} = 1/(2\pi(32\text{ k}\Omega) \times C_x)$$

or more simply,

$$f_{-3\text{ dB}} = 5\ \mu\text{F}/C_x$$

The tolerance of the internal resistor (R_{FILT}) can vary typically as much as $\pm 25\%$ of its nominal value (32 k Ω); thus, the bandwidth varies accordingly. A minimum capacitance of 2000 pF for C_X and C_Y is required in all cases.

Table 6. Filter Capacitor Selection, C_X and C_Y

Bandwidth (Hz)	Capacitor (μF)
1	4.7
10	0.47
50	0.10
100	0.05
200	0.027
500	0.01

SELF-TEST

The ST pin controls the self-test feature. When this pin is set to V_S , an electrostatic force is exerted on the beam of the accelerometer. The resulting movement of the beam allows the user to test whether the accelerometer is functional. The typical change in output is 800 mg (corresponding to 250 mV). This pin can be left open-circuit or connected to common in normal use.

The ST pin should never be exposed to voltage greater than $V_S + 0.3\text{ V}$. If the system design is such that this condition cannot be guaranteed (that is, multiple supply voltages are present), it is recommended that a clamping diode with low forward voltage be connected between ST and V_S .

DESIGN TRADE-OFFS FOR SELECTING FILTER

CHARACTERISTICS: NOISE/BANDWIDTH TRADE-OFF

The accelerometer bandwidth selected ultimately determines the measurement resolution (smallest detectable acceleration). Filtering can be used to lower the noise floor, improving the resolution of the accelerometer. Resolution is dependent on the analog filter bandwidth at X_{OUT} .

The output of the ADXL206 has a typical bandwidth of 2.5 kHz. The user must filter the signal at this point to limit aliasing errors. The analog bandwidth must be no more than half the analog-to-digital sampling frequency to minimize aliasing. The analog bandwidth can be further decreased to reduce noise and improve resolution.

The ADXL206 noise has the characteristics of white Gaussian noise, which contributes equally at all frequencies and is described in terms of $\mu\text{g}/\sqrt{\text{Hz}}$ (that is, the noise is proportional to the square root of the accelerometer bandwidth). The user should limit bandwidth to the lowest frequency needed by the application to maximize the resolution and dynamic range of the accelerometer.

With the single-pole roll-off characteristic, the typical noise of the ADXL206 is determined by

$$\text{rms Noise} = (110\ \mu\text{g}/\sqrt{\text{Hz}}) \times (\sqrt{BW} \times 1.6)$$

At 100 Hz, the noise is

$$\text{rms Noise} = (110\ \mu\text{g}/\sqrt{\text{Hz}}) \times (\sqrt{100} \times 1.6) = 1.4\ \text{mg}$$

Often, the peak value of the noise is desired. Peak-to-peak noise can only be estimated by statistical methods. Table 7 is useful for estimating the probability of exceeding various peak values, given the rms value.

Table 7. Estimation of Peak-to-Peak Noise

Peak-to-Peak Value	% of Time That Noise Exceeds Nominal Peak-to-Peak Value
2 \times rms	32
4 \times rms	4.6
6 \times rms	0.27
8 \times rms	0.006

Peak-to-peak noise values give the best estimate of the uncertainty in a single measurement; peak-to-peak noise is estimated by 6 \times rms. Table 8 gives the typical noise output of the ADXL206 for various C_X and C_Y values.

Table 8. Typical Noise Output for Various Capacitor Values

Bandwidth (Hz)	C_X, C_Y (μF)	RMS Noise (mg)	Peak-to-Peak Noise Estimate (mg)
10	0.47	0.4	2.6
50	0.1	1.0	6
100	0.047	1.4	8.4
500	0.01	3.1	18.7

USING THE ADXL206 WITH OPERATING VOLTAGES OTHER THAN 5 V

The ADXL206 is tested and specified at $V_s = 5$ V; however, it can be powered with V_s as low as 3 V or as high as 6 V. Some performance parameters change as the supply voltage is varied.

The ADXL206 output is ratiometric; therefore, the output sensitivity (or scale factor) varies proportionally to the supply voltage. The zero g bias output is also ratiometric; therefore, the zero g output is nominally equal to $V_s/2$ at all supply voltages.

The output noise is not ratiometric but is absolute in volts; therefore, the noise density decreases as the supply voltage increases.

Self-test response in g is roughly proportional to the square of the supply voltage. However, when ratiometricity of sensitivity is factored in with supply voltage, self-test response in volts is roughly proportional to the cube of the supply voltage. Therefore, at $V_s = 3$ V, the typical self-test response is approximately 50 mV or about 160 mg.

USING THE ADXL206 AS A DUAL-AXIS TILT SENSOR

One of the most popular applications of the ADXL206 is tilt measurement. An accelerometer uses the force of gravity as an input vector to determine the orientation of an object in space.

An accelerometer is most sensitive to tilt when its sensitive axis is perpendicular to the force of gravity, that is, parallel to the earth's surface. At this orientation, the sensitivity of the accelerometer to changes in tilt is highest. When the axis of sensitivity is parallel to gravity, that is, near its $+1 g$ or $-1 g$ reading, the change in output acceleration per degree of tilt is negligible. When the accelerometer is perpendicular to gravity, its output changes nearly 17.5 mg per degree of tilt. At 45° , its output changes at only 12.2 mg per degree and resolution declines.

Dual-Axis Tilt Sensor: Converting Acceleration to Tilt

When the accelerometer is oriented so that both its x-axis and y-axis are parallel to the earth's surface, it can be used as a 2-axis tilt sensor with a roll axis and a pitch axis. After the output signal from the accelerometer is converted to an acceleration that varies between $-1 g$ and $+1 g$, the output tilt in degrees is calculated as follows:

$$PITCH = \arcsin(A_x/1 g)$$

$$ROLL = \arcsin(A_y/1 g)$$

Make sure to account for overranges. It is possible for the accelerometer to output a signal greater than $\pm 1 g$ due to vibration, shock, or other accelerations.

ADXL206

OUTLINE DIMENSIONS

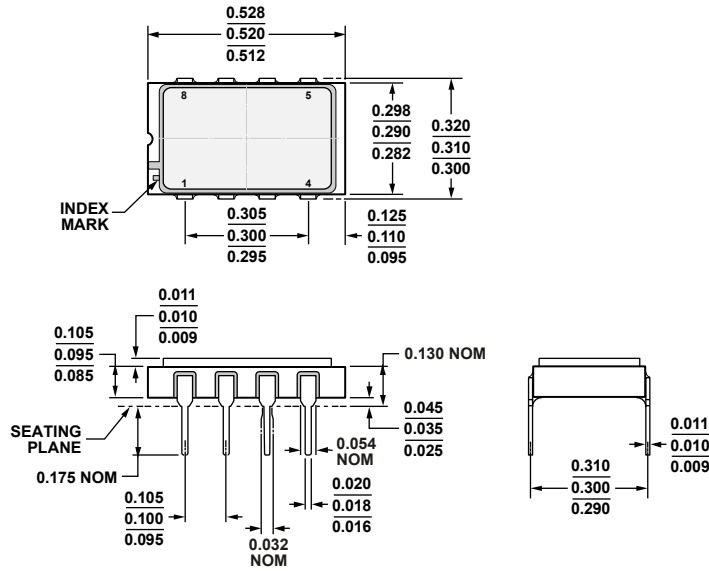

Figure 20. 8-Lead Side-Brazed Ceramic Dual In-Line Package [SBDIP]
(D-8-1)
Dimensions shown in inches

ORDERING GUIDE

Model ^{1, 2}	Number of Axes	Specified Voltage (V)	Temperature Range	Package Description	Package Option
ADXL206HDZ	2	5	-40°C to +175°C	8-Lead SBDIP	D-8-1

¹ Lead finish. Gold over nickel over tungsten.

² Z = RoHS Compliant Part.



Компания «ЭлектроПласт» предлагает заключение долгосрочных отношений при поставках импортных электронных компонентов на взаимовыгодных условиях!

Наши преимущества:

- Оперативные поставки широкого спектра электронных компонентов отечественного и импортного производства напрямую от производителей и с крупнейших мировых складов;
- Поставка более 17-ти миллионов наименований электронных компонентов;
- Поставка сложных, дефицитных, либо снятых с производства позиций;
- Оперативные сроки поставки под заказ (от 5 рабочих дней);
- Экспресс доставка в любую точку России;
- Техническая поддержка проекта, помощь в подборе аналогов, поставка прототипов;
- Система менеджмента качества сертифицирована по Международному стандарту ISO 9001;
- Лицензия ФСБ на осуществление работ с использованием сведений, составляющих государственную тайну;
- Поставка специализированных компонентов (Xilinx, Altera, Analog Devices, Intersil, Interpoint, Microsemi, Aeroflex, Peregrine, Syfer, Eurofarad, Texas Instrument, Miteq, Cobham, E2V, MA-COM, Hittite, Mini-Circuits, General Dynamics и др.);

Помимо этого, одним из направлений компании «ЭлектроПласт» является направление «Источники питания». Мы предлагаем Вам помощь Конструкторского отдела:

- Подбор оптимального решения, техническое обоснование при выборе компонента;
- Подбор аналогов;
- Консультации по применению компонента;
- Поставка образцов и прототипов;
- Техническая поддержка проекта;
- Защита от снятия компонента с производства.



Как с нами связаться

Телефон: 8 (812) 309 58 32 (многоканальный)

Факс: 8 (812) 320-02-42

Электронная почта: org@eplast1.ru

Адрес: 198099, г. Санкт-Петербург, ул. Калинина, дом 2, корпус 4, литера А.