

FEATURES

Ultralow power operation

3.3 V operation (typical)

5.6 μA per channel quiescent current, refresh enabled

0.3 μA per channel quiescent current, refresh disabled

148 $\mu\text{A}/\text{Mbps}$ per channel typical dynamic current

2.5 V operation (typical)

3.1 μA per channel quiescent current, refresh enabled

0.1 μA per channel quiescent current, refresh disabled

117 $\mu\text{A}/\text{Mbps}$ per channel typical dynamic current

Small, 16-lead QSOP and 20-Lead SSOP

Bidirectional communication

Up to 2 Mbps data rate (NRZ)

High temperature operation: 125°C

High common-mode transient immunity: >25 kV/ μs

Safety and regulatory approvals

UL 1577 component recognition program

2500 V rms for 1 minute per UL 1577 QSOP package

3750V rms for 1 minute per UL 1577 SSOP package

CSA Component Acceptance Notice 5A

VDE certificate of conformity

DIN V VDE V 0884-10 (VDE V 0884-10):2006-12

$V_{\text{IORM}} = 565 V_{\text{PEAK}}$ QSOP package

$V_{\text{IORM}} = 849 V_{\text{PEAK}}$ SSOP package

IECEX and ATEX intrinsic safety

Sira 0518 II 1G Ex ia IIC Ga

APPLICATIONS

General-purpose, low power multichannel isolation

1 MHz, low power peripheral interface (SPI)

4 mA to 20 mA loop process controls

GENERAL DESCRIPTION

The [ADuM1440/ADuM1441/ADuM1442/ADuM1445/ADuM1446/ADuM1447](#)¹ are micropower, 4-channel digital isolators based on the Analog Devices, Inc., *iCoupler*® technology. Combining high speed, complementary metal oxide semiconductor (CMOS) and monolithic air core transformer technologies, these isolation components provide outstanding performance characteristics superior to the alternatives, such as optocoupler devices. As shown in Figure 3, in standard operating mode, when $\text{EN}_x = 0$ (internal refresh enabled), the current per channel is less than 10 μA . When $\text{EN}_x = 1$ (internal refresh disabled), the current per channel drops to less than 1 μA .

The [ADuM1440/ADuM1441/ADuM1442/ADuM1445/ADuM1446/ADuM1447](#) family of quad 2.5 kV digital isolation devices are packaged in a small 16-lead QSOP and 20-lead SSOP,

¹ Protected by U.S. Patents 5,952,849, 6,873,065, 7,075,329, 6,262,600. Other patents pending.

Rev. E

[Document Feedback](#)

Information furnished by Analog Devices is believed to be accurate and reliable. However, no responsibility is assumed by Analog Devices for its use, nor for any infringements of patents or other rights of third parties that may result from its use. Specifications subject to change without notice. No license is granted by implication or otherwise under any patent or patent rights of Analog Devices. Trademarks and registered trademarks are the property of their respective owners.

FUNCTIONAL BLOCK DIAGRAMS

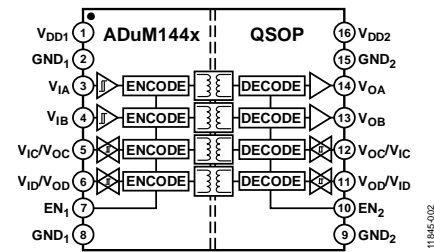

Figure 1.

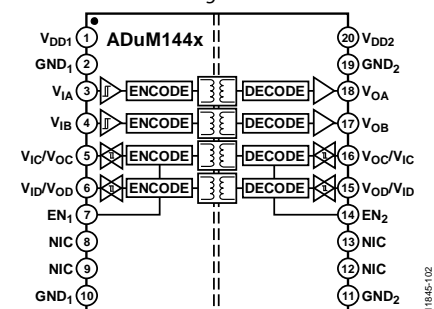

Figure 2.

freeing almost 70% of board space compared to isolators packages in wide body SOIC packages.

The devices withstand high isolation voltages and meet regulatory requirements, such as UL and CSA standards. In addition to the space savings, the [ADuM1440/ADuM1441/ADuM1442/ADuM1445/ADuM1446/ADuM1447](#) operate with supplies as low as 2.25 V.

Despite the low power consumption, all models of the [ADuM1440/ADuM1441/ADuM1442/ADuM1445/ADuM1446/ADuM1447](#) provide low, pulse width distortion at <8 ns. In addition, every model has an input glitch filter to protect against extraneous noise disturbances.



Figure 3. Typical Total Supply Current per Channel ($V_{\text{DDX}} = 3.3 \text{ V}$)

TABLE OF CONTENTS

Features	1	Intrinsic Safety	11
Applications	1	Absolute Maximum Ratings	13
General Description	1	ESD Caution	13
Functional Block Diagrams	1	Pin Configurations and Function Descriptions	14
Revision History	2	Typical Performance Characteristics	17
Specifications	3	Applications Information	20
Electrical Characteristics—3.3 V Operation	3	PCB Layout	20
Electrical Characteristics—2.5 V Operation	5	Propagation Delay-Related Parameters	20
Electrical Characteristics— $V_{DD1} = 3.3\text{ V}$, $V_{DD2} = 2.5\text{ V}$ Operation	7	DC Correctness	20
Electrical Characteristics— $V_{DD1} = 2.5\text{ V}$, $V_{DD2} = 3.3\text{ V}$ Operation	8	Magnetic Field Immunity	21
Package Characteristics	9	Power Consumption	22
Regulatory Information	9	Insulation Lifetime	22
Insulation and Safety Related Specifications	10	Outline Dimensions	24
DIN V VDE V 0884-10 (VDE V 0884-10):2006-12 Insulation Characteristics	10	Ordering Guide	25

REVISION HISTORY

1/2017—Rev. D to Rev. E

Changes to Features Section	1
Changes to Table 12	9
Added Intrinsic Safety Section, Table 16; Renumbered Sequentially, and Table 17	11

4/2015—Rev. C to Rev. D

Change to General Description Section	1
---	---

4/2015—Rev. B to Rev. C

Changes to Regulatory Information Section	9
---	---

3/2015—Rev. A to Rev. B

Changes to Features Section and Figure 3	1
Changes to Table 12	9
Changes to Table 13 and Table 14	10
Updated Outline Dimensions	23
Changes to Ordering Guide	24

3/2014—Rev. 0 to Rev. A

Added SSOP Package	Universal
Changes to Features Section, Added Figure 2, Renumbered Sequentially	1
Changes to Output Voltage Logic High Parameter, Table 3	4
Added Table 15, Renumbered Sequentially; Changes to Figure 4	11
Change to Supply Voltages (V_{DD1} , V_{DD2}) Parameter, Table 17	12
Added Figure 6; Changes to Table 20	13
Added Figure 8; Changes to Table 21	14
Added Figure 10, Changes to Table 22	15
Added Figure 30	19
Changes to Power Consumption Section; Added Table 23	21
Added Figure 27	23
Changes to Ordering Guide	24

10/2013—Revision 0: Initial Version

SPECIFICATIONS

ELECTRICAL CHARACTERISTICS—3.3 V OPERATION

All typical specifications are at $T_A = 25^\circ\text{C}$, $V_{DD1} = V_{DD2} = 3.3\text{ V}$. Minimum/maximum specifications apply over the entire recommended operating range of $3.0\text{ V} \leq V_{DD1} \leq 3.6\text{ V}$, $3.0\text{ V} \leq V_{DD2} \leq 3.6\text{ V}$, and $-40^\circ\text{C} \leq T_A \leq +125^\circ\text{C}$, unless otherwise noted. Switching specifications are tested with $C_L = 15\text{ pF}$, and CMOS signal levels, unless otherwise noted.

Table 1.

Parameter	Symbol	Min	Typ	Max	Unit	Test Conditions/Comments
SWITCHING SPECIFICATIONS						
Data Rate				2	Mbps	Within pulse-width distortion (PWD) limit
Propagation Delay	t_{PHL} , t_{PLH}		80	180	ns	50% input to 50% output
Change vs. Temperature			200		ps/ $^\circ\text{C}$	
Minimum Pulse Width	PW	500			ns	Within PWD limit
Pulse-Width Distortion	PWD			8	ns	$ t_{PLH} - t_{PHL} $
Propagation Delay Skew ¹	t_{PSK}			10	ns	
Channel Matching						
Codirectional	t_{PSKCD}			10	ns	
Opposing Direction	t_{PSKOD}			15	ns	

¹ t_{PSK} is the magnitude of the worst-case difference in t_{PHL} and t_{PLH} that is measured between units at the same operating temperature, supply voltages, and output load within the recommended operating conditions.

Table 2.

Parameter	Symbol	Min	Typ	Max	Unit	Test Conditions/Comments
SUPPLY CURRENT						
ADuM1440/ADuM1445	I_{DD1}		732	1000	μA	2 Mbps, no load $EN_X = 0\text{ V}$, $V_{IH} = V_{DD}$, $V_{IL} = 0\text{ V}$
	I_{DD2}		492	750	μA	$EN_X = 0\text{ V}$, $V_{IH} = V_{DD}$, $V_{IL} = 0\text{ V}$
ADuM1441/ADuM1446	I_{DD1}		672	900	μA	$EN_X = 0\text{ V}$, $V_{IH} = V_{DD}$, $V_{IL} = 0\text{ V}$
	I_{DD2}		552	900	μA	$EN_X = 0\text{ V}$, $V_{IH} = V_{DD}$, $V_{IL} = 0\text{ V}$
ADuM1442/ADuM1447	I_{DD1}		612	900	μA	$EN_X = 0\text{ V}$, $V_{IH} = V_{DD}$, $V_{IL} = 0\text{ V}$
	I_{DD2}		612	900	μA	$EN_X = 0\text{ V}$, $V_{IH} = V_{DD}$, $V_{IL} = 0\text{ V}$

Table 3. For All Models

Parameter	Symbol	Min	Typ	Max	Unit	Test Conditions/Comments
DC SPECIFICATIONS						
Input Threshold						
Logic High	V_{IH}	$0.7 V_{DDx}^1$			V	
Logic Low	V_{IL}			$0.3 V_{DDx}^1$	V	
Output Voltages						
Logic High	V_{OH}	$V_{DDx}^1 - 0.1$ $V_{DDx}^1 - 0.4$	3.3 3.1		V V	$I_{OUTx} = -20 \mu A, V_{IX} = V_{IXH}$ $I_{OUTx} = -4 mA, V_{IX} = V_{IXH}$
Logic Low	V_{OL}		0.0 0.2	0.1 0.4	V V	$I_{OUTx} = 20 \mu A, V_{IX} = V_{IXL}$ $I_{OUTx} = 4 mA, V_{IX} = V_{IXL}$
Input Current per Channel	I_I	-1	+0.01	+1	μA	$0V \leq V_{IX} \leq V_{DDx}^1$
Input Switching Thresholds						
Positive Threshold Voltage	V_{T+}		1.8		V	
Negative Going Threshold	V_{T-}		1.2		V	
Input Hysteresis	ΔV_T		0.6		V	
Undervoltage Lockout, V_{DD1} or V_{DD2}	UVLO		1.5		V	
Supply Current per Channel						
Quiescent Current						
Input Supply	$I_{DDI(Q)}$		4.8	10	μA	ENx low
Output Supply	$I_{DDO(Q)}$		0.8	3.3	μA	ENx low
Input (Refresh Off)	$I_{DDI(Q)}$		0.12		μA	ENx high
Output (Refresh Off)	$I_{DDO(Q)}$		0.13		μA	ENx high
Dynamic Supply Current						
Input	$I_{DDI(D)}$		88		$\mu A/Mbps$	
Output	$I_{DDO(D)}$		60		$\mu A/Mbps$	
AC SPECIFICATIONS						
Output Rise Time/Fall Time	t_R/t_F		2		ns	10% to 90%
Common-Mode Transient Immunity ²	$ CM $	25	40		kV/ μs	$V_{IX} = V_{DDx}^1, V_{CM} = 1000 V,$ transient magnitude = 800 V
Refresh Rate	f_r		14		kbps	

¹ $V_{DDx} = V_{DD1}$ or V_{DD2} .² $|CM|$ is the maximum common-mode voltage slew rate that can be sustained while maintaining $V_{OUT} > 0.8 V_{DDx}$. The common-mode voltage slew rates apply to both rising and falling common-mode voltage edges.

ELECTRICAL CHARACTERISTICS—2.5 V OPERATION

All typical specifications are at $T_A = 25^\circ\text{C}$, $V_{DD1} = V_{DD2} = 2.5\text{ V}$. Minimum/maximum specifications apply over the entire recommended operating range of $2.25\text{ V} \leq V_{DD1} \leq 2.75\text{ V}$, $2.25\text{ V} \leq V_{DD2} \leq 2.75\text{ V}$, and $-40^\circ\text{C} \leq T_A \leq +125^\circ\text{C}$, unless otherwise noted. Switching specifications are tested with $C_L = 15\text{ pF}$, and CMOS signal levels, unless otherwise noted.

Table 4.

Parameter	Symbol	Min	Typ	Max	Unit	Test Conditions/Comments
SWITCHING SPECIFICATIONS						
Data Rate				2	Mbps	Within PWD limit
Propagation Delay	t_{PHL}, t_{PLH}		112	180	ns	50% input to 50% output
Change vs. Temperature			280		ps/°C	
Pulse-Width Distortion	PWD			12	ns	$ t_{PLH} - t_{PHL} $
Minimum Pulse Width	PW	500			ns	Within PWD limit
Propagation Delay Skew ¹	t_{PSK}			10	ns	
Channel Matching						
Codirectional	t_{PSKCD}			10	ns	
Opposing Direction	t_{PSKOD}			30	ns	

¹ t_{PSK} is the magnitude of the worst-case difference in t_{PHL} or t_{PLH} that is measured between units at the same operating temperature, supply voltages, and output load within the recommended operating conditions.

Table 5.

Parameter	Symbol	Min	Typ	Max	Unit	Test Conditions/Comments
SUPPLY CURRENT						
ADuM1440/ADuM1445	I_{DD1}		623	800	μA	2 Mbps, no load $EN_x = 0\text{ V}, V_{IH} = V_{DD}, V_{IL} = 0\text{ V}$
	I_{DD2}		337	500	μA	$EN_x = 0\text{ V}, V_{IH} = V_{DD}, V_{IL} = 0\text{ V}$
ADuM1441/ADuM1446	I_{DD1}		552	750	μA	$EN_x = 0\text{ V}, V_{IH} = V_{DD}, V_{IL} = 0\text{ V}$
	I_{DD2}		409	750	μA	$EN_x = 0\text{ V}, V_{IH} = V_{DD}, V_{IL} = 0\text{ V}$
ADuM1442/ADuM1447	I_{DD1}		480	750	μA	$EN_x = 0\text{ V}, V_{IH} = V_{DD}, V_{IL} = 0\text{ V}$
	I_{DD2}		480	750	μA	$EN_x = 0\text{ V}, V_{IH} = V_{DD}, V_{IL} = 0\text{ V}$

Table 6. For All Models

Parameter	Symbol	Min	Typ	Max	Unit	Test Conditions/Comments
DC SPECIFICATIONS						
Input Threshold						
Logic High	V_{IH}	$0.7 V_{DDx}^1$			V	
Logic Low	V_{IL}			$0.3 V_{DDx}^1$	V	
Output Voltages						
Logic High	V_{OH}	$V_{DDx}^1 - 0.1$ $V_{DDx}^1 - 0.4$	2.5 2.35		V V	$I_{Ox} = -20 \mu A, V_{Ix} = V_{IxH}$ $I_{Ox} = -4 mA, V_{Ix} = V_{IxH}$
Logic Low	V_{OL}		0.0 0.1	0.1 0.4	V V	$I_{Ox} = 20 \mu A, V_{Ix} = V_{IxL}$ $I_{Ox} = 4 mA, V_{Ix} = V_{IxL}$
Input Current per Channel	I_I	-1	+0.01	+1	μA	$0V \leq V_{Ix} \leq V_{DDx}^1$
Input Switching Thresholds						
Positive Threshold Voltage	V_{T+}		1.5		V	
Negative Going Threshold	V_{T-}		1.0		V	
Input Hysteresis	ΔV_T		0.5		V	
Undervoltage Lockout, V_{DD1} or V_{DD2}	UVLO		1.5		V	
Supply Current per Channel						
Quiescent Current						
Input Supply	$I_{DDI(Q)}$		2.6	3.3	μA	EN _x low
Output Supply	$I_{DDO(Q)}$		0.5	1.8	μA	EN _x low
Input (Refresh Off)	$I_{DDI(Q)}$		0.05		μA	EN _x high
Output (Refresh Off)	$I_{DDO(Q)}$		0.05		μA	EN _x high
Dynamic Supply Current						
Input	$I_{DDI(D)}$		76		$\mu A/Mbps$	
Output	$I_{DDO(D)}$		41		$\mu A/Mbps$	
AC SPECIFICATIONS						
Output Rise Time/Fall Time	t_R/t_F		2		ns	10% to 90%
Common-Mode Transient Immunity ²	$ CM $	25	40		kV/ μs	$V_{Ix} = V_{DDx}^1, V_{CM} = 1000 V,$ transient magnitude = 800 V
Refresh Rate	f_r		14		kbps	

¹ $V_{DDx} = V_{DD1}$ or V_{DD2} .² $|CM|$ is the maximum common-mode voltage slew rate that can be sustained while maintaining $V_{OUT} > 0.8 V_{DDx}$. The common-mode voltage slew rates apply to both rising and falling common-mode voltage edges.

ELECTRICAL CHARACTERISTICS— $V_{DD1} = 3.3\text{ V}$, $V_{DD2} = 2.5\text{ V}$ OPERATION

All typical specifications are at $T_A = 25^\circ\text{C}$, $V_{DD1} = 3.3\text{ V}$, and $V_{DD2} = 2.5\text{ V}$. Minimum/maximum specifications apply over the entire recommended operating range of $3.0\text{ V} \leq V_{DD1} \leq 3.6\text{ V}$, $2.25\text{ V} \leq V_{DD2} \leq 2.75\text{ V}$, and $-40^\circ\text{C} \leq T_A \leq +125^\circ\text{C}$, unless otherwise noted. Switching specifications are tested with $C_L = 15\text{ pF}$, and CMOS signal levels, unless otherwise noted.

For dc specifications and ac specifications, see Table 3 for Side 1 and see Table 6 for Side 2.

Table 7.

Parameter	Symbol	Min	Typ	Max	Unit	Test Conditions/Comments
SWITCHING SPECIFICATIONS						
Data Rate				2	Mbps	Within PWD limit
Propagation Delay						
Side 1 to Side 2	t_{PHL}, t_{PLH}		84	180	ns	50% input to 50% output
Side 2 to Side 1	t_{PHL}, t_{PLH}		120	180	ns	50% input to 50% output
Change vs. Temperature			280		ps/ $^\circ\text{C}$	
Pulse-Width Distortion	PWD			12	ns	$ t_{PLH} - t_{PHL} $
Pulse Width	PW	500			ns	Within PWD limit
Propagation Delay Skew ¹	t_{PSK}			10	ns	
Channel Matching						
Codirectional	t_{PSKCD}			10	ns	
Opposing Direction	t_{PSKOD}			60	ns	

¹ t_{PSK} is the magnitude of the worst-case difference in t_{PHL} or t_{PLH} that is measured between units at the same operating temperature, supply voltages, and output load within the recommended operating conditions.

Table 8.

Parameter	Symbol	Min	Typ	Max	Unit	Test Conditions/Comments
SUPPLY CURRENT						
						2 Mbps, no load
ADuM1440/ADuM1445	I_{DD1}		732	1000	μA	$E_{N_x} = 0\text{ V}$, $V_{IH} = V_{DD}$, $V_{IL} = 0\text{ V}$
	I_{DD2}		337	750	μA	$E_{N_x} = 0\text{ V}$, $V_{IH} = V_{DD}$, $V_{IL} = 0\text{ V}$
ADuM1441/ADuM1446	I_{DD1}		672	900	μA	$E_{N_x} = 0\text{ V}$, $V_{IH} = V_{DD}$, $V_{IL} = 0\text{ V}$
	I_{DD2}		409	750	μA	$E_{N_x} = 0\text{ V}$, $V_{IH} = V_{DD}$, $V_{IL} = 0\text{ V}$
ADuM1442/ADuM1447	I_{DD1}		612	900	μA	$E_{N_x} = 0\text{ V}$, $V_{IH} = V_{DD}$, $V_{IL} = 0\text{ V}$
	I_{DD2}		480	750	μA	$E_{N_x} = 0\text{ V}$, $V_{IH} = V_{DD}$, $V_{IL} = 0\text{ V}$

ELECTRICAL CHARACTERISTICS— $V_{DD1} = 2.5\text{ V}$, $V_{DD2} = 3.3\text{ V}$ OPERATION

All typical specifications are at $T_A = 25^\circ\text{C}$, $V_{DD1} = 2.5$, and $V_{DD2} = 3.3\text{ V}$. Minimum/maximum specifications apply over the entire recommended operating range of $2.25\text{ V} \leq V_{DD1} \leq 2.75\text{ V}$, $3.0\text{ V} \leq V_{DD2} \leq 3.6\text{ V}$, and $-40^\circ\text{C} \leq T_A \leq +125^\circ\text{C}$, unless otherwise noted. Switching specifications are tested with $C_L = 15\text{ pF}$, and CMOS signal levels, unless otherwise noted.

For dc specifications and ac specifications, see Table 6 for Side 1 and see Table 3 for Side 2.

Table 9.

Parameter	Symbol	Min	Typ	Max	Unit	Test Conditions/Comments
SWITCHING SPECIFICATIONS						
Data Rate				2	Mbps	Within PWD limit
Propagation Delay						
Side 1 to Side 2	t_{PHL}, t_{PLH}		120	180	ns	50% input to 50% output
Side 2 to Side 1	t_{PHL}, t_{PLH}		84	180	ns	50% input to 50% output
Change vs. Temperature			200		ps/ $^\circ\text{C}$	
Pulse-Width Distortion	PWD			12	ns	$ t_{PLH} - t_{PHL} $
Pulse Width	PW	500			ns	Within PWD limit
Propagation Delay Skew ¹	t_{PSK}			10	ns	
Channel Matching						
Codirectional	t_{PSKCD}			10	ns	
Opposing Direction	t_{PSKOD}			60	ns	

¹ t_{PSK} is the magnitude of the worst-case difference in t_{PHL} or t_{PLH} that is measured between units at the same operating temperature, supply voltages, and output load within the recommended operating conditions.

Table 10.

Parameter	Symbol	Min	Typ	Max	Unit	Test Conditions/Comments
SUPPLY CURRENT						
						2 Mbps, no load
ADuM1440/ADuM1445	I_{DD1}		623	1000	μA	$EN_x = 0\text{ V}$, $V_{IH} = V_{DD}$, $V_{IL} = 0\text{ V}$
	I_{DD2}		492	750	μA	$EN_x = 0\text{ V}$, $V_{IH} = V_{DD}$, $V_{IL} = 0\text{ V}$
ADuM1441/ADuM1446	I_{DD1}		552	750	μA	$EN_x = 0\text{ V}$, $V_{IH} = V_{DD}$, $V_{IL} = 0\text{ V}$
	I_{DD2}		552	900	μA	$EN_x = 0\text{ V}$, $V_{IH} = V_{DD}$, $V_{IL} = 0\text{ V}$
ADuM1442/ADuM1447	I_{DD1}		480	750	μA	$EN_x = 0\text{ V}$, $V_{IH} = V_{DD}$, $V_{IL} = 0\text{ V}$
	I_{DD2}		612	900	μA	$EN_x = 0\text{ V}$, $V_{IH} = V_{DD}$, $V_{IL} = 0\text{ V}$

PACKAGE CHARACTERISTICS

Table 11.

Parameter	Symbol	Min	Typ	Max	Unit	Test Conditions/Comments
Resistance (Input-to-Output) ¹	R _{I-O}		10 ¹³		Ω	
Capacitance (Input-to-Output) ¹	C _{I-O}		2		pF	f = 1 MHz
Input Capacitance ²	C _I		4.0		pF	
IC Junction-to-Ambient Thermal Resistance (QSOP)	θ _{JA}		76		°C/W	Thermocouple located at center of package underside
IC Junction-to-Ambient Thermal Resistance (SSOP)	θ _{JA}		50.5		°C/W	Thermocouple located at center of package underside

¹ The device is considered a 2-terminal device: Pin 1 through Pin 8 are shorted together, and Pin 9 through Pin 16 are shorted together.

² Input capacitance is from any input data pin to ground.

REGULATORY INFORMATION

See Table 20 and the Insulation Lifetime section for the recommended maximum working voltages for specific cross-isolation waveforms and insulation levels.

Table 12. Safety Certifications

UL	CSA	VDE	CSA/Sira
Recognized Under UL 1577 Component Recognition Program ¹ Single Protection	Approved under CSA Component Acceptance Notice 5A CSA 60950-1-07+A1+A2 and IEC 60950-1 second edition +A1+A2	Certified according to DIN V VDE V 0884-10 (VDE V 0884-10):2006-12 ² QSOP package: reinforced insulation, 565 V _{PEAK} QSOP package	Certified for use in intrinsic safety (IS) to IS applications under ATEX and IECEx ATEX: EN 60079-0:2012+A11:2013 and EN 60079-11:2012
2500 V RMS Isolation Voltage (RQ-16 Only)	QSOP package: basic insulation, 310 V rms maximum working voltage	SSOP package: reinforced insulation, 849 V _{PEAK} SSOP package	IECEx: IEC 60079-0:2011 Edition 6 and IEC 60079-11:2011 Edition 6
3750 V RMS Isolation Voltage (RS-20 Only)	SSOP package: basic insulation at 510 V rms (721 V _{PEAK}) maximum working voltage and IEC 60601-1 Edition 3.1 250 V (1 means of patient protection (MOPP)); reinforced insulation at 255 V rms (360 V _{PEAK}) maximum working voltage		II 1G Ex ia IIC Ga
File E214100	File 205078	File 2471900-4880-0001	File 70013932

¹ In accordance with UL 1577, each ADuM1440/ADuM1441/ADuM1442/ADuM1445/ADuM1446/ADuM1447 is proof tested by applying an insulation test voltage and measuring leakage during final production testing. QSOP package devices are tested at ≥3000 V rms for 1 sec with a current leakage detection limit = 5 μA. SSOP package devices are tested at ≥4500 V rms for 1 sec with a current leakage detection limit = 10 μA.

² In accordance with DIN V VDE V 0884-10, each ADuM1440/ADuM1441/ADuM1442/ADuM1445/ADuM1446/ADuM1447 is proof tested by applying an insulation test voltage ≥1059 V_{PEAK} for 1 second (partial discharge detection limit = 5 pC). The asterisk (*) marked on the component designates DIN V VDE V 0884-10 approval.

INSULATION AND SAFETY RELATED SPECIFICATIONS

Table 13.

Parameter	Symbol	Value	Unit	Test Conditions/Comments
Rated Dielectric Insulation Voltage (RQ-16)		2500	V rms	1-minute duration
Rated Dielectric Insulation Voltage (RS-20)		3750	V rms	1-minute duration
Minimum External Tracking and Air Gap, RQ-16 (Creepage and Clearance)	L(I02)	3.1	mm min	Measured from input terminals to output terminals, shortest distance path along package body
Minimum Clearance in the Plane of the Printed Circuit Board, RQ-16 (PCB Clearance)	L(I01)	3.8	mm min	Measured from input terminals to output terminals, shortest distance through air, line of sight, in the PCB mounting plane
Minimum External Tracking and Air Gap, RS-20 (Creepage and Clearance)	L(I01)	5.1	mm min	Measured from input terminals to output terminals, shortest distance path along package body
Minimum Clearance in the Plane of the Printed Circuit Board, RS-20 (PCB Clearance)	L(I02)	5.1	mm min	Measured from input terminals to output terminals, shortest distance through air, line of sight, in the PCB mounting plane
Minimum Internal Gap (Internal Clearance)		0.017	mm min	Insulation distance through insulation
Tracking Resistance (Comparative Tracking Index)	CTI	>400	V	DIN IEC 112/VDE 0303 Part 1
Isolation Group		II		Material Group (DIN VDE 0110, 1/89, Table 1)

DIN V VDE V 0884-10 (VDE V 0884-10):2006-12 INSULATION CHARACTERISTICS

These isolators are suitable for reinforced electrical isolation within the safety limit data only. Maintenance of the safety data is ensured by protective circuits. The asterisk (*) marked on packages denotes DIN V VDE V 0884-10 approval.

Table 14. 16-Lead QSOP (RQ-16)

Description	Test Conditions/Comments	Symbol	Characteristic	Unit
Installation Classification per DIN VDE 0110 For Rated Mains Voltage ≤ 150 V rms For Rated Mains Voltage ≤ 300 V rms For Rated Mains Voltage ≤ 400 V rms			I to IV I to III I to II	
Climatic Classification			40/105/21	
Pollution Degree per DIN VDE 0110, Table 1			2	
Maximum Working Insulation Voltage		V_{IORM}	565	V_{PEAK}
Input-to-Output Test Voltage, Method b1	$V_{IORM} \times 1.875 = V_{pd(m)}$, 100% production test, $t_{ini} = t_m = 1$ sec, partial discharge < 5 pC	$V_{pd(m)}$	1059	V_{PEAK}
Input-to-Output Test Voltage, Method a After Environmental Tests Subgroup 1	$V_{IORM} \times 1.5 = V_{pd(m)}$, $t_{ini} = 60$ sec, $t_m = 10$ sec, partial discharge < 5 pC	$V_{pd(m)}$	847	V_{PEAK}
After Input and/or Safety Test Subgroup 2 and Subgroup 3	$V_{IORM} \times 1.2 = V_{pd(m)}$, $t_{ini} = 60$ sec, $t_m = 10$ sec, partial discharge < 5 pC	$V_{pd(m)}$	678	V_{PEAK}
Highest Allowable Overvoltage		V_{IOTM}	4000	V_{PEAK}
Surge Isolation Voltage	$V_{PEAK} = 10$ kV, 1.2 μ s rise time, 50 μ s, 50% fall time	V_{IOSM}	6250	V_{PEAK}
Safety Limiting Values	Maximum value allowed in the event of a failure (see Figure 4)			
Case Temperature		T_S	150	$^{\circ}$ C
Total Power Dissipation at 25 $^{\circ}$ C		I_{S1}	1.64	W
Insulation Resistance at T_S	$V_{IO} = 500$ V	R_S	$>10^9$	Ω

Table 15. 20-Lead SSOP (RS-20)

Description	Conditions	Symbol	Characteristic	Unit
Installation Classification per DIN VDE 0110 For Rated Mains Voltage ≤ 150 V rms For Rated Mains Voltage ≤ 300 V rms For Rated Mains Voltage ≤ 400 V rms			I to IV I to IV I to III	
Climatic Classification			40/105/21	
Pollution Degree per DIN VDE 0110, Table 1			2	
Maximum Working Insulation Voltage		V_{IORM}	849	V_{PEAK}
Input-to-Output Test Voltage, Method b1	$V_{IORM} \times 1.875 = V_{pd(m)}$, 100% production test, $t_{ini} = t_m = 1$ sec, partial discharge < 5 pC	$V_{pd(m)}$	1592	V_{PEAK}
Input-to-Output Test Voltage, Method a After Environmental Tests Subgroup 1	$V_{IORM} \times 1.5 = V_{pd(m)}$, $t_{ini} = 60$ sec, $t_m = 10$ sec, partial discharge < 5 pC	$V_{pd(m)}$	1273	V_{PEAK}
After Input and/or Safety Test Subgroup 2 and Subgroup 3	$V_{IORM} \times 1.2 = V_{pd(m)}$, $t_{ini} = 60$ sec, $t_m = 10$ sec, partial discharge < 5 pC	$V_{pd(m)}$	1018	V_{PEAK}
Highest Allowable Overvoltage		V_{IOTM}	6000	V_{PEAK}
Surge Isolation Voltage		V_{IOSM}	6000	V_{PEAK}
Safety Limiting Values	$V_{PEAK} = 10$ kV, 1.2 μ s rise time, 50 μ s, 50% fall time Maximum value allowed in the event of a failure (see Figure 4)			
Case Temperature		T_S	150	$^{\circ}C$
Total Power Dissipation at 25 $^{\circ}C$		I_{S1}	2.5	W
Insulation Resistance at T_S	$V_{IO} = 500$ V	R_S	$>10^9$	Ω

INTRINSIC SAFETY

The [ADuM1440/ADuM1441/ADuM1442/ADuM1445/ADuM1446/ADuM1447](#) support intrinsic safety for IS to IS applications under IEC 60079-11, and carry ATEX and IECEx certifications. These devices do not currently support IS to non IS galvanic isolation applications due to the minimum insulation requirements of IEC60079-11.

Product Conformity Certificate

Sira 16ATEX2265U and IECEx SIR 16.0091U

Special Conditions for Safe Use

These components are certified to comply with IEC 60079-11:2011. When one of these components is used in equipment, the component is to be fitted on a PCB inside a suitable enclosure and recertified as equipment. The creepage and clearance distances across the isolating component have been evaluated, but the distances to other circuitry remain the responsibility of the user of the certified equipment.

This assembly is an isolating component between separate intrinsically safe circuits. It is recommended that the assembly be connected to suitably certified intrinsically safe circuits considering the entity parameters in Table 16.

Table 16. IS Entity Parameters

Package Type	Entity Parameters Side 1 ¹	Entity Parameters Side 2
16-Lead QSOP	$U_i = 42$ V, $I_i = 275$ mA, $P_i = 1.3$ W, $L_i = 0$, $C_i = 4$ pF	$U_i = 42$ V, $I_i = 275$ mA, $P_i = 1.3$ W, $L_i = 0$, $C_i = 4$ pF
20-Lead SSOP	$U_i = 42$ V, $I_i = 275$ mA, $P_i = 1.3$ W, $L_i = 0$, $C_i = 4$ pF	$U_i = 42$ V, $I_i = 275$ mA, $P_i = 1.3$ W, $L_i = 0$, $C_i = 4$ pF

¹ L_i is defined as input inductance, C_i is input capacitance, P_i is input power, U_i is input voltage, and I_i is input current.

The components (for example, digital isolators) being certified have the following safety ratings listed in Table 17. The temperature class is determined based on Table 17.

Table 17. Temperature Class Information

Package Type	Maximum Power Side 1 (W)	Maximum Power Side 2 (W)	Maximum Component Temperature ($^{\circ}C$)	Ambient Temperature ($^{\circ}C$)
16-Lead QSOP	1.3	1.3	189.8	$-40^{\circ}C$ to $+85^{\circ}C$
20-Lead SSOP	1.3	1.3	218	$-40^{\circ}C$ to $+85^{\circ}C$



Figure 4. Thermal Derating Curve, Dependence of Safety-Limiting Values with Case Temperature per DIN V VDE V 0884-10

Recommended Operating Conditions

Table 18.

Parameter	Symbol	Value
Operating Temperature	T _A	−40°C to +125°C
Supply Voltages ¹	V _{DD1} , V _{DD2}	2.25 V to 3.6 V
Input Signal Rise and Fall Times		1.0 ms

¹ All voltages are relative to their respective grounds. See the DC Correctness section for information on immunity to external magnetic fields.

ABSOLUTE MAXIMUM RATINGS

$T_A = 25^\circ\text{C}$, unless otherwise noted.

Table 19.

Parameter	Rating
Supply Voltages (V_{DD1} , V_{DD2})	-0.5 V to +5 V
Input Voltages (V_{IA} , V_{IB})	-0.5 V to $V_{DD1} + 0.5$ V
Output Voltages (V_{OA} , V_{OB})	-0.5 V to $V_{DD2} + 0.5$ V
Average Output Current per Pin ¹	
Side 1 (I_{O1})	-10 mA to +10 mA
Side 2 (I_{O2})	-10 mA to +10 mA
Common-Mode Transients ²	-100 kV/ μs to +100 kV/ μs
Storage Temperature (T_{ST}) Range	-65°C to +150°C
Ambient Operating Temperature (T_A) Range	-40°C to +125°C

¹ See Figure 4 for maximum safety power values for various temperatures.

² Refers to common-mode transients across the insulation barrier. Common-mode transients exceeding the absolute maximum ratings can cause latch-up or permanent damage.

Stresses at or above those listed under Absolute Maximum Ratings may cause permanent damage to the product. This is a stress rating only; functional operation of the product at these or any other conditions above those indicated in the operational section of this specification is not implied. Operation beyond the maximum operating conditions for extended periods may affect product reliability.

Table 21. Truth Table (Positive Logic) for all Models

V_{IX} Input ^{1,2}	V_{DDI} State ³	V_{DDO} State ⁴	EN_x Input ¹	V_{OX} Output ¹	Description
H	Powered	Powered	L	H	Normal operation; data is high and refresh is enabled.
L	Powered	Powered	L	L	Normal operation; data is low and refresh is enabled.
H	Powered	Powered	H	H	Output is high, and refresh is disabled.
L	Powered	Powered	H	L ⁵	Output is low, and refresh is disabled.
L	Unpowered	Powered	L	Default	Input unpowered. Outputs are in the default state, high for ADuM1440, ADuM1441, and ADuM1442, and low ADuM1445, ADuM1446, and ADuM1447. Outputs return to input state within 150 μs of V_{DDI} power restoration. See the pin function descriptions (Table 22 through Table 24) for more details.
L	Unpowered	Powered	H	Hold	Input unpowered. Outputs are the last state before input power is shut down.
X	Powered	Unpowered	X	Z	Output unpowered. Output pins are in high impedance state. Outputs return to input state within 34 μs of V_{DDO} power restoration. See the pin function descriptions (Table 22 through Table 24) for more details.

¹ H = high, L = low, X = don't care, and Z = high impedance.

² V_{IX} and V_{OX} refer to the input and output signals of a given channel (A, B, C, or D).

³ V_{DDI} refers to the power supply on the input side of a given channel (A, B, C, or D).

⁴ V_{DDO} refers to the power supply on the output side of a given channel (A, B, C, or D).

⁵ Low input must follow a falling edge; otherwise, it can be in the default low state.

Table 20. Maximum Continuous Working Voltage¹

Parameter	Value	Constraint
AC Voltage		
60 Hz Bipolar Waveform	565 V_{PEAK}	50-year minimum lifetime
60 Hz Unipolar Waveform		
Basic Insulation	975 V_{PEAK}	50-year minimum lifetime
DC Voltage		
Basic Insulation	975 V_{PEAK}	50-year minimum lifetime

¹ Refers to continuous voltage magnitude imposed across the isolation barrier. See the Insulation Lifetime section for more details.

ESD CAUTION



ESD (electrostatic discharge) sensitive device. Charged devices and circuit boards can discharge without detection. Although this product features patented or proprietary protection circuitry, damage may occur on devices subjected to high energy ESD. Therefore, proper ESD precautions should be taken to avoid performance degradation or loss of functionality.

PIN CONFIGURATIONS AND FUNCTION DESCRIPTIONS

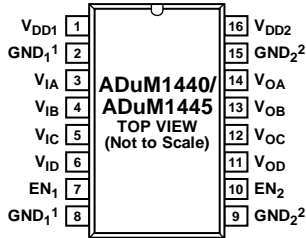

¹PIN 2 AND PIN 8 ARE INTERNALLY CONNECTED. CONNECTING BOTH TO GND₁ IS RECOMMENDED.
²PIN 9 AND PIN 15 ARE INTERNALLY CONNECTED. CONNECTING BOTH TO GND₂ IS RECOMMENDED.

11845-104

Figure 5. ADuM1440/ADuM1445 QSOP Pin Configuration

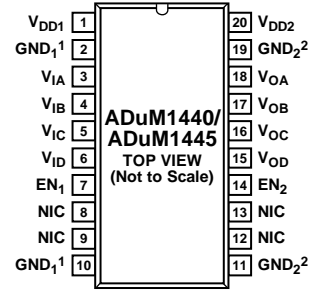

NIC = NOT INTERNALLY CONNECTED.

¹PIN 2 AND PIN 10 ARE INTERNALLY CONNECTED. CONNECTING BOTH TO GND₁ IS RECOMMENDED.
²PIN 11 AND PIN 19 ARE INTERNALLY CONNECTED. CONNECTING BOTH TO GND₂ IS RECOMMENDED.

11845-104

Figure 6. ADuM1440/ADuM1445 SSOP Pin Configuration

Table 22. ADuM1440/ADuM1445 Pin Function Descriptions¹

QSOP Pin No. ²	SSOP Pin No.	Mnemonic	Description
1	1	V _{DD1}	Supply Voltage for Isolator Side 1 (2.25 V to 3.6 V). Connect a ceramic bypass capacitor in the 0.01 μF to 0.1 μF range between V _{DD1} (Pin 1) and GND ₁ (Pin 2).
2, 8	2, 10	GND ₁	Ground 1. Ground reference for Isolator Side 1. Pin 2 and Pin 8 are internally connected, and connecting both to GND ₁ is recommended.
3	3	V _{IA}	Logic Input A.
4	4	V _{IB}	Logic Input B.
5	5	V _{IC}	Logic Input C.
6	3	V _{ID}	Logic Input D.
7	7	EN ₁	Refresh/Watchdog Enable 1. Connecting Pin 7 to GND ₁ enables input/output refresh and watchdog functionality for Side 1, supporting standard iCoupler operation. Tying Pin 7 to V _{DD1} disables refresh and watchdog functionality for lowest power operation, see the Applications Information section for a detailed description of this mode. EN ₁ and EN ₂ must be set to the same logic state.
9, 15	11, 19	GND ₂	Ground 2. Ground reference for Isolator Side 2. Pin 9 and Pin 15 are internally connected, and connecting both to GND ₂ is recommended.
10	14	EN ₂	Refresh/Watchdog Enable 2. Connecting Pin 10 to GND ₂ enables input/output refresh and watchdog functionality for Side 2, supporting standard iCoupler operation. Tying Pin 10 to V _{DD2} disables refresh and watchdog functionality for lowest power operation, see the Applications Information section for a detailed description of this mode. EN ₁ and EN ₂ must be set to the same logic state.
11	15	V _{OD}	Logic Output D.
12	16	V _{OC}	Logic Output C.
13	17	V _{OB}	Logic Output B.
14	18	V _{OA}	Logic Output A.
16	20	V _{DD2}	Supply Voltage for Isolator Side 2 (2.25 V to 3.6 V). Connect a ceramic bypass capacitor in the 0.01 μF to 0.1 μF range between V _{DD2} (Pin 16) and GND ₂ (Pin 15).
N/A	8, 9, 12, 13	NC	No Connect. Do not connect to this pin.

¹ Reference the AN-1109 Application Note for specific layout guidelines.

² N/A = not applicable.



¹PIN 2 AND PIN 8 ARE INTERNALLY CONNECTED. CONNECTING BOTH TO GND₁ IS RECOMMENDED.
²PIN 9 AND PIN 15 ARE INTERNALLY CONNECTED. CONNECTING BOTH TO GND₂ IS RECOMMENDED.

11846-005



NIC = NOT INTERNALLY CONNECTED.
¹PIN 2 AND PIN 10 ARE INTERNALLY CONNECTED. CONNECTING BOTH TO GND₁ IS RECOMMENDED.
²PIN 11 AND PIN 19 ARE INTERNALLY CONNECTED. CONNECTING BOTH TO GND₂ IS RECOMMENDED.

11846-108

Figure 7. ADuM1441/ADuM1446 QSOP Pin Configuration

Figure 8. ADuM1441/ADuM1446 SSOP Pin Configuration

Table 23. ADuM1441/ADuM1446 Pin Function Descriptions¹

QSOP Pin No. ²	SSOP Pin No.	Mnemonic	Description
1	1	V _{DD1}	Supply Voltage for Isolator Side 1 (2.25 V to 3.6 V). Connect a ceramic bypass capacitor in the 0.01 μF to 0.1 μF range between V _{DD1} (Pin 1) and GND ₁ (Pin 2).
2, 8	2, 10	GND ₁	Ground 1. Ground reference for Isolator Side 1. Pin 2 and Pin 8 are internally connected, and connecting both to GND ₁ is recommended.
3	3	V _{IA}	Logic Input A.
4	4	V _{IB}	Logic Input B.
5	5	V _{IC}	Logic Input C.
6	3	V _{OD}	Logic Output D.
7	7	EN ₁	Refresh/Watchdog Enable 1. Connecting Pin 7 to GND ₁ enables input/output refresh and watchdog functionality for Side 1, supporting standard <i>iCoupler</i> operation. Tying Pin 7 to V _{DD1} disables refresh and watchdog functionality for lowest power operation, see the Applications Information section for a detailed description of this mode. EN ₁ and EN ₂ must be set to the same logic state.
9, 15	11, 19	GND ₂	Ground 2. Ground reference for Isolator Side 2. Pin 9 and Pin 15 are internally connected, and connecting both to GND ₂ is recommended.
10	14	EN ₂	Refresh/Watchdog Enable 2. Connecting Pin 10 to GND ₂ enables input/output refresh and watchdog functionality for Side 2, supporting standard <i>iCoupler</i> operation. Tying Pin 10 to V _{DD2} disables refresh and watchdog functionality for lowest power operation, see the Applications Information section for a detailed description of this mode. EN ₁ and EN ₂ must be set to the same logic state.
11	15	V _{ID}	Logic Input D.
12	16	V _{OC}	Logic Output C.
13	17	V _{OB}	Logic Output B.
14	18	V _{OA}	Logic Output A.
16	20	V _{DD2}	Supply Voltage for Isolator Side 2 (2.25 V to 3.6 V). Connect a ceramic bypass capacitor in the 0.01 μF to 0.1 μF range between V _{DD2} (Pin 16) and GND ₂ (Pin 15).
N/A	8, 9, 12, 13	NC	No Connect. Do not connect to this pin.

¹ Reference the AN-1109 Application Note for specific layout guidelines.

² N/A = not applicable.

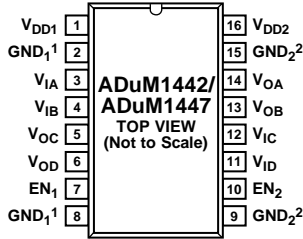

¹PIN 2 AND PIN 8 ARE INTERNALLY CONNECTED. CONNECTING BOTH TO GND₁ IS RECOMMENDED.
²PIN 9 AND PIN 15 ARE INTERNALLY CONNECTED. CONNECTING BOTH TO GND₂ IS RECOMMENDED.

11845-008

Figure 9. ADuM1442/ADuM1447 QSOP Pin Configuration

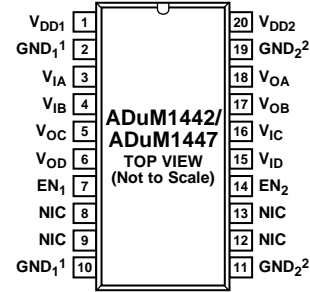

NIC = NOT INTERNALLY CONNECTED.
¹PIN 2 AND PIN 10 ARE INTERNALLY CONNECTED. CONNECTING BOTH TO GND₁ IS RECOMMENDED.
²PIN 11 AND PIN 19 ARE INTERNALLY CONNECTED. CONNECTING BOTH TO GND₂ IS RECOMMENDED.

11845-110

Figure 10. ADuM1442/ADuM1447 SSOP Pin Configuration

Table 24. ADuM1442/ADuM1447 Pin Function Descriptions¹

QSOP Pin No. ²	SSOP Pin No.	Mnemonic	Description
1	1	V _{DD1}	Supply Voltage for Isolator Side 1 (2.25 V to 3.6 V). Connect a ceramic bypass capacitor in the 0.01 μF to 0.1 μF range between V _{DD1} (Pin 1) and GND ₁ (Pin 2).
2, 8	2, 10	GND ₁	Ground 1. Ground reference for Isolator Side 1. Pin 2 and Pin 8 are internally connected, and connecting both to GND ₁ is recommended.
3	3	V _{IA}	Logic Input A.
4	4	V _{IB}	Logic Input B.
5	5	V _{OC}	Logic Output C.
6	3	V _{OD}	Logic Output D.
7	7	EN ₁	Refresh/Watchdog Enable 1. Connecting Pin 7 to GND ₁ enables input/output refresh and watchdog functionality for Side 1, supporting standard iCoupler operation. Tying Pin 7 to V _{DD1} disables refresh and watchdog functionality for lowest power operation, see the Applications Information section for detailed description of this mode. EN ₁ and EN ₂ must be set to the same logic state.
9, 15	11, 19	GND ₂	Ground 2. Ground reference for Isolator Side 2. Pin 9 and Pin 15 are internally connected, and connecting both to GND ₂ is recommended.
10	14	EN ₂	Refresh/Watchdog Enable 2. Connecting Pin 10 to GND ₂ enables input/output refresh and watchdog functionality for Side 2, supporting standard iCoupler operation. Tying Pin 10 to V _{DD2} disables refresh and watchdog functionality for lowest power operation, see the Applications Information section for a detailed description of this mode. EN ₁ and EN ₂ must be set to the same logic state.
11	15	V _{ID}	Logic Input D.
12	16	V _{IC}	Logic Input C.
13	17	V _{OB}	Logic Output B.
14	18	V _{OA}	Logic Output A.
16	20	V _{DD2}	Supply Voltage for Isolator Side 2 (2.25 V to 3.6 V). Connect a ceramic bypass capacitor in the 0.01 μF to 0.1 μF range between V _{DD2} (Pin 16) and GND ₂ (Pin 15).
N/A	8, 9, 12, 13	NC	No Connect. Do not connect to this pin.

¹ Reference the AN-1109 Application Note for specific layout guidelines.

² N/A = not applicable.

TYPICAL PERFORMANCE CHARACTERISTICS

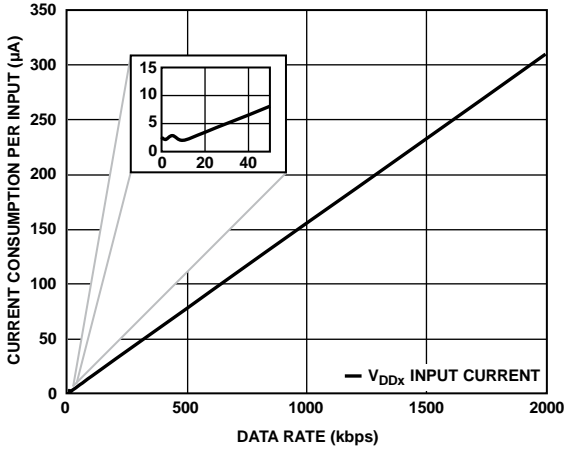

Figure 11. Current Consumption per Input vs. Data Rate for 2.5 V, $EN_x = \text{Low Operation}$

11945-007

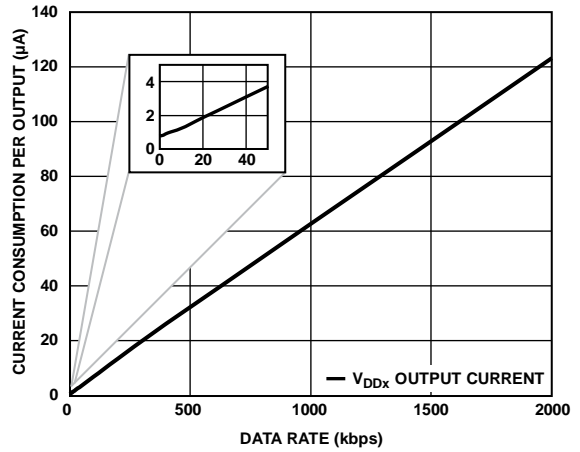

Figure 14. Current Consumption per Output vs. Data Rate for 3.3 V, $EN_x = \text{Low Operation}$

11945-010

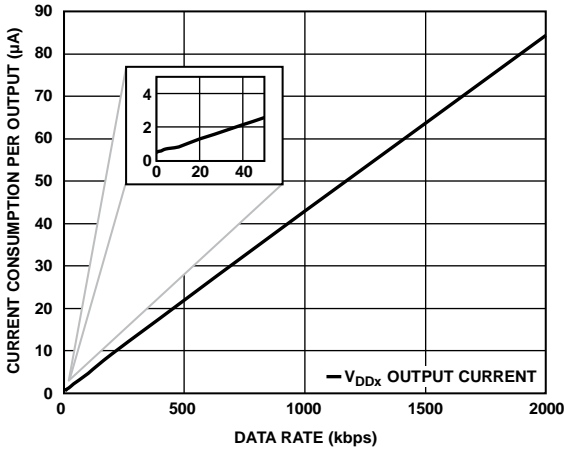

Figure 12. Current Consumption per Output vs. Data Rate for 2.5 V, $EN_x = \text{Low Operation}$

11945-008

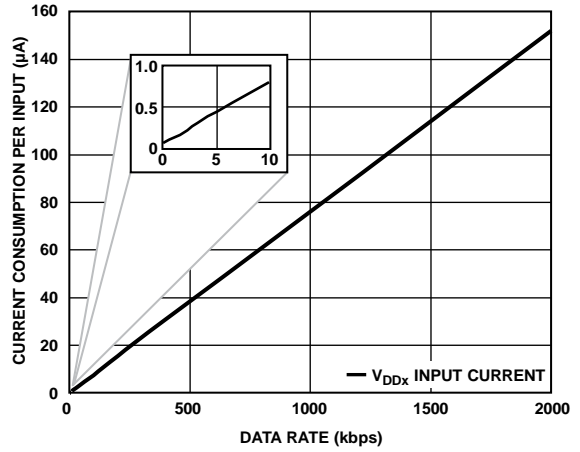

Figure 15. Current Consumption per Input vs. Data Rate for 2.5 V, $EN_x = \text{High Operation}$

11945-011

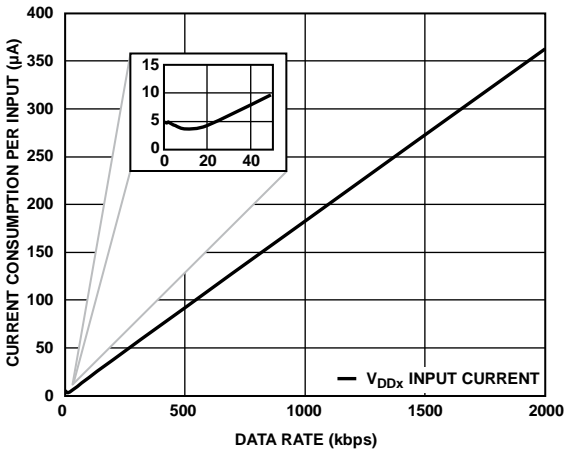

Figure 13. Current Consumption per Input vs. Data Rate for 3.3 V, $EN_x = \text{Low Operation}$

11945-009

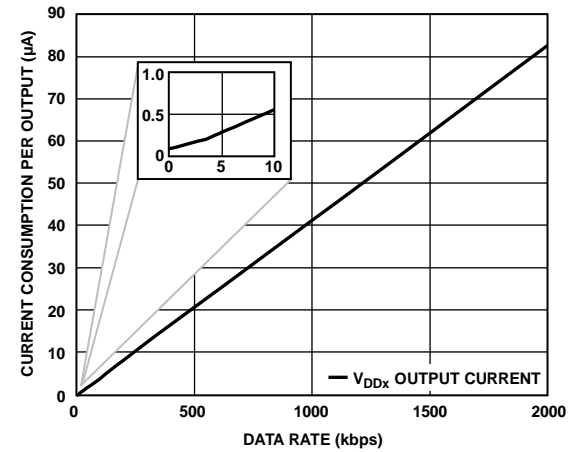

Figure 16. Current Consumption per Output vs. Data Rate for 2.5 V, $EN_x = \text{High Operation}$

11945-012



Figure 17. Current Consumption per Input vs. Data Rate for $V_{DDx} = 3.3\text{ V}$, $EN_x = \text{High Operation}$



Figure 20. I_{DDx} Current per Input vs. Data Input Voltage for $V_{DDx} = 2.5\text{ V}$



Figure 18. Current Consumption per Output vs. Data Rate for $V_{DDx} = 3.3\text{ V}$, $EN_x = \text{High Operation}$



Figure 21. Typical Input and Output Supply Current per Channel vs. Temperature for $V_{DDx} = 2.5\text{ V}$, Data Rate = 100 kbps

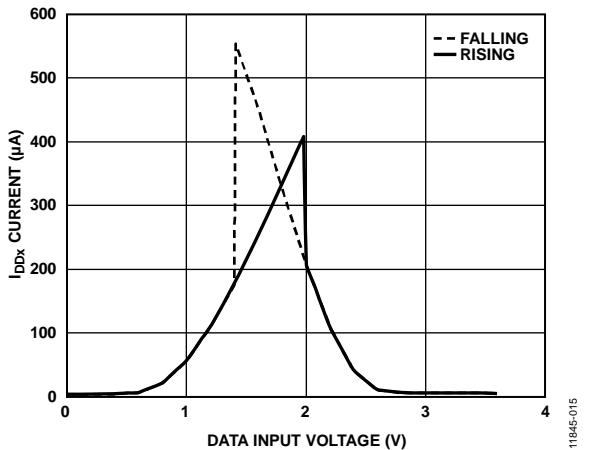

Figure 19. Typical I_{DDx} Current per Input vs. Data Input Voltage for $V_{DDx} = 3.3\text{ V}$



Figure 22. Typical Input and Output Supply Current per Channel vs. Temperature for $V_{DDx} = 3.3\text{ V}$, Data Rate = 100 kbps



Figure 23. Typical Input and Output Supply Current per Channel vs. Temperature for $V_{DDx} = 2.5\text{ V}$, Data Rate = 1000 kbps

11845-119

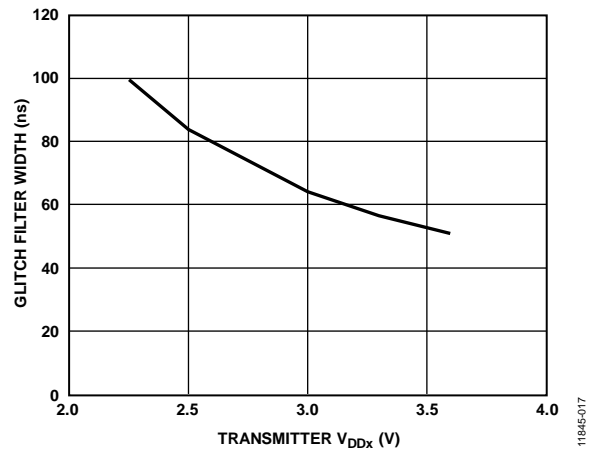

Figure 26. Typical Glitch Filter Operation Threshold

11845-017

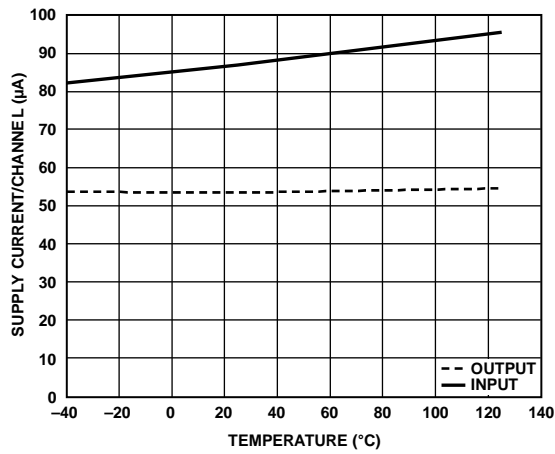

Figure 24. Typical Input and Output Supply Current per Channel vs. Temperature for $V_{DDx} = 3.3\text{ V}$, Data Rate = 1000 kbps

11845-120

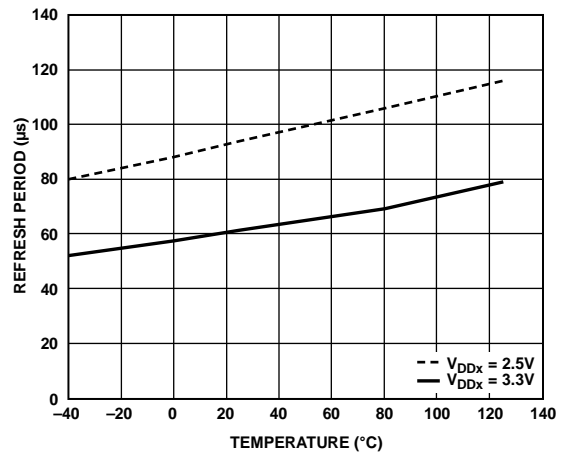

Figure 27. Typical Refresh Period vs. Temperature for 3.3 V and 2.5 V Operation

11845-122

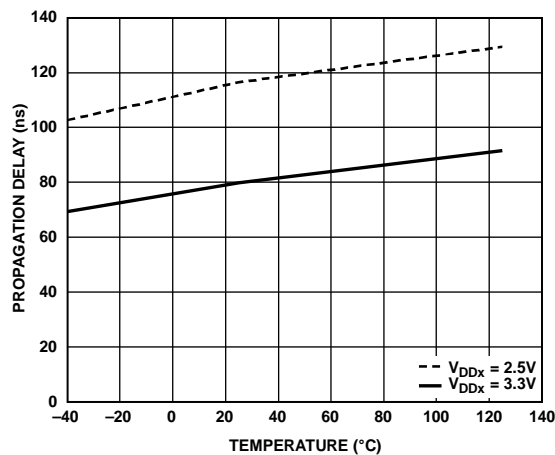

Figure 25. Typical Propagation Delay vs. Temperature for $V_{DDx} = 3.3\text{ V}$ or $V_{DDx} = 2.5\text{ V}$

11845-121



Figure 28. Typical Refresh Period vs. V_{DDx} Voltage

11845-123

APPLICATIONS INFORMATION

PCB LAYOUT

The [ADuM1440/ADuM1441/ADuM1442/ADuM1445/ADuM1446/ADuM1447](#) digital isolators require no external interface circuitry for the logic interfaces. Power supply bypassing is strongly recommended at both input and output supply pins: V_{DD1} and V_{DD2} (see Figure 29). Choose a capacitor value between 0.01 μF and 0.1 μF . The total lead length between both ends of the capacitor and the input power supply pin must not exceed 20 mm.

Using proper PCB design choices, the [ADuM1440/ADuM1441/ADuM1442/ADuM1445/ADuM1446/ADuM1447](#) readily meets CISPR 22 Class A (and FCC Class A) emissions standards, as well as the more stringent CISPR 22 Class B (and FCC Class B) standards in an unshielded environment. Refer to the [AN-1109 Application Note, Recommendations for Control of Radiated Emissions with iCoupler Devices](#), for PCB-related EMI mitigation techniques, including board layout and stack-up issues.



Figure 29. Recommended Printed Circuit Board Layout, QSOP

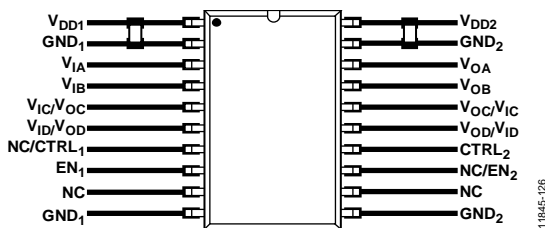

Figure 30. Recommended Printed Circuit Board Layout, SSOP

For applications involving high common-mode transients, it is important to minimize board coupling across the isolation barrier. Furthermore, design the board layout so that any coupling that does occur equally affects all pins on a given component side. Failure to ensure this can cause voltage differentials between pins exceeding the absolute maximum ratings of the device, thereby leading to latch-up or permanent damage.

PROPAGATION DELAY-RELATED PARAMETERS

These products are optimized for minimum power consumption by eliminating as many internal bias currents as possible. As a result, the timing characteristics are more sensitive to operating voltage and temperature than in standard *iCoupler* products. Refer to Figure 21 through Figure 28 for the expected variation of these parameters.

Propagation delay is a parameter defined as the time it takes a logic signal to propagate through a component. The input-to-output propagation delay time for a high-to-low transition can differ from the propagation delay time of a low-to-high transition.

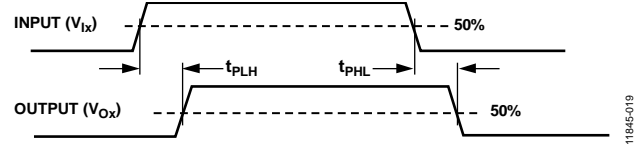

Figure 31. Propagation Delay Parameters

Pulse width distortion is the maximum difference between these two propagation delay values and an indication of how accurately the timing of the input signal is preserved.

Channel-to-channel matching is the maximum amount of time the propagation delay differs between channels within a single [ADuM1440/ADuM1441/ADuM1442/ADuM1445/ADuM1446/ADuM1447](#) component.

Propagation delay skew is the maximum amount of time the propagation delay differs between multiple [ADuM1440/ADuM1441/ADuM1442/ADuM1445/ADuM1446/ADuM1447](#) components operating under the same conditions.

In edge-based systems, it is critical to reject pulses that are too short to be handled by the encode and decode circuits. The [ADuM1440/ADuM1441/ADuM1442/ADuM1445/ADuM1446/ADuM1447](#) implement a glitch filter to reject pulses less than the glitch filter operating threshold. This threshold depends on the operating voltage, as shown in Figure 26. Any pulse shorter than the glitch filter does not pass to the output. When the refresh circuit is enabled, pulses that match the glitch filter width have a small probability of being stretched until corrected by the next refresh cycle, or by the next valid data through that channel. To avoid issues with pulse stretching, observe the minimum pulse width requirements listed in the switching specifications.

DC CORRECTNESS

Standard Operating Mode

Positive and negative logic transitions at the isolator input cause narrow (~ 1 ns) pulses to be sent to the decoder using the transformer. The decoder is bistable and is, therefore, either set or reset by the pulses, indicating input logic transitions. When refresh and watchdog functions are enabled by pulling EN_1 and EN_2 low, in the absence of logic transitions at the input for more than $\sim 140 \mu\text{s}$, a periodic set of refresh pulses indicative of the correct input state is sent to ensure dc correctness at the output. If the decoder receives no internal pulses of more than approximately $200 \mu\text{s}$, the input side is assumed unpowered or nonfunctional, in which case, the isolator watchdog circuit forces the output to a default state. The default state is either high as in the [ADuM1440](#), [ADuM1441](#), and [ADuM1442](#) versions, or low as in the [ADuM1445](#), [ADuM1446](#), and [ADuM1447](#) versions.

Low Power Operating Mode

The [ADuM1440/ADuM1441/ADuM1442/ADuM1445/ADuM1446/ADuM1447](#) allow the refresh and watchdog functions to be disabled by pulling EN₁ and EN₂ to logic high for the lowest power consumption. These control pins must be set to the same value on each side of the component for proper operation.

In this mode, the current consumption of the chip drops to the microamp range. However, be careful when using this mode because dc correctness is no longer guaranteed at startup. For example, if the following sequence of events occurs:

1. Power is applied to Side 1
2. A high level is asserted on the V_{IA} input
3. Power is applied to Side 2

The high on V_{IA} is not automatically transferred to the Side 2 V_{OA}, and there can be a level mismatch that is not corrected until a transition occurs at V_{IA}. After power is stable on each side and a transition occurs on the input of the channel, that channel's input and output state is correctly matched. This contingency can be addressed in several ways, such as sending dummy data, or toggling refresh on for a short period to force synchronization after turn on.

Recommended Input Voltage for Low Power Operation

The [ADuM1440/ADuM1441/ADuM1442/ADuM1445/ADuM1446/ADuM1447](#) implement Schmitt trigger input buffers so that the devices operate cleanly in low data rate or noisy environments. Schmitt triggers allow a small amount of shoot through current when their input voltage is not approximate to either V_{DDx} or GND_x levels. This is because the two transistors are both slightly on when input voltages are in the middle of the supply range. For many digital devices, this leakage is not a large portion of the total supply current and may not be noticed; however, in the ultralow power [ADuM1440/ADuM1441/ADuM1442/ADuM1445/ADuM1446/ADuM1447](#), this leakage can be larger than the total operating current of the device and cannot be ignored.

To achieve optimum power consumption with the [ADuM1440/ADuM1441/ADuM1442/ADuM1445/ADuM1446/ADuM1447](#), always drive the inputs as near to V_{DDx} or GND_x levels as possible. Figure 19 and Figure 20 illustrate the shoot through leakage of an input; therefore, whereas the logic thresholds of the input are standard CMOS levels, optimum power performance is achieved when the input logic levels are driven within 0.5 V of either V_{DDx} or GND_x levels.

MAGNETIC FIELD IMMUNITY

The magnetic field immunity of the [ADuM1440/ADuM1441/ADuM1442/ADuM1445/ADuM1446/ADuM1447](#) is determined by the changing magnetic field, which induces a voltage in the receiving coil of the transformer large enough to either falsely set or reset the decoder. The following analysis defines the conditions under which this can occur. The 3.3 V operating condition of the [ADuM1440/ADuM1441/ADuM1442/ADuM1445/ADuM1446/ADuM1447](#) is examined because it represents the most typical mode of operation.

The pulses at the transformer output have an amplitude greater than 1.0 V. The decoder has a sensing threshold at about 0.5 V, thus establishing a 0.5 V margin in which induced voltages can be tolerated. The voltage induced across the receiving coil is given by

$$V = (-d\beta/dt) \sum \pi r_n^2; n = 1, 2, \dots, N$$

where:

β is magnetic flux density (gauss).

r_n is the radius of the nth turn in the receiving coil (cm).

N is the number of turns in the receiving coil.

Given the geometry of the receiving coil in the [ADuM1440/ADuM1441/ADuM1442/ADuM1445/ADuM1446/ADuM1447](#) and an imposed requirement that the induced voltage be, at most, 50% of the 0.5 V margin at the decoder, a maximum allowable magnetic field at a given frequency can be calculated. The result is shown in Figure 32.



Figure 32. Maximum Allowable External Magnetic Flux Density

For example, at a magnetic field frequency of 1 MHz, the maximum allowable magnetic field of 0.5 kgauss induces a voltage of 0.25 V at the receiving coil. This is about 50% of the sensing threshold and does not cause a faulty output transition. Similarly, if such an event occurred during a transmitted pulse (and was of the worst-case polarity), it would reduce the received pulse from >1.0 V to 0.75 V, still well above the 0.5 V sensing threshold of the decoder.

The preceding magnetic flux density values correspond to specific current magnitudes at given distances from the [ADuM1440/ADuM1441/ADuM1442/ADuM1445/ADuM1446/ADuM1447](#) transformers. Figure 33 shows these allowable current magnitudes as a function of frequency for selected distances. As shown, the [ADuM1440/ADuM1441/ADuM1442/ADuM1445/ADuM1446/ADuM1447](#) are extremely immune and can be affected only by extremely large currents operating at a high frequency very near to the component. For the 1 MHz example noted previously, a 1.2 kA current would have to be placed 5 mm away from the [ADuM1440/ADuM1441/ADuM1442/ADuM1445/ADuM1446/ADuM1447](#) to affect the operation of the component.



Figure 33. Maximum Allowable Current for Various Current-to-ADuM1440/ADuM1441/ADuM1442/ADuM1445/ADuM1446/ADuM1447 Spacings

Note that at combinations of strong magnetic field and high frequency, any loops formed by PCB traces can induce error voltages sufficiently large enough to trigger the thresholds of succeeding circuitry. Take care in the layout of such traces to avoid this possibility.

POWER CONSUMPTION

The supply current at a given channel of the ADuM1440/ADuM1441/ADuM1442/ADuM1445/ADuM1446/ADuM1447 isolator is a function of the supply voltage, the data rate of the channel, and the output load of the channel.

For each input channel, the supply current is given by

$$I_{DDI} = I_{DDI(Q)} \quad f \leq 0.5 f_r$$

$$I_{DDI} = I_{DDI(D)} \times (2f - f_r) + I_{DDI(Q)} \quad f > 0.5 f_r$$

For each output channel, the supply current is given by

$$I_{DDO} = I_{DDO(Q)} \quad f \leq 0.5 f_r$$

$$I_{DDO} = (I_{DDO(D)} + (0.5 \times 10^{-3}) \times C_L \times V_{DDO}) \times (2f - f_r) + I_{DDO(Q)} \quad f > 0.5 f_r$$

where:

$I_{DDI(D)}$, $I_{DDO(D)}$ are the input and output dynamic supply currents per channel (mA/Mbps).

$I_{DDI(Q)}$, $I_{DDO(Q)}$ are the specified input and output quiescent supply currents (mA).

f is the input logic signal frequency (MHz); it is half the input data rate, expressed in units of Mbps.

f_r is the input stage refresh rate (Mbps).

C_L is the output load capacitance (pF).

V_{DDO} is the output supply voltage (V).

To calculate the total V_{DD1} and V_{DD2} supply current, the supply currents for each input and output channel corresponding to V_{DD1} and V_{DD2} are calculated and totaled. Figure 11 through Figure 18 show per channel supply currents as a function of data rate for an unloaded output condition.

The ADuM1440/ADuM1441/ADuM1442/ADuM1445/ADuM1446/ADuM1447 devices are intended to operate at an ultralow current. This is achieved by operating the part at a low average data rate, either by bursting data at high speed at a low duty factor or by running low bit rates. If data is burst at high data rates, the part sits quiescent for the majority of the time, at low data rates, the power consumption approaches the quiescent power consumption. Table 25 shows the typical current for an input and output channel pair as well as the total power dissipated for that channel. The total power is summed across both sides of the device, so the power is being drawn from two different supplies. However, it shows how the power depends on the V_{DD} values and the state of the refresh.

Table 25. Typical Total Power Dissipation Per Channel

State of Refresh	Typical Input Channel		Typical Output Channel		Power/Ch
	V_{DDI}	$I_{DDI(Q)}$	V_{DDO}	$I_{DDO(Q)}$	
Enabled	2.5 V	2.6 μ A	2.5 V	0.5 μ A	7.8 μ W
	3.3 V	4.8 μ A	3.3 V	0.8 μ A	18.5 μ W
Disabled	2.5 V	0.05 μ A	2.5 V	0.05 μ A	0.3 μ W
	3.3 V	0.12 μ A	3.3 V	0.13 μ A	0.8 μ W

INSULATION LIFETIME

All insulation structures eventually break down when subjected to voltage stress over a sufficiently long period. The rate of insulation degradation is dependent on the characteristics of the voltage waveform applied across the insulation. In addition to the testing performed by the regulatory agencies, Analog Devices carries out an extensive set of evaluations to determine the lifetime of the insulation structure within the ADuM1440/ADuM1441/ADuM1442/ADuM1445/ADuM1446/ADuM1447.

Analog Devices performs accelerated life testing using voltage levels higher than the rated continuous working voltage. Acceleration factors for several operating conditions are determined. These factors allow calculation of the time to failure at the actual working voltage. The values shown in Table 20 summarize the peak voltage for 50 years of service life for a bipolar ac operating condition and the maximum CSA approved working voltages. In many cases, the approved working voltage is higher than the 50-year service life voltage. Operation at these high working voltages can lead to shortened insulation life, in some cases.

The insulation lifetime of the ADuM1440/ADuM1441/ADuM1442/ADuM1445/ADuM1446/ADuM1447 depends on the voltage waveform type imposed across the isolation barrier. The iCoupler insulation structure degrades at different rates depending on whether the waveform is bipolar ac, unipolar ac, or dc. Figure 34, Figure 35, and Figure 36 illustrate these different isolation voltage waveforms.

Bipolar ac voltage is the most stringent environment. The goal of a 50-year operating lifetime under the ac bipolar condition determines the Analog Devices recommended maximum working voltage.

In the case of unipolar ac or dc voltage, the stress on the insulation is significantly lower. This allows operation at higher working voltages while still achieving a 50-year service life. The working voltages listed in Table 20 can be applied while maintaining the 50-year minimum lifetime provided the voltage conforms to either the unipolar ac or dc voltage case. Treat any cross-insulation voltage waveform that does not conform to Figure 35 or Figure 36 as a bipolar ac waveform, and limit its peak voltage to the 50-year lifetime voltage value listed in Table 20.

Note that the voltage presented in Figure 35 is shown as sinusoidal for illustration purposes only. It is meant to represent any voltage waveform varying between 0 V and some limiting value. The limiting value can be positive or negative, but the voltage cannot cross 0 V.



Figure 34. Bipolar AC Waveform



Figure 35. Unipolar AC Waveform



Figure 36. DC Waveform

OUTLINE DIMENSIONS



COMPLIANT TO JEDEC STANDARDS MO-137-AB
 CONTROLLING DIMENSIONS ARE IN INCHES; MILLIMETER DIMENSIONS
 (IN PARENTHESES) ARE ROUNDED-OFF INCH EQUIVALENTS FOR
 REFERENCE ONLY AND ARE NOT APPROPRIATE FOR USE IN DESIGN.

Figure 37. 16-Lead Shrink Small Outline Package [QSOP]
 (RQ-16)
 Dimensions shown in inches and (millimeters)

09-12-2014-A



COMPLIANT TO JEDEC STANDARDS MO-150-AE

Figure 38. 20-Lead Shrink Small Outline Package [SSOP]
 (RS-20)
 Dimensions shown in millimeters

0601 06-A

ORDERING GUIDE

Model ^{1,2}	Number of Inputs, V _{DD1} Side	Number of Inputs, V _{DD2} Side	Maximum Data Rate (Mbps)	Default Output State	Maximum Propagation Delay, 3.3 V (ns)	Temperature Range	Package Description	Package Option
ADuM1440ARQZ	4	0	2	High	180	-40°C to +125°C	16-Lead QSOP	RQ-16
ADuM1441ARQZ	3	1	2	High	180	-40°C to +125°C	16-Lead QSOP	RQ-16
ADuM1442ARQZ	2	2	2	High	180	-40°C to +125°C	16-Lead QSOP	RQ-16
ADuM1445ARQZ	4	0	2	Low	180	-40°C to +125°C	16-Lead QSOP	RQ-16
ADuM1446ARQZ	3	1	2	Low	180	-40°C to +125°C	16-Lead QSOP	RQ-16
ADuM1447ARQZ	2	2	2	Low	180	-40°C to +125°C	16-Lead QSOP	RQ-16
ADuM1440ARSZ	4	0	2	High	180	-40°C to +125°C	20-Lead SSOP	RS-20
ADuM1441ARSZ	3	1	2	High	180	-40°C to +125°C	20-Lead SSOP	RS-20
ADuM1442ARSZ	2	2	2	High	180	-40°C to +125°C	20-Lead SSOP	RS-20
ADuM1445ARSZ	4	0	2	Low	180	-40°C to +125°C	20-Lead SSOP	RS-20
ADuM1446ARSZ	3	1	2	Low	180	-40°C to +125°C	20-Lead SSOP	RS-20
ADuM1447ARSZ	2	2	2	Low	180	-40°C to +125°C	20-Lead SSOP	RS-20
EVAL-ADUM1441EBZ							Evaluation Board	

¹ Z = RoHS Compliant Part.

² Tape and reel is available. The addition of the -RL7 suffix indicates that the product is shipped on 7" tape and reel.



Компания «ЭлектроПласт» предлагает заключение долгосрочных отношений при поставках импортных электронных компонентов на взаимовыгодных условиях!

Наши преимущества:

- Оперативные поставки широкого спектра электронных компонентов отечественного и импортного производства напрямую от производителей и с крупнейших мировых складов;
- Поставка более 17-ти миллионов наименований электронных компонентов;
- Поставка сложных, дефицитных, либо снятых с производства позиций;
- Оперативные сроки поставки под заказ (от 5 рабочих дней);
- Экспресс доставка в любую точку России;
- Техническая поддержка проекта, помощь в подборе аналогов, поставка прототипов;
- Система менеджмента качества сертифицирована по Международному стандарту ISO 9001;
- Лицензия ФСБ на осуществление работ с использованием сведений, составляющих государственную тайну;
- Поставка специализированных компонентов (Xilinx, Altera, Analog Devices, Intersil, Interpoint, Microsemi, Aeroflex, Peregrine, Syfer, Eurofarad, Texas Instrument, Miteq, Cobham, E2V, MA-COM, Hittite, Mini-Circuits, General Dynamics и др.);

Помимо этого, одним из направлений компании «ЭлектроПласт» является направление «Источники питания». Мы предлагаем Вам помощь Конструкторского отдела:

- Подбор оптимального решения, техническое обоснование при выборе компонента;
- Подбор аналогов;
- Консультации по применению компонента;
- Поставка образцов и прототипов;
- Техническая поддержка проекта;
- Защита от снятия компонента с производства.



Как с нами связаться

Телефон: 8 (812) 309 58 32 (многоканальный)

Факс: 8 (812) 320-02-42

Электронная почта: org@eplast1.ru

Адрес: 198099, г. Санкт-Петербург, ул. Калинина, дом 2, корпус 4, литера А.