



Features

- Wide input range 100~305V AC(Class I)
- Full power output at 70~100% Constant power mode operation
- Metal case with IP67, suitable for outdoor application
- Surge protection with 6K V/4K V (10K V/6K V optional)
- 3 in 1 dimming function (Dim to off and Isolation design)
- India (EESL) version, can survive input voltage stress of 440Vac for 48 hours
- Protection functions: OVP/SCP/OCP/OTP
- Life time >50,000 hrs. and 5 years warranty

Applications

- Skyscraper lighting
- Street lighting
- Floodlight Lighting
- Stage lighting
- Fishing lighting
- Horticulture lighting
- Bay lighting
- Type HL for use in class I, Division 2

Description

XLG-240 series is a 240W LED AC/DC driver featuring the constant power mode. XLG-240 operates from 100~305VAC and offers models with different rated current ranging between 700mA and 6.66A. Thanks to the high efficiency up to 93%, with the fanless design, the entire series is able to operate for -40°C~+90°C case temperature under free air convection. The design of metal housing and IP67 ingress protection level allows this series to fit both indoor and outdoor applications. Moreover the innovative environment-adaptive capability allows this series to reliably light on the LEDs for all kinds of application environments in almost any spots that may install LED luminaires in the world. XLG-240 is designed with the latest version of IEC61347/GB7000.1-2015 and UL8750 international safety regulations. The output and dimming circuit are also completely in accordance with the new regulations with isolation to ensure the user and luminaire system safety during installation.

Model Encoding

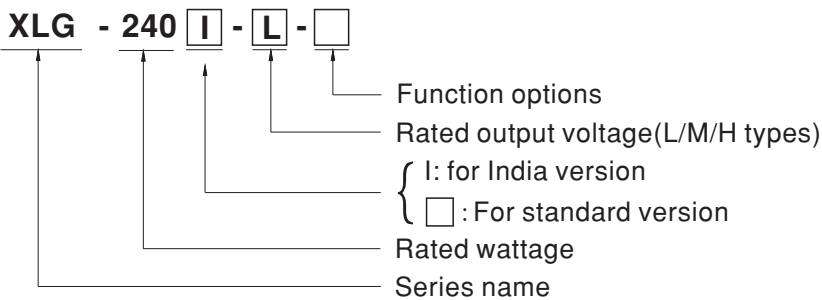

| Type | Function | Note |
|-------|---|------------|
| Blank | Io and Vo fixed.(For harsh environment) | By request |
| A | Io adjustable via built-in potentiometer | In Stock |
| AB | Io adjustable via built-in potentiometer + 3 in 1 dimming function (0~10Vdc, 10V PWM signal and resistance) | In Stock |

SPECIFICATION

| MODEL | | XLG-240-L-□ | XLG-240-M-□ | XLG-240-H-□ | |
|--------------------------------------|--|--|------------------|---|--|
| OUTPUT | RATED CURRENT | 700mA | 1400mA | 4900mA | |
| | RATED POWER | 239.4W | 239.4W | 239.6W | |
| | CONSTANT CURRENT REGION <small>Note.2</small> | 178~ 342V | 90 ~171V | 27 ~ 56V | |
| | FULL POWER CURRENT RANGE | 700~1050mA | 1400~2100mA | 4280~6660mA | |
| | OPEN CIRCUIT VOLTAGE (max.) | 370V | 186V | 60V | |
| | CURRENT ADJ. RANGE | Adjustable for A/AB-Type only (via the built-in potentiometer) | | | |
| | | 350~1050mA | 700~2100mA | 2200~6660mA | |
| | CURRENT RIPPLE | 4.0%(@ Load ≥50% rated voltage) | | | |
| | CURRENT TOLERANCE | ±4% | | | |
| SET UP TIME | 500ms/230VAC, 1200ms/115VAC | | | | |
| INPUT | VOLTAGE RANGE <small>Note.5</small> | 100 ~ 305VAC 142VDC ~ 431VDC (Please refer to "STATIC CHARACTERISTIC" and "DRIVING METHODS OF LED MODULE" section) | | | |
| | FREQUENCY RANGE | 47 ~ 63Hz | | | |
| | POWER FACTOR (Typ.) | PF ≥ 0.97 / 115VAC, PF ≥ 0.95 / 230VAC, PF ≥ 0.92 / 277VAC at full load (Please refer to "Power Factor Characteristic" section) | | | |
| | TOTAL HARMONIC DISTORTION | THD < 10% (@ load ≥ 50% at 115VAC/230VAC, @load ≥ 75% at 277VAC) Please refer to "TOTAL HARMONIC DISTORTION (THD)" section | | | |
| | EFFICIENCY (Typ.) | 93% | 92.5% | 91% | |
| | AC CURRENT (Typ.) | 2.7A / 115VAC | 1.3A / 230VAC | 1.1A / 277VAC | |
| | INRUSH CURRENT(Typ.) | COLD START 85A(twidth=500μs measured at 50% Ipeak) at 230VAC; Per NEMA 410 | | | |
| | MAX. NO. of PSUs on 16A CIRCUIT BREAKER | 2 unit(circuit breaker of type B) / 4 units(circuit breaker of type C) at 230VAC | | | |
| | LEAKAGE CURRENT | <0.75mA / 277VAC | | | |
| | STANDBY POWER CONSUMPTION | Standby power consumption <0.5W for AB-Type(Dimming OFF) | | | |
| PROTECTION | SHORT CIRCUIT | Hiccup mode or constant current limiting, recovers automatically after fault condition is removed | | | |
| | OVER VOLTAGE | 380 ~ 440V | 190~ 240V | 61 ~ 78V | |
| | | Shut down output voltage, re-power on to recovery | | | |
| | INPUT OVER VOLTAGE <small>Note.7</small> | 320 ~ 370VAC (Shut down output when the input exceeds protection voltage recovers automatically after fault condition is removed) can survive input voltage stress of 440Vac for 48 hours | | | |
| OVER TEMPERATURE | Shut down O/P voltage, recovers automatically after temperature goes down | | | | |
| ENVIRONMENT | WORKING TEMP. | Tcase=-40 ~ +90°C (Please refer to "OUTPUT LOAD vs TEMPERATURE" section) | | | |
| | MAX. CASE TEMP. | Tcase=+90°C | | | |
| | WORKING HUMIDITY | 20 ~ 95% RH non-condensing | | | |
| | STORAGE TEMP., HUMIDITY | -40 ~ +80°C, 10 ~ 95% RH non-condensing | | | |
| | TEMP. COEFFICIENT | ±0.03%/°C (0 ~ 60°C) | | | |
| | VIBRATION | 10 ~ 500Hz, 5G 12min./1cycle, period for 72min. each along X, Y, Z axes | | | |
| SAFETY & EMC <small>(Note 8)</small> | SAFETY STANDARDS | UL8750(type"HL"), CSA C22.2 No. 250.13-12; ENEC EN61347-1, EN61347-2-13 independent, EN62384; GB19510.1, GB19510.14; EAC TP TC 004;IP67 approved | | | |
| | WITHSTAND VOLTAGE | I/P-O/P:3.75KVAC I/P-FG:2KVAC O/P-FG:1.5KVAC | | | |
| | ISOLATION RESISTANCE | I/P-O/P, I/P-FG, O/P-FG:100M Ohms / 500VDC / 25°C / 70% RH | | | |
| | EMC EMISSION | Parameter | Standard | Test Level / Note | |
| | | Conducted | EN55015(CISPR15) | ----- | |
| | | Radiated | EN55015(CISPR15) | ----- | |
| | | Harmonic Current | EN61000-3-2 | Class C @load≥50% | |
| | | Voltage Flicker | EN61000-3-3 | ----- | |
| | EMC IMMUNITY | EN61547 | | | |
| | | Parameter | Standard | Test Level / Note | |
| | | ESD | EN61000-4-2 | Level 3, 8KV air ; Level 2, 4KV contact | |
| | | Radiated | EN61000-4-3 | Level 2 | |
| | | EFT / Burst | EN61000-4-4 | Level 3 | |
| | | Surge | EN61000-4-5 | 4KV/Line-Line 6KV/Line-Earth(6K/10K option) | |
| Conducted | | EN61000-4-6 | Level 2 | | |
| Magnetic Field | | EN61000-4-8 | Level 4 | | |
| Voltage Dips and Interruptions | EN61000-4-11 | >95% dip 0.5 periods, 30% dip 25 periods, >95% interruptions 250 periods | | | |
| OTHERS | MTBF | 830.77K hrs min. Telcordia SR-332(Bellcore) ; 219.75K hrs min. MIL-HDBK-217F (25°C) | | | |
| | DIMENSION | 219*63*35.5mm (L*W*H) | | | |
| | PACKING | 1Kg;16pcs / 16Kg / 0.77CUFT | | | |
| NOTE | <p>1. All parameters NOT specially mentioned are measured at 230VAC input, rated current and 25°C of ambient temperature.</p> <p>2. Please refer to "DRIVING METHODS OF LED MODULE".</p> <p>3. Ripple & noise are measured at 20MHz of bandwidth by using a 12" twisted pair-wire terminated with a 0.1uf & 47uf parallel capacitor.</p> <p>4. Tolerance : includes set up tolerance, line regulation and load regulation.</p> <p>5. De-rating may be needed under low input voltages. Please refer to "STATIC CHARACTERISTIC" sections for details.</p> <p>6. Length of set up time is measured at first cold start. Turning ON/OFF the driver may lead to increase of the set up time.</p> <p>7. Only for XLG-240 I series</p> <p>8. The driver is considered as a component that will be operated in combination with final equipment. Since EMC performance will be affected by the complete installation, the final equipment manufacturers must re-qualify EMC Directive on the complete installation again.</p> <p>9. This series meets the typical life expectancy of >50,000 hours of operation when Tcase, particularly (Tc) point (or Tmp, per DLC), is about 75°C or less.</p> <p>10. Please refer to the warranty statement on MEAN WELL's website at http://www.meanwell.com</p> <p>11. To fulfill requirements of the latest ErP regulation for lighting fixtures, this LED driver can only be used behind a switch without permanently connected to the mains.</p> <p>12. The ambient temperature derating of 3.5°C/1000m with fanless models and of 5°C/1000m with fan models for operating altitude higher than 2000m(6500ft).</p> <p>13. Products sourced from the Americas regions may not have the CCC/PSE/BIS/KC logo. Please contact your MEAN WELL sales for more information.</p> <p>14. For any application note and IP water proof function installation caution, please refer our user manual before using. https://www.meanwell.com/Upload/PDF/LED_EN.pdf</p> <p>15. When the current adjustment is more than 110% of the rated current, it will be enter the Protection state.</p> | | | | |

■ BLOCK DIAGRAM

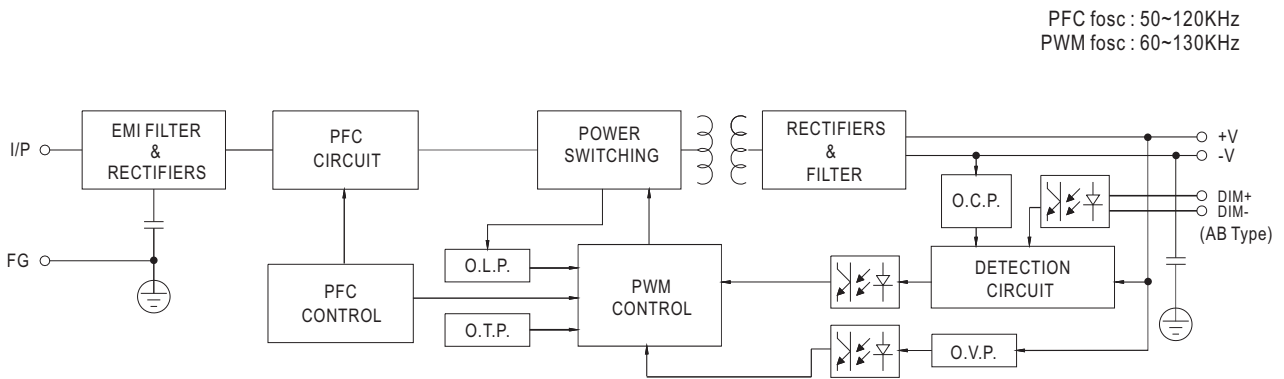

■ DRIVING METHODS OF LED MODULE

※ I-V Operating Area

◎ XLG-240-L

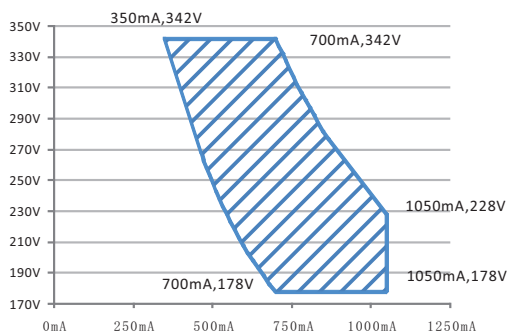

Recommend Performance Region

◎ XLG-240-M

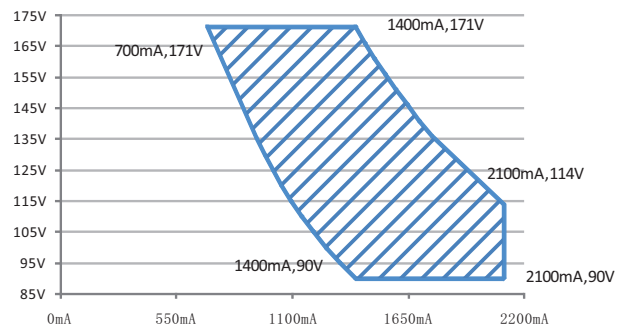

Recommend Performance Region

◎ XLG-240-H

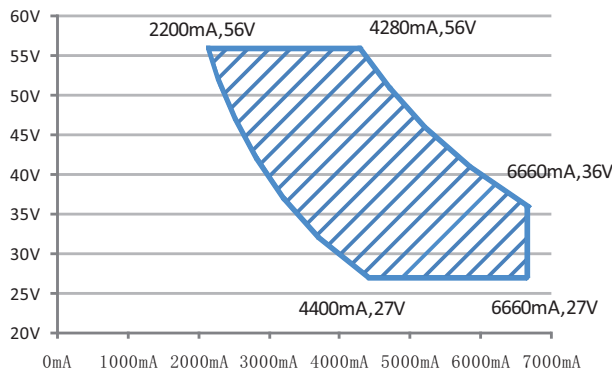

Recommend Performance Region

■ DIMMING OPERATION

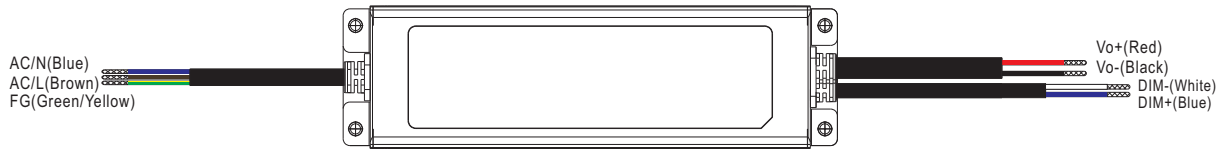

※ **3 in 1 dimming function (for AB-Type)**

- Output constant current level can be adjusted by applying one of the three methodologies between DIM+ and DIM-: 0 ~ 10VDC, or 10V PWM signal or resistance.
- Direct connecting to LEDs is suggested. It is not suitable to be used with additional drivers.
- Dimming source current from power supply: 100 μ A (typ.)

◎ Applying additive 0 ~ 10VDC

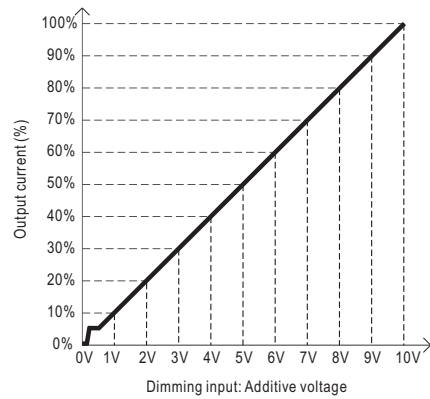
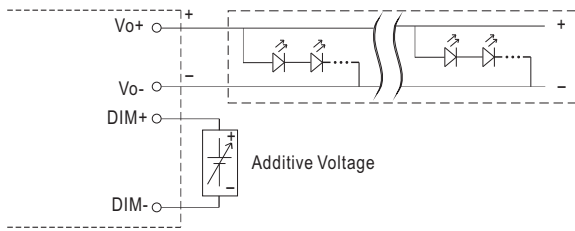

◎ Applying additive 10V PWM signal (frequency range 100Hz ~ 3KHz):

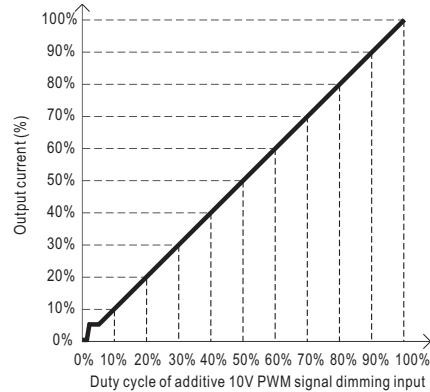
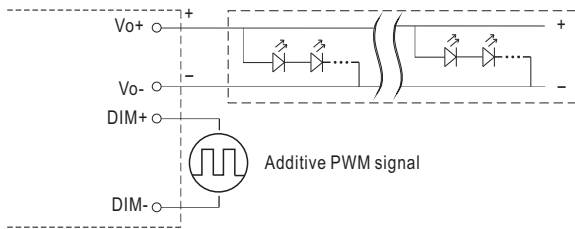

◎ Applying additive resistance:

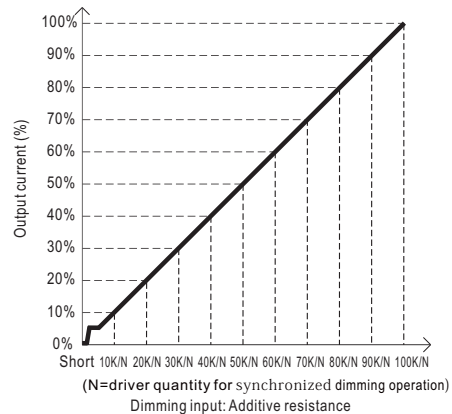
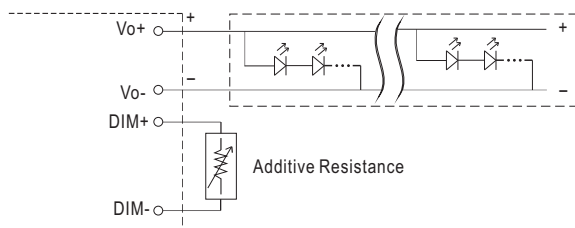

Note : 1. Min. dimming level is about 8% and the output current is not defined when 0% < I_{out} < 8%.
 2. The output current could drop down to 0% when dimming input is about 0kΩ or 0Vdc, or 10V PWM signal with 0% duty cycle.

OUTPUT LOAD vs TEMPERATURE

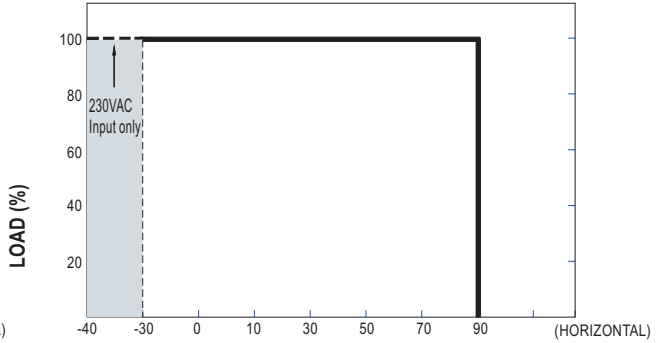
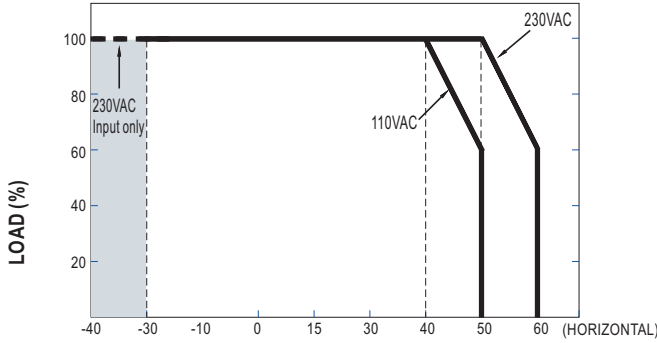

AMBIENT TEMPERATURE, Ta (°C)

Tcase (°C)

- Note: 1. If XLG-240 operates in Constant Power mode with the rated current the maximum workable Ta is 50°C (Typ. 230VAC) or 40°C (Typ. 110VAC)
 2. It may has a soft-start status when operation at -30°C full load and 100VAC input condition.

STATIC CHARACTERISTIC

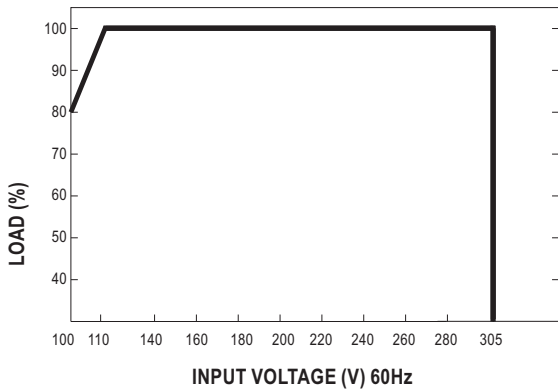

POWER FACTOR (PF) CHARACTERISTIC

※ Tcase at 75°C

Constant Current Mode

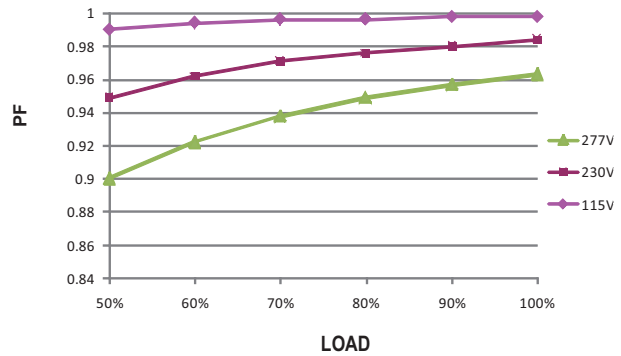

TOTAL HARMONIC DISTORTION (THD)

※ XLG-240-L Model, Tcase at 75°C

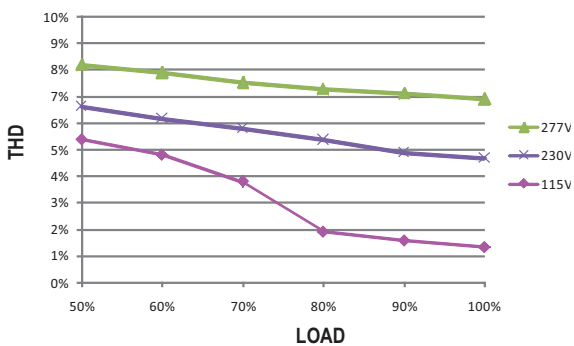

EFFICIENCY vs LOAD

XLG-240 series possess superior working efficiency that up to 93% can be reached in field applications.

※ XLG-240-L Model, Tcase at 75°C

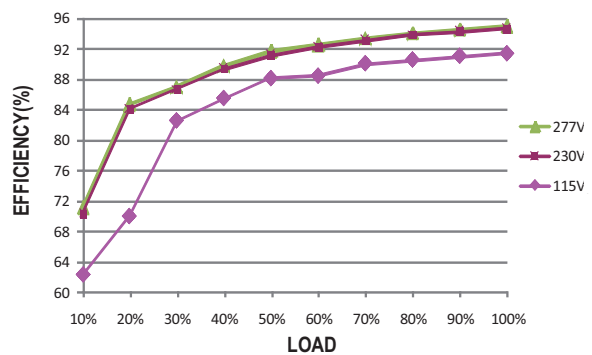

■ LIFE TIME

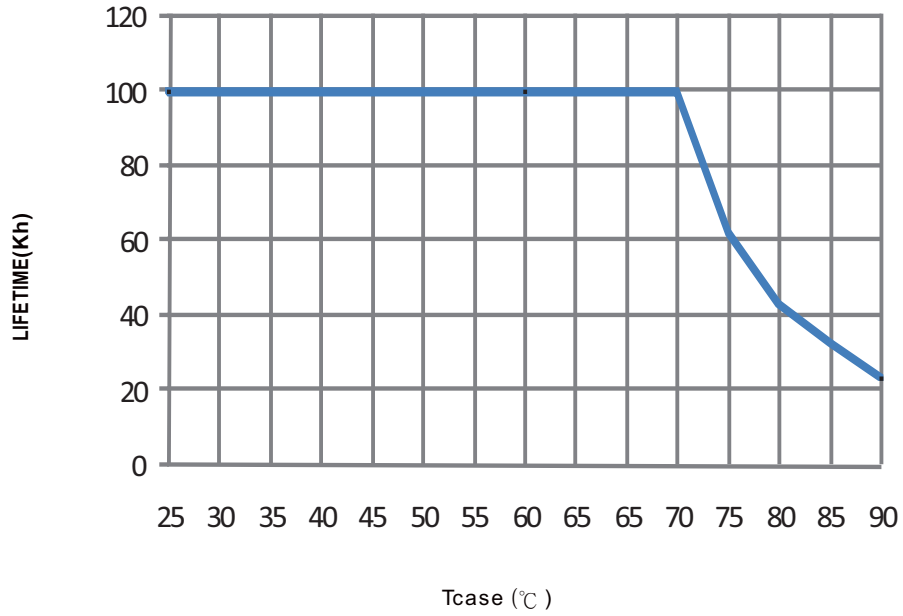

MECHANICAL SPECIFICATION

Case No.:237 Unit:mm

※ **A-Type**

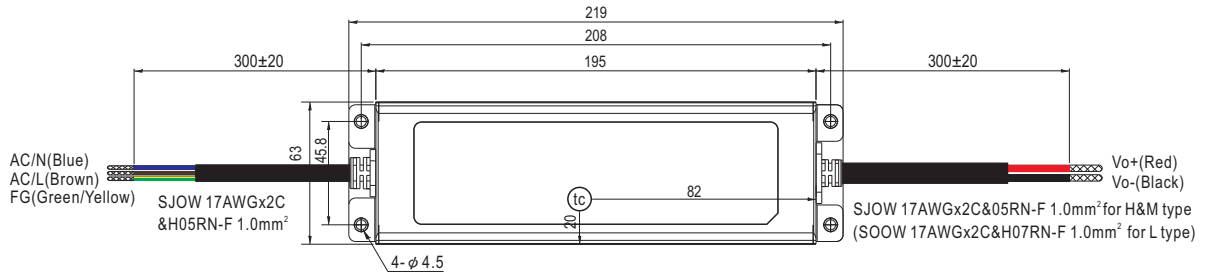

• (tc) : Max. Case Temperature

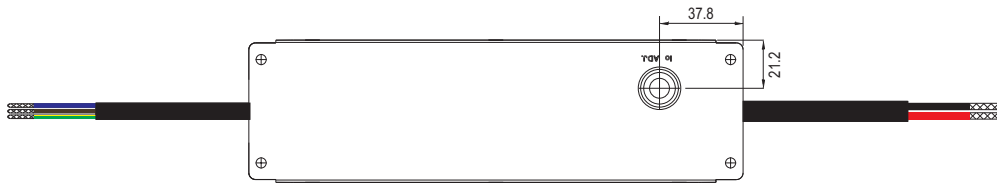

※ **AB-Type**

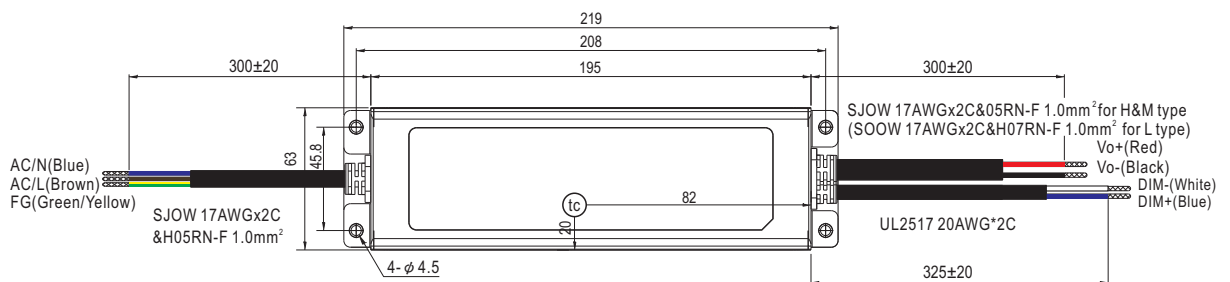

• (tc) : Max. Case Temperature

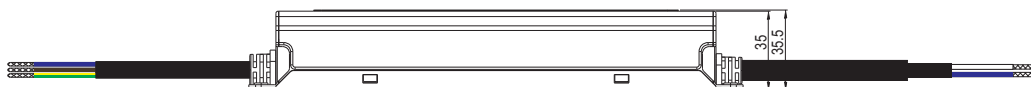

※ Blank-Type

Case No.:237 Unit:mm

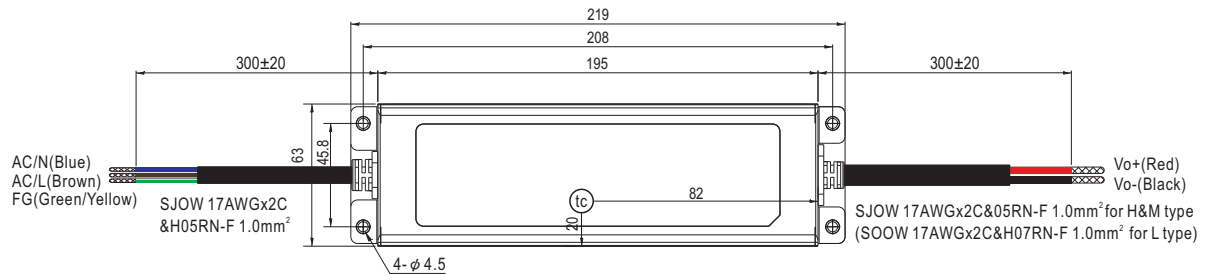

• t_c : Max. Case Temperature



■ **INSTALLATION MANUAL**

Please refer to : <http://www.meanwell.com/manual.html>



Компания «ЭлектроПласт» предлагает заключение долгосрочных отношений при поставках импортных электронных компонентов на взаимовыгодных условиях!

Наши преимущества:

- Оперативные поставки широкого спектра электронных компонентов отечественного и импортного производства напрямую от производителей и с крупнейших мировых складов;
- Поставка более 17-ти миллионов наименований электронных компонентов;
- Поставка сложных, дефицитных, либо снятых с производства позиций;
- Оперативные сроки поставки под заказ (от 5 рабочих дней);
- Экспресс доставка в любую точку России;
- Техническая поддержка проекта, помощь в подборе аналогов, поставка прототипов;
- Система менеджмента качества сертифицирована по Международному стандарту ISO 9001;
- Лицензия ФСБ на осуществление работ с использованием сведений, составляющих государственную тайну;
- Поставка специализированных компонентов (Xilinx, Altera, Analog Devices, Intersil, Interpoint, Microsemi, Aeroflex, Peregrine, Syfer, Eurofarad, Texas Instrument, Miteq, Cobham, E2V, MA-COM, Hittite, Mini-Circuits, General Dynamics и др.);

Помимо этого, одним из направлений компании «ЭлектроПласт» является направление «Источники питания». Мы предлагаем Вам помощь Конструкторского отдела:

- Подбор оптимального решения, техническое обоснование при выборе компонента;
- Подбор аналогов;
- Консультации по применению компонента;
- Поставка образцов и прототипов;
- Техническая поддержка проекта;
- Защита от снятия компонента с производства.



Как с нами связаться

Телефон: 8 (812) 309 58 32 (многоканальный)

Факс: 8 (812) 320-02-42

Электронная почта: org@eplast1.ru

Адрес: 198099, г. Санкт-Петербург, ул. Калинина, дом 2, корпус 4, литера А.