

1SMA59xxBT3G Series, SZ1SMA59xxBT3G Series

1.5 Watt Plastic Surface Mount Zener Voltage Regulators

This complete new line of 1.5 Watt Zener Diodes offers the following advantages.

Features

- Standard Zener Breakdown Voltage Range – 3.3 V to 68 V
- ESD Rating of Class 3 (> 16 kV) per Human Body Model
- Flat Handling Surface for Accurate Placement
- Package Design for Top Slide or Bottom Circuit Board Mounting
- Low Profile Package
- Ideal Replacement for MELF Packages
- AEC-Q101 Qualified and PPAP Capable – SZ1SMA59xxBT3G
- SZ Prefix for Automotive and Other Applications Requiring Unique Site and Control Change Requirements
- Pb-Free Packages are Available*

Mechanical Characteristics:

CASE: Void-free, transfer-molded plastic

FINISH: All external surfaces are corrosion resistant with readily solderable leads

MAXIMUM CASE TEMPERATURE FOR SOLDERING PURPOSES:
260°C for 10 seconds

POLARITY: Cathode indicated by molded polarity notch or cathode band

FLAMMABILITY RATING: UL 94 V-0 @ 0.125 in

MAXIMUM RATINGS

| Rating | Symbol | Value | Unit |
|--|-----------------|----------------|---------------------------|
| DC Power Dissipation @ $T_L = 75^\circ\text{C}$, Measured Zero Lead Length (Note 1) Derate above 75°C | P_D | 1.5 20 | W mW/ $^\circ\text{C}$ |
| Thermal Resistance, Junction-to-Lead | $R_{\theta JL}$ | 50 | $^\circ\text{C}/\text{W}$ |
| DC Power Dissipation @ $T_A = 25^\circ\text{C}$ (Note 2) Derate above 25°C | P_D | 0.5 4.0 | W mW/ $^\circ\text{C}$ |
| Thermal Resistance, Junction-to-Ambient | $R_{\theta JA}$ | 250 | $^\circ\text{C}/\text{W}$ |
| Operating and Storage Temperature Range | T_J, T_{stg} | -65 to +150 | $^\circ\text{C}$ |

Stresses exceeding Maximum Ratings may damage the device. Maximum Ratings are stress ratings only. Functional operation above the Recommended Operating Conditions is not implied. Extended exposure to stresses above the Recommended Operating Conditions may affect device reliability.

1. 1 in square copper pad, FR-4 board.
2. FR-4 Board, using ON Semiconductor minimum recommended footprint.

*For additional information on our Pb-Free strategy and soldering details, please download the ON Semiconductor Soldering and Mounting Techniques Reference Manual, SOLDERRM/D.



ON Semiconductor®

<http://onsemi.com>



SMA
CASE 403D
PLASTIC
STYLE 1

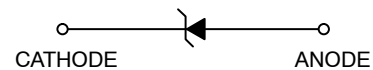

MARKING DIAGRAM

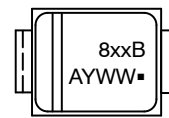

- 8xxB = Device Code (Refer to page 2)
- A = Assembly Location
- Y = Year
- WW = Work Week
- = Pb-Free Package

ORDERING INFORMATION

| Device | Package | Shipping† |
|----------------|------------------|------------------------|
| 1SMA59xxBT3G | SMA (Pb-Free) | 5,000 / Tape & Reel |
| SZ1SMA59xxBT3G | SMA (Pb-Free) | 5,000 / Tape & Reel |

†For information on tape and reel specifications, including part orientation and tape sizes, please refer to our Tape and Reel Packaging Specifications Brochure, BRD8011/D.

DEVICE MARKING INFORMATION

See specific marking information in the device marking column of the Electrical Characteristics table on page 2 of this data sheet.

1SMA59xxBT3G Series, SZ1SMA59xxBT3G Series

ELECTRICAL CHARACTERISTICS ($T_A = 25^\circ\text{C}$ unless otherwise noted, $V_F = 1.5\text{ V Max.}$ @ $I_F = 200\text{ mA}$ for all types)

| Symbol | Parameter |
|----------|------------------------------------|
| V_Z | Reverse Zener Voltage @ I_{ZT} |
| I_{ZT} | Reverse Current |
| Z_{ZT} | Maximum Zener Impedance @ I_{ZT} |
| I_{ZK} | Reverse Current |
| Z_{ZK} | Maximum Zener Impedance @ I_{ZK} |
| I_R | Reverse Leakage Current @ V_R |
| V_R | Reverse Voltage |
| I_F | Forward Current |
| V_F | Forward Voltage @ I_F |
| I_{ZM} | Maximum DC Zener Current |

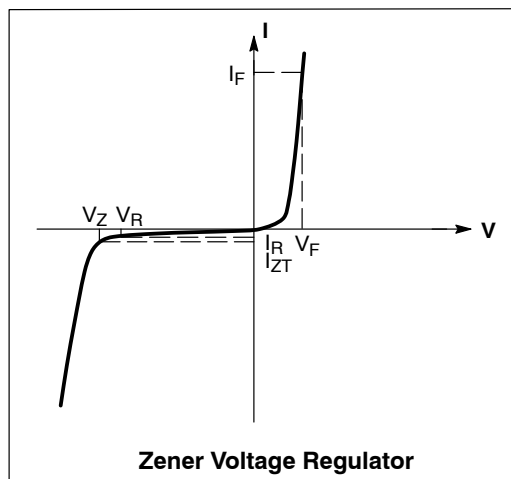

ELECTRICAL CHARACTERISTICS ($T_A = 25^\circ\text{C}$ unless otherwise noted, $V_F = 1.5\text{ V Max.}$ @ $I_F = 200\text{ mA}$ for all types)

| Device* (Note 3) | Device Marking | Zener Voltage (Note 4) | | | | Zener Impedance | | | Leakage Current | | I_{ZM} |
|------------------|----------------|------------------------|-----|-------|------------|---------------------|---------------------|---------------|-----------------|-------|----------|
| | | V_Z (Volts) | | | @ I_{ZT} | Z_{ZT} @ I_{ZT} | Z_{ZK} @ I_{ZK} | I_R @ V_R | | | |
| | | Min | Nom | Max | mA | Ω | Ω | mA | μA | Volts | |
| 1SMA5913BT3G | 813B | 3.13 | 3.3 | 3.47 | 113.6 | 10 | 500 | 1.0 | 50 | 1.0 | 455 |
| 1SMA5914BT3G | 814B | 3.42 | 3.6 | 3.78 | 104.2 | 9.0 | 500 | 1.0 | 35.5 | 1.0 | 417 |
| 1SMA5915BT3G | 815B | 3.70 | 3.9 | 4.10 | 96.1 | 7.5 | 500 | 1.0 | 12.5 | 1.0 | 385 |
| 1SMA5916BT3G | 816B | 4.08 | 4.3 | 4.52 | 87.2 | 6.0 | 500 | 1.0 | 2.5 | 1.0 | 349 |
| 1SMA5917BT3G | 817B | 4.46 | 4.7 | 4.94 | 79.8 | 5.0 | 500 | 1.0 | 2.5 | 1.5 | 319 |
| 1SMA5918BT3G | 818B | 4.84 | 5.1 | 5.36 | 73.5 | 4.0 | 350 | 1.0 | 2.5 | 2.0 | 294 |
| 1SMA5919BT3G | 819B | 5.32 | 5.6 | 5.88 | 66.9 | 2.0 | 250 | 1.0 | 2.5 | 3.0 | 268 |
| 1SMA5920BT3G | 820B | 5.89 | 6.2 | 6.51 | 60.5 | 2.0 | 200 | 1.0 | 2.5 | 4.0 | 242 |
| 1SMA5921BT3G | 821B | 6.46 | 6.8 | 7.14 | 55.1 | 2.5 | 200 | 1.0 | 2.5 | 5.2 | 221 |
| 1SMA5922BT3G | 822B | 7.12 | 7.5 | 7.88 | 50 | 3.0 | 400 | 0.5 | 2.5 | 6.0 | 200 |
| 1SMA5923BT3G | 823B | 7.79 | 8.2 | 8.61 | 45.7 | 3.5 | 400 | 0.5 | 2.5 | 6.5 | 183 |
| 1SMA5924BT3G | 824B | 8.64 | 9.1 | 9.56 | 41.2 | 4.0 | 500 | 0.5 | 2.5 | 7.0 | 165 |
| 1SMA5925BT3G | 825B | 9.5 | 10 | 10.5 | 37.5 | 4.5 | 500 | 0.25 | 2.5 | 8.0 | 150 |
| 1SMA5926BT3G | 826B | 10.45 | 11 | 11.55 | 34.1 | 5.5 | 550 | 0.25 | 0.5 | 8.4 | 136 |
| 1SMA5927BT3G | 827B | 11.4 | 12 | 12.6 | 31.2 | 6.5 | 550 | 0.25 | 0.5 | 9.1 | 125 |
| 1SMA5928BT3G | 828B | 12.35 | 13 | 13.65 | 28.8 | 7.0 | 550 | 0.25 | 0.5 | 9.9 | 115 |
| 1SMA5929BT3G | 829B | 14.25 | 15 | 15.75 | 25 | 9.0 | 600 | 0.25 | 0.5 | 11.4 | 100 |
| 1SMA5930BT3G | 830B | 15.2 | 16 | 16.8 | 23.4 | 10 | 600 | 0.25 | 0.5 | 12.2 | 94 |
| 1SMA5931BT3G | 831B | 17.1 | 18 | 18.9 | 20.8 | 12 | 650 | 0.25 | 0.5 | 13.7 | 83 |
| 1SMA5932BT3G | 832B | 19 | 20 | 21 | 18.7 | 14 | 650 | 0.25 | 0.5 | 15.2 | 75 |
| 1SMA5933BT3G | 833B | 20.9 | 22 | 23.1 | 17 | 17.5 | 650 | 0.25 | 0.5 | 16.7 | 68 |
| 1SMA5934BT3G | 834B | 22.8 | 24 | 25.2 | 15.6 | 19 | 700 | 0.25 | 0.5 | 18.2 | 63 |
| 1SMA5935BT3G | 835B | 25.65 | 27 | 28.35 | 13.9 | 23 | 700 | 0.25 | 0.5 | 20.6 | 56 |
| 1SMA5936BT3G | 836B | 28.5 | 30 | 31.5 | 12.5 | 26 | 750 | 0.25 | 0.5 | 22.8 | 50 |
| 1SMA5937BT3G | 837B | 31.35 | 33 | 34.65 | 11.4 | 33 | 800 | 0.25 | 0.5 | 25.1 | 45 |
| 1SMA5938BT3G | 838B | 34.2 | 36 | 37.8 | 10.4 | 38 | 850 | 0.25 | 0.5 | 27.4 | 42 |
| 1SMA5939BT3G | 839B | 37.05 | 39 | 40.95 | 9.6 | 45 | 900 | 0.25 | 0.5 | 29.7 | 38 |
| 1SMA5940BT3G | 840B | 40.85 | 43 | 45.15 | 8.7 | 53 | 950 | 0.25 | 0.5 | 32.7 | 35 |
| 1SMA5941BT3G | 841B | 44.65 | 47 | 49.35 | 8.0 | 67 | 1000 | 0.25 | 0.5 | 35.8 | 32 |
| 1SMA5942BT3G | 842B | 48.45 | 51 | 53.55 | 7.3 | 70 | 1100 | 0.25 | 0.5 | 38.8 | 29 |
| 1SMA5943BT3G | 843B | 53.2 | 56 | 58.8 | 6.7 | 86 | 1300 | 0.25 | 0.5 | 42.6 | 27 |
| 1SMA5944BT3G | 844B | 58.9 | 62 | 65.1 | 6.0 | 100 | 1500 | 0.25 | 0.5 | 47.1 | 24 |
| 1SMA5945BT3G | 845B | 64.6 | 68 | 71.4 | 5.5 | 120 | 1700 | 0.25 | 0.5 | 51.7 | 22 |

3. Tolerance and Voltage Regulation Designation – The type number listed indicates a tolerance of $\pm 5\%$.

4. V_Z limits are to be guaranteed at thermal equilibrium.

* Include SZ-prefix devices where applicable.

1SMA59xxBT3G Series, SZ1SMA59xxBT3G Series

RATING AND TYPICAL CHARACTERISTIC CURVES ($T_A = 25^\circ\text{C}$)

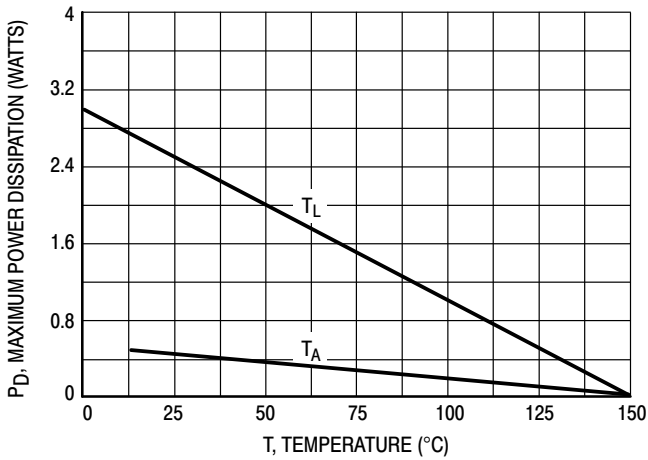

Figure 1. Steady State Power Derating

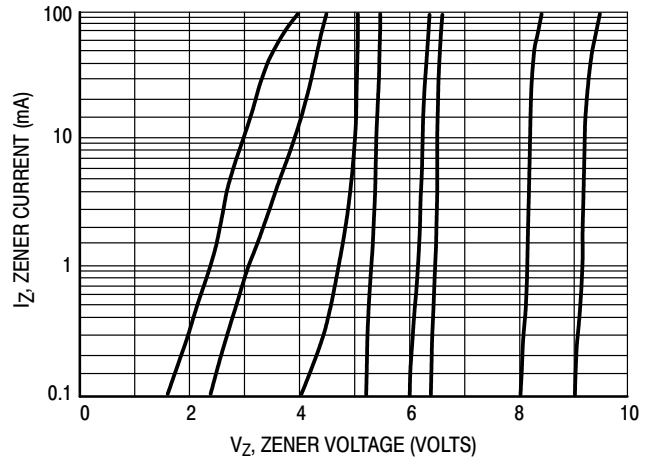

Figure 2. V_Z - 3.3 thru 10 Volts

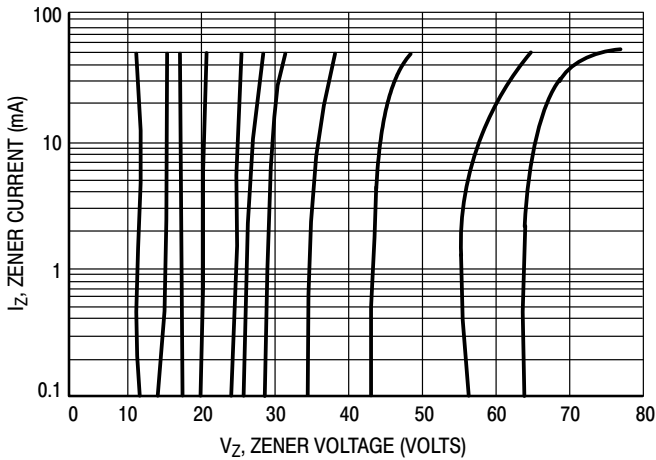

Figure 3. $V_Z = 12$ thru 68 Volts

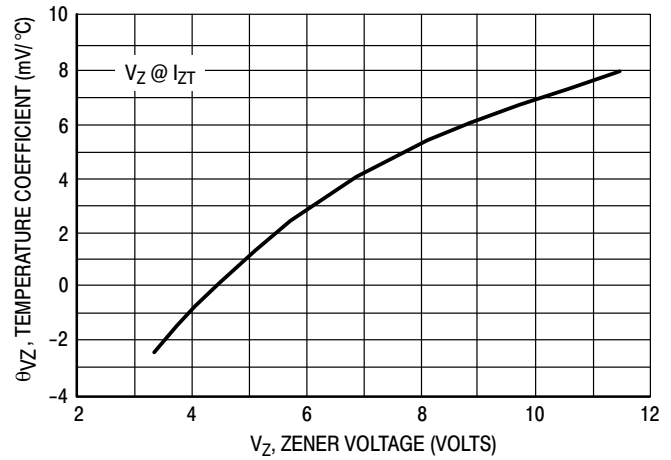

Figure 4. Zener Voltage - 3.3 to 12 Volts

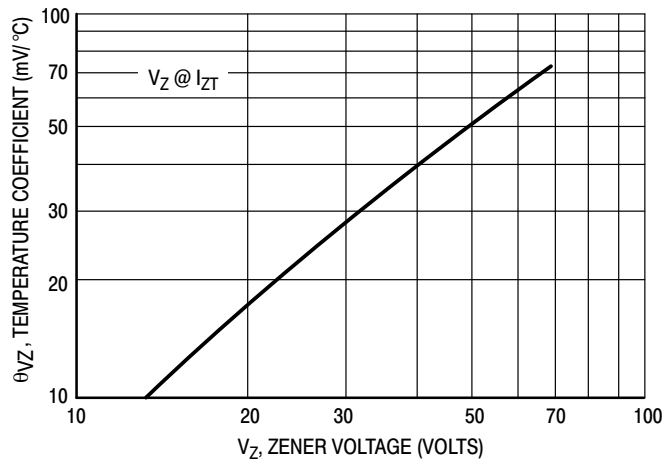

Figure 5. Zener Voltage - 12 to 68 Volts

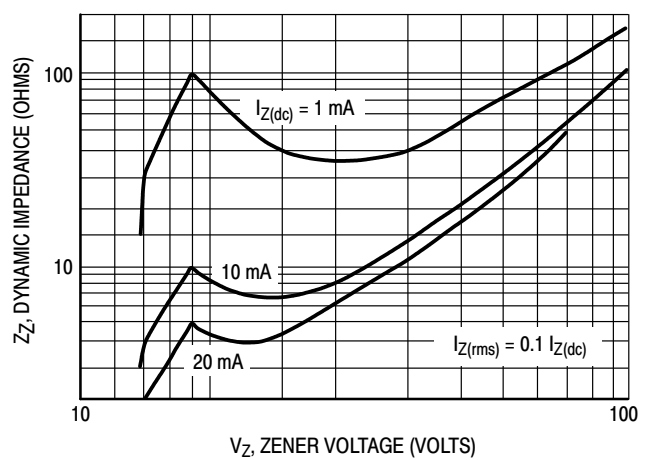

Figure 6. Effect of Zener Voltage

1SMA59xxBT3G Series, SZ1SMA59xxBT3G Series

RATING AND TYPICAL CHARACTERISTIC CURVES ($T_A = 25^\circ\text{C}$)

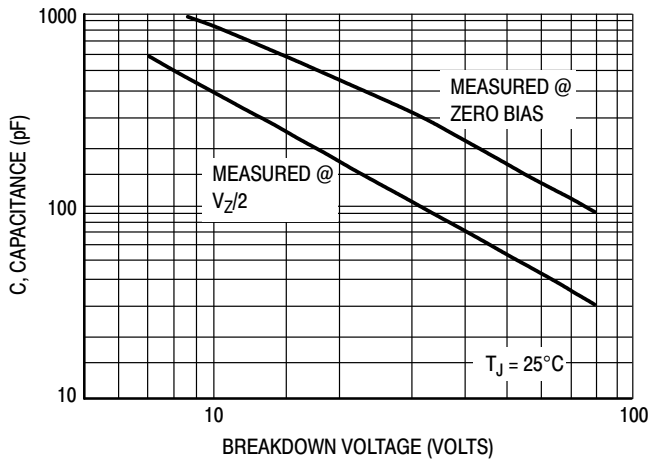

Figure 7. Capacitance Curve

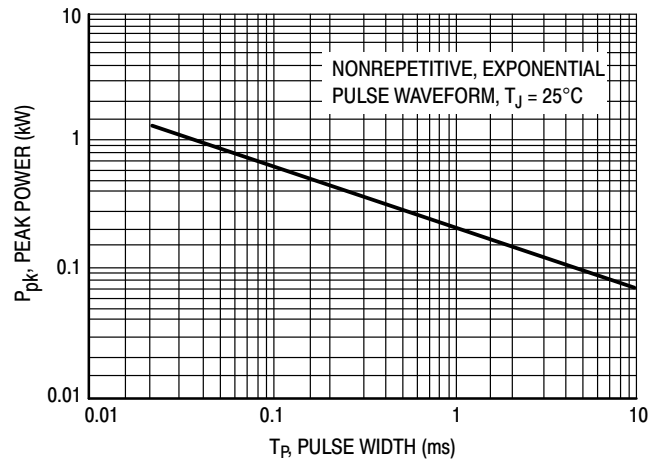

Figure 8. Typical Pulse Rating Curve

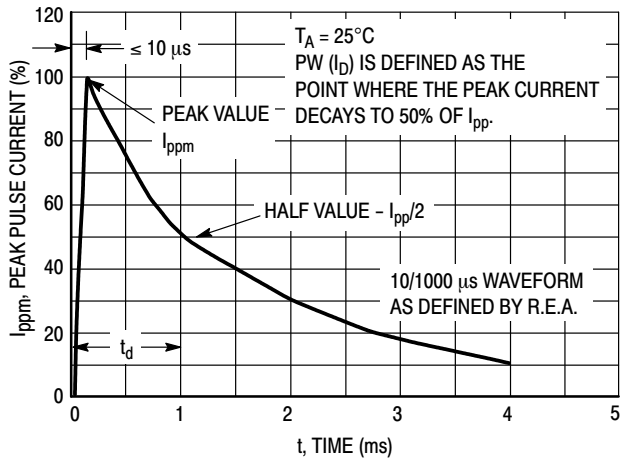

Figure 9. Pulse Waveform

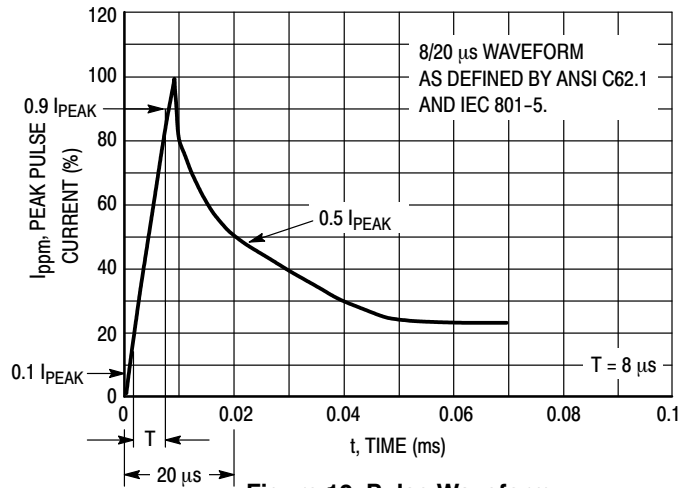
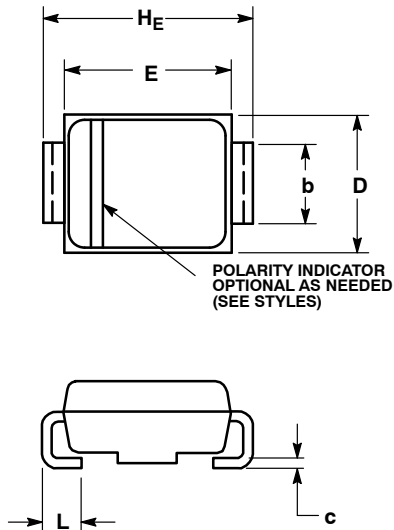

Figure 10. Pulse Waveform

1SMA59xxBT3G Series, SZ1SMA59xxBT3G Series

PACKAGE DIMENSIONS

SMA CASE 403D-02 ISSUE F



- NOTES:
1. DIMENSIONING AND TOLERANCING PER ANSI Y14.5M, 1982.
 2. CONTROLLING DIMENSION: INCH.
 3. 403D-01 OBSOLETE, NEW STANDARD IS 403D-02.

| DIM | MILLIMETERS | | | INCHES | | |
|-----|-------------|------|------|--------|-------|-------|
| | MIN | NOM | MAX | MIN | NOM | MAX |
| A | 1.97 | 2.10 | 2.20 | 0.078 | 0.083 | 0.087 |
| A1 | 0.05 | 0.10 | 0.15 | 0.002 | 0.004 | 0.006 |
| b | 1.27 | 1.45 | 1.63 | 0.050 | 0.057 | 0.064 |
| c | 0.15 | 0.28 | 0.41 | 0.006 | 0.011 | 0.016 |
| D | 2.29 | 2.60 | 2.92 | 0.090 | 0.103 | 0.115 |
| E | 4.06 | 4.32 | 4.57 | 0.160 | 0.170 | 0.180 |
| HE | 4.83 | 5.21 | 5.59 | 0.190 | 0.205 | 0.220 |
| L | 0.76 | 1.14 | 1.52 | 0.030 | 0.045 | 0.060 |

- STYLE 1:
PIN 1. CATHODE (POLARITY BAND)
2. ANODE

SOLDERING FOOTPRINT*

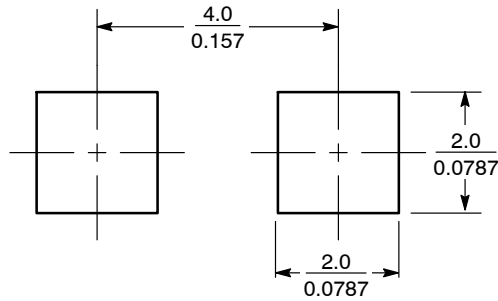

SCALE 8:1 ($\frac{\text{mm}}{\text{inches}}$)

*For additional information on our Pb-Free strategy and soldering details, please download the ON Semiconductor Soldering and Mounting Techniques Reference Manual, SOLDERRM/D.

ON Semiconductor and are registered trademarks of Semiconductor Components Industries, LLC (SCILLC). SCILLC reserves the right to make changes without further notice to any products herein. SCILLC makes no warranty, representation or guarantee regarding the suitability of its products for any particular purpose, nor does SCILLC assume any liability arising out of the application or use of any product or circuit, and specifically disclaims any and all liability, including without limitation special, consequential or incidental damages. "Typical" parameters which may be provided in SCILLC data sheets and/or specifications can and do vary in different applications and actual performance may vary over time. All operating parameters, including "Typicals" must be validated for each customer application by customer's technical experts. SCILLC does not convey any license under its patent rights nor the rights of others. SCILLC products are not designed, intended, or authorized for use as components in systems intended for surgical implant into the body, or other applications intended to support or sustain life, or for any other application in which the failure of the SCILLC product could create a situation where personal injury or death may occur. Should Buyer purchase or use SCILLC products for any such unintended or unauthorized application, Buyer shall indemnify and hold SCILLC and its officers, employees, subsidiaries, affiliates, and distributors harmless against all claims, costs, damages, and expenses, and reasonable attorney fees arising out of, directly or indirectly, any claim of personal injury or death associated with such unintended or unauthorized use, even if such claim alleges that SCILLC was negligent regarding the design or manufacture of the part. SCILLC is an Equal Opportunity/Affirmative Action Employer. This literature is subject to all applicable copyright laws and is not for resale in any manner.

PUBLICATION ORDERING INFORMATION

LITERATURE FULFILLMENT:
Literature Distribution Center for ON Semiconductor
P.O. Box 5163, Denver, Colorado 80217 USA
Phone: 303-675-2175 or 800-344-3860 Toll Free USA/Canada
Fax: 303-675-2176 or 800-344-3867 Toll Free USA/Canada
Email: orderlit@onsemi.com

N. American Technical Support: 800-282-9855 Toll Free USA/Canada
Europe, Middle East and Africa Technical Support:
Phone: 421 33 790 2910
Japan Customer Focus Center
Phone: 81-3-5817-1050

ON Semiconductor Website: www.onsemi.com
Order Literature: <http://www.onsemi.com/orderlit>
For additional information, please contact your local Sales Representative



Компания «ЭлектроПласт» предлагает заключение долгосрочных отношений при поставках импортных электронных компонентов на взаимовыгодных условиях!

Наши преимущества:

- Оперативные поставки широкого спектра электронных компонентов отечественного и импортного производства напрямую от производителей и с крупнейших мировых складов;
- Поставка более 17-ти миллионов наименований электронных компонентов;
- Поставка сложных, дефицитных, либо снятых с производства позиций;
- Оперативные сроки поставки под заказ (от 5 рабочих дней);
- Экспресс доставка в любую точку России;
- Техническая поддержка проекта, помощь в подборе аналогов, поставка прототипов;
- Система менеджмента качества сертифицирована по Международному стандарту ISO 9001;
- Лицензия ФСБ на осуществление работ с использованием сведений, составляющих государственную тайну;
- Поставка специализированных компонентов (Xilinx, Altera, Analog Devices, Intersil, Interpoint, Microsemi, Aeroflex, Peregrine, Syfer, Eurofarad, Texas Instrument, Miteq, Cobham, E2V, MA-COM, Hittite, Mini-Circuits, General Dynamics и др.);

Помимо этого, одним из направлений компании «ЭлектроПласт» является направление «Источники питания». Мы предлагаем Вам помощь Конструкторского отдела:

- Подбор оптимального решения, техническое обоснование при выборе компонента;
- Подбор аналогов;
- Консультации по применению компонента;
- Поставка образцов и прототипов;
- Техническая поддержка проекта;
- Защита от снятия компонента с производства.



Как с нами связаться

Телефон: 8 (812) 309 58 32 (многоканальный)

Факс: 8 (812) 320-02-42

Электронная почта: org@eplast1.ru

Адрес: 198099, г. Санкт-Петербург, ул. Калинина, дом 2, корпус 4, литера А.