

# Large Size Ferrite Cores for High Power

T/UU/UI/EC/EIC/EE/EI/DT/PQ/SP series

Issue date: January 2013

- All specifications are subject to change without notice.
  - Conformity to RoHS Directive: This means that, in conformity with EU Directive 2002/95/EC, lead, cadmium, mercury, hexavalent chromium, and specific bromine-based flame retardants, PBB and PBDE, have not been used, except for exempted applications.
-

# Large Size Ferrite Cores for High Power

## T Series

### T CORE

#### CORE SHAPES AND DIMENSIONS/CHARACTERISTICS



#### PRODUCT IDENTIFICATION

PE22 T 51 × 13 × 31  
 (1) (2) (3) (4) (5)

- (1) Material name
- (2) Shape
- (3) Dimension A
- (4) Dimension C
- (5) Dimension B

| Part No.        | AL*(nH/N <sup>2</sup> )<br>±25% | Dimensions (mm) |          |           | Core factor                        |  | A <sub>e</sub> (mm <sup>2</sup> ) | ℓ <sub>e</sub> (mm) | V <sub>e</sub> (mm <sup>3</sup> ) | Weight<br>(g) |
|-----------------|---------------------------------|-----------------|----------|-----------|------------------------------------|--|-----------------------------------|---------------------|-----------------------------------|---------------|
|                 |                                 | øA              | øB       | C         | C <sub>1</sub> (mm <sup>-1</sup> ) | C <sub>2</sub> ×10 <sup>-2</sup> (mm <sup>-3</sup> ) |                                   |                     |                                   |               |
| PE22 T51×13×31  | 2330                            |                 |          |           |                                    |  |                                   |                     |                                   | 80            |
| PC40 T51×13×31  | 2980                            | 51.0±1.0        | 31.0±0.6 | 13.0±0.5  | 0.97084                            | 0.76235  | 127                               | 124                 | 15740                             | 80            |
| PE90 T51×13×31  | 2850                            |                 |          |           |                                    |  |                                   |                     |                                   | 82            |
| PE22 T62×13×39  | 2290                            |                 |          |           |                                    |  |                                   |                     |                                   | 121           |
| PC40 T62×13×39  | 2930                            | 62.5±1.2        | 39.0±0.8 | 13.5±0.5  | 0.98689                            | 0.63377  | 156                               | 154                 | 23930                             | 121           |
| PE90 T62×13×39  | 2800                            |                 |          |           |                                    |  |                                   |                     |                                   | 124           |
| PE22 T72×20×48  | 2920                            |                 |          |           |                                    |  |                                   |                     |                                   | 217           |
| PC40 T72×20×48  | 3730                            | 72.0±1.5        | 48.0±0.9 | 20.0±0.5  | 0.77481                            | 0.32729  | 237                               | 183                 | 43420                             | 217           |
| PE90 T72×20×48  | 3570                            |                 |          |           |                                    |  |                                   |                     |                                   | 222           |
| PE22 T80×20×50  | 3380                            |                 |          |           |                                    |  |                                   |                     |                                   | 294           |
| PC40 T80×20×50  | 4320                            | 80.0±1.6        | 50.0±1.0 | 20.0±0.5  | 0.66842                            | 0.22694  | 295                               | 197                 | 57990                             | 294           |
| PE90 T80×20×50  | 4140                            |                 |          |           |                                    |  |                                   |                     |                                   | 300           |
| PE22 T96×20×70  | 2270                            |                 |          |           |                                    |  |                                   |                     |                                   | 325           |
| PC40 T96×20×70  | 2910                            | 96.0±1.9        | 70.0±1.4 | 20.0 ±0.5 | 0.99464                            | 0.38574  | 258                               | 256                 | 66130                             | 325           |
| PE90 T96×20×70  | 2780                            |                 |          |           |                                    |  |                                   |                     |                                   | 332           |
| PE22 T104×20×80 | 1890                            |                 |          |           |                                    |  |                                   |                     |                                   | 333           |
| PC40 T104×20×80 | 2410                            | 104.0±2.1       | 80.0±1.6 | 20.0±0.5  | 1.19742                            | 0.50179  | 239                               | 286                 | 68180                             | 333           |
| PE90 T104×20×80 | 2310                            |                 |          |           |                                    |  |                                   |                     |                                   | 340           |

\* Measuring condition: T=23°C, f=1kHz, H<sub>m</sub>=0.4A/m

## UU Series

### UU CORE

#### CORE SHAPES AND DIMENSIONS/CHARACTERISTICS



#### PRODUCT IDENTIFICATION

PE22 UU 79 × 129 × 31  
 (1) (2) (3) (4) (5)

- (1) Material name  
 (2) Shape  
 (3) Dimension A  
 (4) Dimension 2B  
 (5) Dimension C

| Part No.           | Al*(nH/N <sup>2</sup> )<br>±25% | Dimensions (mm) |           |          |          |           |          |                |                |                        |
|--------------------|---------------------------------|-----------------|-----------|----------|----------|-----------|----------|----------------|----------------|------------------------|
|                    |                                 | A               | 2B        | C        | E        | 2F        | H        | R <sub>1</sub> | R <sub>2</sub> | E×2F(mm <sup>2</sup> ) |
| PE22 UU79×129×31   | 4790                            |                 |           |          |          |           |          |                |                |                        |
| PC40 UU79×129×31   | 6030                            | 79.0±2.5        | 129.0±2.5 | 31.5±1.0 | 34.0min. | 85.0±1.5  | 22.0±1.0 | 5              | 22             | 2980                   |
| PE90 UU79×129×31   | 5768                            |                 |           |          |          |           |          |                |                |                        |
| PE22 UU100×151×30  | 5540                            |                 |           |          |          |           |          |                |                |                        |
| PC40 UU100×151×30  | 6990                            | 100.0±3.0       | 151.0±2.5 | 30.0±1.0 | 39.0min. | 90.0±1.5  | 30.0±1.5 | 5              | 30             | 3600                   |
| PE90 UU100×151×30  | 6686                            |                 |           |          |          |           |          |                |                |                        |
| PE22 UU100×160×20  | 3460                            |                 |           |          |          |           |          |                |                |                        |
| PC40 UU100×160×20  | 4360                            | 100.0±3.0       | 160.0±2.5 | 20.0±1.0 | 39.0min. | 100.0±1.5 | 30.0±1.5 | 5              | 35             | 4000                   |
| PE90 UU100×160×20  | 4170                            |                 |           |          |          |           |          |                |                |                        |
| PE22 UU101×115×25  | 4480                            |                 |           |          |          |           |          |                |                |                        |
| PC40 UU101×115×25  | 5640                            | 101.0±3.0       | 115.0±2.5 | 25.4±1.0 | 50.0min. | 64.0±1.5  | 25.0±1.0 | 5              | 25             | 3260                   |
| PE90 UU101×115×25  | 5395                            |                 |           |          |          |           |          |                |                |                        |
| PE22 UU120×160×20  | 3140                            |                 |           |          |          |           |          |                |                |                        |
| PC40 UU120×160×20  | 3960                            | 120.0±3.0       | 160.0±2.5 | 20.0±1.0 | 59.0min. | 100.0±1.5 | 30.0±1.5 | 5              | 35             | 6000                   |
| PE90 UU120×160×20  | 3788                            |                 |           |          |          |           |          |                |                |                        |
| PE22 UU80×150×30N  | 3570                            |                 |           |          |          |           |          |                |                |                        |
| PC40 UU80×150×30N  | 4500                            | 80.0±2.5        | 150.0±2.5 | 30.0±1.0 | 39.0min. | 110.0±1.5 | 20.0±1.0 | 1              | 0              | 4400                   |
| PE90 UU80×150×30N  | 4304                            |                 |           |          |          |           |          |                |                |                        |
| PE22 UU100×151×30N | 5470                            |                 |           |          |          |           |          |                |                |                        |
| PC40 UU100×151×30N | 6900                            | 100.0±3.0       | 151.0±2.5 | 30.0±1.0 | 39.0min. | 90.0±1.5  | 30.0±1.5 | 1              | 1              | 3600                   |
| PE90 UU100×151×30N | 6600                            |                 |           |          |          |           |          |                |                |                        |
| PE22 UU101×114×25N | 4425                            |                 |           |          |          |           |          |                |                |                        |
| PC40 UU101×114×25N | 5570                            | 101.2±3.0       | 114.0±2.5 | 25.4±1.0 | 49.5min. | 63.8±1.5  | 25.1±1.0 | 0              | 0              | 3254                   |
| PE90 UU101×114×25N | 5328                            |                 |           |          |          |           |          |                |                |                        |

\* Measuring condition: T=23°C, f=1kHz, H<sub>m</sub>=0.4A/m

| Part No.           | Core factor           |                                      |                    |                  |                    | Weight(g) |
|--------------------|-----------------------|--------------------------------------|--------------------|------------------|--------------------|-----------|
|                    | $C_1(\text{mm}^{-1})$ | $C_2 \times 10^{-2}(\text{mm}^{-3})$ | $A_e(\text{mm}^2)$ | $l_e(\text{mm})$ | $V_e(\text{mm}^3)$ |           |
| PE22 UU79×129×31   | 0.44605               | 0.06437                              | 693                | 309              | 214220             | 1080      |
| PC40 UU79×129×31   |                       |                                      |                    |                  |                    | 1080      |
| PE90 UU79×129×31   |                       |                                      |                    |                  |                    | 1103      |
| PE22 UU100×151×30  | 0.38801               | 0.04241                              | 915                | 355              | 324860             | 1630      |
| PC40 UU100×151×30  |                       |                                      |                    |                  |                    | 1630      |
| PE90 UU100×151×30  |                       |                                      |                    |                  |                    | 1664      |
| PE22 UU100×160×20  | 0.62375               | 0.10396                              | 600                | 374              | 224550             | 1130      |
| PC40 UU100×160×20  |                       |                                      |                    |                  |                    | 1130      |
| PE90 UU100×160×20  |                       |                                      |                    |                  |                    | 1154      |
| PE22 UU101×115×25  | 0.47757               | 0.07373                              | 648                | 309              | 200350             | 1000      |
| PC40 UU101×115×25  |                       |                                      |                    |                  |                    | 1000      |
| PE90 UU101×115×25  |                       |                                      |                    |                  |                    | 1021      |
| PE22 UU120×160×20  | 0.69041               | 0.11507                              | 600                | 414              | 248550             | 1240      |
| PC40 UU120×160×20  |                       |                                      |                    |                  |                    | 1240      |
| PE90 UU120×160×20  |                       |                                      |                    |                  |                    | 1266      |
| PE22 UU80×150×30N  | 0.60472               | 0.00101                              | 600                | 363              | 217700             | 1095      |
| PC40 UU80×150×30N  |                       |                                      |                    |                  |                    | 1095      |
| PE90 UU80×150×30N  |                       |                                      |                    |                  |                    | 1118      |
| PE22 UU100×151×30N | 0.39361               | 0.04373                              | 900                | 354              | 318820             | 1642      |
| PC40 UU100×151×30N |                       |                                      |                    |                  |                    | 1642      |
| PE90 UU100×151×30N |                       |                                      |                    |                  |                    | 1676      |
| PE22 UU101×114×25N | 0.48382               | 0.07589                              | 638                | 308              | 196650             | 1013      |
| PC40 UU101×114×25N |                       |                                      |                    |                  |                    | 1013      |
| PE90 UU101×114×25N |                       |                                      |                    |                  |                    | 1034      |

## UU CORE BAND

### BAND SHAPES AND DIMENSIONS/CHARACTERISTICS

#### AH-type band



Band is optional parts.  
AH-type is the band with a board.

#### B-type band



Band is optional parts.  
B-type is the band without a board.



AH type

B type

| Part No.      | Dimensions (mm) |      |     |      |     |   |    |    |     |     |  |
|---------------|-----------------|------|-----|------|-----|---|----|----|-----|-----|--|
|               | A               | B    | C   | D    | E   | G | H1 | H2 | J   | t   |  |
| FHH 79×129AH  | 370             | 27   | 180 | 31.5 | 1.5 | 7 | 14 | 7  | 160 | 0.2 |  |
| FHH 79×129B   | 370             | 27   | —   | —    | —   | — | —  | —  | —   | 0.3 |  |
| FHH 100×151AH | 435             | 27   | 190 | 31.5 | 1.5 | 7 | 14 | 7  | 170 | 0.3 |  |
| FHH 100×151B  | 435             | 30   | —   | —    | —   | — | —  | —  | —   | 0.3 |  |
| FHH 100×160AH | 447             | 18   | 206 | 23.0 | 1.5 | 7 | 14 | 7  | 186 | 0.3 |  |
| FHH 100×160B  | 447             | 18   | —   | —    | —   | — | —  | —  | —   | 0.3 |  |
| FHH 101×115AH | 380             | 23.4 | 160 | 28.0 | 1.5 | 7 | 14 | 7  | 140 | 0.3 |  |
| FHH 101×115B  | 378             | 23.4 | —   | —    | —   | — | —  | —  | —   | 0.3 |  |
| FHH 120×160AH | 482             | 18   | 206 | 23.0 | 1.5 | 7 | 14 | 7  | 186 | 0.3 |  |
| FHH 120×160B  | 482             | 18   | —   | —    | —   | — | —  | —  | —   | 0.3 |  |

## HANDLING INSTRUCTIONS OF UU CORE BAND

When using this product, read and follow the handling instructions below carefully to ensure the safety of the products that you design.

### ASSEMBLING

- Certain parts of the ferrite core tightening band (hereinafter referred to as the "band") can be sharp. Be careful when handling these parts.  
Use protective equipment such as gloves if necessary.
- When putting a band and ferrite core together, make sure that the ferrite core matches the band's size, and set the ferrite core in the correct position.
- To tighten the band, use a cross point screwdriver of the correct size equipped with a torque reading mechanism.
- The torque for tightening the band must be determined and controlled according to the band's strength, the ferrite core's size, and the usage environment.
- Take special care not to overtighten the band as this could damage the ferrite core and/or the band.
- Conversely, if the tightening torque is too low, you will not be able to secure the ferrite core properly. Take special care to avoid this as this can cause the ferrite core to become displaced, fall off, drop, or affect the ferrite core's characteristics.

### USAGE ENVIRONMENT

- Depending on the usage environment, the band may become damaged or its strength may be compromised, reducing the strength at which it can secure the ferrite core.  
When using the band, make sure that it is resistant to the intended usage environment.
- The band is constructed in such a way that it can become extended or damaged when subjected to shocks, excessive loads, vibrations, temperature variations, or high and low temperatures, causing the ferrite core to become displaced, fall off, or drop.  
Make sure that the strength of the band itself and the strength at which it secures the ferrite core can be maintained in the intended usage environment.
- The band is made of metal, which means it can be affected by water, chemicals and other elements, which may in turn lead to corrosion.  
When using the band, make sure that it is resistant to the intended usage environment.

### OTHER PRECAUTIONS

- The band is essentially a thin metal plate. Take special care to avoid accidents because its ends can behave like the tip of a whip.  
Persons handling the band must take special care to protect themselves as well as others from getting injured.
- Never re-work the band or replace any parts becomes such actions can compromise the band's strength and lead to problems.
- Do not reuse a band that you have used once before as it may not have sufficient strength.
- Do not use the bands for purposes other than to secure ferrite cores.  
The bands are not edible. Keep them out of the reach of children.

**UU79X129X31**



**Parameter**

|                                |                     |                  |         |
|--------------------------------|---------------------|------------------|---------|
| Core constant                  | C1                  | mm <sup>-1</sup> | 0.44605 |
|                                | C2×10 <sup>-2</sup> | mm <sup>-3</sup> | 0.06437 |
| Effective magnetic path length | ℓ <sub>e</sub>      | mm               | 309     |
| Effective cross-sectional area | A <sub>e</sub>      | mm <sup>2</sup>  | 693     |
| Effective core volume          | V <sub>e</sub>      | mm <sup>3</sup>  | 214220  |
| Minimum cross-sectional area   | A <sub>min.*</sub>  | mm <sup>2</sup>  | 693LB*  |
| Winding cross-sectional area   | A <sub>cw</sub>     | mm <sup>2</sup>  | 2980    |
| Weight(approx.)                |                     | g                | 1080    |

\* The symbol followed A min. value shows minimum cross-sectional area part. L is outer pole part, B is the back part.

|                  |                               |
|------------------|-------------------------------|
| Part No.         | AL-value*(nH/N <sup>2</sup> ) |
| PE22 UU79X129X31 | 4790±25%                      |
| PC40 UU79X129X31 | 6030±25%                      |

\* AL-value: T=23°C, f=1kHz, H<sub>m</sub>=0.4A/m

**NI limit vs. AL-value for PE22 UU79X129X31**



When applied magnetic field providing NI to a setting core for arbitrary AL-value, show each NI value when decreased 20% and 40% from initial AL-value.

**AL-value vs. Air gap length for PE22 UU79X129X31**

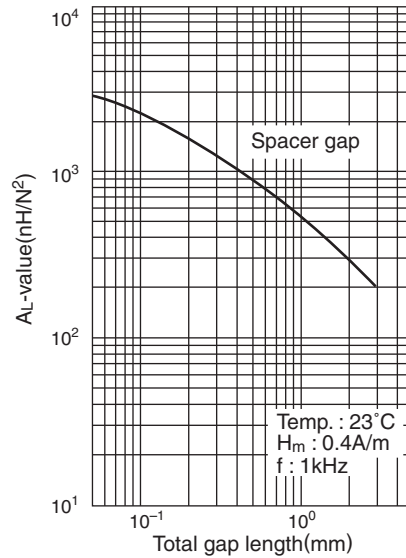

**NI limit vs. AL-value for PC40 UU79X129X31**



When applied magnetic field providing NI to a setting core for arbitrary AL-value, show each NI value when decreased 20% and 40% from initial AL-value.

**AL-value vs. Air gap length for PC40 UU79X129X31**

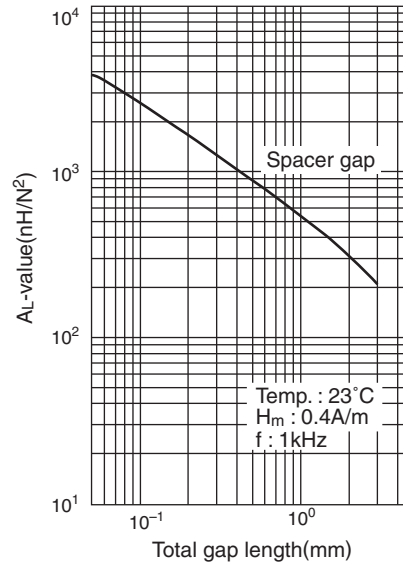

**UU100X151X30**



**Parameter**

|                                |                     |                  |         |
|--------------------------------|---------------------|------------------|---------|
| Core constant                  | C1                  | mm <sup>-1</sup> | 0.38801 |
|                                | C2×10 <sup>-2</sup> | mm <sup>-3</sup> | 0.04241 |
| Effective magnetic path length | ℓ <sub>e</sub>      | mm               | 355     |
| Effective cross-sectional area | A <sub>e</sub>      | mm <sup>2</sup>  | 915     |
| Effective core volume          | V <sub>e</sub>      | mm <sup>3</sup>  | 324860  |
| Minimum cross-sectional area   | A <sub>min.*</sub>  | mm <sup>2</sup>  | 900L*   |
| Winding cross-sectional area   | A <sub>cw</sub>     | mm <sup>2</sup>  | 3600    |
| Weight(approx.)                |                     | g                | 1630    |

\* The symbol followed A min. value shows minimum cross-sectional area part. L is outer pole part, B is the back part.

|                   |                               |
|-------------------|-------------------------------|
| Part No.          | AL-value*(nH/N <sup>2</sup> ) |
| PE22 UU100X151X30 | 5540±25%                      |
| PC40 UU100X151X30 | 6990±25%                      |

\* AL-value: T=23°C, f=1kHz, H<sub>m</sub>=0.4A/m

**NI limit vs. AL-value for PE22 UU100X151X30**



When applied magnetic field providing NI to a setting core for arbitrary AL-value, show each NI value when decreased 20% and 40% from initial AL-value.

**AL-value vs. Air gap length for PE22 UU100X151X30**

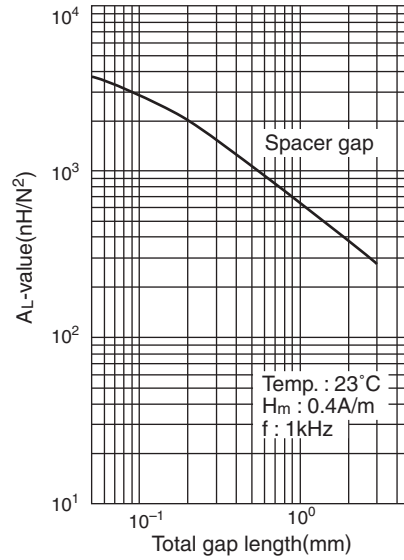

**NI limit vs. AL-value for PC40 UU100X151X30**



When applied magnetic field providing NI to a setting core for arbitrary AL-value, show each NI value when decreased 20% and 40% from initial AL-value.

**AL-value vs. Air gap length for PC40 UU100X151X30**

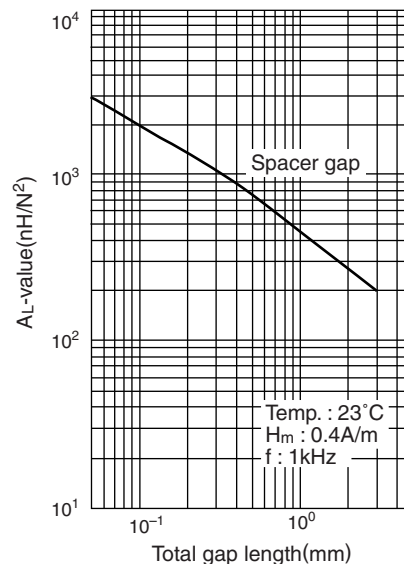

**UU100X160X20**



**Parameter**

|                                      |                     |                  |         |
|--------------------------------------|---------------------|------------------|---------|
| Core constant                        | C1                  | mm <sup>-1</sup> | 0.62375 |
|                                      | C2×10 <sup>-2</sup> | mm <sup>-3</sup> | 0.10396 |
| Effective magnetic path length       | ℓ <sub>e</sub>      | mm               | 374     |
| Effective cross-sectional area       | A <sub>e</sub>      | mm <sup>2</sup>  | 600     |
| Effective core volume                | V <sub>e</sub>      | mm <sup>3</sup>  | 224550  |
| Minimum cross-sectional area         | A <sub>min.*</sub>  | mm <sup>2</sup>  | 600LB*  |
| Cross-sectional winding area of core | A <sub>cw</sub>     | mm <sup>2</sup>  | 4000    |
| Weight(approx.)                      |                     | g                | 1130    |

\* The symbol followed A min. value shows minimum cross-sectional area part. L is outer pole part, B is the back part.

|                   |                               |
|-------------------|-------------------------------|
| Part No.          | AL-value*(nH/N <sup>2</sup> ) |
| PE22 UU100X160X20 | 3460±25%                      |
| PC40 UU100X160X20 | 4360±25%                      |

\* AL-value: T=23°C, f=1kHz, H<sub>m</sub>=0.4A/m

**NI limit vs. AL-value for PE22 UU100X160X20**



**AL-value vs. Air gap length for PE22 UU100X160X20**

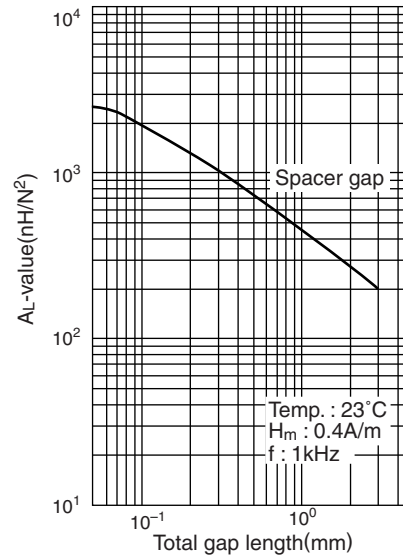

**NI limit vs. AL-value for PC40 UU100X160X20**



**AL-value vs. Air gap length for PC40 UU100X160X20**

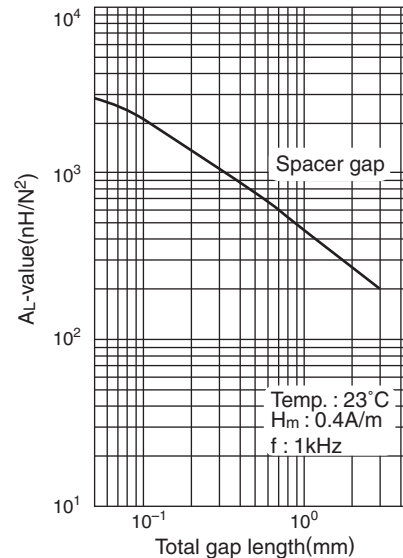



**UU101X115X25**



**Parameter**

|                                      |                     |                  |         |
|--------------------------------------|---------------------|------------------|---------|
| Core constant                        | C1                  | mm <sup>-1</sup> | 0.47757 |
|                                      | C2×10 <sup>-2</sup> | mm <sup>-3</sup> | 0.07373 |
| Effective magnetic path length       | ℓ <sub>e</sub>      | mm               | 309     |
| Effective cross-sectional area       | A <sub>e</sub>      | mm <sup>2</sup>  | 648     |
| Effective core volume                | V <sub>e</sub>      | mm <sup>3</sup>  | 200350  |
| Minimum cross-sectional area         | A <sub>min.*</sub>  | mm <sup>2</sup>  | 635L*   |
| Cross-sectional winding area of core | A <sub>cw</sub>     | mm <sup>2</sup>  | 3260    |
| Weight(approx.)                      |                     | g                | 1000    |

\* The symbol followed A min. value shows minimum cross-sectional area part. L is outer pole part, B is the back part.

|                   |                               |
|-------------------|-------------------------------|
| Part No.          | AL-value*(nH/N <sup>2</sup> ) |
| PE22 UU101X115X25 | 4480±25%                      |
| PC40 UU101X115X25 | 5640±25%                      |

\* AL-value: T=23°C, f=1kHz, H<sub>m</sub>=0.4A/m

**NI limit vs. AL-value for PE22 UU101X115X25**



When applied magnetic field providing NI to a setting core for arbitrary AL-value, show each NI value when decreased 20% and 40% from initial AL-value.

**AL-value vs. Air gap length for PE22 UU101X115X25**



Temp. : 23°C  
H<sub>m</sub> : 0.4A/m  
f : 1kHz

**NI limit vs. AL-value for PC40 UU101X115X25**



When applied magnetic field providing NI to a setting core for arbitrary AL-value, show each NI value when decreased 20% and 40% from initial AL-value.

**AL-value vs. Air gap length for PC40 UU101X115X25**



Temp. : 23°C  
H<sub>m</sub> : 0.4A/m  
f : 1kHz

**UU120X160X20**

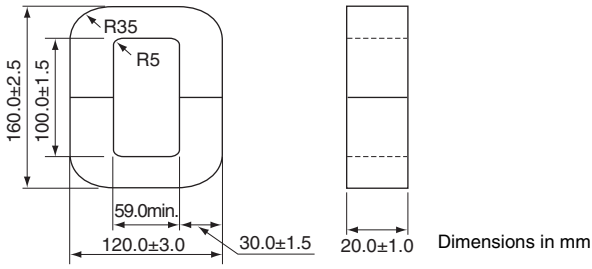

**Parameter**

|                                      |                     |                  |         |
|--------------------------------------|---------------------|------------------|---------|
| Core constant                        | C1                  | mm <sup>-1</sup> | 0.69041 |
|                                      | C2×10 <sup>-2</sup> | mm <sup>-3</sup> | 0.11507 |
| Effective magnetic path length       | ℓ <sub>e</sub>      | mm               | 414     |
| Effective cross-sectional area       | A <sub>e</sub>      | mm <sup>2</sup>  | 600     |
| Effective core volume                | V <sub>e</sub>      | mm <sup>3</sup>  | 248550  |
| Minimum cross-sectional area         | A <sub>min.*</sub>  | mm <sup>2</sup>  | 600LB*  |
| Cross-sectional winding area of core | A <sub>cw</sub>     | mm <sup>2</sup>  | 6000    |
| Weight(approx.)                      |                     | g                | 1240    |

\* The symbol followed A min. value shows minimum cross-sectional area part.  
L is outer pole part, B is the back part.

| Part No.          | AL-value*(nH/N <sup>2</sup> ) |
|-------------------|-------------------------------|
| PE22 UU120X160X20 | 3140±25%                      |
| PC40 UU120X160X20 | 3960±25%                      |

\* AL-value: T=23°C, f=1kHz, H<sub>m</sub>=0.4A/m

**NI limit vs. AL-value for PE22 UU120X160X20**



When applied magnetic field providing NI to a setting core for arbitrary AL-value, show each NI value when decreased 20% and 40% from initial AL-value.

**AL-value vs. Air gap length for PE22 UU120X160X20**



**NI limit vs. AL-value for PC40 UU120X160X20**



When applied magnetic field providing NI to a setting core for arbitrary AL-value, show each NI value when decreased 20% and 40% from initial AL-value.

**AL-value vs. Air gap length for PC40 UU120X160X20**



## UI Series

### UI CORE

#### CORE SHAPES AND DIMENSIONS/CHARACTERISTICS



#### PRODUCT IDENTIFICATION

PE22 UI 80 × 95 × 30 N  
 (1) (2) (3) (4) (5)

- (1) Material name
- (2) Shape
- (3) Dimension A
- (4) Dimension B+I
- (5) Dimension C

| Part No.           | AL*(nH/N <sup>2</sup> )<br>±25% | Dimensions (mm) |           |          |          |          |          |          |         |  |
|--------------------|---------------------------------|-----------------|-----------|----------|----------|----------|----------|----------|---------|--|
|                    |                                 | A               | B+I       | C        | E        | F        | H        | I        | R       |  |
| PE22 UI80×95×30N   | 5010                            |                 |           |          |          |          |          |          |         |  |
| PC40 UI80×95×30N   | 6280                            | 80.0±1.5        | 95.0±1.0  | 30.0±0.5 | 39.0min. | 55.0±0.5 | 20.0±0.5 | 20.0±0.5 | 1.0max. |  |
| PE90 UI80×95×30N   | 6007                            |                 |           |          |          |          |          |          |         |  |
| PE22 UI100×105×30N | 7220                            |                 |           |          |          |          |          |          |         |  |
| PC40 UI100×105×30N | 9065                            | 100.0±1.5       | 105.0±1.0 | 30.0±0.5 | 39.0min. | 45.0±0.5 | 30.0±0.5 | 30.0±0.5 | 1.0max. |  |
| PE90 UI100×105×30N | 8671                            |                 |           |          |          |          |          |          |         |  |

\* Measuring condition: T=23°C, f=1kHz, H<sub>m</sub>=0.4A/m

| Part No.           | Core factor                        |  |                                   |                     |                                   | Weight (g) |
|--------------------|------------------------------------|--|-----------------------------------|---------------------|-----------------------------------|------------|
|                    | C <sub>1</sub> (mm <sup>-1</sup> ) | C <sub>2</sub> ×10 <sup>-2</sup> (mm <sup>-3</sup> ) | A <sub>e</sub> (mm <sup>2</sup> ) | ℓ <sub>e</sub> (mm) | V <sub>e</sub> (mm <sup>3</sup> ) |            |
| PE22 UI80×95×30N   |                                    |  |                                   |                     |                                   | 778        |
| PC40 UI80×95×30N   | 0.42139                            | 0.07023  | 600                               | 253                 | 151700                            | 778        |
| PE90 UI80×95×30N   |                                    |  |                                   |                     |                                   | 794        |
| PE22 UI100×105×30N |                                    |  |                                   |                     |                                   | 1253       |
| PC40 UI100×105×30N | 0.29361                            | 0.03262  | 900                               | 264                 | 237820                            | 1253       |
| PE90 UI100×105×30N |                                    |  |                                   |                     |                                   | 1279       |

## EC Series

### EC CORE

#### CORE SHAPES AND DIMENSIONS/CHARACTERISTICS



#### PRODUCT IDENTIFICATION

PE22 EC 90 × 90 × 30  
(1) (2) (3) (4) (5)

- (1) Material name
- (2) Shape
- (3) Dimension A
- (4) Dimension B×2
- (5) Dimension C

### EC CORE BOBBIN

#### FOR EC70



Bobbin is optional parts.

#### FOR EC90, 120



Bobbin is optional parts.

| Part No.          | AL*(nH/N <sup>2</sup> )<br>±25% | Dimensions (mm) |           |          |          |          |          |     |      |         |      |                        |
|-------------------|---------------------------------|-----------------|-----------|----------|----------|----------|----------|-----|------|---------|------|------------------------|
|                   |                                 | A               | B×2       | C        | øD       | øE       | F×2      | M   | J    | R       | K    | K×2F(mm <sup>2</sup> ) |
| PE22 EC70×69×16   | 3910                            | 70.0±1.7        | 69.0±1.0  | 16.4±0.5 | 16.4±0.5 | 43.3min. | 45.5±1.0 | 5.2 | 4.75 | 1max.   | 14.1 | 639                    |
| PC40 EC70×69×16   | 4845                            |                 |           |          |          |          |          |     |      |         |      |                        |
| PE90 EC70×69×16   | 4634                            |                 |           |          |          |          |          |     |      |         |      |                        |
| PE22 EC90×90×30   | 5925                            | 90.0±1.8        | 90.0±1.3  | 30.0±1.0 | 30.0±1.0 | 68.5min. | 71.0±1.0 | 5.5 | 6.0  | 1max.   | 20.0 | 1420                   |
| PC40 EC90×90×30   | 7415                            |                 |           |          |          |          |          |     |      |         |      |                        |
| PE90 EC90×90×30   | 7093                            |                 |           |          |          |          |          |     |      |         |      |                        |
| PE22 EC120×101×30 | 6395                            | 120.0±2.0       | 101.0±1.3 | 30.0±1.0 | 30.0±1.0 | 93.3min. | 71.0±1.0 | 5.5 | 6.03 | 1.5max. | 32.5 | 2307                   |
| PC40 EC120×101×30 | 8025                            |                 |           |          |          |          |          |     |      |         |      |                        |
| PE90 EC120×101×30 | 7676                            |                 |           |          |          |          |          |     |      |         |      |                        |

\* Measuring condition: T=23°C, f=1kHz, H<sub>m</sub>=0.4A/m

| Part No.          | Core factor                        |  |                                   |                     |                                   |      | Weight (g) |
|-------------------|------------------------------------|--|-----------------------------------|---------------------|-----------------------------------|------|------------|
|                   | C <sub>1</sub> (mm <sup>-1</sup> ) | C <sub>2</sub> ×10 <sup>-2</sup> (mm <sup>-3</sup> ) | A <sub>e</sub> (mm <sup>2</sup> ) | ℓ <sub>e</sub> (mm) | V <sub>e</sub> (mm <sup>3</sup> ) |      |            |
| PE22 EC70×69×16   |                                    |  |                                   |                     |                                   | 250  |            |
| PC40 EC70×69×16   | 0.5138891                          | 0.18322  | 280                               | 144                 | 40420                             | 250  |            |
| PE90 EC70×69×16   |                                    |  |                                   |                     |                                   | 255  |            |
| PE22 EC90×90×30   |                                    |  |                                   |                     |                                   | 635  |            |
| PC40 EC90×90×30   | 0.3533380                          | 0.05648  | 626                               | 221                 | 138270                            | 635  |            |
| PE90 EC90×90×30   |                                    |  |                                   |                     |                                   | 648  |            |
| PE22 EC120×101×30 |                                    |  |                                   |                     |                                   | 986  |            |
| PC40 EC120×101×30 | 0.3300745                          | 0.04278  | 772                               | 255                 | 196490                            | 986  |            |
| PE90 EC120×101×30 |                                    |  |                                   |                     |                                   | 1007 |            |

### EC CORE BOBBIN

| Part No. | Dimensions (mm) |          |          |          |          |          |      | Cross-sectional winding area<br>A <sub>w</sub> (mm <sup>2</sup> ) | Average winding length<br>ℓ <sub>w</sub> (mm) | Weight (g) | Material |
|----------|-----------------|----------|----------|----------|----------|----------|------|---|---|------------|----------|
|          | øA              | øB       | C        | X        | Y        | Z        | t*   |   |   |            |          |
| BEC70    | 42.5±0.5        | 19.3±0.3 | 41.5±2.5 | 70.0±1.5 | 56.0±1.5 | 57.0±2.0 | 1.13 | 471.4   | 98  | 19.0       | PBT      |
| BEC90    | 67.0±0.7        | 35.0±0.5 | 65.0±3.0 | 79.5±0.5 | 76.0±1.0 | 89.5±2.5 | 1.7  | 1047  | 162   | 82.0       | PBT      |

\* Bobbin minimum thickness

**EC70X69X16**



Dimensions in mm

**Parameter**

|                                 |                     |                  |           |
|---------------------------------|---------------------|------------------|-----------|
| Core constant                   | C1                  | mm <sup>-1</sup> | 0.5138891 |
|                                 | C2×10 <sup>-2</sup> | mm <sup>-3</sup> | 0.18322   |
| Effective magnetic path length  | ℓ <sub>e</sub>      | mm               | 144       |
| Effective cross-sectional area  | A <sub>e</sub>      | mm <sup>2</sup>  | 280       |
| Effective core volume           | V <sub>e</sub>      | mm <sup>3</sup>  | 40420     |
| Cross-sectional center leg area | A <sub>c</sub>      | mm <sup>2</sup>  | 211       |
| Minimum cross-sectional area    | A <sub>min.*</sub>  | mm <sup>2</sup>  | 211C*     |
| Winding cross-sectional area    | A <sub>cw</sub>     | mm <sup>2</sup>  | 642       |
| Weight(approx.)                 |                     | g                | 250       |

\* The symbol followed A min. value shows minimum cross-sectional area part.  
C is center pole part, L is outer pole part, B is the back part.

| Part No.        | AL-value*(nH/N <sup>2</sup> ) | Calculated output power(kW) (forward converter mode) |
|-----------------|-------------------------------|--|
| PE22 EC70X69X16 | 3910±25%                      | 1.1(100kHz)  |
| PC40 EC70X69X16 | 4845±25%                      | 1.2(100kHz)  |

\* AL-value: T=23°C, f=1kHz, H<sub>m</sub>=0.4A/m

**NI limit vs. AL-value for PE22 EC70X69X16**



When applied magnetic field providing NI to a setting core for arbitrary AL-value, show each NI value when decreased 20% and 40% from initial AL-value.

**AL-value vs. Air gap length for PE22 EC70X69X16**



**NI limit vs. AL-value for PC40 EC70X69X16**

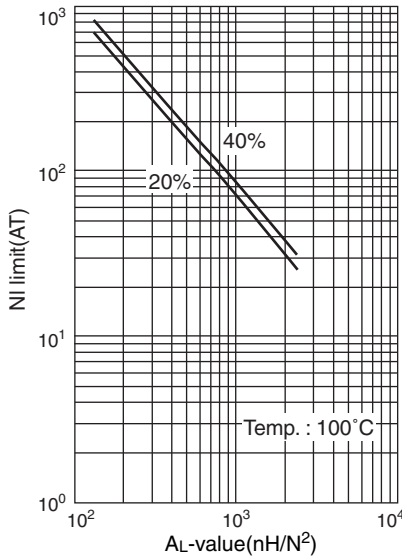

When applied magnetic field providing NI to a setting core for arbitrary AL-value, show each NI value when decreased 20% and 40% from initial AL-value.

**AL-value vs. Air gap length for PC40 EC70X69X16**

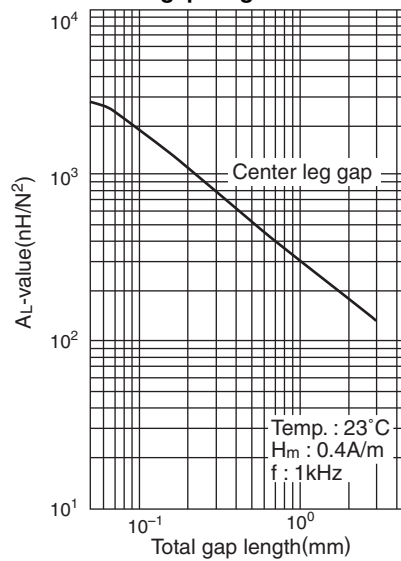

**EC90X90X30**



**Parameter**

|                                 |                     |                  |           |
|---------------------------------|---------------------|------------------|-----------|
| Core constant                   | C1                  | mm <sup>-1</sup> | 0.3533380 |
|                                 | C2×10 <sup>-2</sup> | mm <sup>-3</sup> | 0.05648   |
| Effective magnetic path length  | ℓ <sub>e</sub>      | mm               | 221       |
| Effective cross-sectional area  | A <sub>e</sub>      | mm <sup>2</sup>  | 626       |
| Effective core volume           | V <sub>e</sub>      | mm <sup>3</sup>  | 138270    |
| Cross-sectional center leg area | A <sub>c</sub>      | mm <sup>2</sup>  | 707       |
| Minimum cross-sectional area    | A <sub>min.*</sub>  | mm <sup>2</sup>  | 570B*     |
| Winding cross-sectional area    | A <sub>cw</sub>     | mm <sup>2</sup>  | 1420      |
| Weight(approx.)                 |                     | g                | 635       |

\* The symbol followed A min. value shows minimum cross-sectional area part.  
C is center pole part, L is outer pole part, B is the back part.

| Part No.        | AL-value*(nH/N <sup>2</sup> ) | Calculated output power(kW) (forward converter mode) |
|-----------------|-------------------------------|--|
| PE22 EC90X90X30 | 5925±25%                      | 3.2(100kHz)  |
| PC40 EC90X90X30 | 7415±25%                      | 3.4(100kHz)  |

\* AL-value: T=23°C, f=1kHz, H<sub>m</sub>=0.4A/m

**NI limit vs. AL-value for PE22 EC90X90X30**



When applied magnetic field providing NI to a setting core for arbitrary AL-value, show each NI value when decreased 20% and 40% from initial AL-value.

**AL-value vs. Air gap length for PE22 EC90X90X30**

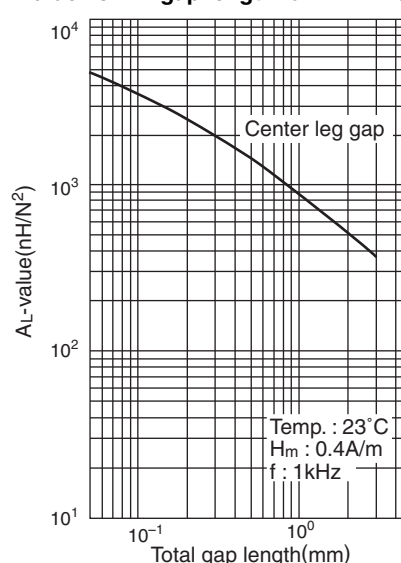

**NI limit vs. AL-value for PC40 EC90X90X30**

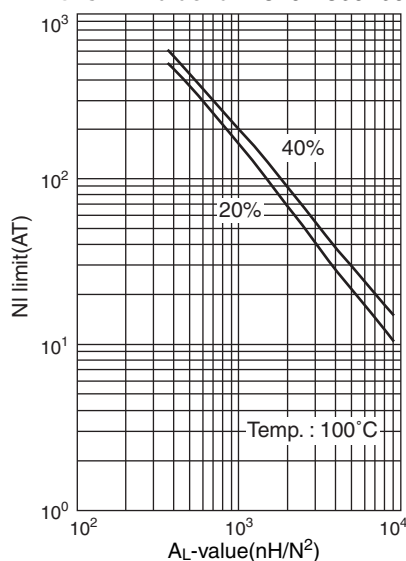

When applied magnetic field providing NI to a setting core for arbitrary AL-value, show each NI value when decreased 20% and 40% from initial AL-value.

**AL-value vs. Air gap length for PC40 EC90X90X30**

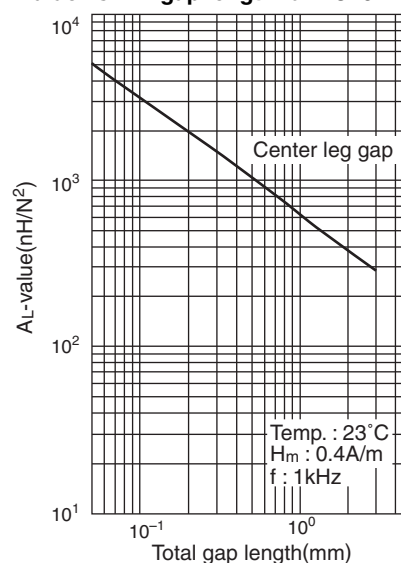

**EC120X101X30**



**Parameter**

|                                 |                     |                  |           |
|---------------------------------|---------------------|------------------|-----------|
| Core constant                   | C1                  | mm <sup>-1</sup> | 0.3300745 |
|                                 | C2×10 <sup>-2</sup> | mm <sup>-3</sup> | 0.04278   |
| Effective magnetic path length  | ℓ <sub>e</sub>      | mm               | 255       |
| Effective cross-sectional area  | A <sub>e</sub>      | mm <sup>2</sup>  | 773       |
| Effective core volume           | V <sub>e</sub>      | mm <sup>3</sup>  | 196490    |
| Cross-sectional center leg area | A <sub>c</sub>      | mm <sup>2</sup>  | 707       |
| Minimum cross-sectional area    | A <sub>min.*</sub>  | mm <sup>2</sup>  | 707C*     |
| Winding cross-sectional area    | A <sub>cw</sub>     | mm <sup>2</sup>  | 2307      |
| Weight(approx.)                 | g                   |                  | 986       |

\* The symbol followed A min. value shows minimum cross-sectional area part.  
C is center pole part, L is outer pole part, B is the back part.

|                   |                               |  |
|-------------------|-------------------------------|--|
| Part No.          | AL-value*(nH/N <sup>2</sup> ) | Calculated output power(kW) (forward converter mode) |
| PE22 EC120X101X30 | 6395±25%                      | 4.3(100kHz)  |
| PC40 EC120X101X30 | 8025±25%                      | 4.5(100kHz)  |

\* AL-value: T=23°C, f=1kHz, H<sub>m</sub>=0.4A/m

**NI limit vs. AL-value for PE22 EC120X101X30**



When applied magnetic field providing NI to a setting core for arbitrary AL-value, show each NI value when decreased 20% and 40% from initial AL-value.

**AL-value vs. Air gap length for PE22 EC120X101X30**



**NI limit vs. AL-value for PC40 EC120X101X30**



When applied magnetic field providing NI to a setting core for arbitrary AL-value, show each NI value when decreased 20% and 40% from initial AL-value.

**AL-value vs. Air gap length for PC40 EC120X101X30**

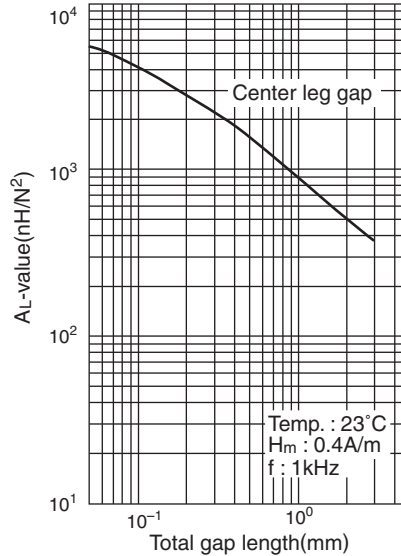

## EIC Series

### EIC CORE

#### CORE SHAPES AND DIMENSIONS/CHARACTERISTICS



#### PRODUCT IDENTIFICATION

PE22 EIC 90 × 55 × 30  
(1) (2) (3) (4) (5)

- (1) Material name
- (2) Shape
- (3) Dimension A
- (4) Dimension B+l
- (5) Dimension C

| Part No.          | AL*(nH/N <sup>2</sup> )<br>±25% | Dimensions (mm) |           |          |          |          |           |           |     |      |      |  |
|-------------------|---------------------------------|-----------------|-----------|----------|----------|----------|-----------|-----------|-----|------|------|--|
|                   |                                 | A               | B+l       | C        | øD       | øE       | F         | I         | M   | J    | K    |  |
| PE22 EIC70×46×16  | 5550                            |                 |           |          |          |          |           |           |     |      |      |  |
| PC40 EIC70×46×16  | 6810                            | 70.0±1.7        | 46.25±1.0 | 16.4±0.5 | 16.4±0.5 | 43.3min. | 22.75±0.5 | 11.75±0.5 | 5.2 | 4.75 | 14.1 |  |
| PE90 EIC70×46×16  | 6514                            |                 |           |          |          |          |           |           |     |      |      |  |
| PE22 EIC90×55×30  | 8350                            |                 |           |          |          |          |           |           |     |      |      |  |
| PC40 EIC90×55×30  | 10365                           | 90.0±1.8        | 55.0±1.0  | 30.0±1.0 | 30.0±1.0 | 68.5min. | 35.5±0.5  | 10.0±0.35 | 5.5 | 6.0  | 20.0 |  |
| PE90 EIC90×55×30  | 9914                            |                 |           |          |          |          |           |           |     |      |      |  |
| PE22 EIC120×65×30 | 8890                            |                 |           |          |          |          |           |           |     |      |      |  |
| PC40 EIC120×65×30 | 11085                           | 120.0±2.0       | 65.5±1.3  | 30.0±1.0 | 30.0±1.0 | 93.3min. | 35.5±0.5  | 15.0±0.65 | 5.5 | 6.0  | 32.5 |  |
| PE90 EIC120×65×30 | 10603                           |                 |           |          |          |          |           |           |     |      |      |  |

\*Measuring condition: T=23°C, f=1kHz, H<sub>m</sub>=0.4A/m

| Part No.          | Core factor                        |  |                                   |                     |                                   | Weight (g) |
|-------------------|------------------------------------|--|-----------------------------------|---------------------|-----------------------------------|------------|
|                   | C <sub>1</sub> (mm <sup>-1</sup> ) | C <sub>2</sub> ×10 <sup>-2</sup> (mm <sup>-3</sup> ) | A <sub>e</sub> (mm <sup>2</sup> ) | ℓ <sub>e</sub> (mm) | V <sub>e</sub> (mm <sup>3</sup> ) |            |
| PE22 EIC70×46×16  |                                    |  |                                   |                     |                                   | 188        |
| PC40 EIC70×46×16  | 0.3479                             | 0.1173   | 297                               | 103                 | 30601                             | 188        |
| PE90 EIC70×46×16  |                                    |  |                                   |                     |                                   | 191        |
| PE22 EIC90×55×30  |                                    |  |                                   |                     |                                   | 469        |
| PC40 EIC90×55×30  | 0.2422                             | 0.0388   | 624                               | 151                 | 94432                             | 469        |
| PE90 EIC90×55×30  |                                    |  |                                   |                     |                                   | 479        |
| PE22 EIC120×65×30 |                                    |  |                                   |                     |                                   | 747        |
| PC40 EIC120×65×30 | 0.2319                             | 0.0292   | 794                               | 184                 | 146310                            | 747        |
| PE90 EIC120×65×30 |                                    |  |                                   |                     |                                   | 763        |



### EIC90X55X30



#### Parameter

|                                 |                                  |                  |        |
|---------------------------------|----------------------------------|------------------|--------|
| Core constant                   | C <sub>1</sub>                   | mm <sup>-1</sup> | 0.2422 |
|                                 | C <sub>2</sub> ×10 <sup>-2</sup> | mm <sup>-3</sup> | 0.0388 |
| Effective magnetic path length  | ℓ <sub>e</sub>                   | mm               | 151    |
| Effective cross-sectional area  | A <sub>e</sub>                   | mm <sup>2</sup>  | 624    |
| Effective core volume           | V <sub>e</sub>                   | mm <sup>3</sup>  | 94432  |
| Cross-sectional center leg area | A <sub>c</sub>                   | mm <sup>2</sup>  | 707    |
| Minimum cross-sectional area    | A <sub>min.*</sub>               | mm <sup>2</sup>  | 586B*  |
| Winding cross-sectional area    | A <sub>cw</sub>                  | mm <sup>2</sup>  | 710    |
| Weight(approx.)                 | g                                |                  | 469    |

\* The symbol followed A min. value shows minimum cross-sectional area part.  
C is center pole part, L is outer pole part, B is the back part.

| Part No.         | AL-value*(nH/N <sup>2</sup> ) | Calculated output power(kW) (forward converter mode) |
|------------------|-------------------------------|--|
| PE22 EIC90X55X30 | 8350±25%                      | 1.8(100kHz)  |
| PC40 EIC90X55X30 | 10365±25%                     | 1.9(100kHz)  |
| PE90 EIC90X55X30 | 9914±25%                      | —  |

\* AL-value: T=23°C, f=1kHz, H<sub>m</sub>=0.4A/m

### EIC120X65X30



#### Parameter

|                                      |                                  |                  |        |
|--------------------------------------|----------------------------------|------------------|--------|
| Core constant                        | C <sub>1</sub>                   | mm <sup>-1</sup> | 0.2319 |
|                                      | C <sub>2</sub> ×10 <sup>-2</sup> | mm <sup>-3</sup> | 0.0292 |
| Effective magnetic path length       | ℓ <sub>e</sub>                   | mm               | 184    |
| Effective cross-sectional area       | A <sub>e</sub>                   | mm <sup>2</sup>  | 794    |
| Effective core volume                | V <sub>e</sub>                   | mm <sup>3</sup>  | 146310 |
| Cross-sectional center leg area      | A <sub>c</sub>                   | mm <sup>2</sup>  | 707    |
| Minimum cross-sectional area         | A <sub>min.*</sub>               | mm <sup>2</sup>  | 707C*  |
| Cross-sectional winding area of core | A <sub>cw</sub>                  | mm <sup>2</sup>  | 1154   |
| Weight(approx.)                      | g                                |                  | 747    |

\* The symbol followed A min. value shows minimum cross-sectional area part.  
C is center pole part, L is outer pole part, B is the back part.

| Part No.          | AL-value*(nH/N <sup>2</sup> ) | Calculated output power(kW) (forward converter mode) |
|-------------------|-------------------------------|--|
| PE22 EIC120X65X30 | 8890±25%                      | 2.8(100kHz)  |
| PC40 EIC120X65X30 | 11085±25%                     | 2.9(100kHz)  |
| PE90 EIC120X65X30 | 10603±25%                     | —  |

\* AL-value: T=23°C, f=1kHz, H<sub>m</sub>=0.4A/m

• Available customize core like this. Please specify when ordering.

## EE Series

### EE CORE

#### CORE SHAPES AND DIMENSIONS/CHARACTERISTICS



#### PRODUCT IDENTIFICATION

PE22 EE 320 × 250 × 20  
 (1) (2) (3) (4) (5)

- (1) Material name
- (2) Shape
- (3) Dimension A
- (4) Dimension 2B
- (5) Dimension C

| Part No.          | AL*(nH/N <sup>2</sup> )<br>±25% | Dimensions (mm) |           |          |          |          |          |          |         |      |                        |  |
|-------------------|---------------------------------|-----------------|-----------|----------|----------|----------|----------|----------|---------|------|------------------------|--|
|                   |                                 | A               | 2B        | C        | D        | E        | 2F       | H        | R       | K    | K×2F(mm <sup>2</sup> ) |  |
| PE22 EE70×91×19   | 3930                            |                 |           |          |          |          |          |          |         |      |                        |  |
| PC40 EE70×91×19   | 4910                            | 70.0±1.5        | 91.0±1.0  | 19.5±0.5 | 19.5±0.5 | 48.5min. | 71.0±1.0 | 10.0±0.5 | 0       | 15.3 | 1086                   |  |
| PE90 EE70×91×19   | 4697                            |                 |           |          |          |          |          |          |         |      |                        |  |
| PE22 EE80×76×20   | 4590                            |                 |           |          |          |          |          |          |         |      |                        |  |
| PC40 EE80×76×20   | 5720                            | 80.0±1.5        | 76.0±1.0  | 20.0±0.5 | 20.0±0.5 | 58.5min. | 55.0±0.8 | 10.0±0.5 | 0.5max. | 20.0 | 1100                   |  |
| PE90 EE80×76×20   | 5471                            |                 |           |          |          |          |          |          |         |      |                        |  |
| PE22 EE90×56×16   | 5960                            |                 |           |          |          |          |          |          |         |      |                        |  |
| PC40 EE90×56×16   | 7380                            | 90.0±2.0        | 56.4±1.0  | 16.5±0.5 | 25.0±1.0 | 63.0min. | 30.4±1.0 | 12.5±0.5 | 0.5max. | 20.0 | 608                    |  |
| PE90 EE90×56×16   | 7059                            |                 |           |          |          |          |          |          |         |      |                        |  |
| PE22 EE70×108×31N | 6360                            |                 |           |          |          |          |          |          |         |      |                        |  |
| PC40 EE70×108×31N | 7970                            | 70.0±1.5        | 108.0±1.0 | 31.6±0.5 | 22.2±0.5 | 46.3min. | 85.6±1.0 | 11.1±0.5 | 2.0max. | 12.8 | 1096                   |  |
| PE90 EE70×108×31N | 7623                            |                 |           |          |          |          |          |          |         |      |                        |  |

\* Measuring condition: T=23°C, f=1kHz, H<sub>m</sub>=0.4A/m

| Part No.          | Core factor                        |  |                                   |                     |                                   | Weight (g) |
|-------------------|------------------------------------|--|-----------------------------------|---------------------|-----------------------------------|------------|
|                   | C <sub>1</sub> (mm <sup>-1</sup> ) | C <sub>2</sub> ×10 <sup>-2</sup> (mm <sup>-3</sup> ) | A <sub>e</sub> (mm <sup>2</sup> ) | l <sub>e</sub> (mm) | V <sub>e</sub> (mm <sup>3</sup> ) |            |
| PE22 EE70×91×19   |                                    |  |                                   |                     |                                   | 394        |
| PC40 EE70×91×19   | 0.52779                            | 0.13669  | 386                               | 204                 | 78690                             | 394        |
| PE90 EE70×91×19   |                                    |  |                                   |                     |                                   | 402        |
| PE22 EE80×76×20   |                                    |  |                                   |                     |                                   | 372        |
| PC40 EE80×76×20   | 0.44878                            | 0.11058  | 406                               | 182                 | 73910                             | 372        |
| PE90 EE80×76×20   |                                    |  |                                   |                     |                                   | 380        |
| PE22 EE90×56×16   |                                    |  |                                   |                     |                                   | 306        |
| PC40 EE90×56×16   | 0.33583                            | 0.08009  | 419                               | 141                 | 59050                             | 306        |
| PE90 EE90×56×16   |                                    |  |                                   |                     |                                   | 312        |
| PE22 EE70×108×31N |                                    |  |                                   |                     |                                   | 815        |
| PC40 EE70×108×31N | 0.32992                            | 0.04695  | 703                               | 232                 | 162900                            | 815        |
| PE90 EE70×108×31N |                                    |  |                                   |                     |                                   | 832        |

## EE CORE BOBBIN



Bobbin is optional parts.

## EE CORE BOBBIN

| Part No. | Dimensions (mm) |                |                |                |          |          | Cross-sectional winding area<br>$A_w(\text{mm}^2)$ | Average winding length<br>$\bar{l}_w(\text{mm})$ | Weight (g) | Material |
|----------|-----------------|----------------|----------------|----------------|----------|----------|--|--|------------|----------|
|          | A <sub>1</sub>  | A <sub>2</sub> | B <sub>1</sub> | B <sub>2</sub> | C        | Z        |  |  |            |          |
| BE-80-S  | 56.5±0.5        | 61.0±0.5       | 25.2±0.5       | 25.2±0.5       | 47.5±2.5 | 51.5±2.5 | 747  | 168  | 32         | PBT      |
| BE-80-W  | 56.5±0.5        | 81.5±0.7       | 25.2±0.5       | 45.8±0.5       | 47.5±2.5 | 51.5±2.5 | 747  | 209  | 41         | PBT      |

**EE70X91X19**



**Parameter**

|                                 |                                  |                  |        |
|---------------------------------|----------------------------------|------------------|--------|
| Core constant                   | C <sub>1</sub>                   | mm <sup>-1</sup> | 0.5278 |
|                                 | C <sub>2</sub> ×10 <sup>-2</sup> | mm <sup>-3</sup> | 0.1367 |
| Effective magnetic path length  | ℓ <sub>e</sub>                   | mm               | 204    |
| Effective cross-sectional area  | A <sub>e</sub>                   | mm <sup>2</sup>  | 386    |
| Effective core volume           | V <sub>e</sub>                   | mm <sup>3</sup>  | 78690  |
| Cross-sectional center leg area | A <sub>c</sub>                   | mm <sup>2</sup>  | 380    |
| Minimum cross-sectional area    | A <sub>min.*</sub>               | mm <sup>2</sup>  | 380C*  |
| Winding cross-sectional area    | A <sub>cw</sub>                  | mm <sup>2</sup>  | 1086   |
| Weight(approx.)                 | g                                |                  | 394    |

\* The symbol followed A min. value shows minimum cross-sectional area part.  
C is center pole part, L is outer pole part, B is the back part.

| Part No.        | AL-value*(nH/N <sup>2</sup> ) | Calculated output power(kW) (forward converter mode) |
|-----------------|-------------------------------|--|
| PE22 EE70X91X19 | 3930±25%                      | 1.4(100kHz)  |
| PC40 EE70X91X19 | 4910±25%                      | 1.6(100kHz)  |

\* AL-value: T=23°C, f=1kHz, H<sub>m</sub>=0.4A/m

**NI limit vs. AL-value for PE22 EE70X91X19**



When applied magnetic field providing NI to a setting core for arbitrary AL-value, show each NI value when decreased 20% and 40% from initial AL-value.

**AL-value vs. Air gap length for PE22 EE70X91X19**

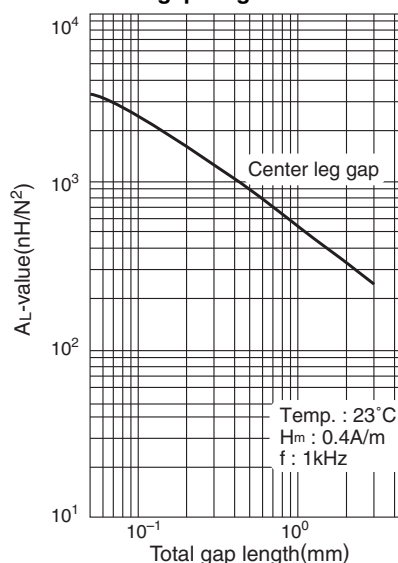

**NI limit vs. AL-value for PC40 EE70X91X19**



When applied magnetic field providing NI to a setting core for arbitrary AL-value, show each NI value when decreased 20% and 40% from initial AL-value.

**AL-value vs. Air gap length for PC40 EE70X91X19**

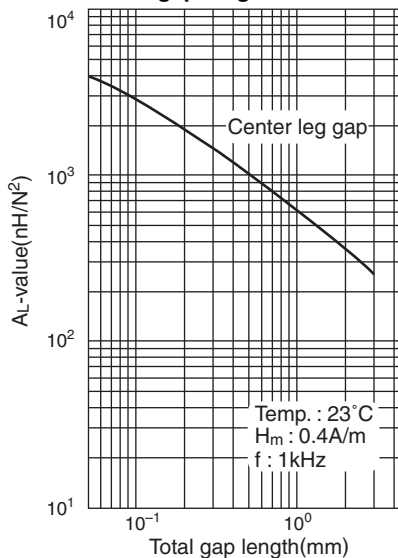

**EE80X76X20**



**Parameter**

|                                 |                                  |                  |         |
|---------------------------------|----------------------------------|------------------|---------|
| Core constant                   | C <sub>1</sub>                   | mm <sup>-1</sup> | 0.44878 |
|                                 | C <sub>2</sub> ×10 <sup>-2</sup> | mm <sup>-3</sup> | 0.1106  |
| Effective magnetic path length  | ℓ <sub>e</sub>                   | mm               | 182     |
| Effective cross-sectional area  | A <sub>e</sub>                   | mm <sup>2</sup>  | 406     |
| Effective core volume           | V <sub>e</sub>                   | mm <sup>3</sup>  | 73910   |
| Cross-sectional center leg area | A <sub>c</sub>                   | mm <sup>2</sup>  | 400     |
| Minimum cross-sectional area    | A <sub>min.*</sub>               | mm <sup>2</sup>  | 400LC*  |
| Winding cross-sectional area    | A <sub>cw</sub>                  | mm <sup>2</sup>  | 1100    |
| Weight(approx.)                 | g                                |                  | 372     |

\* The symbol followed A min. value shows minimum cross-sectional area part. C is center pole part, L is outer pole part, B is the back part.

| Part No.        | AL-value*(nH/N <sup>2</sup> ) | Calculated output power(kW) (forward converter mode) |
|-----------------|-------------------------------|--|
| PE22 EE80X76X20 | 4590±25%                      | 1.4(100kHz)  |
| PC40 EE80X76X20 | 5720±25%                      | 1.5(100kHz)  |

\* AL-value: T=23°C, f=1kHz, H<sub>m</sub>=0.4A/m

**NI limit vs. AL-value for PE22 EE80X76X20**



When applied magnetic field providing NI to a setting core for arbitrary AL-value, show each NI value when decreased 20% and 40% from initial AL-value.

**AL-value vs. Air gap length for PE22 EE80X76X20**



**NI limit vs. AL-value for PC40 EE80X76X20**



When applied magnetic field providing NI to a setting core for arbitrary AL-value, show each NI value when decreased 20% and 40% from initial AL-value.

**AL-value vs. Air gap length for PC40 EE80X76X20**



**EE90X56X16**

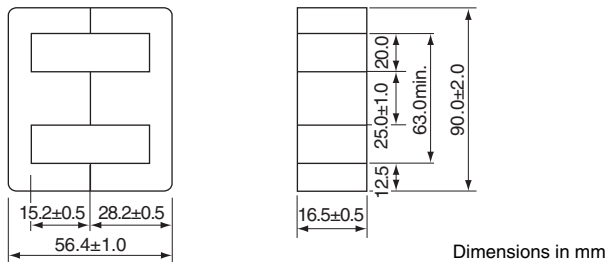

**Parameter**

|                                 |                                  |                  |         |
|---------------------------------|----------------------------------|------------------|---------|
| Core constant                   | C <sub>1</sub>                   | mm <sup>-1</sup> | 0.33583 |
|                                 | C <sub>2</sub> ×10 <sup>-2</sup> | mm <sup>-3</sup> | 0.0801  |
| Effective magnetic path length  | ℓ <sub>e</sub>                   | mm               | 141     |
| Effective cross-sectional area  | A <sub>e</sub>                   | mm <sup>2</sup>  | 419     |
| Effective core volume           | V <sub>e</sub>                   | mm <sup>3</sup>  | 59050   |
| Cross-sectional center leg area | A <sub>c</sub>                   | mm <sup>2</sup>  | 413     |
| Minimum cross-sectional area    | A <sub>min.*</sub>               | mm <sup>2</sup>  | 413LC*  |
| Winding cross-sectional area    | A <sub>cw</sub>                  | mm <sup>2</sup>  | 608     |
| Weight(approx.)                 |                                  | g                | 306     |

\* The symbol followed A min. value shows minimum cross-sectional area part. C is center pole part, L is outer pole part, B is the back part.

| Part No.        | AL-value*(nH/N <sup>2</sup> ) | Calculated output power(kW) (forward converter mode) |
|-----------------|-------------------------------|--|
| PE22 EE90X56X16 | 5960±25%                      | 1.2(100kHz)  |
| PC40 EE90X56X16 | 7380±25%                      | 1.3(100kHz)  |

\* AL-value: T=23°C, f=1kHz, H<sub>m</sub>=0.4A/m

**NI limit vs. AL-value for PE22 EE90X56X16**

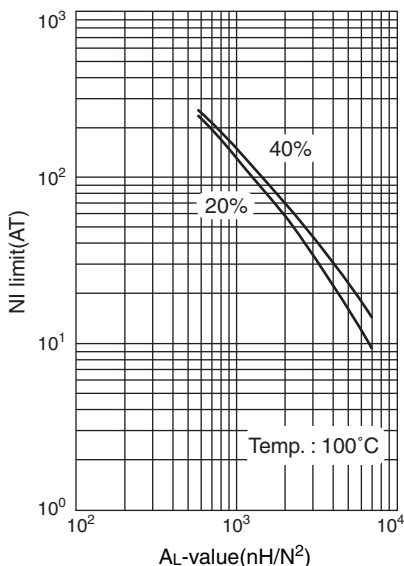

When applied magnetic field providing NI to a setting core for arbitrary AL-value, show each NI value when decreased 20% and 40% from initial AL-value.

**AL-value vs. Air gap length for PE22 EE90X56X16**

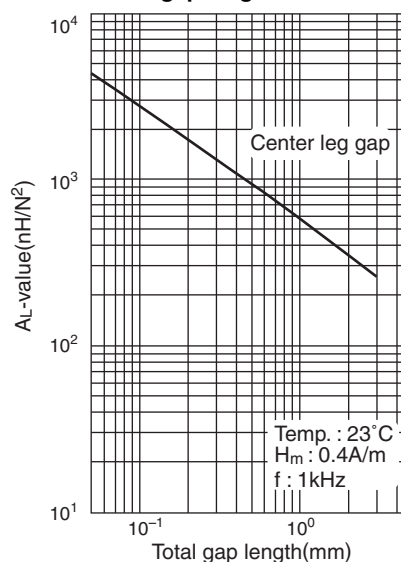

**NI limit vs. AL-value for PC40 EE90X56X16**



When applied magnetic field providing NI to a setting core for arbitrary AL-value, show each NI value when decreased 20% and 40% from initial AL-value.

**AL-value vs. Air gap length for PC40 EE90X56X16**

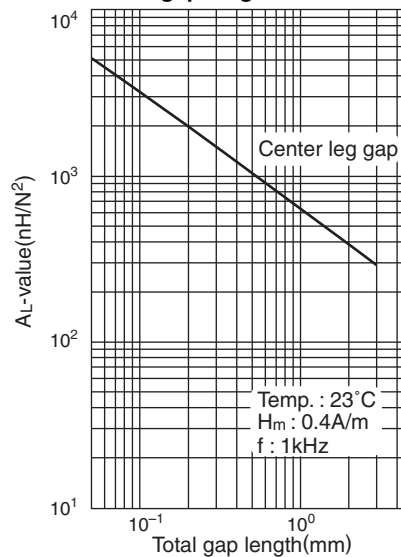

## EI Series

### EI CORE

#### CORE SHAPES AND DIMENSIONS/CHARACTERISTICS



#### PRODUCT IDENTIFICATION

$\frac{PE22}{(1)}$ 
 $\frac{EI}{(2)}$ 
 $\frac{70}{(3)}$ 
 $\times$ 
 $\frac{55}{(4)}$ 
 $\times$ 
 $\frac{19}{(5)}$

- (1) Material name  
 (2) Shape  
 (3) Dimension A  
 (4) Dimension B+l  
 (5) Dimension C

| Part No.         | AL*(nH/N <sup>2</sup> )<br>±25% | Dimensions (mm) |          |          |          |          |          |          |          |         |      |                       |  |  |
|------------------|---------------------------------|-----------------|----------|----------|----------|----------|----------|----------|----------|---------|------|-----------------------|--|--|
|                  |                                 | A               | B+l      | C        | D        | E        | F        | H        | I        | R       | K    | K×F(mm <sup>2</sup> ) |  |  |
| PE22 EI70×55×19  | 5880                            |                 |          |          |          |          |          |          |          |         |      |                       |  |  |
| PC40 EI70×55×19  | 7270                            | 70.0±1.5        | 55.5±1.0 | 19.5±0.5 | 19.5±0.5 | 48.5min. | 35.0±0.5 | 10.0±0.5 | 10.5±0.5 | 0.5max. | 15.3 | 536                   |  |  |
| PE90 EI70×55×19  | 6954                            |                 |          |          |          |          |          |          |          |         |      |                       |  |  |
| PE22 EI70×64×31N | 9585                            |                 |          |          |          |          |          |          |          |         |      |                       |  |  |
| PC40 EI70×64×31N | 11885                           | 70.0±1.5        | 64.4±1.0 | 31.6±0.5 | 22.2±0.5 | 46.3min. | 42.8±0.5 | 11.1±0.5 | 10.4±0.5 | 2.0max. | 12.8 | 548                   |  |  |
| PE90 EI70×64×31N | 11368                           |                 |          |          |          |          |          |          |          |         |      |                       |  |  |

\* Measuring condition: T=23°C, f=1kHz, H<sub>m</sub>=0.4A/m

| Part No.         | Core factor                        |  |                                   |                     |                                   | Weight (g) |
|------------------|------------------------------------|--|-----------------------------------|---------------------|-----------------------------------|------------|
|                  | C <sub>1</sub> (mm <sup>-1</sup> ) | C <sub>2</sub> ×10 <sup>-2</sup> (mm <sup>-3</sup> ) | A <sub>e</sub> (mm <sup>2</sup> ) | ℓ <sub>e</sub> (mm) | V <sub>e</sub> (mm <sup>3</sup> ) |            |
| PE22 EI70×55×19  |                                    |  |                                   |                     |                                   | 266        |
| PC40 EI70×55×19  | 0.33894                            | 0.08693  | 390                               | 132                 | 51520                             | 266        |
| PE90 EI70×55×19  |                                    |  |                                   |                     |                                   | 272        |
| PE22 EI70×64×31N |                                    |  |                                   |                     |                                   | 519        |
| PC40 EI70×64×31N | 0.20929                            | 0.03010  | 695                               | 146                 | 101200                            | 519        |
| PE90 EI70×64×31N |                                    |  |                                   |                     |                                   | 530        |

**EI70X55X19**



**Parameter**

|                                 |                     |                  |         |
|---------------------------------|---------------------|------------------|---------|
| Core constant                   | C1                  | mm <sup>-1</sup> | 0.33894 |
|                                 | C2×10 <sup>-2</sup> | mm <sup>-3</sup> | 0.08693 |
| Effective magnetic path length  | ℓ <sub>e</sub>      | mm               | 132     |
| Effective cross-sectional area  | A <sub>e</sub>      | mm <sup>2</sup>  | 390     |
| Effective core volume           | V <sub>e</sub>      | mm <sup>3</sup>  | 51520   |
| Cross-sectional center leg area | A <sub>c</sub>      | mm <sup>2</sup>  | 380     |
| Minimum cross-sectional area    | A <sub>min.*</sub>  | mm <sup>2</sup>  | 380C*   |
| Winding cross-sectional area    | A <sub>cw</sub>     | mm <sup>2</sup>  | 543     |
| Weight(approx.)                 | g                   |                  | 266     |

\* The symbol followed A min. value shows minimum cross-sectional area part.  
C is center pole part, L is outer pole part, B is the back part.

| Part No.        | AL-value*(nH/N <sup>2</sup> ) | Calculated output power(kW) (forward converter mode) |
|-----------------|-------------------------------|--|
| PE22 EI70X55X19 | 5880±25%                      | 1.4(100kHz)  |
| PC40 EI70X55X19 | 7270±25%                      | 1.6(100kHz)  |

\* AL-value: T=23°C, f=1kHz, H<sub>m</sub>=0.4A/m

**NI limit vs. AL-value for PE22 EI70X55X19**



When applied magnetic field providing NI to a setting core for arbitrary AL-value, show each NI value when decreased 20% and 40% from initial AL-value.

**AL-value vs. Air gap length for PE22 EI70X55X19**



Temp. : 23°C  
H<sub>m</sub> : 0.4A/m  
f : 1kHz

**NI limit vs. AL-value for PC40 EI70X55X19**



When applied magnetic field providing NI to a setting core for arbitrary AL-value, show each NI value when decreased 20% and 40% from initial AL-value.

**AL-value vs. Air gap length for PC40 EI70X55X19**



Temp. : 23°C  
H<sub>m</sub> : 0.4A/m  
f : 1kHz



## DT Series

### DT CORE

#### CORE SHAPES AND DIMENSIONS/CHARACTERISTICS



#### PRODUCT IDENTIFICATION

PE22 DT 138 × 20 × 58  
(1) (2) (3) (4) (5)

- (1) Material name
- (2) Shape
- (3) Dimension A
- (4) Dimension C
- (5) Dimension D

| Part No.                       | AL <sup>*1</sup> (nH/N <sup>2</sup> )<br>±25% | Dimensions (mm) |           |          |          |          |
|--------------------------------|---|-----------------|-----------|----------|----------|----------|
|                                |   | A               | B         | C        | D        | E        |
| PE22 DT138×20×58 <sup>*2</sup> | 6680  |                 |           |          |          |          |
| PC40 DT138×20×58 <sup>*2</sup> | 8540  | 138.0±2.8       | 104.0±2.1 | 20.0±0.4 | 58.0±1.5 | 24.7±0.5 |
| PE90 DT138×20×58 <sup>*2</sup> | 8169  |                 |           |          |          |          |

\*1 Measuring condition: T=23°C, f=1kHz, H<sub>m</sub>=0.4A/m

\*2 DT138×20×58 and DT200×20×102 are both sides grinding machined products.

| Part No.         | Core factor                        |  |                                   |                     |                                   | Weight (g) |
|------------------|------------------------------------|--|-----------------------------------|---------------------|-----------------------------------|------------|
|                  | C <sub>1</sub> (mm <sup>-1</sup> ) | C <sub>2</sub> ×10 <sup>-2</sup> (mm <sup>-3</sup> ) | A <sub>e</sub> (mm <sup>2</sup> ) | l <sub>e</sub> (mm) | V <sub>e</sub> (mm <sup>3</sup> ) |            |
| PE22 DT138×20×58 |                                    |  |                                   |                     |                                   | 1020       |
| PC40 DT138×20×58 | 0.33806                            | 0.04235  | 798                               | 270                 | 215000                            | 1020       |
| PE90 DT138×20×58 |                                    |  |                                   |                     |                                   | 1041       |

## PQ Series

### PQ CORE

#### CORE SHAPES AND DIMENSIONS/CHARACTERISTICS



#### PRODUCT IDENTIFICATION

|      |     |                  |                         |                         |
|------|-----|------------------|-------------------------|-------------------------|
| PE22 | PQ  | $\frac{78}{(3)}$ | $\times \frac{39}{(4)}$ | $\times \frac{42}{(5)}$ |
| (1)  | (2) | (3)              | (4)                     | (5)                     |

- (1) Material name
- (2) Shape
- (3) Dimension A<sub>1</sub>
- (4) Dimension 2D
- (5) Dimension A<sub>2</sub>

### PQ CORE BOBBIN



Bobbin is optional parts.

| Part No.         | AL*(nH/N <sup>2</sup> )<br>±25% | Dimensions (mm) |                |          |          |          |          |          |  |
|------------------|---------------------------------|-----------------|----------------|----------|----------|----------|----------|----------|--|
|                  |                                 | A <sub>1</sub>  | A <sub>2</sub> | B        | ØC       | 2D       | E        | 2H       |  |
| PE22 PQ78×39×42  | 7940                            |                 |                |          |          |          |          |          |  |
| PC40 PQ78×39×42  | 9790                            | 78.5±1.5        | 42.0±0.8       | 69.0min. | 25.5±0.5 | 39.4±0.6 | 60.0min. | 25.8±1.0 |  |
| PE90 PQ78×39×42  | 9364                            |                 |                |          |          |          |          |          |  |
| PE22 PQ107×87×70 | 14570                           |                 |                |          |          |          |          |          |  |
| PC40 PQ107×87×70 | 18210                           | 107.0±2.0       | 70.0±1.5       | 93.7min. | 41.0±1.0 | 87.0±1.5 | 72.5min. | 56.0±1.5 |  |
| PE90 PQ107×87×70 | 17418                           |                 |                |          |          |          |          |          |  |

\* Measuring condition: T=23°C, f=1kHz, H<sub>m</sub>=0.4A/m

| Part No.         | Core factor                        |  |                                   |                     |                                   |      | Weight(g) |
|------------------|------------------------------------|--|-----------------------------------|---------------------|-----------------------------------|------|-----------|
|                  | C <sub>1</sub> (mm <sup>-1</sup> ) | C <sub>2</sub> ×10 <sup>-2</sup> (mm <sup>-3</sup> ) | A <sub>e</sub> (mm <sup>2</sup> ) | ℓ <sub>e</sub> (mm) | V <sub>e</sub> (mm <sup>3</sup> ) |      |           |
| PE22 PQ78×39×42  |                                    |  |                                   |                     |                                   | 304  |           |
| PC40 PQ78×39×42  | 0.24730                            | 0.051530   | 480                               | 119                 | 56900                             | 304  |           |
| PE90 PQ78×39×42  |                                    |  |                                   |                     |                                   | 310  |           |
| PE22 PQ107×87×70 |                                    |  |                                   |                     |                                   | 1560 |           |
| PC40 PQ107×87×70 | 0.14260                            | 0.009989   | 1428                              | 204                 | 290600                            | 1560 |           |
| PE90 PQ107×87×70 |                                    |  |                                   |                     |                                   | 1593 |           |

### PQ CORE BOBBIN

| Part No. | Dimensions (mm) |          |          |          |          |          |           |          | Cross-sectional winding area<br>A <sub>w</sub> (mm <sup>2</sup> ) | Average winding length<br>ℓ <sub>w</sub> (mm) | Material |
|----------|-----------------|----------|----------|----------|----------|----------|-----------|----------|---|---|----------|
|          | ØA              | ØB       | ØC       | D        | E        | X        | Y         | Z        |   |   |          |
| BPQ78    | 67.8±0.3        | 30.2±0.5 | 26.8±0.5 | 23.5±2.0 | 20.0±2.0 | 57.5±0.5 | 78.0±0.5  | 31.0±2.0 | 377   | 154   | PBT      |
| BPQ107   | 92.5±0.5        | 42.7±0.5 | 46.7±0.5 | 53.5±2.5 | 49.5±3.0 | 69.5±0.5 | 100.0±0.5 | 71.0±2.5 | 1140  | 218   | PBT      |

• Soldering condition: 350°C max./2s

**PQ78X39X42**

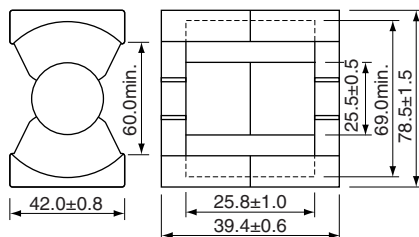

Dimensions in mm

**Parameter**

|                                 |                     |                  |         |
|---------------------------------|---------------------|------------------|---------|
| Core constant                   | C1                  | mm <sup>-1</sup> | 0.2473  |
|                                 | C2×10 <sup>-2</sup> | mm <sup>-3</sup> | 0.05153 |
| Effective magnetic path length  | ℓ <sub>e</sub>      | mm               | 119     |
| Effective cross-sectional area  | A <sub>e</sub>      | mm <sup>2</sup>  | 480     |
| Effective core volume           | V <sub>e</sub>      | mm <sup>3</sup>  | 56900   |
| Cross-sectional center leg area | A <sub>c</sub>      | mm <sup>2</sup>  | 510     |
| Minimum cross-sectional area    | A <sub>min.*</sub>  | mm <sup>2</sup>  | 510C*   |
| Winding cross-sectional area    | A <sub>cw</sub>     | mm <sup>2</sup>  | 570     |
| Weight(approx.)                 | g                   |                  | 304     |

\* The symbol followed A min. value shows minimum cross-sectional area part.  
C is center pole part, L is outer pole part, B is the back part.

| Part No.        | AL-value*(nH/N <sup>2</sup> ) | Calculated output power(kW) (forward converter mode) |
|-----------------|-------------------------------|--|
| PE22 PQ78X39X42 | 7940±25%                      | 1.6(100kHz)  |
| PC40 PQ78X39X42 | 9790±25%                      | 1.7(100kHz)  |

\* AL-value: T=23°C, f=1kHz, H<sub>m</sub>=0.4A/m

• Available customize core like this. Please specify when ordering.

**NI limit vs. AL-value for PE22 PQ78X39X42**

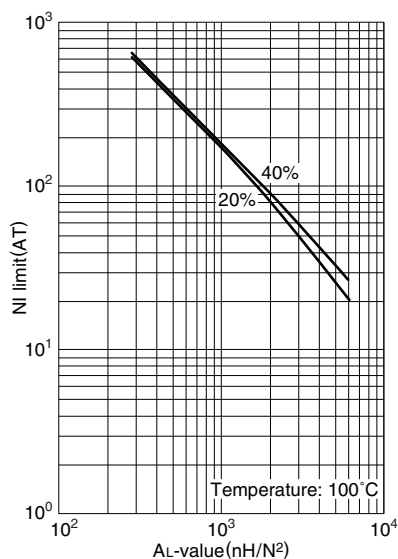

When applied magnetic field providing NI to a setting core for arbitrary AL-value, show each NI value when decreased 20% and 40% from initial AL-value.

**AL-value vs. Air gap length for PE22 PQ78X39X42**



**NI limit vs. AL-value for PC40 PQ78X39X42**

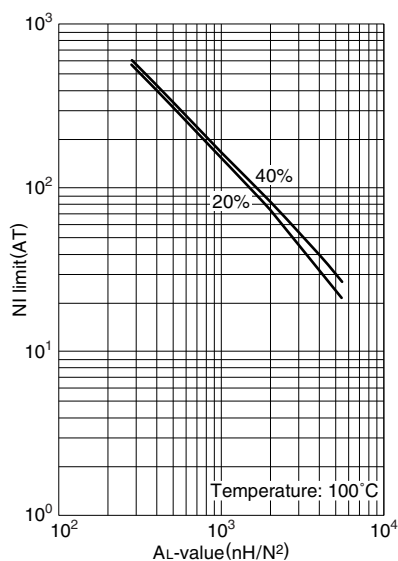

When applied magnetic field providing NI to a setting core for arbitrary AL-value, show each NI value when decreased 20% and 40% from initial AL-value.

**AL-value vs. Air gap length for PC40 PQ78X39X42**



**PQ107X87X70**



**Parameter**

|                                 |                     |                  |          |
|---------------------------------|---------------------|------------------|----------|
| Core constant                   | C1                  | mm <sup>-1</sup> | 0.1426   |
|                                 | C2×10 <sup>-2</sup> | mm <sup>-3</sup> | 0.009989 |
| Effective magnetic path length  | ℓ <sub>e</sub>      | mm               | 204      |
| Effective cross-sectional area  | A <sub>e</sub>      | mm <sup>2</sup>  | 1428     |
| Effective core volume           | V <sub>e</sub>      | mm <sup>3</sup>  | 290600   |
| Cross-sectional center leg area | A <sub>c</sub>      | mm <sup>2</sup>  | 1320     |
| Minimum cross-sectional area    | A <sub>min.*</sub>  | mm <sup>2</sup>  | 1320C*   |
| Winding cross-sectional area    | A <sub>cw</sub>     | mm <sup>2</sup>  | 1540     |
| Weight(approx.)                 | g                   |                  | 1560     |

\* The symbol followed A min. value shows minimum cross-sectional area part.  
C is center pole part, L is outer pole part, B is the back part.

| Part No.         | AL-value*(nH/N <sup>2</sup> ) | Calculated output power(kW) (forward converter mode) |
|------------------|-------------------------------|--|
| PE22 PQ107X87X70 | 14570±25%                     | 8.3(100kHz)  |
| PC40 PQ107X87X70 | 18210±25%                     | 9.0(100kHz)  |

\* AL-value: T=23°C, f=1kHz, H<sub>m</sub>=0.4A/m

• Available customize core like this. Please specify when ordering.

**NI limit vs. AL-value for PE22 PQ107X87X70**



When applied magnetic field providing NI to a setting core for arbitrary AL-value, show each NI value when decreased 20% and 40% from initial AL-value.

**AL-value vs. Air gap length for PE22 PQ107X87X70**



**NI limit vs. AL-value for PC40 PQ107X87X70**



When applied magnetic field providing NI to a setting core for arbitrary AL-value, show each NI value when decreased 20% and 40% from initial AL-value.

**AL-value vs. Air gap length for PC40 PQ107X87X70**

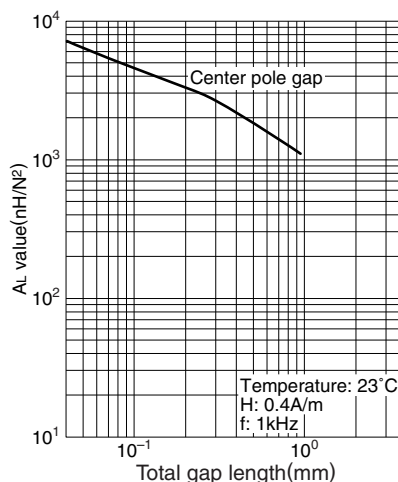

## SP Series

### SP CORE

#### CORE SHAPES AND DIMENSIONS/CHARACTERISTICS

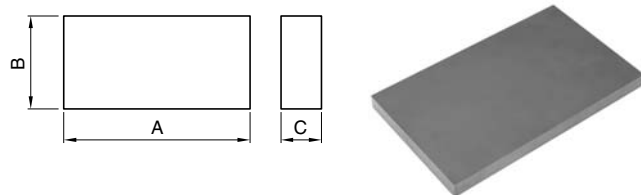

#### PRODUCT IDENTIFICATION

PE22 SP 135 × 65 × 20  
 (1) (2) (3) (4) (5)

- (1) Material name
- (2) Shape
- (3) Dimension A
- (4) Dimension B
- (5) Dimension C

| Part No.         | Dimensions (mm) |          |          |
|------------------|-----------------|----------|----------|
|                  | A               | B        | C        |
| PE22 SP59×19×5   |                 |          |          |
| PC40 SP59×19×5   | 59.0±1.0        | 19.5±0.5 | 5.0±0.5  |
| PE90 SP59×19×5   |                 |          |          |
| PE22 SP65×10×5   |                 |          |          |
| PC40 SP65×10×5   | 65.0±1.5        | 10.0±0.5 | 5.0±0.5  |
| PE90 SP65×10×5   |                 |          |          |
| PE22 SP79×70×10  |                 |          |          |
| PC40 SP79×70×10  | 79.0±1.5        | 70.0±1.5 | 10.0±0.5 |
| PE90 SP79×70×10  |                 |          |          |
| PE22 SP135×65×20 |                 |          |          |
| PC40 SP135×65×20 | 135.0±2.5       | 65.0±1.5 | 20.0±0.5 |
| PE90 SP135×65×20 |                 |          |          |



Компания «ЭлектроПласт» предлагает заключение долгосрочных отношений при поставках импортных электронных компонентов на взаимовыгодных условиях!

Наши преимущества:

- Оперативные поставки широкого спектра электронных компонентов отечественного и импортного производства напрямую от производителей и с крупнейших мировых складов;
- Поставка более 17-ти миллионов наименований электронных компонентов;
- Поставка сложных, дефицитных, либо снятых с производства позиций;
- Оперативные сроки поставки под заказ (от 5 рабочих дней);
- Экспресс доставка в любую точку России;
- Техническая поддержка проекта, помощь в подборе аналогов, поставка прототипов;
- Система менеджмента качества сертифицирована по Международному стандарту ISO 9001;
- Лицензия ФСБ на осуществление работ с использованием сведений, составляющих государственную тайну;
- Поставка специализированных компонентов (Xilinx, Altera, Analog Devices, Intersil, Interpoint, Microsemi, Aeroflex, Peregrine, Syfer, Eurofarad, Texas Instrument, Miteq, Cobham, E2V, MA-COM, Hittite, Mini-Circuits, General Dynamics и др.);

Помимо этого, одним из направлений компании «ЭлектроПласт» является направление «Источники питания». Мы предлагаем Вам помощь Конструкторского отдела:

- Подбор оптимального решения, техническое обоснование при выборе компонента;
- Подбор аналогов;
- Консультации по применению компонента;
- Поставка образцов и прототипов;
- Техническая поддержка проекта;
- Защита от снятия компонента с производства.



#### Как с нами связаться

**Телефон:** 8 (812) 309 58 32 (многоканальный)

**Факс:** 8 (812) 320-02-42

**Электронная почта:** [org@eplast1.ru](mailto:org@eplast1.ru)

**Адрес:** 198099, г. Санкт-Петербург, ул. Калинина, дом 2, корпус 4, литера А.