

**RoHS Qxx10xx & Qxx10xHx Series**



**Description**

10 Amp bi-directional solid state switch series is designed for AC switching and phase control applications such as motor speed and temperature modulation controls, lighting controls, and static switching relays.

Standard type devices normally operate in Quadrants I & III triggered from AC line.

**Features & Benefits**

- RoHS Compliant
- Glass – passivated junctions
- Voltage capability up to 1000 V
- Surge capability up to 120 A
- Electrically isolated package "L - Package" and UL recognized for 2500Vrms
- Solid-state switching eliminates arcing or contact bounce that create voltage transients
- No contacts to wear out from reaction of switching events
- Restricted (or limited) RFI generation, depending on activation point sine wave

**Agency Approval**

| Agency | Agency File Number |
|--------|--------------------|
|        | L Package: E71639  |

**Main Features**

| Symbol            | Value       | Unit |
|-------------------|-------------|------|
| $I_{T(RMS)}$      | 10          | A    |
| $V_{DRM}/V_{RRM}$ | 400 to 1000 | V    |
| $I_{GT(Q1)}$      | 25 to 50    | mA   |

**Schematic Symbol**

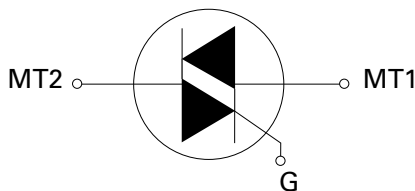

**Applications**

Alternistor type devices are used in applications requiring high commutation performance such as controlling inductive loads. Isolated packages are offered with internal construction, having the case or mounting tab electrically isolated from the semiconductor chip.

**Absolute Maximum Ratings — Standard Triac**

| Symbol       | Parameter                                                                                              | Value                                              | Unit                      |            |                        |
|--------------|--------------------------------------------------------------------------------------------------------|----------------------------------------------------|---------------------------|------------|------------------------|
| $I_{T(RMS)}$ | RMS on-state current (full sine wave)                                                                  | Qxx10Ry/<br>Qxx10Ny                                | $T_C = 95^\circ\text{C}$  | 10         | A                      |
|              |                                                                                                        | Qxx10Ly                                            | $T_C = 90^\circ\text{C}$  |            |                        |
| $I_{TSM}$    | Non repetitive surge peak on-state current<br>(full cycle, $T_J$ initial = $25^\circ\text{C}$ )        | f = 50 Hz                                          | t = 20 ms                 | 100        | A                      |
|              |                                                                                                        | f = 60 Hz                                          | t = 16.7 ms               | 120        |                        |
| $I^2t$       | $I^2t$ Value for fusing                                                                                | $t_p = 8.3$ ms                                     |                           | 60         | $\text{A}^2\text{s}$   |
| di/dt        | Critical rate of rise of on-state current<br>$I_G = 200\text{mA}$ with $\leq 0.1\mu\text{s}$ rise time | f = 120 Hz                                         | $T_J = 125^\circ\text{C}$ | 70         | $\text{A}/\mu\text{s}$ |
| $I_{GTM}$    | Peak gate trigger current                                                                              | $t_p \leq 10 \mu\text{s}$<br>$I_{GT} \leq I_{GTM}$ | $T_J = 125^\circ\text{C}$ | 1.8        | A                      |
| $P_{G(AV)}$  | Average gate power dissipation                                                                         |                                                    | $T_J = 125^\circ\text{C}$ | 0.5        | W                      |
| $T_{stg}$    | Storage temperature range                                                                              |                                                    |                           | -40 to 150 | $^\circ\text{C}$       |
| $T_J$        | Operating junction temperature range                                                                   |                                                    |                           | -40 to 125 | $^\circ\text{C}$       |

**Absolute Maximum Ratings — Alternistor Triac (3 Quadrants)**

| Symbol       | Parameter                                                                                       | Value                                              | Unit                      |            |                        |
|--------------|-------------------------------------------------------------------------------------------------|----------------------------------------------------|---------------------------|------------|------------------------|
| $I_{T(RMS)}$ | RMS on-state current (full sine wave)                                                           | Qxx10LHy                                           | $T_C = 90^\circ\text{C}$  | 10         | A                      |
|              |                                                                                                 | Qxx10RHy/<br>Qxx10NHy                              | $T_C = 95^\circ\text{C}$  |            |                        |
| $I_{TSM}$    | Non repetitive surge peak on-state current<br>(full cycle, $T_J$ initial = $25^\circ\text{C}$ ) | f = 50 Hz                                          | t = 20 ms                 | 110        | A                      |
|              |                                                                                                 | f = 60 Hz                                          | t = 16.7 ms               | 120        |                        |
| $I^2t$       | $I^2t$ Value for fusing                                                                         | $t_p = 8.3$ ms                                     |                           | 60         | $\text{A}^2\text{s}$   |
| di/dt        | Critical rate of rise of on-state current                                                       | f = 120 Hz                                         | $T_J = 125^\circ\text{C}$ | 70         | $\text{A}/\mu\text{s}$ |
| $I_{GTM}$    | Peak gate trigger current                                                                       | $t_p \leq 10 \mu\text{s}$<br>$I_{GT} \leq I_{GTM}$ | $T_J = 125^\circ\text{C}$ | 2.0        | A                      |
| $P_{G(AV)}$  | Average gate power dissipation                                                                  |                                                    | $T_J = 125^\circ\text{C}$ | 0.5        | W                      |
| $T_{stg}$    | Storage temperature range                                                                       |                                                    |                           | -40 to 150 | $^\circ\text{C}$       |
| $T_J$        | Operating junction temperature range                                                            |                                                    |                           | -40 to 125 | $^\circ\text{C}$       |

**Electrical Characteristics ( $T_J = 25^\circ\text{C}$ , unless otherwise specified) — Standard Triac**

| Symbol   | Test Conditions                                                         | Quadrant           | Qxx10x4  | Qxx10x5        | Unit             |
|----------|-------------------------------------------------------------------------|--------------------|----------|----------------|------------------|
| $I_{GT}$ | $V_D = 12\text{V}$ $R_L = 60 \Omega$                                    | I – II – III<br>IV | 25<br>50 | 50<br>75 (TYP) | mA               |
| $V_{GT}$ |                                                                         | I – II – III       | 1.3      |                | V                |
| $V_{GD}$ | $V_D = V_{DRM}$ $R_L = 3.3 \text{k}\Omega$ $T_J = 125^\circ\text{C}$    | ALL                | 0.2      |                | V                |
| $I_H$    | $I_T = 200\text{mA}$                                                    | MAX.               | 35       | 50             | mA               |
| dv/dt    | $V_D = V_{DRM}$ Gate Open $T_J = 125^\circ\text{C}$                     | 400V               | 150      | 225            | V/ $\mu\text{s}$ |
|          |                                                                         | 600V               | 100      | 200            |                  |
|          |                                                                         | 800V               | 75       | 175            |                  |
|          | $V_D = V_{DRM}$ Gate Open $T_J = 100^\circ\text{C}$                     | 1000V              | 50       | 150            |                  |
| (dv/dt)c | (di/dt)c = 5.4 A/ms $T_J = 125^\circ\text{C}$                           | TYP.               | 2        | 4              | V/ $\mu\text{s}$ |
| $t_{gt}$ | $I_G = 2 \times I_{GT}$ PW = 15 $\mu\text{s}$ $I_T = 14.1 \text{A(pk)}$ | TYP.               | 3.0      | 3.0            | $\mu\text{s}$    |

Note: xx = voltage, x = package, y = sensitivity

**Electrical Characteristics ( $T_J = 25^\circ\text{C}$ , unless otherwise specified) — Alternistor Triac (3 Quadrants)**

| Symbol     | Test Conditions                                                           | Quadrant     |      | Value | Unit             |
|------------|---------------------------------------------------------------------------|--------------|------|-------|------------------|
| $I_{GT}$   | $V_D = 12\text{V}$ $R_L = 60\ \Omega$                                     | I – II – III | MAX. | 50    | mA               |
| $V_{GT}$   |                                                                           | I – II – III | MAX. | 1.3   | V                |
| $V_{GD}$   | $V_D = V_{DRM}$ $R_L = 3.3\ \text{k}\Omega$ $T_J = 125^\circ\text{C}$     | I – II – III | MIN. | 0.2   | V                |
| $I_H$      | $I_T = 100\text{mA}$                                                      |              | MAX. | 50    | mA               |
| $dv/dt$    | $V_D = V_{DRM}$ Gate Open $T_J = 125^\circ\text{C}$                       | 400V         | MIN. | 750   | V/ $\mu\text{s}$ |
|            |                                                                           | 600V         |      | 650   |                  |
|            |                                                                           | 800V         |      | 500   |                  |
|            | $V_D = V_{DRM}$ Gate Open $T_J = 100^\circ\text{C}$                       | 1000V        |      | 300   |                  |
| $(dv/dt)c$ | $(di/dt)c = 5.4\ \text{A/ms}$ $T_J = 125^\circ\text{C}$                   |              | TYP. | 30    | V/ $\mu\text{s}$ |
| $t_{gt}$   | $I_G = 2 \times I_{GT}$ $PW = 15\ \mu\text{s}$ $I_T = 14.1\ \text{A(pk)}$ |              | TYP. | 4.0   | $\mu\text{s}$    |

**Static Characteristics**

| Symbol                 | Test Conditions                                  |                           | Value      | Unit |               |
|------------------------|--------------------------------------------------|---------------------------|------------|------|---------------|
| $V_{TM}$               | $I_{TM} = 14.1\text{A}$ $t_p = 380\ \mu\text{s}$ |                           | MAX.       | 1.60 | V             |
| $I_{DRM}$<br>$I_{RRM}$ | $V_{DRM} = V_{RRM}$                              | $T_J = 25^\circ\text{C}$  | 400 - 600V | 10   | $\mu\text{A}$ |
|                        |                                                  | $T_J = 125^\circ\text{C}$ | 400 - 800V | 2    | mA            |
|                        |                                                  | $T_J = 100^\circ\text{C}$ | 1000V      | 3    |               |

**Thermal Resistances**

| Symbol            | Parameter                |                       | Value | Unit               |
|-------------------|--------------------------|-----------------------|-------|--------------------|
| $R_{\theta(J-C)}$ | Junction to case (AC)    | Qxx10Ryy/<br>Qxx10Nyy | 1.3   | $^\circ\text{C/W}$ |
|                   |                          | Qxx10Lyy              | 2.6   |                    |
| $R_{\theta(J-A)}$ | Junction to ambient (AC) | Qxx10Ryy              | 45    | $^\circ\text{C/W}$ |
|                   |                          | Qxx10Lyy              | 50    |                    |

Note: xx = voltage, x = package, y = sensitivity, yy = type & sensitivity

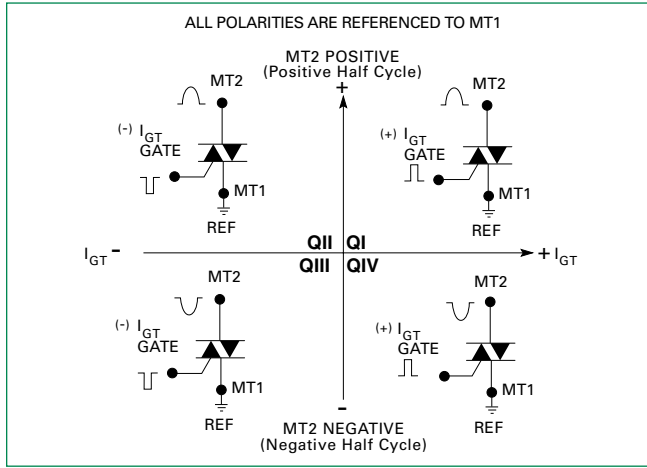
**Figure 1: Definition of Quadrants**

Note: Alternistors will not operate in QIV

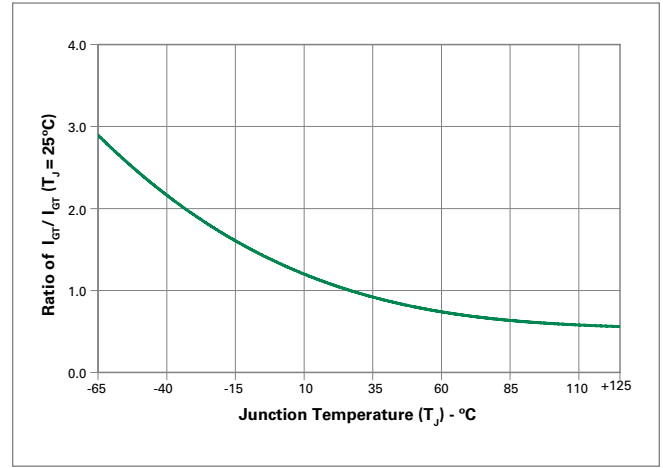
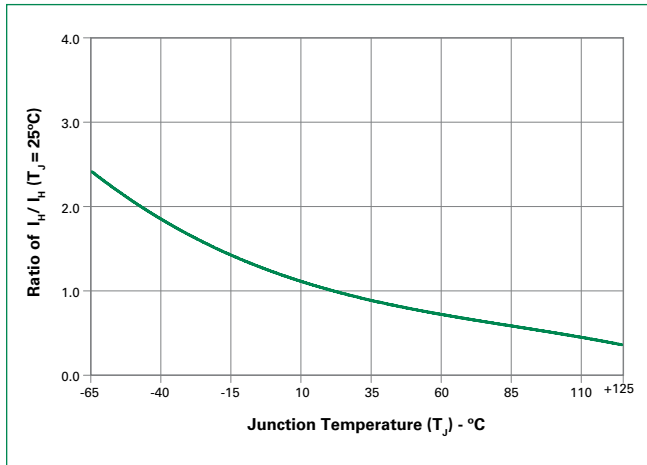
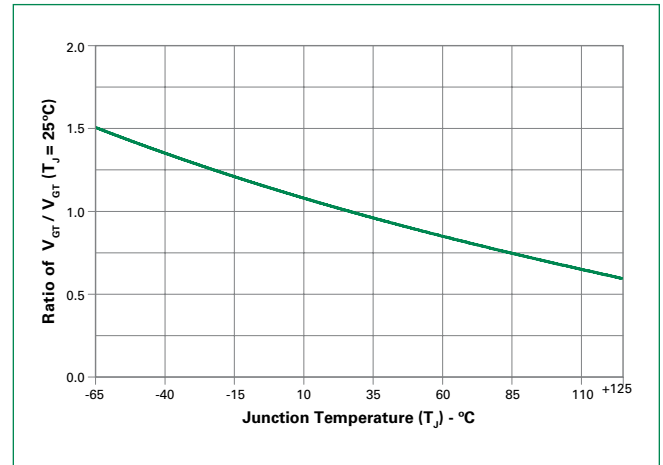
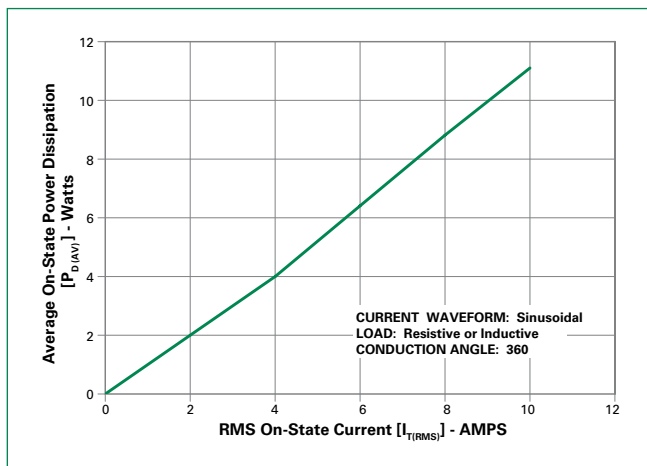
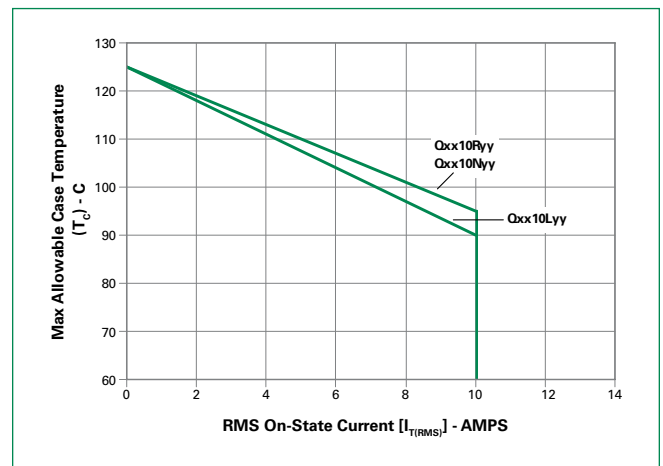
**Figure 2: Normalized DC Gate Trigger Current for All Quadrants vs. Junction Temperature**

**Figure 3: Normalized DC Holding Current vs. Junction Temperature**

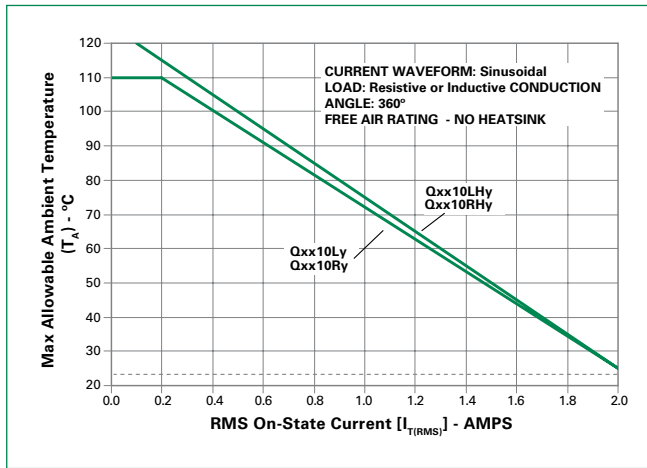
**Figure 4: Normalized DC Gate Trigger Voltage for All Quadrants vs. Junction Temperature**

**Figure 5: Power Dissipation (Typical) vs. RMS On-State Current**

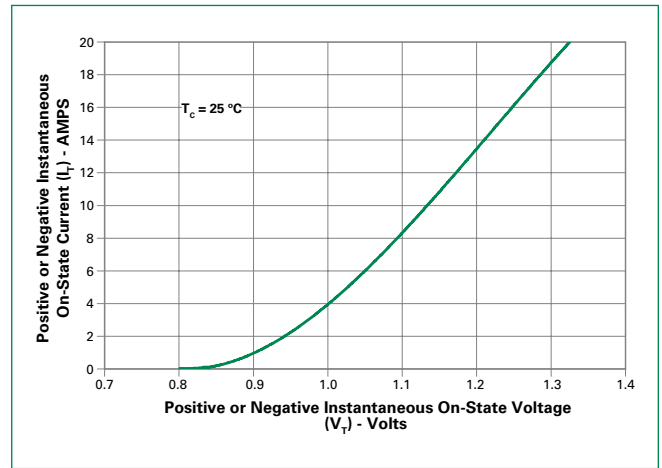
**Figure 6: Maximum Allowable Case Temperature vs. On-State Current**

**Figure 7: Maximum Allowable Ambient Temperature vs. On-State Current**



**Figure 8: On-State Current vs. On-State Voltage (Typical)**



**Figure 9: Surge Peak On-State Current vs. Number of Cycles**

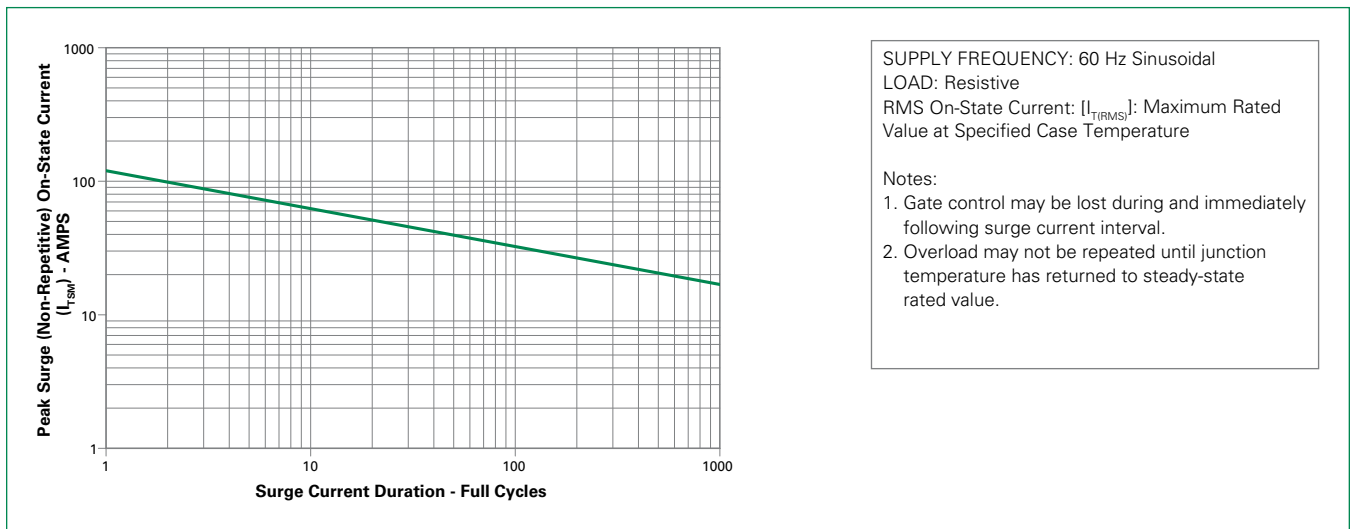

### Soldering Parameters

|                                                        |                                    |                         |
|--------------------------------------------------------|------------------------------------|-------------------------|
| Reflow Condition                                       |                                    | Pb – Free assembly      |
| Pre Heat                                               | - Temperature Min ( $T_{s(min)}$ ) | 150°C                   |
|                                                        | - Temperature Max ( $T_{s(max)}$ ) | 200°C                   |
|                                                        | - Time (min to max) ( $t_s$ )      | 60 – 180 secs           |
| Average ramp up rate (Liquidus Temp ( $T_L$ ) to peak) |                                    | 5°C/second max          |
| $T_{s(max)}$ to $T_L$ - Ramp-up Rate                   |                                    | 5°C/second max          |
| Reflow                                                 | - Temperature ( $T_L$ ) (Liquidus) | 217°C                   |
|                                                        | - Temperature ( $t_L$ )            | 60 – 150 seconds        |
| Peak Temperature ( $T_p$ )                             |                                    | 260 <sup>+0/-5</sup> °C |
| Time within 5°C of actual peak Temperature ( $t_p$ )   |                                    | 20 – 40 seconds         |
| Ramp-down Rate                                         |                                    | 5°C/second max          |
| Time 25°C to peak Temperature ( $T_p$ )                |                                    | 8 minutes Max.          |
| Do not exceed                                          |                                    | 280°C                   |



### Physical Specifications

|                          |                                                                |
|--------------------------|----------------------------------------------------------------|
| <b>Terminal Finish</b>   | 100% Matte Tin-plated                                          |
| <b>Body Material</b>     | UL recognized epoxy meeting flammability classification 94V-0. |
| <b>Terminal Material</b> | Copper Alloy                                                   |

### Design Considerations

Careful selection of the correct device for the application's operating parameters and environment will go a long way toward extending the operating life of the Thyristor. Good design practice should limit the maximum continuous current through the main terminals to 75% of the device rating. Other ways to ensure long life for a power discrete semiconductor are proper heat sinking and selection of voltage ratings for worst case conditions. Overheating, overvoltage (including dv/dt), and surge currents are the main killers of semiconductors. Correct mounting, soldering, and forming of the leads also help protect against component damage.

### Environmental Specifications

| Test                             | Specifications and Conditions                                                                                                     |
|----------------------------------|-----------------------------------------------------------------------------------------------------------------------------------|
| <b>AC Blocking</b>               | MIL-STD-750, M-1040, Cond A Applied Peak AC voltage @ 125°C for 1008 hours                                                        |
| <b>Temperature Cycling</b>       | MIL-STD-750, M-1051, 100 cycles; -40°C to +150°C, 15-min dwell-time                                                               |
| <b>Temperature/Humidity</b>      | EIA/JEDEC, JESD22-A101 1008 hours; 320V - DC: 85°C; 85% rel humidity                                                              |
| <b>High Temp Storage</b>         | MIL-STD-750, M-1031, 1008 hours; 150°C                                                                                            |
| <b>Low-Temp Storage</b>          | 1008 hours; -40°C                                                                                                                 |
| <b>Thermal Shock</b>             | MIL-STD-750, M-1056 10 cycles; 0°C to 100°C; 5-min dwell time at each temperature; 10 sec (max) transfer time between temperature |
| <b>Autoclave</b>                 | EIA/JEDEC, JESD22-A102 168 hours (121°C at 2 ATMs) and 100% R/H                                                                   |
| <b>Resistance to Solder Heat</b> | MIL-STD-750 Method 2031                                                                                                           |
| <b>Solderability</b>             | ANSI/J-STD-002, category 3 Test A                                                                                                 |
| <b>Lead Bend</b>                 | MIL-STD-750, M-2036 Cond E                                                                                                        |

**Dimensions — TO-220AB (R-Package) — Non-Isolated Mounting Tab Common with Center Lead**



Note: Maximum torque to be applied to mounting tab is 8 in-lbs. (0.904 Nm).

| Dimension | Inches |       | Millimeters |       |
|-----------|--------|-------|-------------|-------|
|           | Min    | Max   | Min         | Max   |
| A         | 0.380  | 0.420 | 9.65        | 10.67 |
| B         | 0.105  | 0.115 | 2.67        | 2.92  |
| C         | 0.230  | 0.250 | 5.84        | 6.35  |
| D         | 0.590  | 0.620 | 14.99       | 15.75 |
| E         | 0.142  | 0.147 | 3.61        | 3.73  |
| F         | 0.110  | 0.130 | 2.79        | 3.30  |
| G         | 0.540  | 0.575 | 13.72       | 14.61 |
| H         | 0.025  | 0.035 | 0.64        | 0.89  |
| J         | 0.195  | 0.205 | 4.95        | 5.21  |
| K         | 0.095  | 0.105 | 2.41        | 2.67  |
| L         | 0.060  | 0.075 | 1.52        | 1.91  |
| M         | 0.085  | 0.095 | 2.16        | 2.41  |
| N         | 0.018  | 0.024 | 0.46        | 0.61  |
| O         | 0.178  | 0.188 | 4.52        | 4.78  |
| P         | 0.045  | 0.060 | 1.14        | 1.52  |
| R         | 0.038  | 0.048 | 0.965       | 1.22  |

**Dimensions — TO-220AB (L-Package) — Isolated Mounting Tab**



Note: Maximum torque to be applied to mounting tab is 8 in-lbs. (0.904 Nm).

| Dimension | Inches |       | Millimeters |       |
|-----------|--------|-------|-------------|-------|
|           | Min    | Max   | Min         | Max   |
| A         | 0.380  | 0.420 | 9.65        | 10.67 |
| B         | 0.105  | 0.115 | 2.67        | 2.92  |
| C         | 0.230  | 0.250 | 5.84        | 6.35  |
| D         | 0.590  | 0.620 | 14.99       | 15.75 |
| E         | 0.142  | 0.147 | 3.61        | 3.73  |
| F         | 0.110  | 0.130 | 2.79        | 3.30  |
| G         | 0.540  | 0.575 | 13.72       | 14.61 |
| H         | 0.025  | 0.035 | 0.64        | 0.89  |
| J         | 0.195  | 0.205 | 4.95        | 5.21  |
| K         | 0.095  | 0.105 | 2.41        | 2.67  |
| L         | 0.060  | 0.075 | 1.52        | 1.91  |
| M         | 0.085  | 0.095 | 2.16        | 2.41  |
| N         | 0.018  | 0.024 | 0.46        | 0.61  |
| O         | 0.178  | 0.188 | 4.52        | 4.78  |
| P         | 0.045  | 0.060 | 1.14        | 1.52  |
| R         | 0.038  | 0.048 | 0.965       | 1.22  |

**Dimensions — TO-263AA (N-Package) — D<sup>2</sup>-PAK Surface Mount**

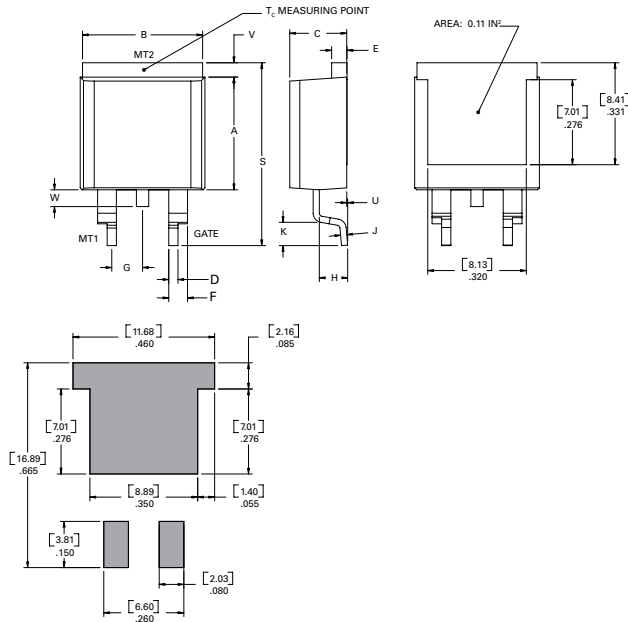

| Dimension | Inches |       | Millimeters |       |
|-----------|--------|-------|-------------|-------|
|           | Min    | Max   | Min         | Max   |
| A         | 0.360  | 0.370 | 9.14        | 9.40  |
| B         | 0.380  | 0.420 | 9.65        | 10.67 |
| C         | 0.178  | 0.188 | 4.52        | 4.78  |
| D         | 0.025  | 0.035 | 0.64        | 0.89  |
| E         | 0.045  | 0.060 | 1.14        | 1.52  |
| F         | 0.060  | 0.075 | 1.52        | 1.91  |
| G         | 0.095  | 0.105 | 2.41        | 2.67  |
| H         | 0.092  | 0.102 | 2.34        | 2.59  |
| J         | 0.018  | 0.024 | 0.46        | 0.61  |
| K         | 0.090  | 0.110 | 2.29        | 2.79  |
| S         | 0.590  | 0.625 | 14.99       | 15.88 |
| V         | 0.035  | 0.045 | 0.89        | 1.14  |
| U         | 0.002  | 0.010 | 0.05        | 0.25  |
| W         | 0.040  | 0.070 | 1.016       | 1.78  |

**Product Selector**

| Part Number | Voltage (xx) |      |      |       | Gate Sensitivity Quadrants |       | Type              | Package                    |
|-------------|--------------|------|------|-------|----------------------------|-------|-------------------|----------------------------|
|             | 400V         | 600V | 800V | 1000V | I – II – III               | IV    |                   |                            |
| Qxx10L4     | X            | X    | X    | X     | 25 mA                      | 50 mA | Standard Triac    | TO-220L                    |
| Qxx10R4     | X            | X    | X    | X     | 25 mA                      | 50 mA | Standard Triac    | TO-220R                    |
| Qxx10N4     | X            | X    | X    | X     | 25 mA                      | 50 mA | Standard Triac    | TO-263 D <sup>2</sup> -PAK |
| Qxx10L5     | X            | X    | X    | X     | 50 mA                      |       | Standard Triac    | TO-220L                    |
| Qxx10R5     | X            | X    | X    | X     | 50 mA                      |       | Standard Triac    | TO-220R                    |
| Qxx10N5     | X            | X    | X    | X     | 50 mA                      |       | Standard Triac    | TO-263 D <sup>2</sup> -PAK |
| Qxx10LH5    | X            | X    | X    | X     | 50 mA                      |       | Alternistor Triac | TO-220L                    |
| Qxx10RH5    | X            | X    | X    | X     | 50 mA                      |       | Alternistor Triac | TO-220R                    |
| Qxx10NH5    | X            | X    | X    | X     | 50 mA                      |       | Alternistor Triac | TO-263 D <sup>2</sup> -PAK |

**Packing Options**

| Part Number  | Marking    | Weight | Packing Mode     | Base Quantity     |
|--------------|------------|--------|------------------|-------------------|
| Qxx10L/Ryy   | Qxx10L/Ryy | 2.2 g  | Bulk             | 500               |
| Qxx10L/RyyTP | Qxx10L/Ryy | 2.2 g  | Tube Pack        | 500 (50 per tube) |
| Qxx10NyyTP   | Qxx10Nyy   | 1.6 g  | Tube             | 500 (50 per tube) |
| Qxx10NyyRP   | Qxx10Nyy   | 1.6 g  | Embossed Carrier | 500               |

Note: xx = voltage, yy = type & sensitivity



**TO-263 Embossed Carrier Reel Pack (RP) Specifications**

Meets all EIA-481-2 Standards

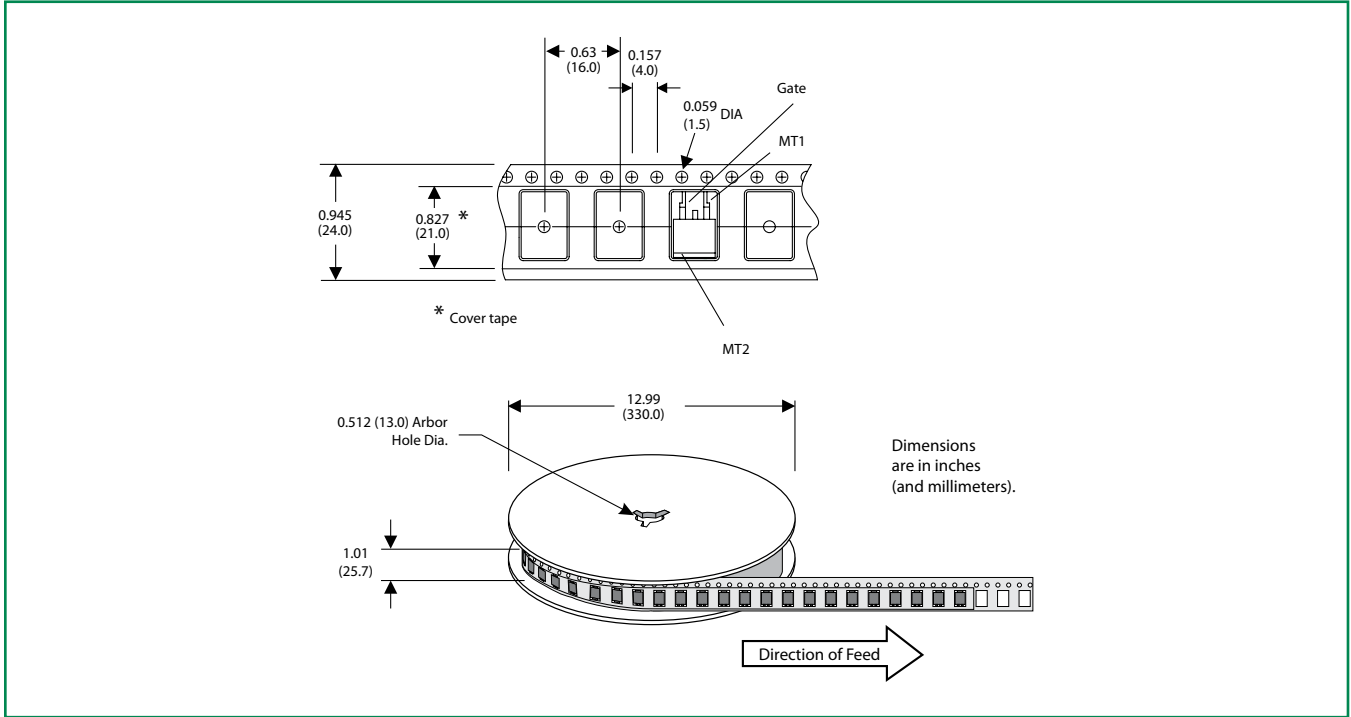

**Part Numbering System**

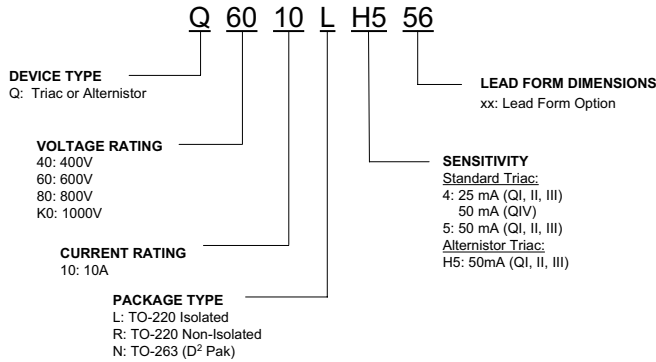

**Part Marking System**

TO-220 AB – (R Package)  
TO-263 AB – (N Package)



TO-220 AB – (L Package)



Компания «ЭлектроПласт» предлагает заключение долгосрочных отношений при поставках импортных электронных компонентов на взаимовыгодных условиях!

Наши преимущества:

- Оперативные поставки широкого спектра электронных компонентов отечественного и импортного производства напрямую от производителей и с крупнейших мировых складов;
- Поставка более 17-ти миллионов наименований электронных компонентов;
- Поставка сложных, дефицитных, либо снятых с производства позиций;
- Оперативные сроки поставки под заказ (от 5 рабочих дней);
- Экспресс доставка в любую точку России;
- Техническая поддержка проекта, помощь в подборе аналогов, поставка прототипов;
- Система менеджмента качества сертифицирована по Международному стандарту ISO 9001;
- Лицензия ФСБ на осуществление работ с использованием сведений, составляющих государственную тайну;
- Поставка специализированных компонентов (Xilinx, Altera, Analog Devices, Intersil, Interpoint, Microsemi, Aeroflex, Peregrine, Syfer, Eurofarad, Texas Instrument, Miteq, Cobham, E2V, MA-COM, Hittite, Mini-Circuits, General Dynamics и др.);

Помимо этого, одним из направлений компании «ЭлектроПласт» является направление «Источники питания». Мы предлагаем Вам помощь Конструкторского отдела:

- Подбор оптимального решения, техническое обоснование при выборе компонента;
- Подбор аналогов;
- Консультации по применению компонента;
- Поставка образцов и прототипов;
- Техническая поддержка проекта;
- Защита от снятия компонента с производства.



#### Как с нами связаться

**Телефон:** 8 (812) 309 58 32 (многоканальный)

**Факс:** 8 (812) 320-02-42

**Электронная почта:** [org@eplast1.ru](mailto:org@eplast1.ru)

**Адрес:** 198099, г. Санкт-Петербург, ул. Калинина, дом 2, корпус 4, литера А.