



FEATURES

- Five-sided shielded metal package reduces radiated emissions
- Industry standard 1" x 1" x 0.40" encapsulated package and pinout
- Wide range input voltages 9-36 and 18-75 Vdc
- Bipolar $\pm 5V$, $\pm 12V$ and $\pm 15V$ outputs
- Up to 15 Watts or greater total output power with overtemperature shutdown
- Isolation up to 1600 VDC (basic)
- High efficiency flyback topology
- Usable -40 to 85°C temperature range (with derating)
- Assembly and attachment for RoHS standards
- Extensive self-protection shut down features
- Meets UL 60950-1, CAN/CSA-C22.2 No. 60950-1, IEC60950-1, EN60950-1 safety approvals (2nd Edition)

PRODUCT OVERVIEW

Featuring a full 15 Watt output in one square inch of board area, the BPM15 series isolated DC-DC converter family offers efficient regulated DC power for printed circuit board mounting. The wide range 4:1 inputs on the 1" x 1" x 0.40" (25.4 x 25.4 x 10.16mm) converter are either 9 to 36 Volts DC (Q12 models) or 18 to 75 Volts DC (Q48 models), ideal for battery-powered and telecom equipment. The industry-standard pinout fits larger 1" x 2" converters. Fixed output voltages of ± 5 , ± 12 or ± 15 VDC are regulated to within $\pm 0.25\%$. Applications include small instruments, area-limited microcontrollers, data communications equipment, remote sensor systems, vehicle and portable electronics.

The rugged mechanical, thermal, and electrical design of this product is intended for high reliability and harsh environments.

The BPM15 series includes full magnetic and optical isolation with Basic protection up to 1600 Volts DC. For powering digital systems, the outputs offer fast settling to step transients and will accept higher capacitive loads. Excellent ripple and noise specifications assure compatibility to noise-susceptible circuits. For systems requiring controlled startup/shutdown, an external remote On/Off control may use a switch, transistor or digital logic.

A wealth of self-protection features avoid both converter and external circuit faults. These include input undervoltage lockout and overtemperature shutdown. The outputs current limit using the "hiccup" autorestart technique and the outputs are short-circuit protected. Additional features include output overvoltage and reverse conduction elimination. The high efficiency offers minimal heat buildup and "no fan" operation.

CONNECTION DIAGRAM

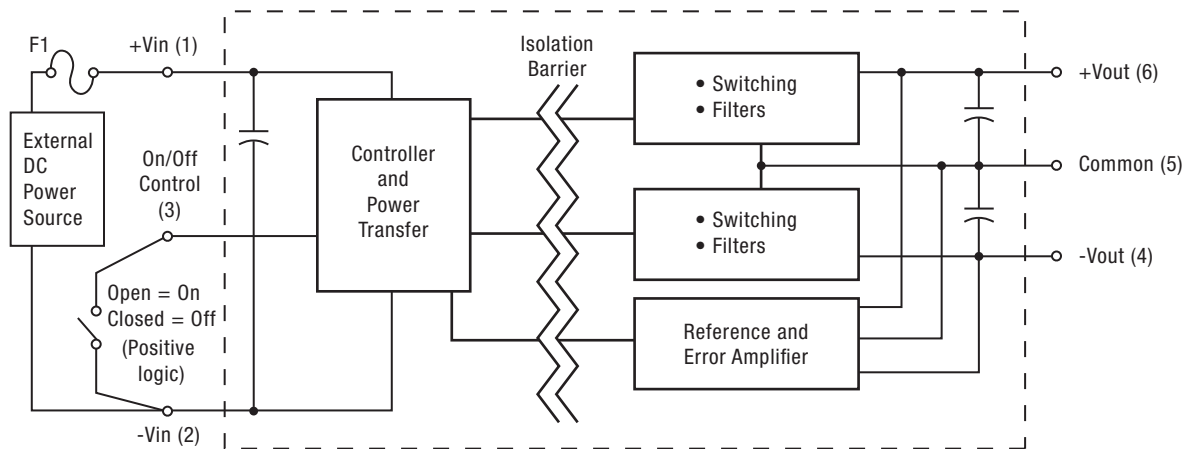

Typical topology is shown.

Murata Power Solutions recommends a fuse at F1.



| PERFORMANCE SPECIFICATIONS SUMMARY AND ORDERING GUIDE ① | | | | | | | | | | | | | | | |
|---|----------------------|-------------------------------|-----------------|-------------|------|-------------------|---------|--------------------------|-----------|-------------------------------------|----------------------------------|-------|----------------------|--------------|---------------------|
| Root Models ① | Output | | | | | | Input | | | | Efficiency | | Encapsulated Package | | |
| | V _{OUT} (V) | I _{OUT} (mA, max.) ② | Total Power (W) | R/N (mVp-p) | | Regulation (Max.) | | V _{IN} Nom. (V) | Range (V) | I _{IN} = minimum load (mA) | I _{IN} = full load (mA) | Min. | Typ. | (inches) | (mm) |
| | | | | Typ. | Max. | Line | Load ⑤ | | | | | | | | |
| BPM15-050-Q12 | ±5 | ±1500 | 15 | 60 | 100 | ±0.25% | ±0.25% | 24 | 9-36 | 90 | 740 | 82.5% | 84% | 1 x 1 x 0.40 | 25.4 x 25.4 x 10.16 |
| BPM15-050-Q48 | ±5 | ±1500 | 15 | 60 | 100 | ±0.25% | ±0.25% | 48 | 18-75 | 50 | 384 | 80% | 81.4% | | |
| BPM15-120-Q12 | ±12 | ±625 | 15 | 80 | 120 | ±0.25% | ±0.25% | 24 | 9-36 | 95 | 740 | 82% | 84% | | |
| BPM15-120-Q48 | ±12 | ±625 | 15 | 80 | 120 | ±0.25% | ±0.25% | 48 | 18-75 | 50 | 368 | 83% | 85% | | |
| BPM15-150-Q12 | ±15 | ±500 | 15 | 60 | 100 | ±0.25% | ±0.25% | 24 | 9-36 | 100 | 740 | 82.5% | 84.5% | | |
| BPM15-150-Q48 | ±15 | ±500 | 15 | 80 | 120 | ±0.25% | ±0.275% | 48 | 18-75 | 50 | 360 | 83% | 86% | | |

- ① Please refer to the part number structure for additional options and complete ordering part numbers.
- ② The minimum output load for the BPM15 series is 10% of maximum current to meet published specifications. The converter will not be damaged by less than 10% load but some specs may degrade slightly.
- ③ All specifications are at nominal line voltage and full load, +25 °C. unless otherwise noted. See detailed specifications and notes for full conditions.

Output capacitors are 1 µF ceramic in parallel with 10 µF. The input cap is 100 µF, low ESR electrolytic.

I/O caps are necessary for our test equipment and may not be needed for your application.

- ④ RoHS-6 compliance does not claim EU RoHS exemption 7b (lead in solder).
- ⑤ Balanced loads, 10% to 100% loads.

PART NUMBER STRUCTURE

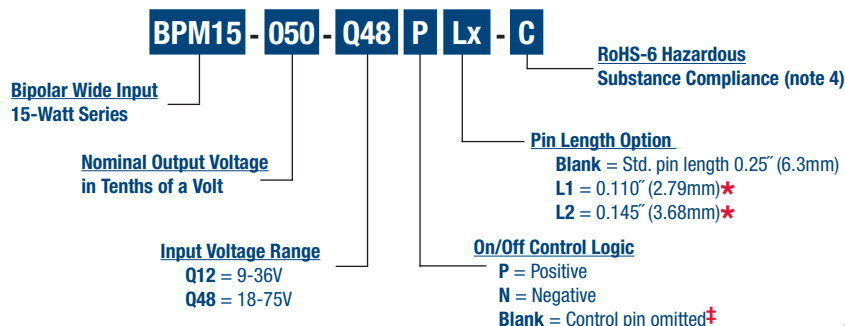

***Minimum order quantity is required. Samples available with standard pin length only.**

‡Some model number combinations may not be available. See website or contact your local Murata sales representative.

FUNCTIONAL SPECIFICATIONS, BPM15-050-Q12

| ABSOLUTE MAXIMUM RATINGS | Conditions ① | Minimum | Typical/Nominal | Maximum | Units |
|---------------------------|---|---------|-----------------|---------|-------|
| Input Voltage, Continuous | | 0 | | 36 | Vdc |
| Input Voltage, Transient | 100 mS max. duration | | | 50 | Vdc |
| Isolation Voltage | Input to output | | | 1600 | Vdc |
| On/Off Remote Control | Power on, referred to -Vin | 0 | | 15 | Vdc |
| Output Power | | 1.48 | | 15.15 | W |
| Output Current | Current-limited, no damage, short-circuit protected | 0.15 | | 1.5 | A |
| Storage Temperature Range | Vin = Zero (no power) | -55 | | 125 | °C |

Absolute maximums are stress ratings. Exposure of devices to greater than any of these conditions may adversely affect long-term reliability. Proper operation under conditions other than those listed in the Performance/Functional Specifications Table is not implied or recommended.

| INPUT | | | | | |
|---------------------------------------|---|-----|------|------|---------|
| Operating Voltage Range | | 9 | 24 | 36 | Vdc |
| Recommended External Fuse | Fast blow | | | 4 | A |
| Start-up Threshold | Rising input voltage | 8 | 8.5 | 9 | Vdc |
| Undervoltage Shutdown (50% load) | Falling input voltage | 7.7 | 8.2 | 8.7 | Vdc |
| Internal Filter Type | | | C | | |
| Input Current | | | | | |
| Full Load Input Current | Vin = nominal | | 0.74 | 0.77 | A |
| Low Line Input Current | Vin = minimum | | 2.03 | 2.09 | A |
| Inrush Transient | | | 0.05 | | A2-Sec. |
| Short Circuit Input Current | | | 0.05 | 0.1 | A |
| Minimum Load Input Current | Iout = minimum, unit = ON | | 90 | 150 | mA |
| Shut-Down Input Current (Off, UV, OT) | | | 1 | 2 | mA |
| Reflected (Back) Ripple Current ② | Measured at input with specified filter | | 25 | | mA, p-p |

| GENERAL and SAFETY | | | | | |
|-----------------------|--|------|----------|------|-------------------------|
| Efficiency | Vin = 24V, full load | 82.5 | 84 | | % |
| | Vin = min., full load | 80.5 | 82 | | % |
| Isolation | | | | | |
| Isolation Voltage | Input to output | | | 1600 | Vdc |
| Isolation Resistance | | | 10 | | MΩ |
| Isolation Capacitance | | | 1000 | | pF |
| Safety | Certified to UL-60950-1, CSA-C22.2 No. 60950-1, IEC/60950-1, 2nd edition, with AM1 | | Approved | | |
| Calculated MTBF | Per Telcordia SR332, issue 1, class 3, ground fixed, Tambient = +25°C | | 5.8 | | Hours x 10 ⁶ |

| DYNAMIC CHARACTERISTICS | | | | | |
|-----------------------------|---|-----|------|------|------|
| Fixed Switching Frequency | | 330 | 360 | 390 | KHz |
| Startup Time | Power on to Vout regulated | | | 50 | mS |
| Startup Time | Remote ON to Vout regulated | | | 50 | mS |
| Dynamic Load Response | 50-75-50% load step, settling time to within 1% of Vout | | 250 | 300 | μSec |
| Dynamic Load Peak Deviation | same as above | | ±100 | ±150 | mV |

| FEATURES and OPTIONS | | | | | |
|---------------------------|----------------------|------|---|-----|----|
| Remote On/Off Control ③ | | | | | |
| "N" suffix | | | | | |
| Negative Logic, ON state | ON = Ground pin | -0.7 | | 0.8 | V |
| Negative Logic, OFF state | OFF = Pin open | 10 | | 15 | V |
| Control Current | Open collector/drain | | 1 | | mA |
| "P" suffix | | | | | |
| Positive Logic, ON state | ON = Pin open | 10 | | 15 | V |
| Positive Logic, OFF state | OFF = Ground pin | -0.7 | | 0.8 | V |
| Control Current | Open collector/drain | | 1 | | mA |

FUNCTIONAL SPECIFICATIONS, BPM15-050-Q12 (CONT.)

| OUTPUT | Conditions ① ③ | Minimum | Typical/Nominal | Maximum | Units |
|---|--|---------|---------------------|---------|-----------|
| Total Output Power | | 1.48 | 15 | 15.15 | W |
| Voltage | | | | | |
| Nominal Output Voltage | No trim | ±4.95 | ±5 | ±5.05 | Vdc |
| Setting Accuracy | At 50% load, no trim | | ±1 | | % of Vnom |
| Overvoltage Protection | Via magnetic feedback | 5.6 | 6.5 | 7 | Vdc |
| Current | | | | | |
| Output Current Range | | ±0.15 | ±1.5 | ±1.5 | A |
| Current Limit Inception | 98% of Vnom., after warmup | ±1.65 | ±2.8 | ±3.3 | A |
| Short Circuit | | | | | |
| Short Circuit Current | Hiccup technique, autorecovery within ±1.25% of Vout | | | 0.3 | A |
| Short Circuit Duration (remove short for recovery) | Output shorted to ground, no damage | | Continuous | | |
| Short circuit protection method | Current limiting | | | | |
| Regulation | | | | | |
| Line Regulation | Vin = min. to max., Vout = nom., Iout = nom. | | | ±0.25 | % of Vout |
| Load Regulation | Iout = min. to max., Vin = 24V | | | ±0.25 | % of Vout |
| Ripple and Noise | 5 Hz - 20 MHz BW, Vin = 24V | | 60 | 100 | mV pk-pk |
| Maximum Capacitive Loading | Low ESR, 0.02 Ω max | | | 520 | μF |
| MECHANICAL | | | | | |
| Outline Dimensions | | | 1 x 1 x 0.40 | | Inches |
| (Please refer to outline drawing) | WxLxH | | 25.4 x 25.4 x 10.16 | | mm |
| Weight | | | 0.69 | | Ounces |
| | | | 19.56 | | Grams |
| Through Hole Pin Diameter | | | 0.04 | | Inches |
| | | | 1.016 | | mm |
| Through Hole Pin Material | | | Copper alloy | | |
| TH Pin Plating Metal and Thickness | Nickel subplate | | 50 | | μ-inches |
| | Gold overplate | | 5 | | μ-inches |
| ENVIRONMENTAL | | | | | |
| Operating Ambient Temperature Range | See derating | -40 | | 85 | °C |
| Operating Case Temperature Range | No derating | -40 | | 93 | °C |
| Case Material | Tin plated steel with black powder coat | | | | |
| Storage Temperature | Vin = Zero (no power) | -55 | | 125 | °C |
| Thermal Protection/Shutdown | Measured in center | 120 | 130 | 140 | °C |
| Electromagnetic Interference | External filter is required | | | | |
| Conducted, EN55022/CISPR22 | | | B | | Class |
| RoHS rating | | | RoHS-6 | | |

Notes

① Unless otherwise noted, all specifications are at nominal input voltage, nominal output voltage and full load. General conditions are +25° Celsius ambient temperature, near sea level altitude, natural convection airflow. All models are tested and specified with external parallel 1 μF and 10 μF output capacitors. The external input capacitor is 100 μF, electrolytic.

② Input (back) ripple current is tested and specified over 5 Hz to 20 MHz bandwidth. Input filtering is Cbus = 220 μF, Cin = 33 μF and Lbus = 12 μH.

③ The Remote On/Off Control is referred to -Vin.

PERFORMANCE DATA, BPM15-050-Q12

Efficiency vs. Line Voltage and Load Current @ +25°C

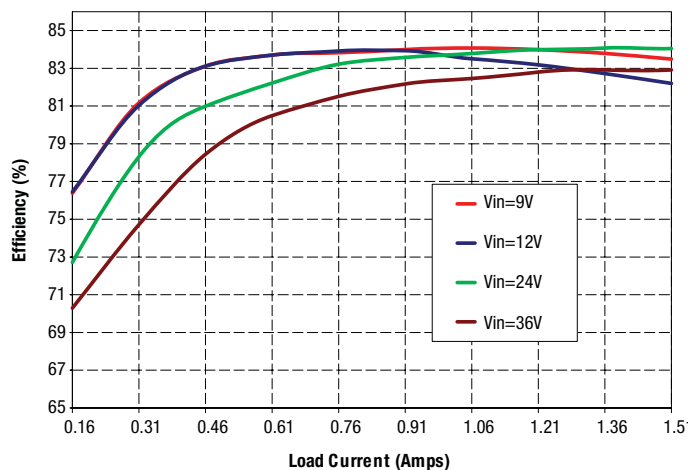

Power Dissipation vs. Line Voltage and Load Current @ +25°C

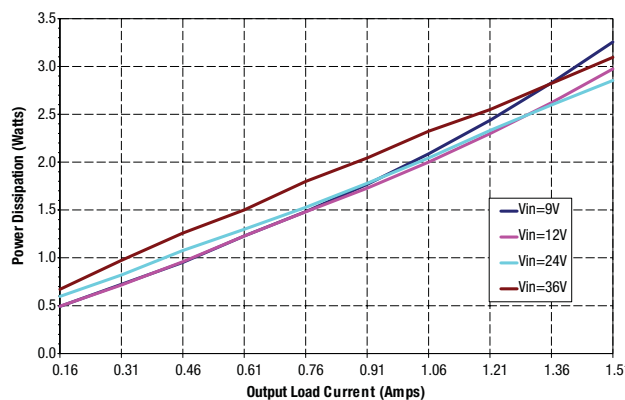

Maximum Current Temperature Derating at Sea Level (VIN = 9V, airflow is from pin 1 to pin 4)

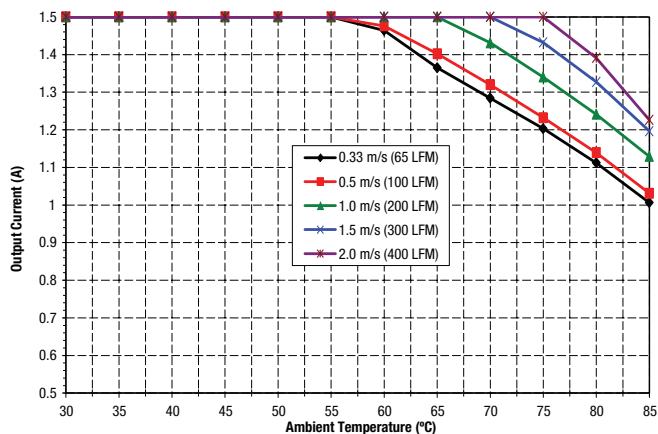

Maximum Current Temperature Derating at Sea Level (VIN = 12V, airflow is from pin 1 to pin 4)

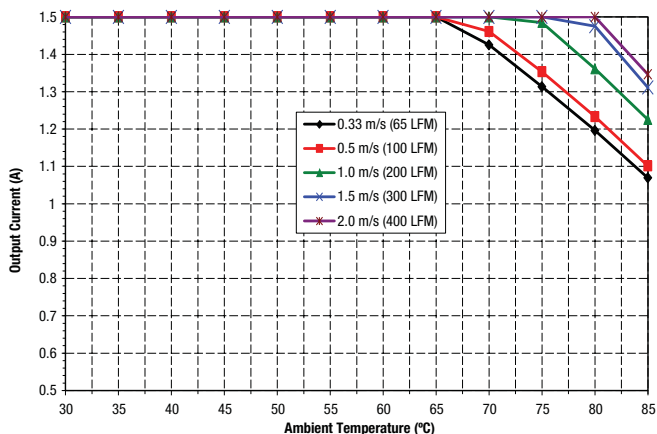

PERFORMANCE DATA, BPM15-050-Q12

Maximum Current Temperature Derating at Sea Level
($V_{IN} = 18V$, airflow is from pin 1 to pin 24)



Maximum Current Temperature Derating at Sea Level
($V_{IN} = 24V$, airflow is from pin 1 to pin 4)



Maximum Current Temperature Derating at Sea Level
($V_{IN} = 30V$, airflow is from pin 1 to pin 4)



Maximum Current Temperature Derating at Sea Level
($V_{IN} = 36V$, airflow is from pin 1 to pin 4)



FUNCTIONAL SPECIFICATIONS, BPM15-120-Q12

| ABSOLUTE MAXIMUM RATINGS | Conditions ① | Minimum | Typical/Nominal | Maximum | Units |
|---|---|---------|-----------------|---------|-------------------------|
| Input Voltage, Continuous | | 0 | | 36 | Vdc |
| Input Voltage, Transient | 100 mS max. duration | | | 50 | Vdc |
| Isolation Voltage | Input to output | | | 1600 | Vdc |
| On/Off Remote Control | Power on, referred to -Vin | 0 | | 15 | Vdc |
| Output Power | | 1.48 | | 15.15 | W |
| Output Current | Current-limited, no damage, short-circuit protected | 0.0625 | | 0.625 | A |
| Storage Temperature Range | Vin = Zero (no power) | -55 | | 125 | °C |
| Absolute maximums are stress ratings. Exposure of devices to greater than any of these conditions may adversely affect long-term reliability. Proper operation under conditions other than those listed in the Performance/Functional Specifications Table is not implied or recommended. | | | | | |
| INPUT | | | | | |
| Operating Voltage Range | | 9 | 24 | 36 | Vdc |
| Recommended External Fuse | Fast blow | | | 4 | A |
| Start-up Threshold | Rising input voltage | 8 | 8.5 | 9 | Vdc |
| Undervoltage Shutdown (50% load) | Falling input voltage | 7.7 | 8.2 | 8.7 | Vdc |
| Internal Filter Type | | | C | | |
| Input Current | | | | | |
| Full Load Input Current | Vin = nominal | | 0.74 | 0.77 | A |
| Low Line Input Current | Vin = minimum | | 1.98 | 2.05 | A |
| Inrush Transient | | | 0.05 | | A2-Sec. |
| Short Circuit Input Current | | | 0.05 | 0.1 | A |
| No Load Input Current | Iout = minimum, unit=ON | | 95 | 125 | mA |
| Shut-Down Input Current (Off, UV, OT) | | | 1 | 2 | mA |
| Reflected (Back) Ripple Current ② | Measured at input with specified filter | | 30 | | mA, p-p |
| GENERAL and SAFETY | | | | | |
| Efficiency | Vin = 24V, full load | 82 | 84.3 | | % |
| | Vin = min., full load | 82 | 84 | | % |
| Isolation | | | | | |
| Isolation Voltage | Input to output | | | 1600 | Vdc |
| Isolation Resistance | | 10 | | | MΩ |
| Isolation Capacitance | | | 600 | | pF |
| Safety | Certified to UL-60950-1, CSA-C22.2 No. 60950-1, IEC/60950-1, 2nd edition, with AM1 Per Telcordia SR332, issue 1, class 3, ground fixed, Tambient = +25°C | | Approved | | |
| Calculated MTBF | | | 7 | | Hours x 10 ⁶ |
| DYNAMIC CHARACTERISTICS | | | | | |
| Fixed Switching Frequency | | 295 | 325 | 355 | KHz |
| Startup Time | Power on to Vout regulated | | | 50 | mS |
| Startup Time | Remote ON to Vout regulated | | | 60 | mS |
| Dynamic Load Response | 50-75-50% load step, settling time to within 1% of Vout | | 250 | 300 | μSec |
| Dynamic Load Peak Deviation | same as above | | ±150 | ±250 | mV |
| FEATURES and OPTIONS | | | | | |
| Remote On/Off Control ③ | | | | | |
| "N" suffix | | | | | |
| Negative Logic, ON state | ON = Ground pin | -0.7 | | 0.8 | V |
| Negative Logic, OFF state | OFF = Pin open | 10 | | 15 | V |
| Control Current | Open collector/drain | | 1 | | mA |
| "P" suffix | | | | | |
| Positive Logic, ON state | ON = Pin open | 10 | | 15 | V |
| Positive Logic, OFF state | OFF = Ground pin | -0.7 | | 0.8 | V |
| Control Current | Open collector/drain | | 1 | | mA |

FUNCTIONAL SPECIFICATIONS, BPM15-120-Q12 (CONT.)

| OUTPUT | Conditions ① ③ | Minimum | Typical/Nominal | Maximum | Units |
|---|--|---------|---------------------|---------|-----------|
| Total Output Power | | 1.48 | 15 | 15.15 | W |
| Voltage | | | | | |
| Nominal Output Voltage | No trim | ±11.88 | ±12 | ±12.12 | Vdc |
| Setting Accuracy | At 50% load, no trim | | ±1 | | % of Vnom |
| Overvoltage Protection | Via magnetic feedback | 15 | 16 | 16.5 | Vdc |
| Current | | | | | |
| Output Current Range | | ±0.0625 | ±0.625 | ±0.625 | A |
| Current Limit Inception | 98% of Vnom., after warmup | ±0.75 | ±1.025 | ±1.30 | A |
| Short Circuit | | | | | |
| Short Circuit Current | Hiccup technique, autorecovery within ±1.25% of Vout | | | 0.3 | A |
| Short Circuit Duration (remove short for recovery) | Output shorted to ground, no damage | | Continuous | | |
| Short circuit protection method | Current limiting | | | | |
| Regulation | | | | | |
| Line Regulation | Vin = min. to max., Vout = nom., Iout = nom. | | | ±0.25 | % of Vout |
| Load Regulation | Iout = min. to max., Vin = 24V | | | ±0.25 | % of Vout |
| Ripple and Noise | 5 Hz- 20 MHz BW, Vin = 24V | | 80 | 120 | mV pk-pk |
| Maximum Capacitive Loading | Low ESR, 0.02 ohms max | | | 520 | µF |
| MECHANICAL | | | | | |
| Outline Dimensions | | | 1 x 1 x 0.40 | | Inches |
| (Please refer to outline drawing) | WxLxH | | 25.4 x 25.4 x 10.16 | | mm |
| Weight | | | 0.69 | | Ounces |
| | | | 19.56 | | Grams |
| Through Hole Pin Diameter | | | 0.04 | | Inches |
| | | | 1.016 | | mm |
| Through Hole Pin Material | | | Copper alloy | | |
| TH Pin Plating Metal and Thickness | Nickel subplate | | 50 | | µ-inches |
| | Gold overplate | | 5 | | µ-inches |
| ENVIRONMENTAL | | | | | |
| Operating Ambient Temperature Range | See derating | -40 | | 85 | °C |
| Operating Case Temperature Range | No derating | -40 | | 108 | °C |
| Case Material | Tin plated steel with black powder coat | | | | |
| Storage Temperature | Vin = Zero (no power) | -55 | | 125 | °C |
| Thermal Protection/Shutdown | Measured in center | 120 | 130 | 140 | °C |
| Electromagnetic Interference | External filter is required | | | | |
| Conducted, EN55022/CISPR22 | | | B | | Class |
| RoHS rating | | | RoHS-6 | | |

Notes

① Unless otherwise noted, all specifications are at nominal input voltage, nominal output voltage and full load. General conditions are +25° Celsius ambient temperature, near sea level altitude, natural convection airflow. All models are tested and specified with external parallel 1 µF and 10 µF output capacitors. The external input capacitor is 100 µF.

② Input (back) ripple current is tested and specified over 5 Hz to 20 MHz bandwidth. Input filtering is Cbus = 220 µF, Cin = 33 µF and Lbus = 12 µH.

③ The Remote On/Off Control is referred to -Vin.

PERFORMANCE DATA, BPM15-120-Q12

Efficiency vs. Line Voltage and Load Current @ +25°C

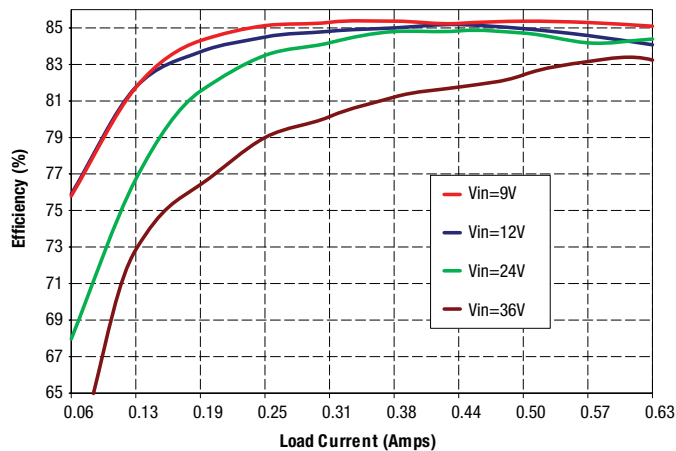

Power Dissipation vs. Line Voltage and Load Current @ +25°C

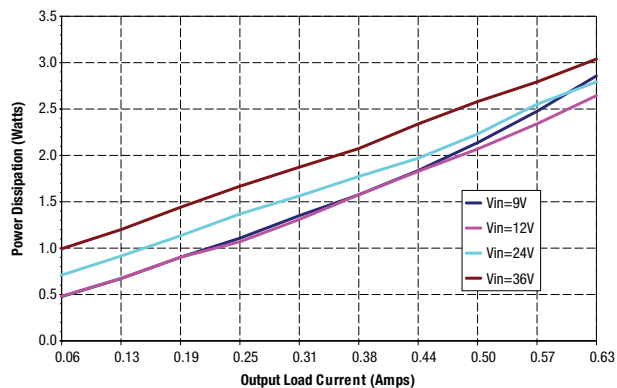

**Maximum Current Temperature Derating at Sea Level
(VIN = 9V, airflow is from pin 1 to pin 4)**



**Maximum Current Temperature Derating at Sea Level
(VIN = 12V, airflow is from pin 1 to pin 4)**

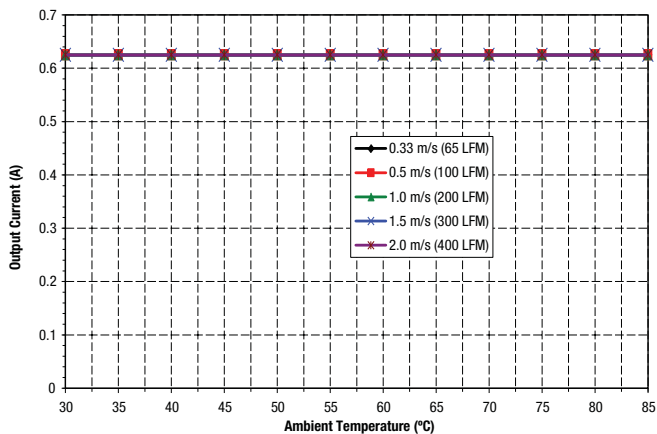

PERFORMANCE DATA, BPM15-120-Q12

Maximum Current Temperature Derating at Sea Level
($V_{IN} = 18V$, airflow is from pin 1 to pin 4)



Maximum Current Temperature Derating at Sea Level
($V_{IN} = 24V$, airflow is from pin 1 to pin 4)



Maximum Current Temperature Derating at Sea Level
($V_{IN} = 30V$, airflow is from pin 1 to pin 4)



Maximum Current Temperature Derating at Sea Level
($V_{IN} = 36V$, airflow is from pin 1 to pin 4)



FUNCTIONAL SPECIFICATIONS, BPM15-150-Q12

| ABSOLUTE MAXIMUM RATINGS | Conditions ① | Minimum | Typical/Nominal | Maximum | Units |
|---|---|---------|-----------------|---------|-------------------------|
| Input Voltage, Continuous | | 0 | | 36 | Vdc |
| Input Voltage, Transient | 100 mS max. duration | | | 50 | Vdc |
| Isolation Voltage | Input to output | | | 1600 | Vdc |
| On/Off Remote Control | Power on, referred to -Vin | 0 | | 15 | Vdc |
| Output Power | | 1.485 | | 15.15 | W |
| Output Current | Current-limited, no damage, short-circuit protected | 0.05 | | 0.5 | A |
| Storage Temperature Range | Vin = Zero (no power) | -55 | | 125 | °C |
| Absolute maximums are stress ratings. Exposure of devices to greater than any of these conditions may adversely affect long-term reliability. Proper operation under conditions other than those listed in the Performance/Functional Specifications Table is not implied or recommended. | | | | | |
| INPUT | | | | | |
| Operating Voltage Range | | 9 | 24 | 36 | Vdc |
| Recommended External Fuse | Fast blow | | | 4 | A |
| Start-up Threshold | Rising input voltage | 8 | 8.5 | 9 | Vdc |
| Undervoltage Shutdown (50% load) | Falling input voltage | 7.7 | 8.2 | 8.7 | Vdc |
| Internal Filter Type | | | C | | |
| Input Current | | | | | |
| Full Load Input Current | Vin = nominal | | 74 | 0.77 | A |
| Low Line Input Current | Vin = minimum | | 1.96 | 2.03 | A |
| Inrush Transient | | | 0.05 | | A2-Sec. |
| Short Circuit Input Current | | | 0.05 | 0.1 | A |
| No Load Input Current | Iout = minimum, unit=ON | | 100 | 130 | mA |
| Shut-Down Input Current (Off, UV, OT) | | | 1 | 2 | mA |
| Reflected (Back) Ripple Current ② | Measured at input with specified filter | | 10 | | mA, p-p |
| GENERAL and SAFETY | | | | | |
| Efficiency | Vin = 24V, full load | 82.5 | 84.5 | | % |
| | Vin = min., full load | 83.0 | 85.0 | | % |
| Isolation | | | | | |
| Isolation Voltage | Input to output | | | 1600 | Vdc |
| Isolation Resistance | | 10 | | | MΩ |
| Isolation Capacitance | | | 1000 | | pF |
| Safety | Certified to UL-60950-1, CSA-C22.2 No. 60950-1, IEC/60950-1, 2nd edition, with AM1 Per Telcordia SR332, issue 1, class 3, ground fixed, Tambient = +25°C | | Approved | | |
| Calculated MTBF | | | 6.7 | | Hours x 10 ⁶ |
| DYNAMIC CHARACTERISTICS | | | | | |
| Fixed Switching Frequency | | 300 | 330 | 360 | KHz |
| Startup Time | Power on to Vout regulated | | | 50 | mS |
| Startup Time | Remote ON to Vout regulated | | | 50 | mS |
| Dynamic Load Response | 50-75-50% load step, settling time to within 1% of Vout | | 250 | 300 | μSec |
| Dynamic Load Peak Deviation | same as above | | ±100 | ±200 | mV |
| FEATURES and OPTIONS | | | | | |
| Remote On/Off Control ③ | | | | | |
| "N" suffix | | | | | |
| Negative Logic, ON state | ON = Ground pin | -0.7 | | 0.8 | V |
| Negative Logic, OFF state | OFF = Pin open | 10 | | 15 | V |
| Control Current | Open collector/drain | | 1 | | mA |
| "P" suffix | | | | | |
| Positive Logic, ON state | ON = Pin open | 10 | | 15 | V |
| Positive Logic, OFF state | OFF = Ground pin | -0.7 | | 0.8 | V |
| Control Current | Open collector/drain | | 1 | | mA |

FUNCTIONAL SPECIFICATIONS, BPM15-150-Q12 (CONT.)

| OUTPUT | Conditions ① ③ | Minimum | Typical/Nominal | Maximum | Units |
|---|--|---------|---------------------|---------|-----------|
| Total Output Power | | 1.485 | 15.00 | 15.15 | W |
| Voltage | | | | | |
| Nominal Output Voltage | No trim | 14.850 | 15.00 | 15.150 | Vdc |
| Setting Accuracy | At 50% load, no trim | | 1 | | % of Vnom |
| Overvoltage Protection | Via magnetic feedback | 16.8 | 18 | 20.5 | Vdc |
| Current | | | | | |
| Output Current Range | | ±0.05 | ±0.5 | ±0.5 | A |
| Current Limit Inception | 98% of Vnom., after warmup | ±0.7 | ±0.95 | ±1.2 | A |
| Short Circuit | | | | | |
| Short Circuit Current | Hiccup technique, autorecovery within ±1.25% of Vout | | | 0.3 | A |
| Short Circuit Duration (remove short for recovery) | Output shorted to ground, no damage | | Continuous | | |
| Short circuit protection method | Current limiting | | | | |
| Regulation | | | | | |
| Line Regulation | Vin = min. to max., Vout = nom., Iout = nom. | | ±0.05 | ±0.25 | % of Vout |
| Load Regulation | Iout = min. to max., Vin = 24V | | ±0.05 | ±0.25 | % of Vout |
| Ripple and Noise | 5 Hz- 20 MHz BW, Vin=24V | | 60 | 100 | mV pk-pk |
| Maximum Capacitive Loading | Low ESR, 0.02 ohms max | | | 520 | µF |
| MECHANICAL | | | | | |
| Outline Dimensions | | | 1 x 1 x 0.40 | | Inches |
| (Please refer to outline drawing) | W x L x H | | 25.4 x 25.4 x 10.16 | | mm |
| Weight | | | 0.69 | | Ounces |
| | | | 19.56 | | Grams |
| Through Hole Pin Diameter | | | 0.04 | | Inches |
| | | | 1.016 | | mm |
| Through Hole Pin Material | | | Copper alloy | | |
| TH Pin Plating Metal and Thickness | Nickel subplate | | 50 | | µ-inches |
| | Gold overplate | | 5 | | µ-inches |
| ENVIRONMENTAL | | | | | |
| Operating Ambient Temperature Range | See derating | -40 | | 85 | °C |
| Operating Case Temperature Range | No derating | -40 | | 91 | °C |
| Case Material | Tin plated steel with black powder coat | | | | |
| Storage Temperature | Vin = Zero (no power) | -55 | | 125 | °C |
| Thermal Protection/Shutdown | Measured in center | 120 | 130 | 140 | °C |
| Electromagnetic Interference | External filter is required | | | | |
| Conducted, EN55022/CISPR22 | | | B | | Class |
| RoHS rating | | | RoHS-6 | | |

Notes

① Unless otherwise noted, all specifications are at nominal input voltage, nominal output voltage and full load. General conditions are +25° Celsius ambient temperature, near sea level altitude, natural convection airflow. All models are tested and specified with external parallel 1 µF and 10 µF output capacitors. The external input capacitor is 100 µF.

② Input (back) ripple current is tested and specified over 5 Hz to 20 MHz bandwidth. Input filtering is Cbus = 220 µF, Cin = 33 µF and Lbus = 12 µH.

③ The Remote On/Off Control is referred to -Vin.

PERFORMANCE DATA, BPM15-150-Q12

Efficiency vs. Line Voltage and Load Current @ +25°C

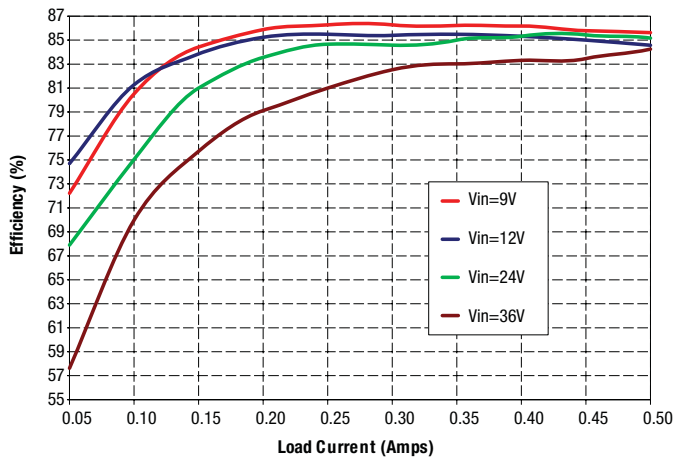

Power Dissipation vs. Line Voltage and Load Current @ +25°C



**Maximum Current Temperature Derating at Sea Level
(VIN = 9V, airflow is from pin 1 to pin 4)**



**Maximum Current Temperature Derating at Sea Level
(VIN = 12V, airflow is from pin 1 to pin 4)**



PERFORMANCE DATA, BPM15-150-Q12

Maximum Current Temperature Derating at Sea Level
($V_{IN} = 18V$, airflow is from pin 1 to pin 4)

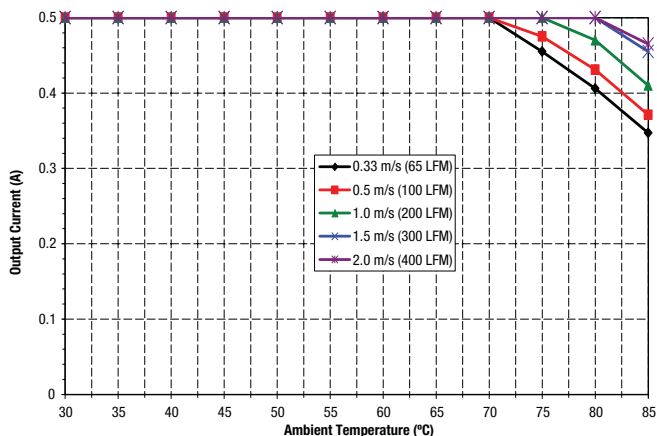

Maximum Current Temperature Derating at Sea Level
($V_{IN} = 24V$, airflow is from pin 1 to pin 4)

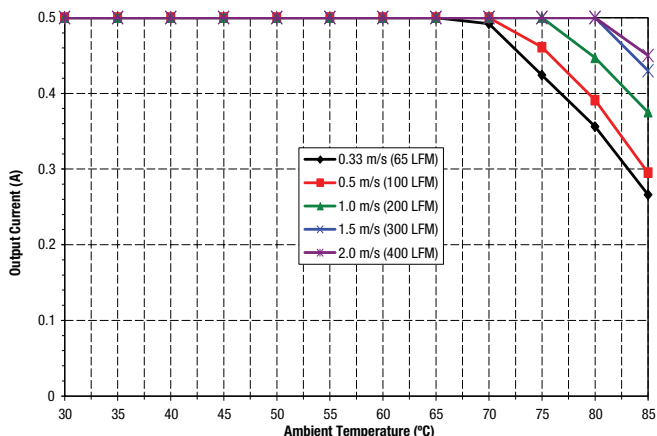

Maximum Current Temperature Derating at Sea Level
($V_{IN} = 30V$, airflow is from pin 1 to pin 4)

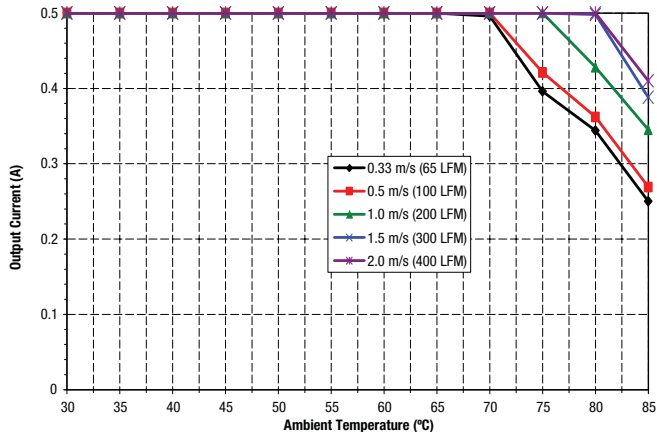

Maximum Current Temperature Derating at Sea Level
($V_{IN} = 36V$, airflow is from pin 1 to pin 4)

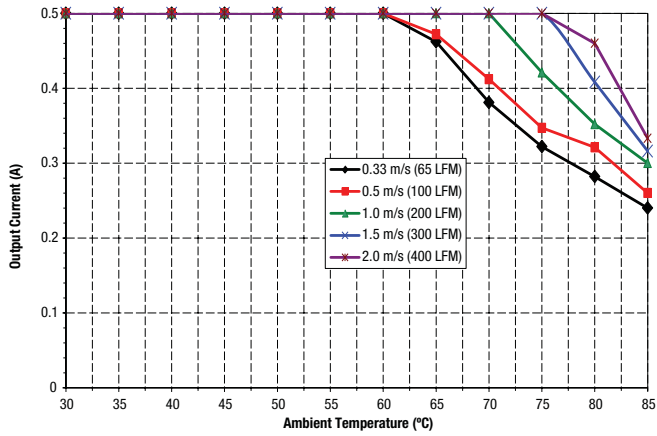

FUNCTIONAL SPECIFICATIONS, BPM15-050-Q48

| ABSOLUTE MAXIMUM RATINGS | Conditions ① | Minimum | Typical/Nominal | Maximum | Units |
|---------------------------|---|---------|-----------------|---------|-------|
| Input Voltage, Continuous | | 0 | | 75 | Vdc |
| Input Voltage, Transient | 100 mS max. duration | | | 100 | Vdc |
| Isolation Voltage | Input to output | | | 1600 | Vdc |
| On/Off Remote Control | Power on, referred to -Vin | 0 | | 15 | Vdc |
| Output Power | | 1.48 | | 15.23 | W |
| Output Current | Current-limited, no damage, short-circuit protected | 0.15 | | 1.5 | A |
| Storage Temperature Range | Vin = Zero (no power) | -55 | | 125 | °C |

Absolute maximums are stress ratings. Exposure of devices to greater than any of these conditions may adversely affect long-term reliability. Proper operation under conditions other than those listed in the Performance/Functional Specifications Table is not implied or recommended.

| INPUT | | | | | |
|---------------------------------------|---|------|-------|-------|---------|
| Operating Voltage Range | | 18 | 48 | 75 | Vdc |
| Recommended External Fuse | Fast blow | | | 2 | A |
| Start-up Threshold | Rising input voltage | 15.5 | 16.5 | 17.5 | Vdc |
| Undervoltage Shutdown (50% load) | Falling input voltage | 15 | 16 | 17 | Vdc |
| Internal Filter Type | | | C | | |
| Input Current | | | | | |
| Full Load Input Current | Vin = nominal | | 0.384 | 0.396 | A |
| Low Line Input Current | Vin = minimum | | 1.019 | 1.057 | A |
| Inrush Transient | | | 0.05 | | A2-Sec. |
| Short Circuit Input Current | | | 0.05 | 0.1 | A |
| Minimum Load Input Current | Iout = minimum, unit = ON | | 50 | 100 | mA |
| Shut-Down Input Current (Off, UV, OT) | | | 1 | 2 | mA |
| Reflected (Back) Ripple Current ② | Measured at input with specified filter | | 50 | | mA, p-p |

| GENERAL and SAFETY | | | | | |
|-----------------------|--|----|----------|------|-------------------------|
| Efficiency | Vin = 48V, full load | 80 | 81.4 | | % |
| | Vin = min., full load | 80 | 81.8 | | % |
| Isolation | | | | | |
| Isolation Voltage | Input to output | | | 1600 | Vdc |
| Isolation Resistance | | | 10 | | MΩ |
| Isolation Capacitance | | | 1500 | | pF |
| Safety | Certified to UL-60950-1, CSA-C22.2 No. 60950-1, IEC/60950-1, 2nd edition, with AM1 | | Approved | | |
| Calculated MTBF | Per Telcordia SR332, issue 1, class 3, ground fixed, Tambient = +25°C | | 5 | | Hours x 10 ⁶ |

| DYNAMIC CHARACTERISTICS | | | | | |
|-----------------------------|---|-----|------|------|------|
| Fixed Switching Frequency | | 275 | 305 | 335 | KHz |
| Startup Time | Power on to Vout regulated | | | 50 | mS |
| Startup Time | Remote ON to Vout regulated | | | 50 | mS |
| Dynamic Load Response | 50-75-50% load step, settling time to within 1% of Vout | | 100 | 200 | μSec |
| Dynamic Load Peak Deviation | same as above | | ±100 | ±150 | mV |

| FEATURES and OPTIONS | | | | | |
|---------------------------|----------------------|------|---|-----|----|
| Remote On/Off Control ③ | | | | | |
| "N" suffix | | | | | |
| Negative Logic, ON state | ON = Ground pin | -0.7 | | 0.8 | V |
| Negative Logic, OFF state | OFF = Pin open | 10 | | 15 | V |
| Control Current | Open collector/drain | | 1 | | mA |
| "P" suffix | | | | | |
| Positive Logic, ON state | ON = Pin open | 10 | | 15 | V |
| Positive Logic, OFF state | OFF = Ground pin | -0.7 | | 0.8 | V |
| Control Current | Open collector/drain | | 1 | | mA |

FUNCTIONAL SPECIFICATIONS, BPM15-050-Q48 (CONT.)

| OUTPUT | Conditions ① ③ | Minimum | Typical/Nominal | Maximum | Units |
|---|--|---------|---------------------|---------|-----------|
| Total Output Power | | 1.48 | 15 | 15.23 | W |
| Voltage | | | | | |
| Nominal Output Voltage | No trim | ±4.925 | ±5 | ±5.075 | Vdc |
| Setting Accuracy | At 50% load, no trim | | ±1.5 | | % of Vnom |
| Overvoltage Protection | Via magnetic feedback | 5.6 | 7 | 8 | Vdc |
| Current | | | | | |
| Output Current Range | | ±0.15 | ±1.5 | ±1.5 | A |
| Current Limit Inception | 98% of Vnom., after warmup | ±1.7 | ±2.7 | ±3.0 | A |
| Short Circuit | | | | | |
| Short Circuit Current | Hiccup technique, autorecovery within ±1.25% of Vout | | | 0.3 | A |
| Short Circuit Duration (remove short for recovery) | Output shorted to ground, no damage | | Continuous | | |
| Short circuit protection method | Current limiting | | | | |
| Regulation | | | | | |
| Line Regulation | Vin = min. to max., Vout = nom., Iout = nom. | | | ±0.25 | % of Vout |
| Load Regulation | Iout = min. to max., Vin = 48V | | | ±0.25 | % of Vout |
| Ripple and Noise | 5 Hz - 20 MHz BW, Vin = 48V | | 60 | 100 | mV pk-pk |
| Maximum Capacitive Loading | Low ESR, 0.02 Ω max | | | 1000 | μF |
| MECHANICAL | | | | | |
| Outline Dimensions | | | 1 x 1 x 0.40 | | Inches |
| (Please refer to outline drawing) | WxLxH | | 25.4 x 25.4 x 10.16 | | mm |
| Weight | | | 0.69 | | Ounces |
| | | | 19.56 | | Grams |
| Through Hole Pin Diameter | | | 0.04 | | Inches |
| | | | 1.016 | | mm |
| Through Hole Pin Material | | | Copper alloy | | |
| TH Pin Plating Metal and Thickness | Nickel subplate | | 50 | | μ-inches |
| | Gold overplate | | 5 | | μ-inches |
| ENVIRONMENTAL | | | | | |
| Operating Ambient Temperature Range | See derating | -40 | | 85 | °C |
| Operating Case Temperature Range | No derating | -40 | | 93 | °C |
| Case Material | Tin plated steel with black powder coat | | | | |
| Storage Temperature | Vin = Zero (no power) | -55 | | 125 | °C |
| Thermal Protection/Shutdown | Measured in center | 120 | 130 | 140 | °C |
| Electromagnetic Interference | External filter is required | | | | |
| Conducted, EN55022/CISPR22 | | | B | | Class |
| RoHS rating | | | RoHS-6 | | |

Notes

① Unless otherwise noted, all specifications are at nominal input voltage, nominal output voltage and full load. General conditions are +25° Celsius ambient temperature, near sea level altitude, natural convection airflow. All models are tested and specified with external parallel 1 μF and 10 μF output capacitors. The external input capacitor is 100 μF.

② Input (back) ripple current is tested and specified over 5 Hz to 20 MHz bandwidth. Input filtering is Cbus = 220 μF, Cin = 33 μF and Lbus = 12 μH.

③ The Remote On/Off Control is referred to -Vin.

PERFORMANCE DATA, BPM15-050-Q48

Efficiency vs. Line Voltage and Load Current @ +25°C



Power Dissipation vs. Line Voltage and Load Current @ +25°C

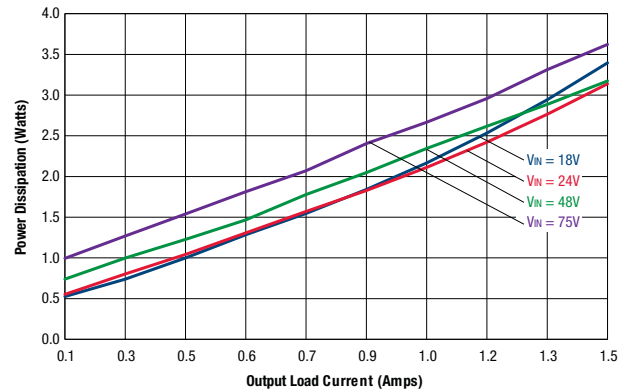

**Maximum Current Temperature Derating at Sea Level
(VIN = 18V, airflow is from pin 1 to pin 2)**



**Maximum Current Temperature Derating at Sea Level
(VIN = 24V, airflow is from pin 1 to pin 2)**

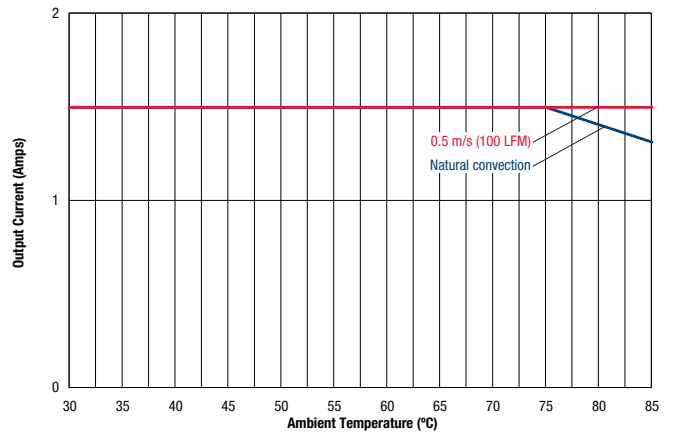

PERFORMANCE DATA, BPM15-050-Q48

Maximum Current Temperature Derating at Sea Level
($V_{IN} = 36V$, airflow is from pin 1 to pin 2)



Maximum Current Temperature Derating at Sea Level
($V_{IN} = 48V$, airflow is from pin 1 to pin 2)



Maximum Current Temperature Derating at Sea Level
($V_{IN} = 60V$, airflow is from pin 1 to pin 2)



Maximum Current Temperature Derating at Sea Level
($V_{IN} = 75V$, airflow is from pin 1 to pin 2)



FUNCTIONAL SPECIFICATIONS, BPM15-120-Q48

| ABSOLUTE MAXIMUM RATINGS | Conditions ① | Minimum | Typical/Nominal | Maximum | Units |
|---|---|---------|-----------------|---------|-------------------------|
| Input Voltage, Continuous | | 0 | | 75 | Vdc |
| Input Voltage, Transient | 100 mS max. duration | | | 100 | Vdc |
| Isolation Voltage | Input to output | | | 1600 | Vdc |
| On/Off Remote Control | Power on, referred to -Vin | 0 | | 15 | Vdc |
| Output Power | | 1.48 | | 15.15 | W |
| Output Current | Current-limited, no damage, short-circuit protected | 0.0625 | | 0.625 | A |
| Storage Temperature Range | Vin = Zero (no power) | -55 | | 125 | °C |
| Absolute maximums are stress ratings. Exposure of devices to greater than any of these conditions may adversely affect long-term reliability. Proper operation under conditions other than those listed in the Performance/Functional Specifications Table is not implied or recommended. | | | | | |
| INPUT | | | | | |
| Operating Voltage Range | | 18 | 48 | 75 | Vdc |
| Recommended External Fuse | Fast blow | | | 2 | A |
| Start-up Threshold | Rising input voltage | 15.5 | 17 | 17.9 | Vdc |
| Undervoltage Shutdown (50% load) | Falling input voltage | 15 | 16.2 | 17.5 | Vdc |
| Internal Filter Type | | | C | | |
| Input Current | | | | | |
| Full Load Input Current | Vin = nominal | | 0.368 | 0.38 | A |
| Low Line Input Current | Vin = minimum | | 0.99 | 1.01 | A |
| Inrush Transient | | | 0.05 | | A2-Sec. |
| Short Circuit Input Current | | | 0.05 | 0.1 | A |
| No Load Input Current | Iout = minimum, unit=ON | | 50 | 100 | mA |
| Shut-Down Input Current (Off, UV, OT) | | | 1 | 2 | mA |
| Reflected (Back) Ripple Current ② | Measured at input with specified filter | | 40 | | mA, p-p |
| GENERAL and SAFETY | | | | | |
| Efficiency | Vin = 48V, full load | 83 | 85 | | % |
| | Vin = min., full load | 83 | 84.5 | | % |
| Isolation | | | | | |
| Isolation Voltage | Input to output | | | 1600 | Vdc |
| Isolation Resistance | | 10 | | | MΩ |
| Isolation Capacitance | | | 1500 | | pF |
| Safety | Certified to UL-60950-1, CSA-C22.2 No. 60950-1, IEC/60950-1, 2nd edition, with AM1 Per Telcordia SR332, issue 1, class 3, ground fixed, Tambient = +25°C | | Approved | | |
| Calculated MTBF | | | 5 | | Hours x 10 ⁶ |
| DYNAMIC CHARACTERISTICS | | | | | |
| Fixed Switching Frequency | | 290 | 320 | 350 | KHz |
| Startup Time | Power on to Vout regulated | | | 50 | mS |
| Startup Time | Remote ON to Vout regulated | | | 60 | mS |
| Dynamic Load Response | 50-75-50% load step, settling time to within 1% of Vout | | 150 | 250 | μSec |
| Dynamic Load Peak Deviation | same as above | | ±100 | ±200 | mV |
| FEATURES and OPTIONS | | | | | |
| Remote On/Off Control ③ | | | | | |
| "N" suffix | | | | | |
| Negative Logic, ON state | ON = Ground pin | -0.7 | | 0.8 | V |
| Negative Logic, OFF state | OFF = Pin open | 10 | | 15 | V |
| Control Current | Open collector/drain | | 1 | | mA |
| "P" suffix | | | | | |
| Positive Logic, ON state | ON = Pin open | 10 | | 15 | V |
| Positive Logic, OFF state | OFF = Ground pin | -0.7 | | 0.8 | V |
| Control Current | Open collector/drain | | 1 | | mA |

FUNCTIONAL SPECIFICATIONS, BPM15-120-Q48 (CONT.)

| OUTPUT | Conditions ① ③ | Minimum | Typical/Nominal | Maximum | Units |
|---|--|---------|---------------------|---------|-----------|
| Total Output Power | | 1.48 | 15 | 15.15 | W |
| Voltage | | | | | |
| Nominal Output Voltage | No trim | ±11.88 | ±12 | ±12.12 | Vdc |
| Setting Accuracy | At 50% load, no trim | | ±1 | | % of Vnom |
| Overvoltage Protection | Via magnetic feedback | 14.9 | 16 | 18 | Vdc |
| Current | | | | | |
| Output Current Range | | ±0.0625 | ±0.625 | ±0.625 | A |
| Current Limit Inception | 98% of Vnom., after warmup | ±0.75 | ±1.2 | ±1.45 | A |
| Short Circuit | | | | | |
| Short Circuit Current | Hiccup technique, autorecovery within ±1.25% of Vout | | | 0.3 | A |
| Short Circuit Duration (remove short for recovery) | Output shorted to ground, no damage | | Continuous | | |
| Short circuit protection method | Current limiting | | | | |
| Regulation | | | | | |
| Line Regulation | Vin = min. to max., Vout = nom., Iout = nom. | | | ±0.25 | % of Vout |
| Load Regulation | Iout = min. to max., Vin = 48V | | | ±0.25 | % of Vout |
| Ripple and Noise | 5 Hz- 20 MHz BW, Vin=48V | | 80 | 120 | mV pk-pk |
| Maximum Capacitive Loading | Low ESR, 0.02 ohms max | | | 150 | µF |
| MECHANICAL | | | | | |
| Outline Dimensions | | | 1 x 1 x 0.40 | | Inches |
| (Please refer to outline drawing) | WxLxH | | 25.4 x 25.4 x 10.16 | | mm |
| Weight | | | 0.69 | | Ounces |
| | | | 19.56 | | Grams |
| Through Hole Pin Diameter | | | 0.04 | | Inches |
| | | | 1.016 | | mm |
| Through Hole Pin Material | | | Copper alloy | | |
| TH Pin Plating Metal and Thickness | Nickel subplate | | 50 | | µ-inches |
| | Gold overplate | | 5 | | µ-inches |
| ENVIRONMENTAL | | | | | |
| Operating Ambient Temperature Range | See derating | -40 | | 85 | °C |
| Operating Case Temperature Range | No derating | -40 | | 108 | °C |
| Case Material | Tin plated steel with black powder coat | | | | |
| Storage Temperature | Vin = Zero (no power) | -55 | | 125 | °C |
| Thermal Protection/Shutdown | Measured in center | 120 | 130 | 140 | °C |
| Electromagnetic Interference | External filter is required | | | | |
| Conducted, EN55022/CISPR22 | | | B | | Class |
| RoHS rating | | | RoHS-6 | | |

Notes

① Unless otherwise noted, all specifications are at nominal input voltage, nominal output voltage and full load. General conditions are +25° Celsius ambient temperature, near sea level altitude, natural convection airflow. All models are tested and specified with external parallel 1 µF and 10 µF output capacitors. The external input capacitor is 100 µF.

② Input (back) ripple current is tested and specified over 5 Hz to 20 MHz bandwidth. Input filtering is Cbus = 220 µF, Cin = 33 µF and Lbus = 12 µH.

③ The Remote On/Off Control is referred to -Vin.

PERFORMANCE DATA, BPM15-120-Q48

Efficiency vs. Line Voltage and Load Current @ +25°C



Power Dissipation vs. Line Voltage and Load Current @ +25°C

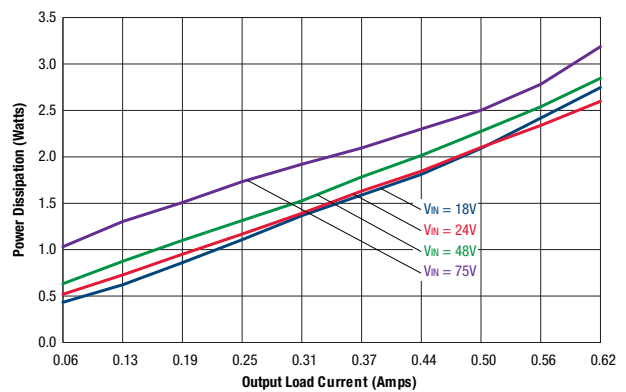

Maximum Current Temperature Derating at Sea Level (VIN = 18V, airflow is from pin 1 to pin 3)



Maximum Current Temperature Derating at Sea Level (VIN = 24V, airflow is from pin 1 to pin 3)

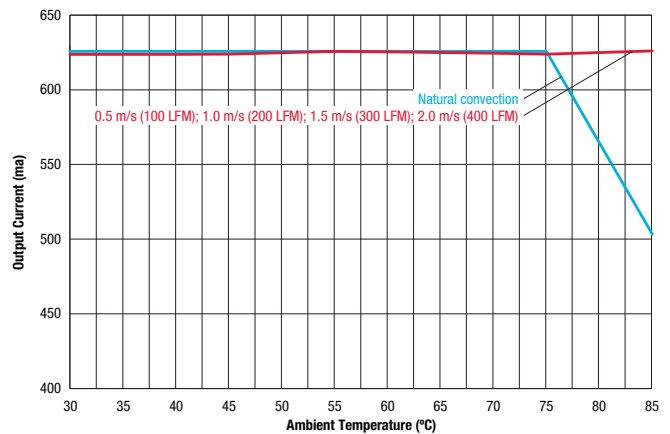

Maximum Current Temperature Derating at Sea Level (VIN = 48V, airflow is from pin 1 to pin 3)

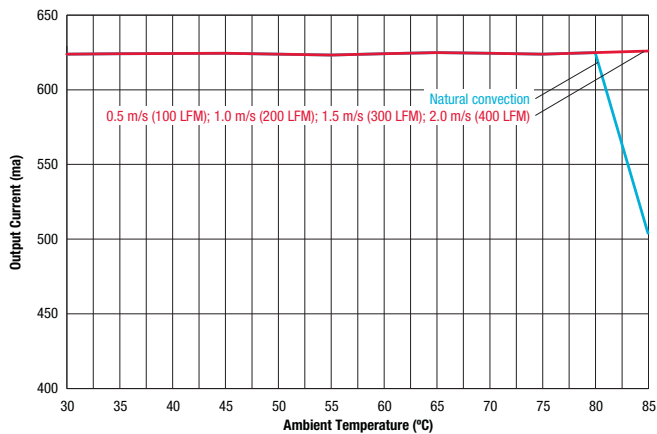

Maximum Current Temperature Derating at Sea Level (VIN = 75V, airflow is from pin 1 to pin 3)

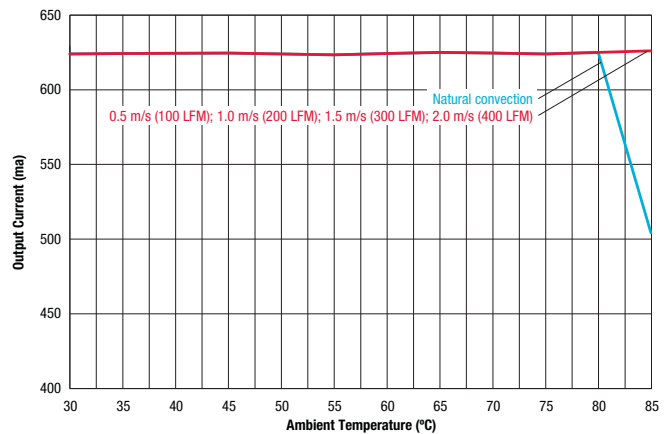

FUNCTIONAL SPECIFICATIONS, BPM15-150-Q48

| ABSOLUTE MAXIMUM RATINGS | Conditions ① | Minimum | Typical/Nominal | Maximum | Units |
|---|---|---------|-----------------|---------|-------------------------|
| Input Voltage, Continuous | | 0 | | 75 | Vdc |
| Input Voltage, Transient | 100 mS max. duration | | | 100 | Vdc |
| Isolation Voltage | Input to output | | | 1600 | Vdc |
| On/Off Remote Control | Power on, referred to -Vin | 0 | | 15 | Vdc |
| Output Power | | 1.485 | | 15.15 | W |
| Output Current | Current-limited, no damage, short-circuit protected | 0.05 | | 0.5 | A |
| Storage Temperature Range | Vin = Zero (no power) | -55 | | 125 | °C |
| Absolute maximums are stress ratings. Exposure of devices to greater than any of these conditions may adversely affect long-term reliability. Proper operation under conditions other than those listed in the Performance/Functional Specifications Table is not implied or recommended. | | | | | |
| INPUT | | | | | |
| Operating Voltage Range | | 18 | 48 | 75 | Vdc |
| Recommended External Fuse | Fast blow | | | 2 | A |
| Start-up Threshold | Rising input voltage | 16.25 | 16.8 | 17.5 | Vdc |
| Undervoltage Shutdown (50% load) | Falling input voltage | 15 | 16 | 17 | Vdc |
| Internal Filter Type | | | C | | |
| Input Current | | | | | |
| Full Load Input Current | Vin = nominal | | 0.36 | 0.38 | A |
| Low Line Input Current | Vin = minimum | | 0.97 | 1.01 | A |
| Inrush Transient | | | 0.05 | | A2-Sec. |
| Short Circuit Input Current | | | 0.05 | 0.1 | A |
| No Load Input Current | Iout = minimum, unit=ON | | 50 | 100 | mA |
| Shut-Down Input Current (Off, UV, OT) | | | 1 | 2 | mA |
| Reflected (Back) Ripple Current ② | Measured at input with specified filter | | 35 | | mA, p-p |
| GENERAL and SAFETY | | | | | |
| Efficiency | Vin = 48V, full load | 83.0 | 86.0 | | % |
| | Vin = min., full load | 83.0 | 85.5 | | % |
| Isolation | | | | | |
| Isolation Voltage | Input to output | | | 1600 | Vdc |
| Isolation Resistance | | 10 | | | MΩ |
| Isolation Capacitance | | | 700 | | pF |
| Safety | Certified to UL-60950-1, CSA-C22.2 No. 60950-1, IEC/60950-1, 2nd edition, with AM1 Per Telcordia SR332, issue 1, class 3, ground fixed, Tambient = +25°C | | Approved | | |
| Calculated MTBF | | | 5 | | Hours x 10 ⁶ |
| DYNAMIC CHARACTERISTICS | | | | | |
| Fixed Switching Frequency | | 290 | 320 | 350 | KHz |
| Startup Time | Power on to Vout regulated | | | 50 | mS |
| Startup Time | Remote ON to Vout regulated | | | 60 | mS |
| Dynamic Load Response | 50-75-50% load step, settling time to within 1% of Vout | | 250 | 300 | μSec |
| Dynamic Load Peak Deviation | same as above | | ±150 | ±250 | mV |
| FEATURES and OPTIONS | | | | | |
| Remote On/Off Control ③ | | | | | |
| "N" suffix | | | | | |
| Negative Logic, ON state | ON = Ground pin | -0.7 | | 0.8 | V |
| Negative Logic, OFF state | OFF = Pin open | 10 | | 15 | V |
| Control Current | Open collector/drain | | 1 | | mA |
| "P" suffix | | | | | |
| Positive Logic, ON state | ON = Pin open | 10 | | 15 | V |
| Positive Logic, OFF state | OFF = Ground pin | -0.7 | | 0.7 | V |
| Control Current | Open collector/drain | | 1 | | mA |

FUNCTIONAL SPECIFICATIONS, BPM15-150-Q48 (CONT.)

| OUTPUT | Conditions ① ③ | Minimum | Typical/Nominal | Maximum | Units |
|---|--|---------|---------------------|---------|-----------|
| Total Output Power | | 1.485 | 15.00 | 15.15 | W |
| Voltage | | | | | |
| Nominal Output Voltage | No trim | 14.850 | 15.00 | 15.150 | Vdc |
| Setting Accuracy | At 50% load, no trim | | 1 | | % of Vnom |
| Overvoltage Protection | Via magnetic feedback | 16 | 19 | 22 | Vdc |
| Current | | | | | |
| Output Current Range | | ±0.05 | ±0.5 | ±0.5 | A |
| Current Limit Inception | 98% of Vnom., after warmup | ±0.6 | ±1.1 | ±1.5 | A |
| Short Circuit | | | | | |
| Short Circuit Current | Hiccup technique, autorecovery within ±1.25% of Vout | | | 0.3 | A |
| Short Circuit Duration (remove short for recovery) | Output shorted to ground, no damage | | Continuous | | |
| Short circuit protection method | Current limiting | | | | |
| Regulation | | | | | |
| Line Regulation | Vin = min. to max., Vout = nom., Iout = nom. | | ±0.05 | ±0.25 | % of Vout |
| Load Regulation | Iout = min. to max., Vin = 48V | | ±0.075 | ±0.275 | % of Vout |
| Ripple and Noise | 5 Hz- 20 MHz BW, Vin=48V | | 80 | 120 | mV pk-pk |
| Maximum Capacitive Loading | Low ESR, 0.02 ohms max | | | 150 | µF |
| MECHANICAL | | | | | |
| Outline Dimensions | | | 1 x 1 x 0.40 | | Inches |
| (Please refer to outline drawing) | W x L x H | | 25.4 x 25.4 x 10.16 | | mm |
| Weight | | | 0.69 | | Ounces |
| | | | 19.56 | | Grams |
| Through Hole Pin Diameter | | | 0.04 | | Inches |
| | | | 1.016 | | mm |
| Through Hole Pin Material | | | Copper alloy | | |
| TH Pin Plating Metal and Thickness | Nickel subplate | | 50 | | µ-inches |
| | Gold overplate | | 5 | | µ-inches |
| ENVIRONMENTAL | | | | | |
| Operating Ambient Temperature Range | See derating | -40 | | 85 | °C |
| Operating Case Temperature Range | No derating | -40 | | 91 | °C |
| Case Material | Tin plated steel with black powder coat | | | | |
| Storage Temperature | Vin = Zero (no power) | -55 | | 125 | °C |
| Thermal Protection/Shutdown | Measured in center | 120 | 130 | 140 | °C |
| Electromagnetic Interference | External filter is required | | | | |
| Conducted, EN55022/CISPR22 | | | B | | Class |
| RoHS rating | | | RoHS-6 | | |

Notes

① Unless otherwise noted, all specifications are at nominal input voltage, nominal output voltage and full load. General conditions are +25° Celsius ambient temperature, near sea level altitude, natural convection airflow. All models are tested and specified with external parallel 1 µF and 10 µF output capacitors. The external input capacitor is 100 µF.

② Input (back) ripple current is tested and specified over 5 Hz to 20 MHz bandwidth. Input filtering is Cbus = 220 µF, Cin = 33 µF and Lbus = 12 µH.

③ The Remote On/Off Control is referred to -Vin.

PERFORMANCE DATA, BPM15-150-Q48

Efficiency vs. Line Voltage and Load Current @ +25°C



Power Dissipation vs. Line Voltage and Load Current @ +25°C



Maximum Current Temperature Derating at Sea Level
 (V_{IN} = 18V, 24V, 36V, 48V, 60V, 75V airflow is from pin 1 to pin 4)



MECHANICAL SPECIFICATIONS

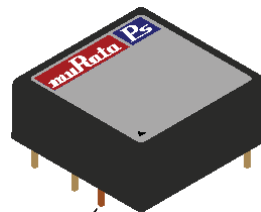
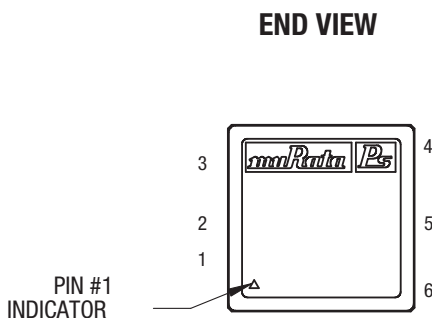

PIN #1

ISOMETRIC VIEW
(FOR REF ONLY)

MATERIAL:
Ø.040 PINS: COPPER ALLOY

FINISH: (ALL PINS)
GOLD (5µ"MIN) OVER NICKEL (50µ" MIN)

Standard pin length is shown. Please refer to the Part Number Structure for alternate pin lengths.

TOP VIEW

| INPUT/OUTPUT CONNECTIONS | |
|--------------------------|-----------------|
| Pin | Function |
| 1 | +Vin |
| 2 | -Vin |
| 3 | On/Off Control* |
| 4 | -Vout |
| 5 | Common |
| 6 | +Vout |

*The Remote On/Off pin is optional. It can be provided with positive logic (P suffix) or negative logic (N suffix). Please see the Part Number Structure on page 2.

Dimensions are in inches (mm shown for ref. only).

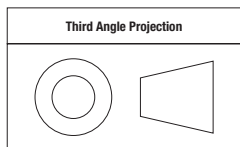

Tolerances (unless otherwise specified):
.XX ± 0.02 (0.5)
.XXX ± 0.010 (0.25)
Angles ± 1°

Components are shown for reference only.

RECOMMENDED FOOTPRINT FOR THRU-HOLE CONVERTER (VIEW THROUGH CONVERTER)



STANDARD PACKAGING

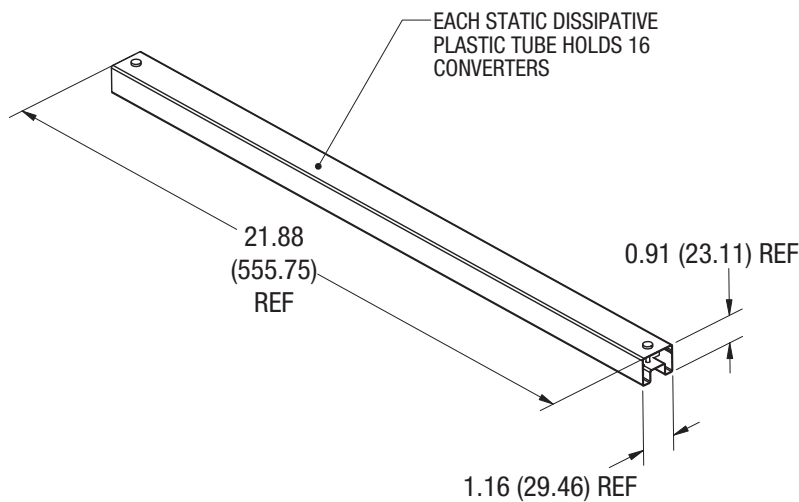

STANDARD PACKAGING FOR STANDARD THRU-HOLE CONVERTER

16 UNITS PER TUBE
6 TUBES PER CARTON

MPQ=16 UNITS
MOQ=96 UNITS

TECHNICAL NOTES

Input Fusing

Certain applications and/or safety agencies may require fuses at the inputs of power conversion components. Fuses should also be used when there is the possibility of sustained input voltage reversal which is not current-limited. For greatest safety, we recommend a fast blow fuse installed in the ungrounded input supply line.

The installer must observe all relevant safety standards and regulations. For safety agency approvals, install the converter in compliance with the end-user safety standard.

Input Under-Voltage Shutdown and Start-Up Threshold

Under normal start-up conditions, converters will not begin to regulate properly until the rising input voltage exceeds and remains at the Start-Up Threshold Voltage (see Specifications). Once operating, converters will not turn off until the input voltage drops below the Under-Voltage Shutdown Limit. Subsequent restart will not occur until the input voltage rises again above the Start-Up Threshold. This built-in hysteresis prevents any unstable on/off operation at a single input voltage.

Users should be aware however of input sources near the Under-Voltage Shutdown whose voltage decays as input current is consumed (such as poorly regulated capacitor inputs), the converter shuts off and then restarts as the external capacitor recharges. Such situations could oscillate. To prevent this, make sure the operating input voltage is well above the UV Shutdown voltage AT ALL TIMES.

Start-Up Delay

Assuming that the output current is set at the rated maximum, the Vin to Vout Start-Up Delay (see Specifications) is the time interval between the point when the rising input voltage crosses the Start-Up Threshold and the fully loaded regulated output voltage enters and remains within its specified regulation band. Actual measured times will vary with input source impedance, external input capacitance, input voltage slew rate and final value of the input voltage as it appears at the converter.

These converters include a soft start circuit to moderate the duty cycle of the PWM controller at power up, thereby limiting the input inrush current.

The On/Off Remote Control interval from inception to Vout regulated assumes that the converter already has its input voltage stabilized above the Start-Up Threshold before the On command. The interval is measured from the On command until the output enters and remains within its specified accuracy band. The specification assumes that the output is fully loaded at maximum rated current.

Recommended Input Filtering

The user must assure that the input source has low AC impedance to provide dynamic stability and that the input supply has little or no inductive content, including long distributed wiring to a remote power supply. The converter will operate with no additional external capacitance if these conditions are met.

For best performance, we recommend installing a low-ESR electrolytic capacitor immediately adjacent to the converter's input terminals. Initial suggested capacitor values are 10 to 22 μ F, rated at twice the expected maxi-

imum input voltage. Make sure that the input terminals do not go below the undervoltage shutdown voltage at all times. More input bulk capacitance may be added in parallel (either electrolytic or tantalum) if needed.

Recommended Output Filtering

The converter will achieve its rated output ripple and noise with no additional external capacitor. However, the user may install more external output capacitance to reduce the ripple even further or for improved dynamic response. Again, use low-ESR ceramic (Murata GRM32 series) or polymer capacitors. Initial values of 10 to 47 μ F may be tried, either single or multiple capacitors in parallel. Mount these close to the converter. Measure the output ripple under your load conditions.

Use only as much capacitance as required to achieve your ripple and noise objectives. Excessive capacitance can make step load recovery sluggish or possibly introduce instability. Do not exceed the maximum rated output capacitance listed in the specifications.

Input Ripple Current and Output Noise

All models in this converter series are tested and specified for input reflected ripple current and output noise using designated external input/output components, circuits and layout as shown in the figures below. The Cbus and Lbus components simulate a typical DC voltage bus. Please note that the values of Cin, Lbus and Cbus may vary according to the specific converter model.

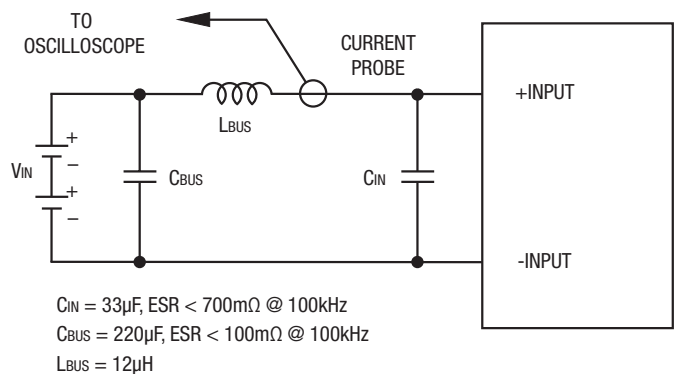

Figure 2: Measuring Input Ripple Current



Figure 3: Measuring Output Ripple and Noise (PARD)

Minimum Output Loading Requirements

All models regulate within specification and are stable under 10% minimum load to full load conditions. Operation under no load might however slightly increase output ripple and noise.

Thermal Shutdown

To protect against thermal overstress, these converters include thermal shutdown circuitry. If environmental conditions cause the temperature of the DC-DC's to rise above the Operating Temperature Range up to the shutdown temperature, an on-board electronic temperature sensor will power down the unit. When the temperature decreases below the turn-on threshold, the converter will automatically restart. There is a small amount of temperature hysteresis to prevent rapid on/off cycling.

CAUTION: If you operate too close to the thermal limits, the converter may shut down suddenly without warning. Be sure to thoroughly test your application to avoid unplanned thermal shutdown.

Temperature Derating Curves

The graphs in this data sheet illustrate typical operation under a variety of conditions. The Derating curves show the maximum continuous ambient air temperature and decreasing maximum output current which is acceptable under increasing forced airflow measured in Linear Feet per Minute ("LFM"). Note that these are AVERAGE measurements. The converter will accept brief increases in current or reduced airflow as long as the average is not exceeded.

Note that the temperatures are of the ambient airflow, not the converter itself which is obviously running at higher temperature than the outside air. Also note that very low flow rates (below about 65 LFM) are similar to "natural convection", that is, not using fan-forced airflow.

Murata Power Solutions makes Characterization measurements in a closed cycle wind tunnel with calibrated airflow. We use both thermocouples and an infrared camera system to observe thermal performance.

CAUTION: If you exceed these Derating guidelines, the converter may have an unplanned Over Temperature shut down. Also, these graphs are all collected near Sea Level altitude. Be sure to reduce the derating for higher altitude.

Output Current Limiting

Current limiting inception is defined as the point at which full power falls below the rated tolerance. See the Performance/Functional Specifications. Note particularly that the output current may briefly rise above its rated value in normal operation as long as the average output power is not exceeded. This enhances reliability and continued operation of your application. If the output current is too high, the converter will enter the short circuit condition.

Output Short Circuit Condition

When a converter is in current-limit mode, the output voltage will drop as the output current demand increases. If the output voltage drops too low (approximately 98% of nominal output voltage for most models), the PWM controller will shut down. Following a time-out period, the PWM will restart, causing the output voltage to begin rising to its appropriate value. If the short-circuit condition persists, another shutdown cycle will initiate. This rapid on/off cycling is called "hiccup mode". The hiccup cycling reduces the average output current, thereby preventing excessive internal temperatures and/or component damage.

Remote On/Off Control

The remote On/Off Control can be specified with either logic logic type. Please refer to the Connection Diagram on page 1 for On/Off connections.

Positive-logic models are enabled when the On/Off pin is left open or is pulled high to +Vin with respect to -Vin. Therefore, the On/Off control can be disconnected if the converter should always be on. Positive-logic devices are disabled when the On/Off is grounded or brought to within a low voltage (see Specifications) with respect to -Vin.

Negative-logic devices are on (enabled) when the On/Off pin is grounded or brought to within a low voltage (see Specifications) with respect to -Vin. The device is off (disabled) when the On/Off is pulled high (see Specifications) with respect to -Vin.

Dynamic control of the On/Off function must sink the specified signal current when brought low and withstand the specified voltage when brought high. Be aware too that there is a finite time in milliseconds (see Specifications) between the time of On/Off Control activation and stable, regulated output. This time will vary slightly with output load type and current and input conditions.

Output Capacitive Load

These converters do not require external capacitance added to achieve rated specifications. Users should only consider adding capacitance to reduce switching noise and/or to handle spike current load steps. Install only enough capacitance to achieve your noise and surge response objectives. Excess external capacitance may cause regulation problems and possible oscillation or instability.

The maximum rated output capacitance and ESR specification is given for a capacitor installed immediately adjacent to the converter.

Floating Outputs

Since these are isolated DC-DC converters, their outputs are "floating." Any BPM15 model may be configured to produce an output of 10V, 24V or 30V (for ±5V, ±12V or ±15V models, respectively) by applying the load across the +Output and -Output pins, with either output grounded. The Common pin should be left open. Minimum 10% loading is recommended under these conditions.

Soldering Guidelines

Murata Power Solutions recommends the specifications below when installing these converters. These specifications vary depending on the solder type. Exceeding these specifications may cause damage to the product. Your production environment may differ; therefore please thoroughly review these guidelines with your process engineers.

Wave Solder Operations for through-hole mounted products (THMT)

For Sn/Ag/Cu based solders:

| | |
|-----------------------------|-----------|
| Maximum Preheat Temperature | 115° C. |
| Maximum Pot Temperature | 270° C. |
| Maximum Solder Dwell Time | 7 seconds |

For Sn/Pb based solders:

| | |
|-----------------------------|-----------|
| Maximum Preheat Temperature | 105° C. |
| Maximum Pot Temperature | 250° C. |
| Maximum Solder Dwell Time | 6 seconds |

Emissions Performance

Murata Power Solutions measures its products for radio frequency emissions against the EN 55022 and CISPR 22 standards. Passive resistance loads are employed and the output is set to the maximum voltage. If you set up your own emissions testing, make sure the output load is rated at continuous power while doing the tests.

The recommended external input and output capacitors (if required) are included. Please refer to the fundamental switching frequency. All of this information is listed in the Product Specifications. An external discrete filter is installed and the circuit diagram is shown below.

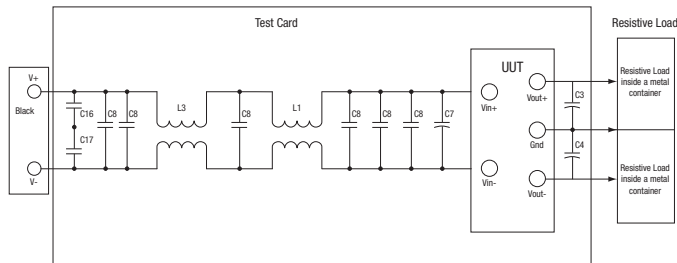

Figure 4. Conducted Emissions Test Circuit

[1] Conducted Emissions Parts List

| Reference | Description |
|------------|-------------------------------------|
| L1 | 1mH, 6A |
| L3 | 500μH, 10A |
| C1, C2, C8 | 2.2μfd |
| C7 | Electrolytic Capacitor 100μfd, 100V |
| C16, C17 | .22μfd |
| C3, C4 | Electrolytic Capacitor 33μfd, 100V |

[2] Conducted Emissions Test Equipment Used

- Rohde & Schwarz EMI Test Receiver (9KHz – 1000MHz) ESPC
- Rohde & Schwarz Software ESPC-1 Ver. 2.20
- OHMITE 25W – 1 Ohm resistor combinations
- DC Source Programmable DC Power Supply Model 62012P-100-50

[3] Conducted Emissions Test Results

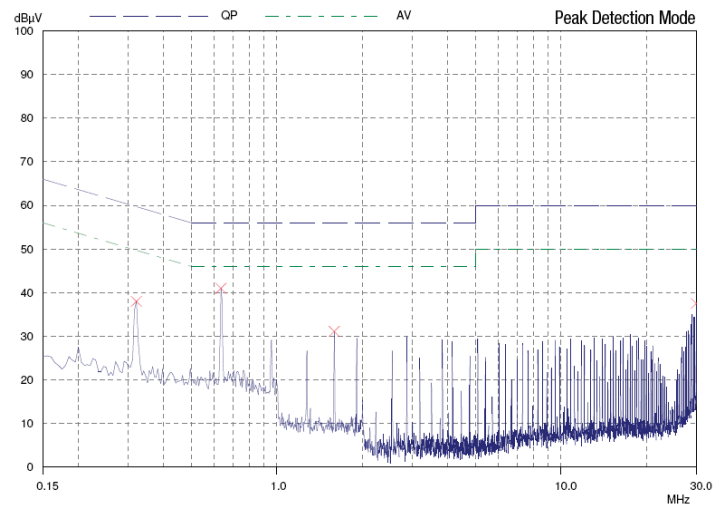

Graph 1. Conducted emissions performance with filter, CISPR 22, Class B, full load, for BPM15-150-Q12P-C

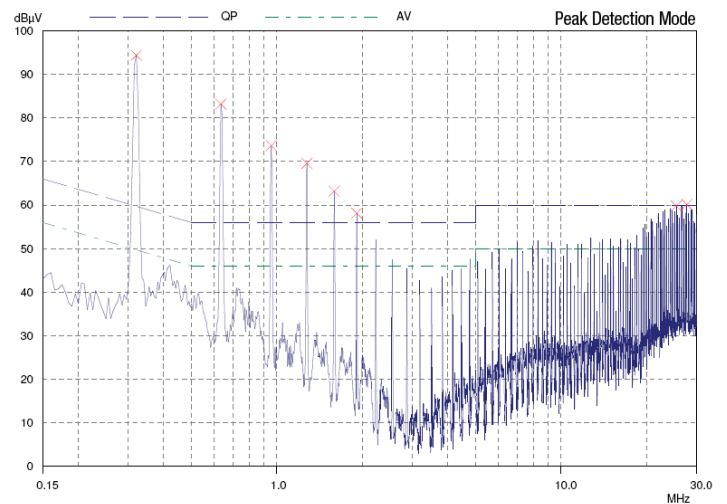

Graph 2. Conducted emissions performance without filter, CISPR 22, Class B, full load, for BPM15-150-Q12P-C

Murata Power Solutions, Inc.
 11 Cabot Boulevard, Mansfield, MA 02048-1151 U.S.A.
 ISO 9001 and 14001 REGISTERED



This product is subject to the following [operating requirements](#) and the [Life and Safety Critical Application Sales Policy](#). Refer to: <http://www.murata-ps.com/requirements/>

Murata Power Solutions, Inc. makes no representation that the use of its products in the circuits described herein, or the use of other technical information contained herein, will not infringe upon existing or future patent rights. The descriptions contained herein do not imply the granting of licenses to make, use, or sell equipment constructed in accordance therewith. Specifications are subject to change without notice. © 2016 Murata Power Solutions, Inc.



Компания «ЭлектроПласт» предлагает заключение долгосрочных отношений при поставках импортных электронных компонентов на взаимовыгодных условиях!

Наши преимущества:

- Оперативные поставки широкого спектра электронных компонентов отечественного и импортного производства напрямую от производителей и с крупнейших мировых складов;
- Поставка более 17-ти миллионов наименований электронных компонентов;
- Поставка сложных, дефицитных, либо снятых с производства позиций;
- Оперативные сроки поставки под заказ (от 5 рабочих дней);
- Экспресс доставка в любую точку России;
- Техническая поддержка проекта, помощь в подборе аналогов, поставка прототипов;
- Система менеджмента качества сертифицирована по Международному стандарту ISO 9001;
- Лицензия ФСБ на осуществление работ с использованием сведений, составляющих государственную тайну;
- Поставка специализированных компонентов (Xilinx, Altera, Analog Devices, Intersil, Interpoint, Microsemi, Aeroflex, Peregrine, Syfer, Eurofarad, Texas Instrument, Miteq, Cobham, E2V, MA-COM, Hittite, Mini-Circuits, General Dynamics и др.);

Помимо этого, одним из направлений компании «ЭлектроПласт» является направление «Источники питания». Мы предлагаем Вам помощь Конструкторского отдела:

- Подбор оптимального решения, техническое обоснование при выборе компонента;
- Подбор аналогов;
- Консультации по применению компонента;
- Поставка образцов и прототипов;
- Техническая поддержка проекта;
- Защита от снятия компонента с производства.



Как с нами связаться

Телефон: 8 (812) 309 58 32 (многоканальный)

Факс: 8 (812) 320-02-42

Электронная почта: org@eplast1.ru

Адрес: 198099, г. Санкт-Петербург, ул. Калинина, дом 2, корпус 4, литера А.