

**32 – 45 GHz Wide Band Driver Amplifier**

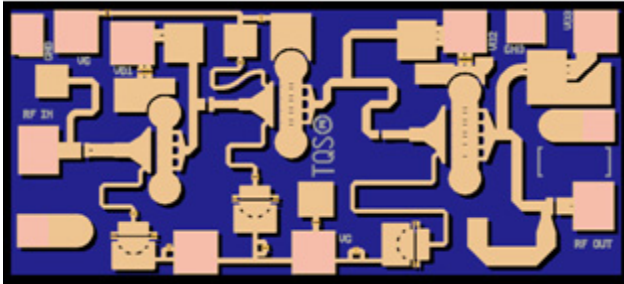

**Key Features**

- Frequency Range: 32 - 45 GHz
- 25 dBm Nominal Psat @ 38 GHz
- 24 dBm P1dB @ 38 GHz
- 16 dB Nominal Gain @ 38 GHz
- 33 dBm OTOI @ 16dB/Tone
- Bias: 6 V @ 175 mA Idq
- 0.15 um 3MI pHEMT Technology
- Chip Dimensions 1.60 x 0.75 x 0.10 mm (0.063 x 0.030 x 0.004 in)

**Measured Fixtured Data**

Bias Conditions: Vd = 6 V, Idq = 175 mA

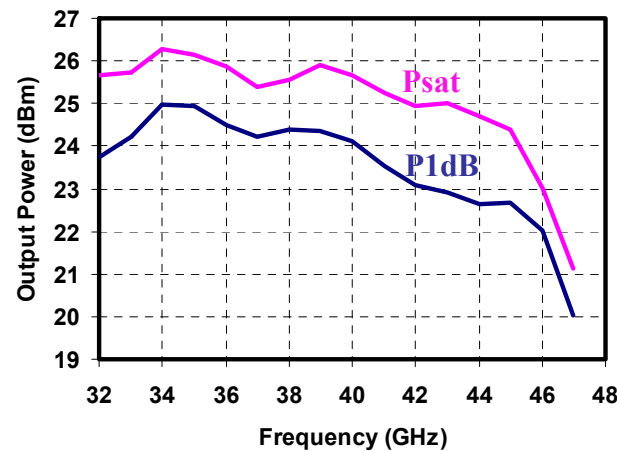
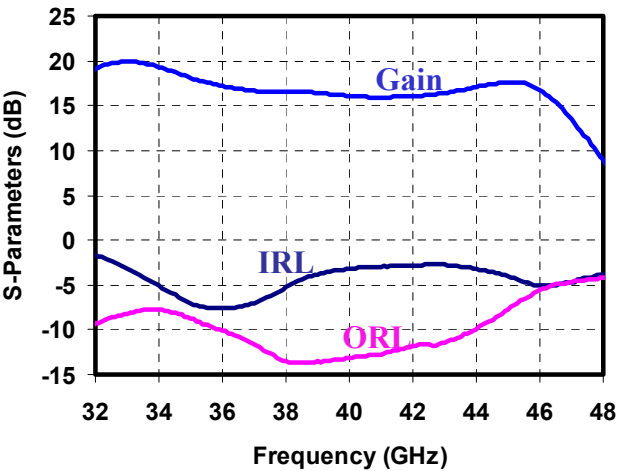

**Primary Applications**

- Digital Radio
- Point-to-Point Radio
- Point-to-Multipoint Communications
- Military SAT-COM

**Product Description**

The TriQuint TGA4521 is a compact Driver Amplifier MMIC for Ka-band and Q-band applications. The part is designed using TriQuint's 0.15um power pHEMT production process.

The TGA4521 nominally provides 25 dBm saturated output power, and 24 dBm output power at 1dB Gain compression @ 38 GHz. It also has typical gain of 16 dB.

The part is ideally suited for low cost emerging markets such as Digital Radio, Point-to-Point Radio and Point-to-Multi Point Communications.

The TGA4521 is 100% DC and RF tested on-wafer to ensure performance compliance.

Lead-Free & RoHS compliant.

Evaluation boards are available upon request.

**TABLE I  
 MAXIMUM RATINGS 1/**

<b>SYMBOL</b>	<b>PARAMETER</b>	<b>VALUE</b>	<b>NOTES</b>
V <sub>d</sub>	Drain Voltage	6.5 V	<u>2/</u>
V <sub>g</sub>	Gate Voltage Range	-2 TO 0 V	
I <sub>d</sub>	Drain Current	350 mA	<u>2/ 3/</u>
I <sub>g</sub>	Gate Current	9 mA	<u>3/</u>
P <sub>IN</sub>	Input Continuous Wave Power	20 dBm	
P <sub>D</sub>	Power Dissipation	See note <u>4/</u>	<u>2/</u>
T <sub>CH</sub>	Operating Channel Temperature	150 °C	<u>5/ 6/</u>
T <sub>M</sub>	Mounting Temperature (30 Seconds)	320 °C	
T <sub>STG</sub>	Storage Temperature	-65 to 150 °C	

1/ These ratings represent the maximum operable values for this device.

2/ Combinations of supply voltage, supply current, input power, and output power shall not exceed P<sub>D</sub>

3/ Total current for the entire MMIC.

4/ For a median life time of 1E+6 hrs, Power dissipation is limited to:

$$P_{D(max)} = (150\text{ }^{\circ}\text{C} - T_{BASE}\text{ }^{\circ}\text{C}) / 70\text{ (}^{\circ}\text{C/W)}$$

Where T<sub>BASE</sub> is the base plate temperature.

5/ Junction operating temperature will directly affect the device median time to failure (MTTF). For maximum life, it is recommended that junction temperatures be maintained at the lowest possible levels.

6/ These ratings apply to each individual FET.

**TABLE II**  
**ELECTRICAL CHARACTERISTICS**  
(Ta = 25 °C Nominal)

PARAMETER	FREQUENCY (GHz)	MIN	TYPICAL	UNITS
Frequency Range			32 - 45	GHz
Drain Voltage, Vd			6.0	V
Drain Current, Id			175	mA
Gate Voltage, Vg			-0.7	V
Small Signal Gain, S21	32	14.5	20	dB
	36 - 38	15.5	17	
	44	14	17	
Input Return Loss, S11	32	1	1.5	dB
	36	3.5	8	
	38	2.5	5	
	44	2	3	
Output Return Loss, S22	32 - 38	8	10	dB
	44	4	10	
Output Power @ 1dB Gain Compression, P1dB	38	24	24.5	dBm
	32 - 45		23.5	
Saturated Power, Psat			25	dBm
OTOI @ Pin = 1dBm	38	31	33	dBm
	32 - 45		33	

**TABLE III**  
**THERMAL INFORMATION**

PARAMETER	TEST CONDITIONS	T <sub>CH</sub> (°C)	R <sub>θJC</sub> (°C/W)	T <sub>M</sub> (HRS)
R <sub>θJC</sub> Thermal Resistance (channel to Case)	Vd = 6 V Id = 175 mA Pdiss = 1.05 W	144	70	2.0E+6

Note: Assumes eutectic attach using 1.5 mil 80/20 AuSn mounted to a 20 mil CuMo Carrier at 70 °C baseplate temperature. Worst case condition with no RF applied, 100% of DC power is dissipated.

**Measured Data**

Bias Conditions:  $V_d = 6\text{ V}$ ,  $I_{dq} = 175\text{ mA}$

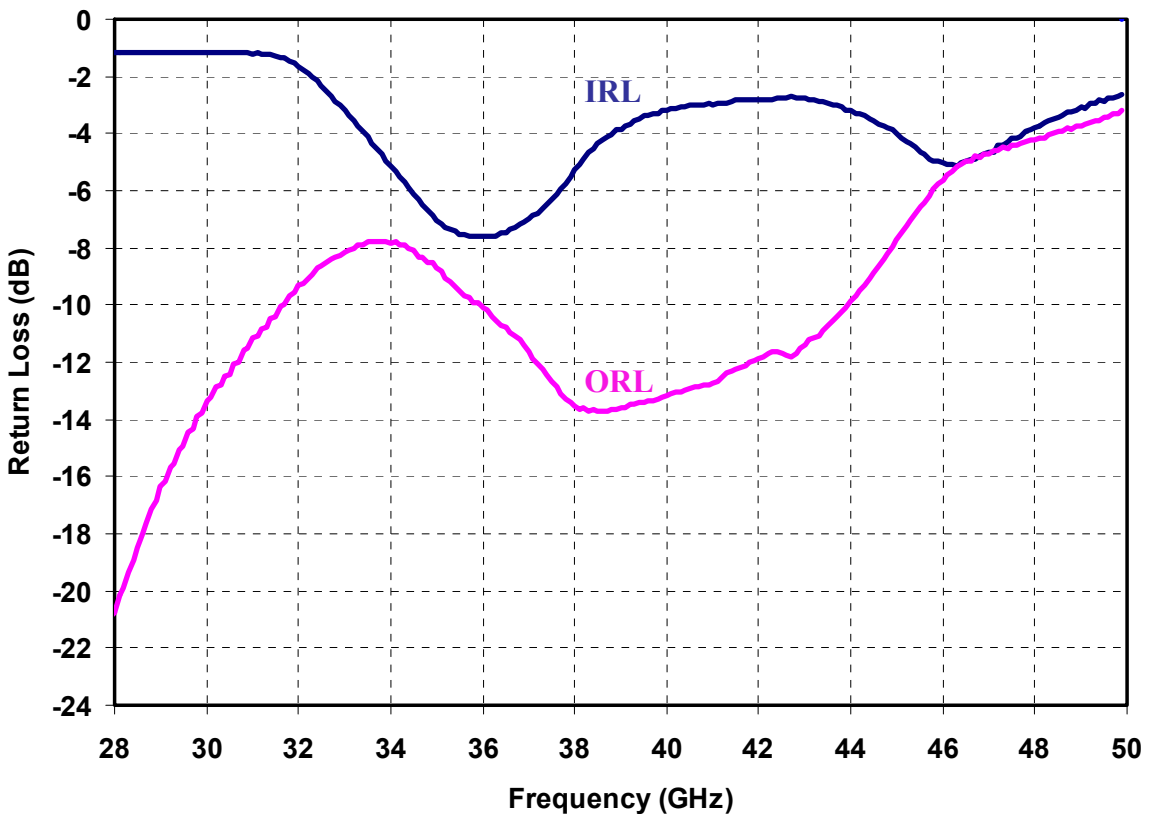
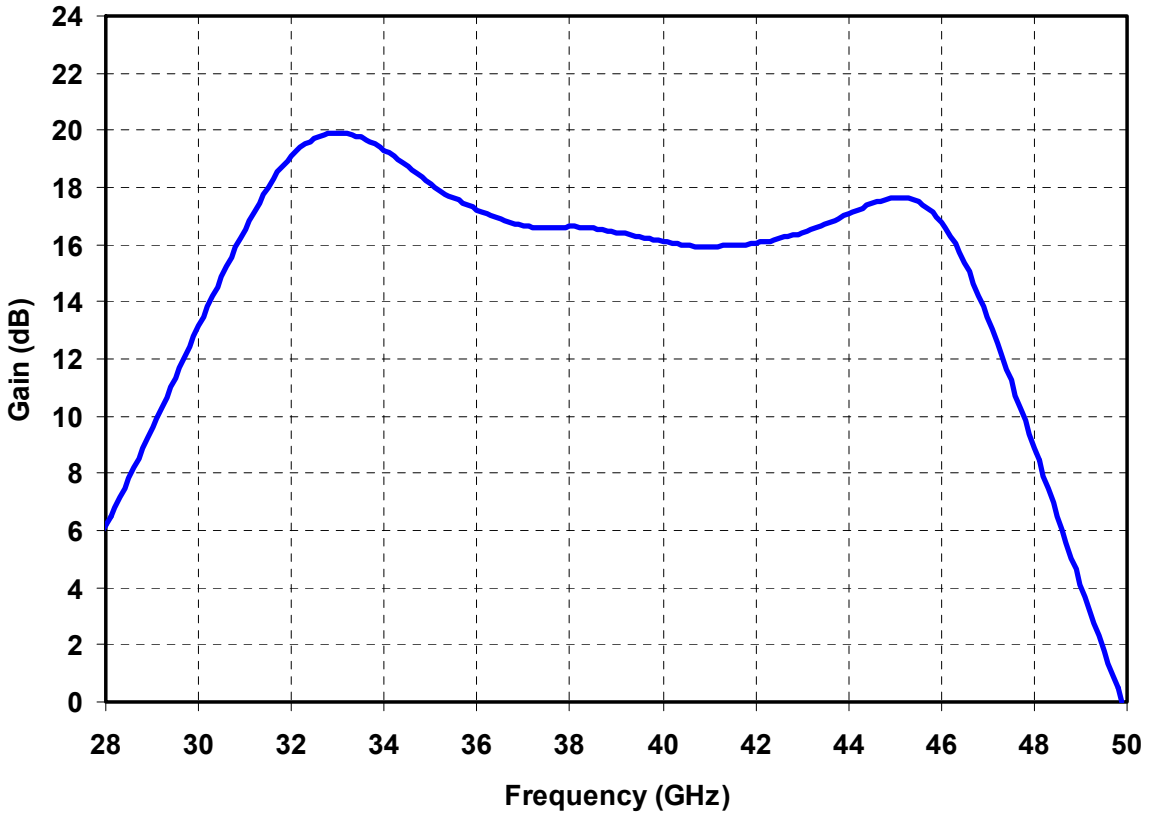

**Measured Data**

Bias Conditions:  $V_d = 6\text{ V}$ ,  $I_{dq} = 175\text{ mA}$

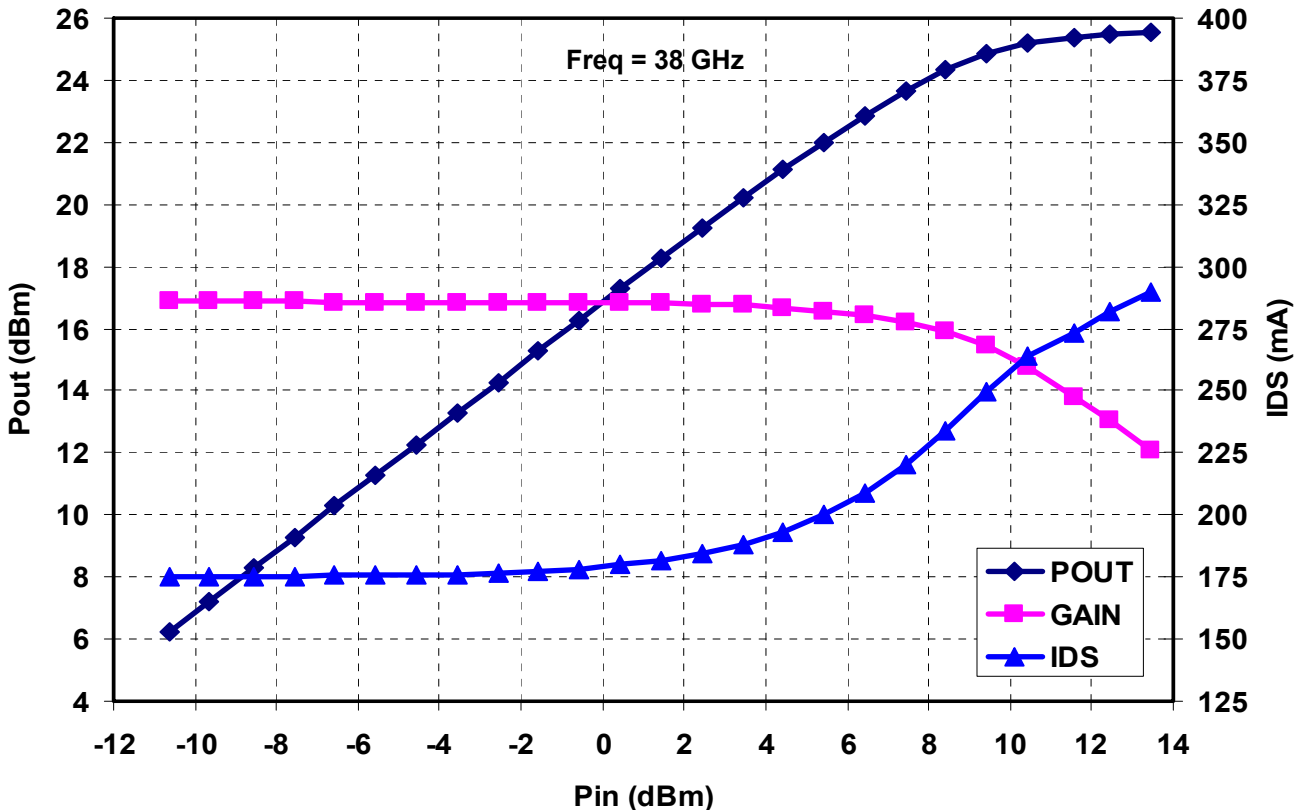
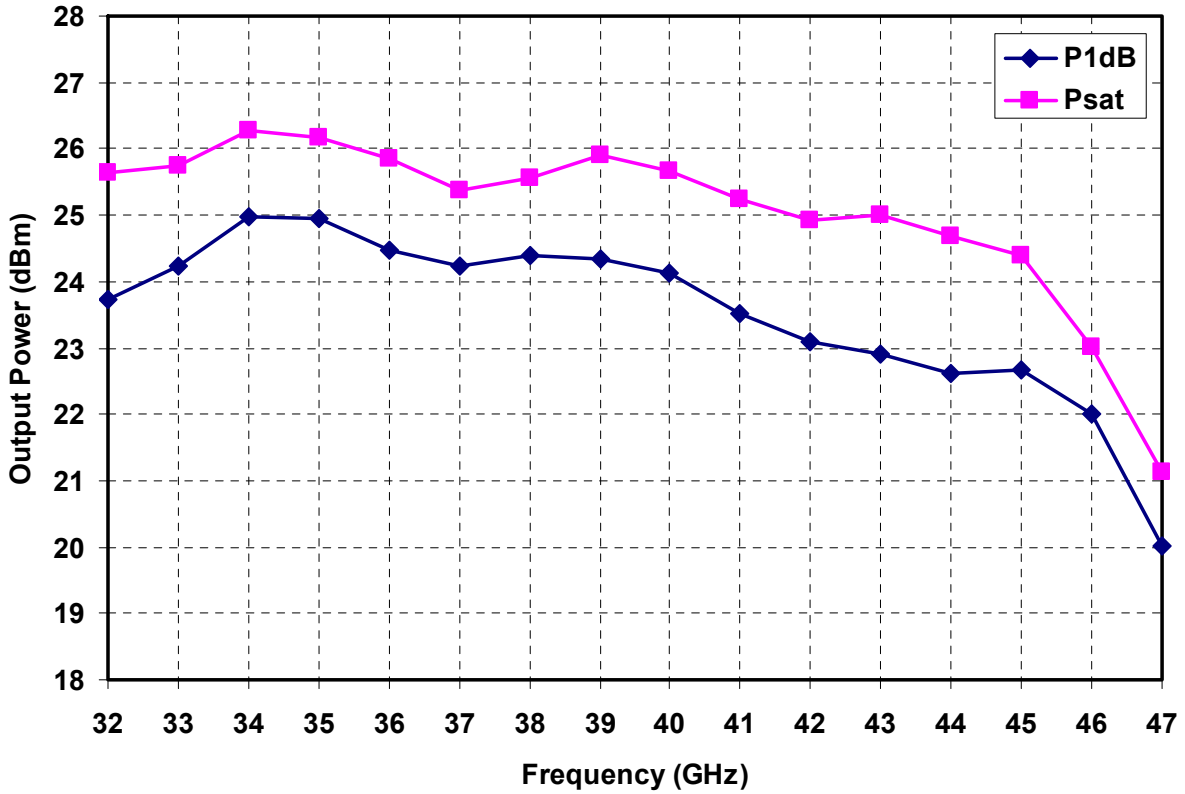

**Measured Data**

Bias Conditions:  $V_d = 6\text{ V}$ ,  $I_{dq} = 175\text{ mA}$ ,  $\Delta f = 10\text{ MHz}$

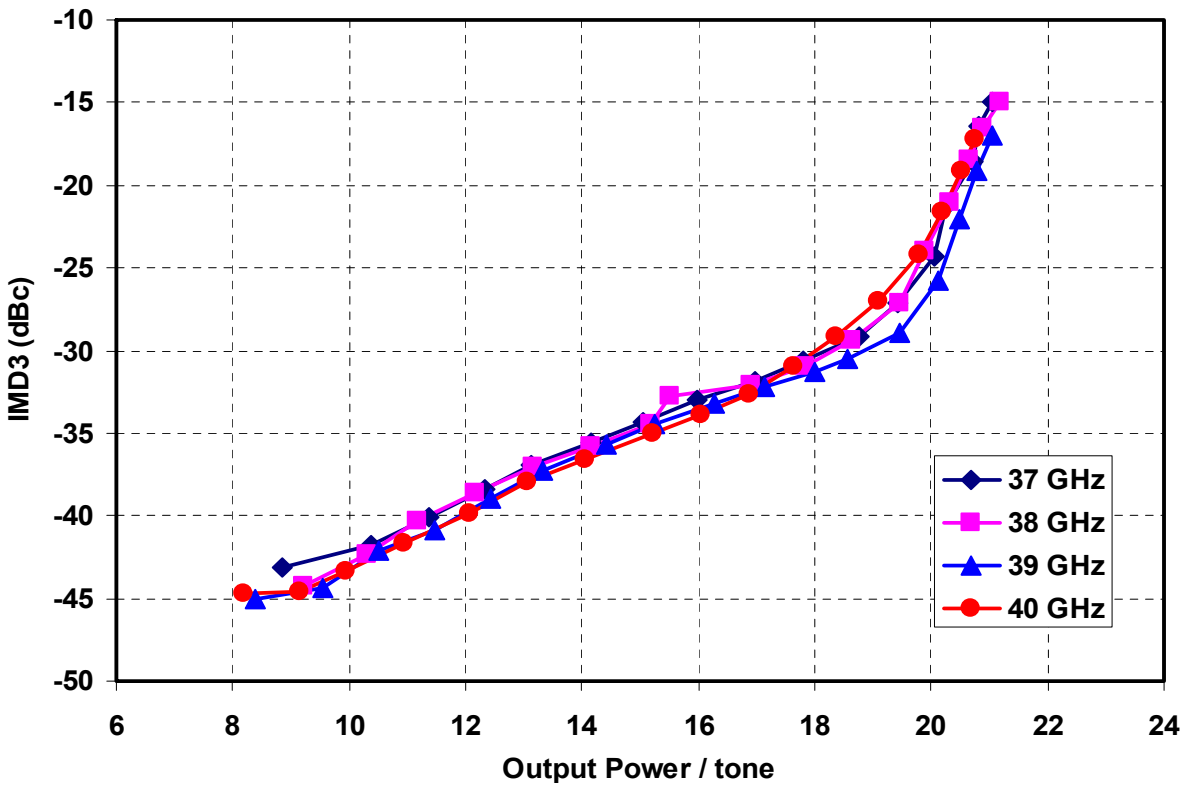
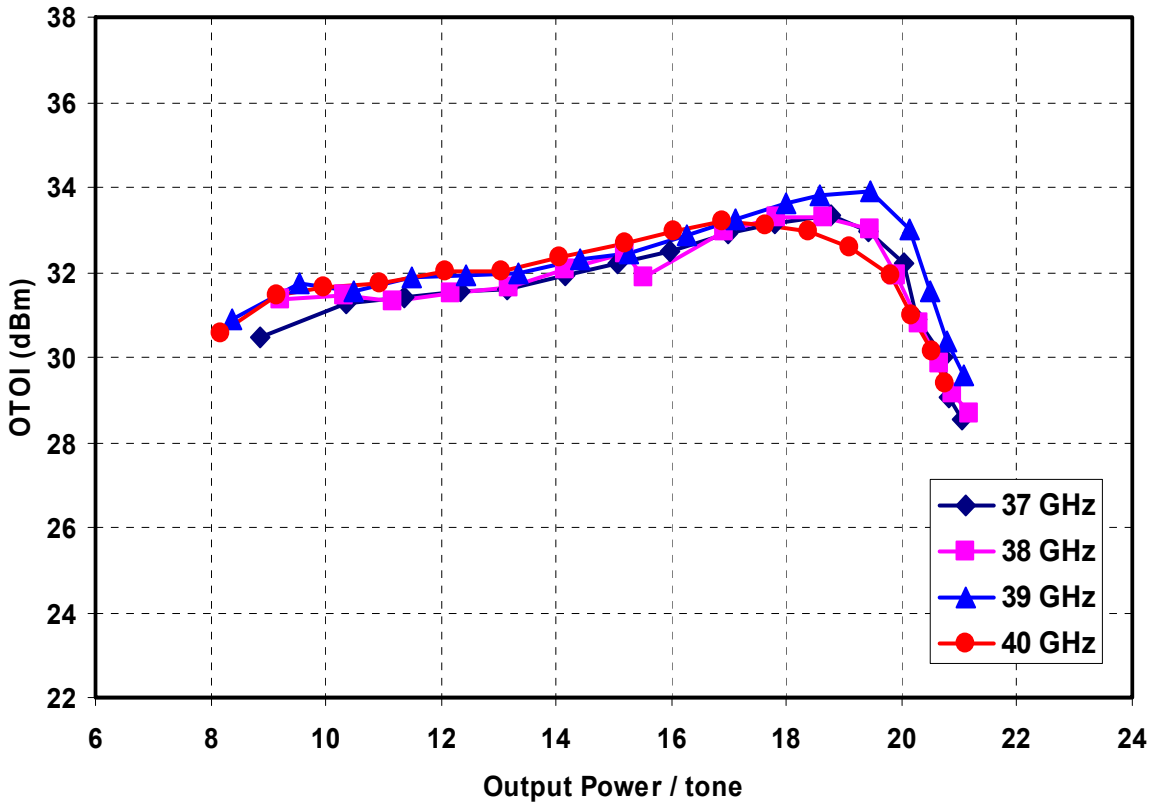

**Mechanical Drawing**

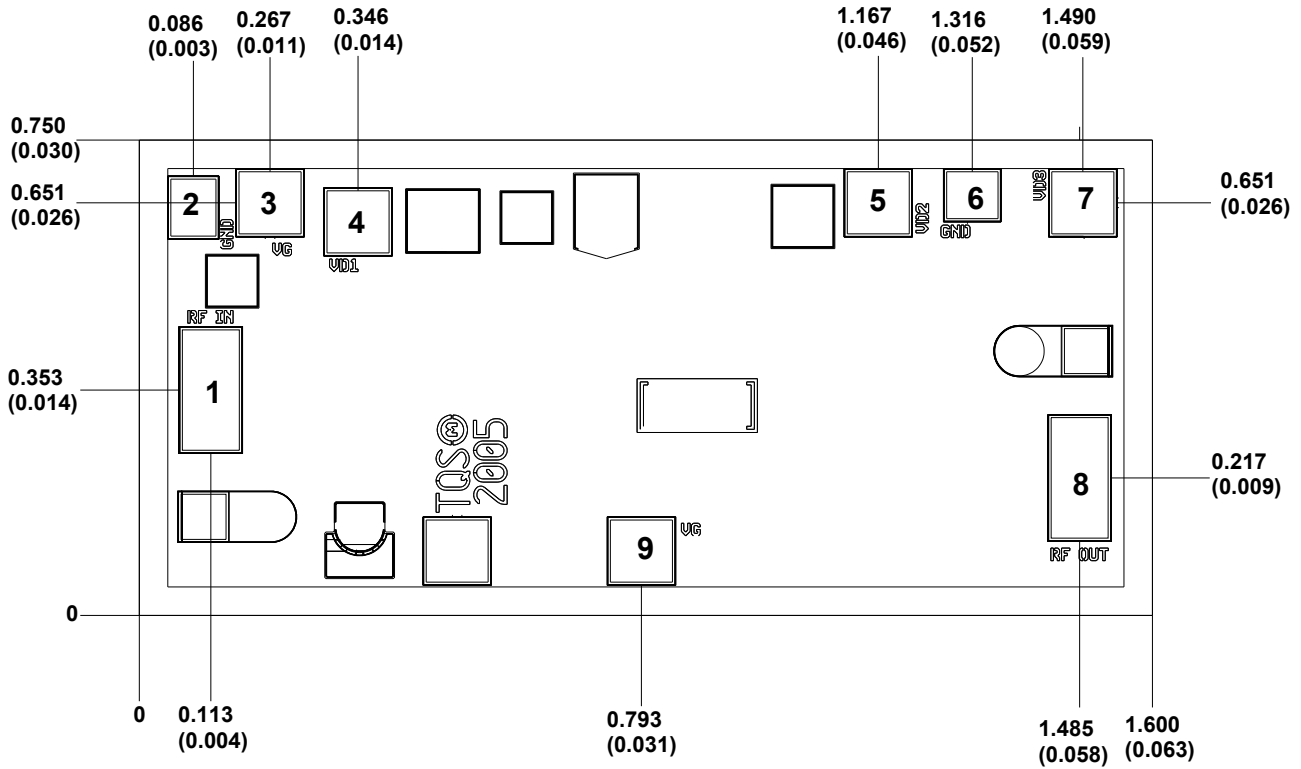

Units: millimeters (inches)

Thickness: 0.100 (0.004)

Chip edge to bond pad dimensions are shown to center of bond pad

Chip size tolerance: +/- 0.051 (0.002)

GND is back side of MMIC

Bond pad #1	(RF In)	0.100 x 0.200	(0.004 x 0.008)
Bond pad #2	(N/C)	0.081 x 0.100	(0.003 x 0.004)
Bond pad #3, 9	(Vg)	0.108 x 0.108	(0.004 x 0.004)
Bond pad #4, 5, 7	(Vd)	0.108 x 0.108	(0.004 x 0.004)
Bond pad #6	(N/C)	0.091 x 0.084	(0.004 x 0.003)
Bond pad #8	(RF Out)	0.100 x 0.200	(0.004 x 0.008)

**GaAs MMIC devices are susceptible to damage from Electrostatic Discharge. Proper precautions should be observed during handling, assembly and test.**

**Recommended Chip Assembly Diagram**

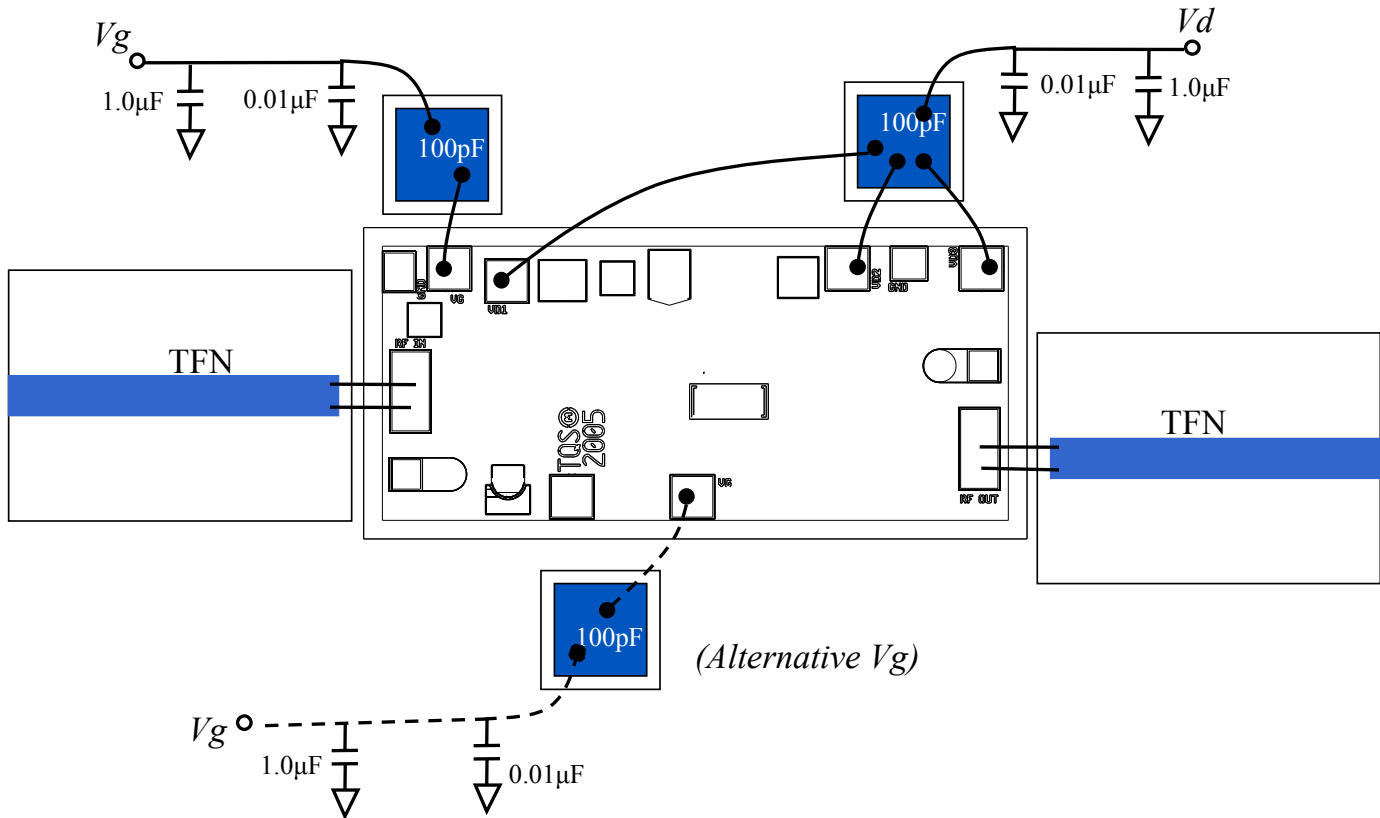

**Bias Conditions:  $V_d = 6\text{ V}$   
 $V_g = \sim -0.7\text{ V}$  to get 175mA  $I_d$**

**GaAs MMIC devices are susceptible to damage from Electrostatic Discharge. Proper precautions should be observed during handling, assembly and test.**



## Assembly Process Notes

Component placement and adhesive attachment assembly notes:

- Vacuum pencils and/or vacuum collets are the preferred method of pick up.
- Air bridges must be avoided during placement.
- The force impact is critical during auto placement.
- Organic attachment (i.e. epoxy) can be used in low-power applications.
- Curing should be done in a convection oven; proper exhaust is a safety concern.

Reflow process assembly notes:

- Use AuSn (80/20) solder and limit exposure to temperatures above 300°C to 3-4 minutes, maximum.
- An alloy station or conveyor furnace with reducing atmosphere should be used.
- Do not use any kind of flux.
- Coefficient of thermal expansion matching is critical for long-term reliability.
- Devices must be stored in a dry nitrogen atmosphere.

Interconnect process assembly notes:

- Ball bonding is the preferred interconnect technique, except where noted on the assembly diagram.
- Force, time, and ultrasonics are critical bonding parameters.
- Aluminum wire should not be used.
- Devices with small pad sizes should be bonded with 0.0007-inch wire.

## Ordering Information

Part	Package Style
TGA4521	GaAs MMIC Die

***GaAs MMIC devices are susceptible to damage from Electrostatic Discharge. Proper precautions should be observed during handling, assembly and test.***



Компания «ЭлектроПласт» предлагает заключение долгосрочных отношений при поставках импортных электронных компонентов на взаимовыгодных условиях!

Наши преимущества:

- Оперативные поставки широкого спектра электронных компонентов отечественного и импортного производства напрямую от производителей и с крупнейших мировых складов;
- Поставка более 17-ти миллионов наименований электронных компонентов;
- Поставка сложных, дефицитных, либо снятых с производства позиций;
- Оперативные сроки поставки под заказ (от 5 рабочих дней);
- Экспресс доставка в любую точку России;
- Техническая поддержка проекта, помощь в подборе аналогов, поставка прототипов;
- Система менеджмента качества сертифицирована по Международному стандарту ISO 9001;
- Лицензия ФСБ на осуществление работ с использованием сведений, составляющих государственную тайну;
- Поставка специализированных компонентов (Xilinx, Altera, Analog Devices, Intersil, Interpoint, Microsemi, Aeroflex, Peregrine, Syfer, Eurofarad, Texas Instrument, Miteq, Cobham, E2V, MA-COM, Hittite, Mini-Circuits, General Dynamics и др.);

Помимо этого, одним из направлений компании «ЭлектроПласт» является направление «Источники питания». Мы предлагаем Вам помощь Конструкторского отдела:

- Подбор оптимального решения, техническое обоснование при выборе компонента;
- Подбор аналогов;
- Консультации по применению компонента;
- Поставка образцов и прототипов;
- Техническая поддержка проекта;
- Защита от снятия компонента с производства.



#### Как с нами связаться

**Телефон:** 8 (812) 309 58 32 (многоканальный)

**Факс:** 8 (812) 320-02-42

**Электронная почта:** [org@eplast1.ru](mailto:org@eplast1.ru)

**Адрес:** 198099, г. Санкт-Петербург, ул. Калинина, дом 2, корпус 4, литера А.