

SWITCHING REGULATOR CONTROL IC FOR FLYBACK

■ GENERAL DESCRIPTION

The NJM2368 is a high speed switching regulator control IC which can operate at low voltage.

It uses a totempole output circuit, so that it can drive an external Bipolar Transistor directly.

It is suitable for applications of flyback type switching regulation of up to 10W.

■ PACKAGE OUTLINE

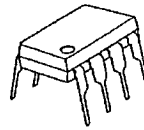

NJM2368D



NJM2368M

■ FEATURES

- Operating Voltage (3.6~32V)
- Wide Oscillator Range (5~350 kHz)
- Soft-Start Function.
- Under Voltage Lockouts (U.V.L.O.)
- Bipolar Technology
- Package Outline DIP8, DMP8, EMP8, SSOP8



NJM2368E



NJM2368V

■ BLOCK DIAGRAM

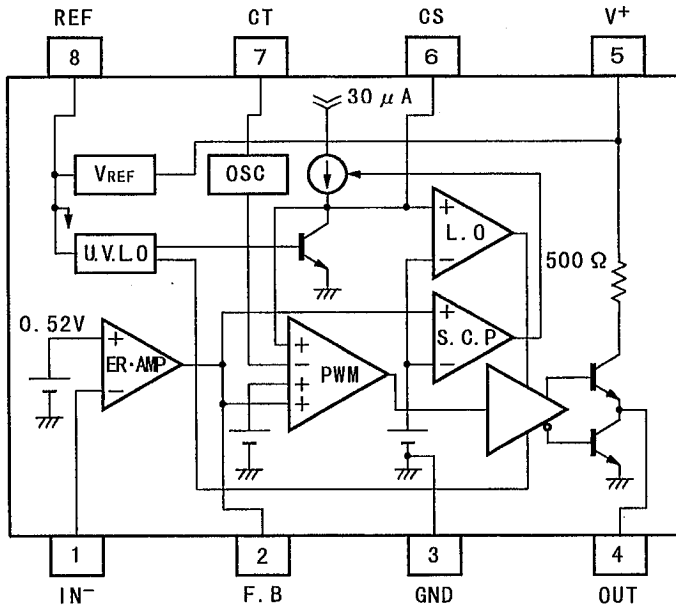

- PIN FUNCTION
1. IN⁻
 2. F. B
 3. GND
 4. OUT
 5. V⁺
 6. CS
 7. CT
 8. REF



■ ABSOLUTE MAXIMUM RATINGS (T_a = 25°C)

PARAMETER	SYMBOL	MAXIMUM RATINGS	UNIT
Input Voltage	V ⁺	36	V
Reference Output Current	I _{OR}	10	mA
Output Current	I _O	±50	mA
Power Dissipation	P _D	(DIP8) 700 (DMP8) 300 (EMP8) 300 (SSOP8) 250	mW
Operating Temperature Range	T _{OPR}	-40~+85	°C
Storage Temperature Range	T _{STG}	-50~+125	°C

■ RECOMMENDED OPERATING CONDITIONS (V⁺ = 6V, T_a = 25°C)

PARAMETER	SYMBOL	RATINGS	MIN.	MAX.	UNIT
Operating Voltage	V ⁺		3.6	32	V
Feed Back Resistor	R _{NF}		100	—	kΩ
Oscillator Timing Capacitor	C _T		220	22000	pF
Oscillator Timing Resistor	R _T		10	100	kΩ
Oscillate	f _{OSC}		5	350	kHz

■ ELECTRICAL CHARACTERISTICS

(V⁺ = 6V, R_T = 33kΩ, C_T = 1000pF, T_a = 25°C)

REFERENCE VOLTAGE BLOCK

PARAMETER	SYMBOL	RATINGS	MIN.	TYP.	MAX.	UNIT
Output Voltage	V _{REF}	I _{OR} = 1mA	2.45	2.50	2.55	V
Line Regulation	L _{LINE}	V ⁺ = 3.6~32V, I _{OR} = 1mA	—	6.8	20.7	mV
Load Regulation	L _{LOAD}	I _{OR} = 0.1~5.0mA	—	5	30	mV

OSCILLATOR BLOCK

PARAMETER	SYMBOL	RATINGS	MIN.	TYP.	MAX.	UNIT
Oscillate	f _{OSC}	C _T = 1000pF, R _T = 33kΩ	85	105	125	kHz
Oscillate Fluctuations1 (Line Fluctuations)	f _{dv}	V ⁺ = 3.6~32V	—	1	—	%
Oscillate Fluctuations2 (Temp Fluctuations)	f _{dt}	T _a = -40~+85°C	—	5	—	%

■ ELECTRICAL CHARACTERISTICS

($V^+ = 6V$, $R_T = 33k\Omega$, $C_T = 1000pF$, $T_a = 25^\circ C$)

ERROR AMPLIFIER BLOCK

PARAMETER	SYMBOL	RATINGS	MIN.	TYP.	MAX.	UNIT
Reference Voltage	V_B		0.51	0.52	0.53	V
Input Bias Current	I_B		—	5	100	nA
Open Loop Gain	A_V		—	90	—	dB
Gain Band width Product	G_B		—	0.6	—	MHz
Maximum Output Voltage (F.B Pin)	V_{OM+}	$R_{NF}=100k\Omega$	$V_{REF}-0.2$	—	—	V
	V_{OM-}	$R_{NF}=100k\Omega$	—	—	200	mV
Output Source Current (F.B Pin)	I_{OM+}	$V_{OM}=1V$	40	85	200	μA

PWM COMPARATE BLOCK

PARAMETER	SYMBOL	RATINGS	MIN.	TYP.	MAX.	UNIT
Input Bias Voltage (F.B Pin)	V_{THO}	duty·cycle=0%	—	0.55	0.65	V
Input Threshold Voltage (F.B Pin)	V_{TH50}	duty·cycle=50%	—	0.87	—	V
Maximum Duty Cycle	αM	F.B Pin=1.2V	55	64	85	%

SOFT START CIRCUIT BLOCK

PARAMETER	SYMBOL	RATINGS	MIN.	TYP.	MAX.	UNIT
Input Bias Current (CS Pin)	I_{BCS}		—	250	650	nA
Input Threshold Voltage (CS Pin)	V_{THCS0}	duty·cycle=0%	—	0.25	0.35	V
Input Threshold Voltage (CS Pin)	V_{THCS50}	duty·cycle=50%	—	0.52	—	V

SHORT CIRCUIT PROTECTION

PARAMETER	SYMBOL	RATINGS	MIN.	TYP.	MAX.	UNIT
Input Threshold Voltage (F.B Pin)	V_{THPC}		1.20	1.50	1.80	V
Charge Current (CS Pin)	I_{CHG}	CS Pin=0V, F.B Pin=2V	10	30	50	μA
Latch mode Threshold Voltage (CS Pin)	V_{THLA}		1.20	1.50	1.80	V

UNDER VOLTAGE LOCKOUT

PARAMETER	SYMBOL	RATINGS	MIN.	TYP.	MAX.	UNIT
ON Threshold Voltage	V_{THON}		—	2.70	—	V
OFF Threshold Voltage	V_{THOFF}		—	2.52	—	V
Hysteresis Voltage	V_{HYS}		60	180	—	mV

6

ELECTRICAL CHARACTERISTICS

($V^+ = 6V$, $R_T = 33k\Omega$, $C_T = 1000pF$, $T_a = 25^\circ C$)

OUTPUT

PARAMETER	SYMBOL	RATINGS	MIN.	TYP.	MAX.	UNIT
H-Output Voltage (OUT Pin)	V_{OH}	$R_L = 10k\Omega$	3.50	4.00	—	V
L-Output Voltage (OUT Pin)	V_{OL}	Output Sink Current = 20mA	—	0.25	0.65	V
Output Source Current (OUT Pin)	I_{SOURCE}	OUT Pin = 0V	8	11	—	mA

GENERAL CHARACTERISTIC

PARAMETER	SYMBOL	RATINGS	MIN.	TYP.	MAX.	UNIT
Quiescent Current	I_{CCLA}	Latch	—	1.6	2.2	mA
Average Quiescent Current	I_{CCAV}	$R_L = \infty$, duty cycle = 50%	—	3.5	4.8	mA

APPLICATION



■ TYPICAL CHARACTERISTICS

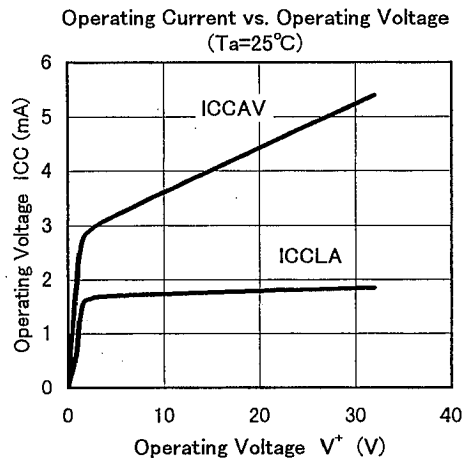
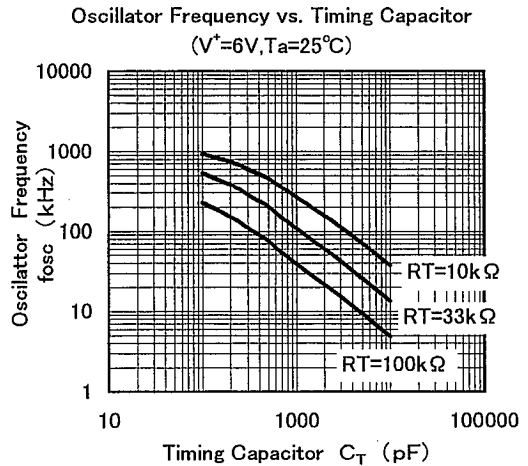

TYPICAL CHARACTERISTICS

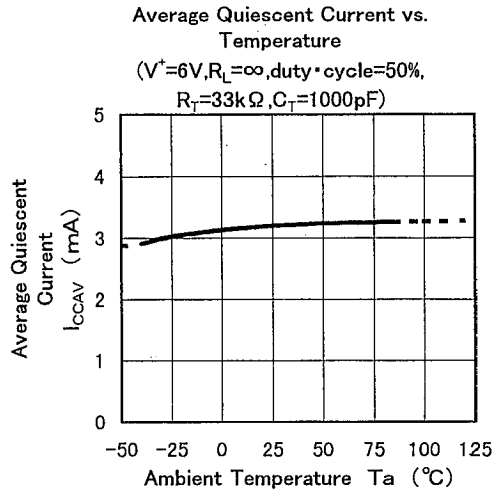
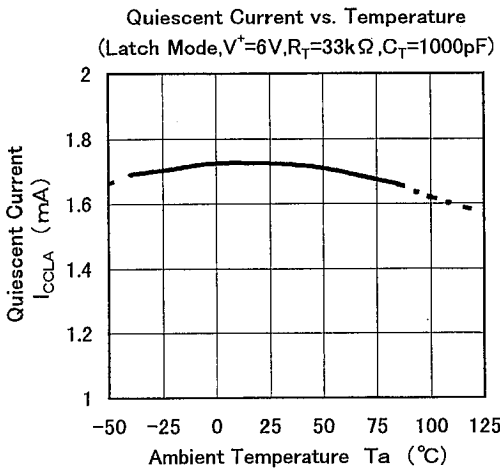
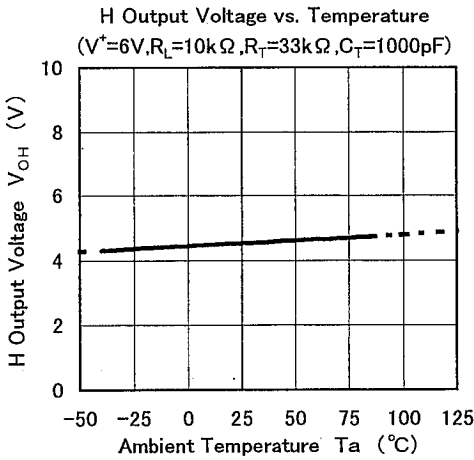
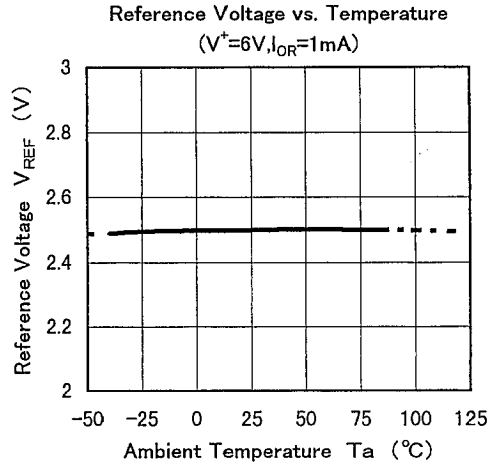
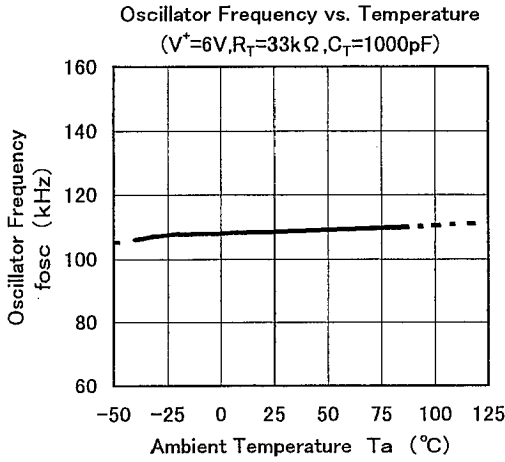

■ TYPICAL CHARACTERISTICS



MEMO

[CAUTION]

The specifications on this databook are only given for information, without any guarantee as regards either mistakes or omissions. The application circuits in this databook are described only to show representative usages of the product and not intended for the guarantee or permission of any right including the industrial rights.



Компания «ЭлектроПласт» предлагает заключение долгосрочных отношений при поставках импортных электронных компонентов на взаимовыгодных условиях!

Наши преимущества:

- Оперативные поставки широкого спектра электронных компонентов отечественного и импортного производства напрямую от производителей и с крупнейших мировых складов;
- Поставка более 17-ти миллионов наименований электронных компонентов;
- Поставка сложных, дефицитных, либо снятых с производства позиций;
- Оперативные сроки поставки под заказ (от 5 рабочих дней);
- Экспресс доставка в любую точку России;
- Техническая поддержка проекта, помощь в подборе аналогов, поставка прототипов;
- Система менеджмента качества сертифицирована по Международному стандарту ISO 9001;
- Лицензия ФСБ на осуществление работ с использованием сведений, составляющих государственную тайну;
- Поставка специализированных компонентов (Xilinx, Altera, Analog Devices, Intersil, Interpoint, Microsemi, Aeroflex, Peregrine, Syfer, Eurofarad, Texas Instrument, Miteq, Cobham, E2V, MA-COM, Hittite, Mini-Circuits, General Dynamics и др.);

Помимо этого, одним из направлений компании «ЭлектроПласт» является направление «Источники питания». Мы предлагаем Вам помощь Конструкторского отдела:

- Подбор оптимального решения, техническое обоснование при выборе компонента;
- Подбор аналогов;
- Консультации по применению компонента;
- Поставка образцов и прототипов;
- Техническая поддержка проекта;
- Защита от снятия компонента с производства.



Как с нами связаться

Телефон: 8 (812) 309 58 32 (многоканальный)

Факс: 8 (812) 320-02-42

Электронная почта: org@eplast1.ru

Адрес: 198099, г. Санкт-Петербург, ул. Калинина, дом 2, корпус 4, литера А.