

XW2R Series Connector-Terminal Block Conversion Units

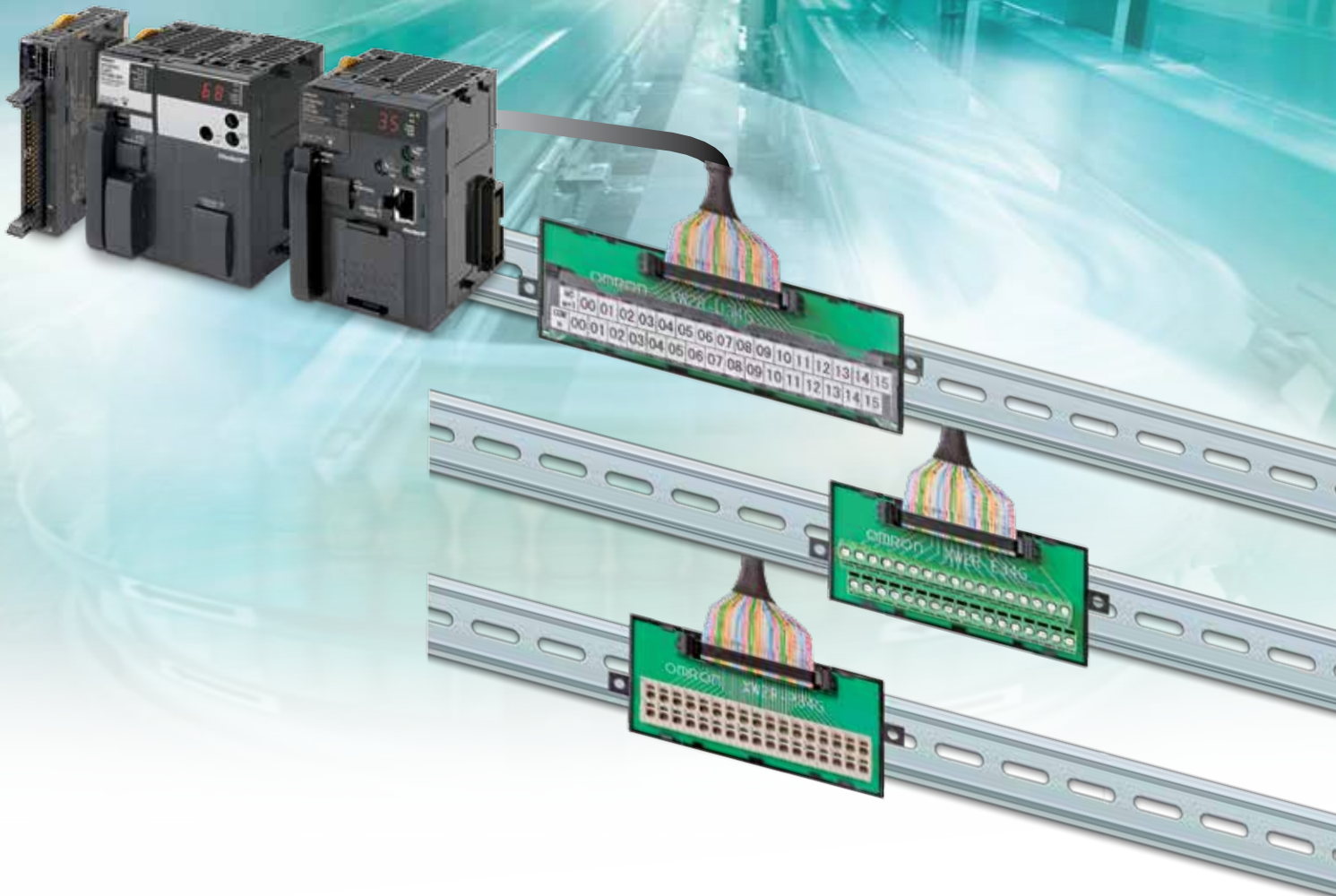

» Simple connection to controllers

» **Slim design**

» Variety of models for various controller types

- Specialized wiring pattern for OMRON and Mitsubishi PLCs
- Minimized size with required number of poles
- Wide variation of poles

General-purpose devices

Wide variation of poles

M3 Screw

XW2R-J□□□□-T□



Clamp

XW2R-E□□□□-T□

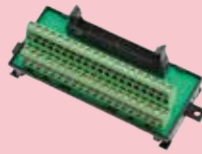

Spring Clamp

XW2R-P□□□□-T□



To page 13 for details on models for general-purpose devices

To page 4 for details on models for OMRON PLCs

To page 9 for details on models for Mitsubishi PLCs

All Models

- Spring Clamp terminals simplify wiring and make the terminal blocks even easier to use. (In comparison to the OMRON XW2F.)
- The terminal arrangement enables smoother wiring work.
- Mount to DIN Rail or with screws.
- Common design that can also be customized.

Connecting Spring Clamp Terminals

Using Ferrules

- How to insert wire

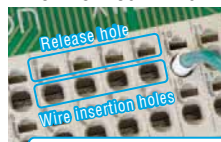

Insert wire into the terminal block.

- How to release wire



Insert the screwdriver into the release hole and pull out the ferrule.

Using Stripped Wires





- Inserting and Removing Wires



To insert a wire, insert a screwdriver into the release hole and then insert the stripped wire. To remove a wire, insert a screwdriver into the release hole and then pull out the stripped wire.

New Series XW2R

Product Lineup

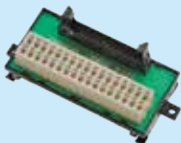
Type		 PLCs 		
Features		Specialized wiring pattern for PLC	Minimized size with required number of poles	
Terminal Type		M3 Screw	Clamp	Spring Clamp
Model	For OMRON PLC	XW2R-J34G-C□	XW2R-E34G-C□	XW2R-P34G-C□
	For Mitsubishi PLC	XW2R-J34G-M□	XW2R-E34G-M□	XW2R-P34G-M□
Appearance				

Smart Features

PLC Connecting type

- Wiring patterns that are specifically designed for PLCs reduce the work required to check signal layout.
- Terminal block signal labels give the PLC addresses.

General-purpose devices	<table border="1"> <tr><td>B1</td><td>B2</td><td>B3</td><td>B4</td><td>B5</td><td>B7</td><td>B8</td><td>B9</td><td>B10</td><td>B11</td><td>B12</td><td>B13</td><td>B14</td><td>B15</td></tr> <tr><td>A1</td><td>A2</td><td>A3</td><td>A4</td><td>A5</td><td>A6</td><td>A7</td><td>A8</td><td>A9</td><td>A10</td><td>A11</td><td>A12</td><td>A13</td><td>A14</td><td>A15</td></tr> </table>	B1	B2	B3	B4	B5	B7	B8	B9	B10	B11	B12	B13	B14	B15	A1	A2	A3	A4	A5	A6	A7	A8	A9	A10	A11	A12	A13	A14	A15																																			
B1	B2	B3	B4	B5	B7	B8	B9	B10	B11	B12	B13	B14	B15																																																				
A1	A2	A3	A4	A5	A6	A7	A8	A9	A10	A11	A12	A13	A14	A15																																																			
For PLCs from OMRON	<table border="1"> <tr><td>INC</td><td>0</td><td>1</td><td>2</td><td>3</td><td>4</td><td>5</td><td>6</td><td>7</td><td>8</td><td>9</td><td>10</td><td>11</td><td>12</td><td>13</td><td>14</td><td>15</td></tr> <tr><td>COM</td><td>0</td><td>1</td><td>2</td><td>3</td><td>4</td><td>5</td><td>6</td><td>7</td><td>8</td><td>9</td><td>10</td><td>11</td><td>12</td><td>13</td><td>14</td><td>15</td></tr> </table>	INC	0	1	2	3	4	5	6	7	8	9	10	11	12	13	14	15	COM	0	1	2	3	4	5	6	7	8	9	10	11	12	13	14	15																														
INC	0	1	2	3	4	5	6	7	8	9	10	11	12	13	14	15																																																	
COM	0	1	2	3	4	5	6	7	8	9	10	11	12	13	14	15																																																	
For PLCs from Mitsubishi	<table border="1"> <tr><td>1</td><td>0</td><td>1</td><td>1</td><td>2</td><td>1</td><td>3</td><td>1</td><td>4</td><td>1</td><td>5</td><td>1</td><td>6</td><td>1</td><td>7</td><td>1</td><td>8</td><td>1</td><td>9</td><td>1</td><td>A</td><td>1</td><td>B</td><td>1</td><td>C</td><td>1</td><td>D</td><td>1</td><td>E</td><td>1</td><td>F</td><td>COM</td></tr> <tr><td>0</td><td>0</td><td>1</td><td>0</td><td>2</td><td>0</td><td>3</td><td>0</td><td>4</td><td>0</td><td>5</td><td>0</td><td>6</td><td>0</td><td>7</td><td>0</td><td>8</td><td>0</td><td>9</td><td>0</td><td>A</td><td>0</td><td>B</td><td>0</td><td>C</td><td>0</td><td>D</td><td>0</td><td>E</td><td>0</td><td>F</td><td>NC</td></tr> </table>	1	0	1	1	2	1	3	1	4	1	5	1	6	1	7	1	8	1	9	1	A	1	B	1	C	1	D	1	E	1	F	COM	0	0	1	0	2	0	3	0	4	0	5	0	6	0	7	0	8	0	9	0	A	0	B	0	C	0	D	0	E	0	F	NC
1	0	1	1	2	1	3	1	4	1	5	1	6	1	7	1	8	1	9	1	A	1	B	1	C	1	D	1	E	1	F	COM																																		
0	0	1	0	2	0	3	0	4	0	5	0	6	0	7	0	8	0	9	0	A	0	B	0	C	0	D	0	E	0	F	NC																																		

General-purpose devices

- More model variations are scheduled for future development, such as models with FCN, MR, or MDR connectors in addition to the current models with MIL connectors.

Connection Examples

■ 32-point Input Unit or Output Unit

CJ1W-ID231 32-point

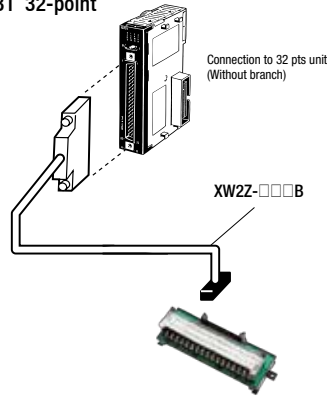

■ 64-point Input Unit or Output Unit

CJ1W-ID261 64-point

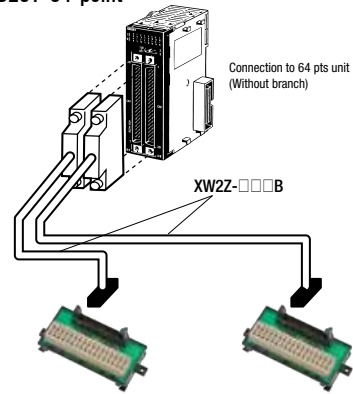

■ 64-point Output Unit

CJ1W-MD563 IN 32 Points, OUT 32 Points

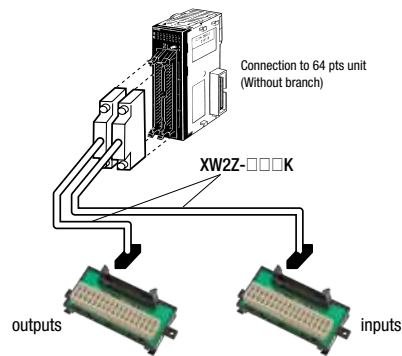

Model List

XW2R - □ 34G - □ □

Wiring method	
J	M3 Screw
E	Clamp
P	Spring Clamp

Mounted Connector type	
G	MIL (XG4A)

PLC type	
C1	Refer to the following table for details.
C2	
C3	
C4	

Models for OMRON PLCs

PLC Type	I/O	I/O Points	I/O Unit Model	Connecting cables
C1	Input	32	CJ1W-ID231	XW2Z-□□□B 32-point Unit: 1 Cable 64-point Unit: 2 Cables
			CS1W-ID231	
			C200H-ID216	
			C200H-ID218	
			CQM1-ID112	
			CQM1-ID213	
			CQM1-ID214	
			CJ1W-ID261	
	CS1W-ID261			
	C200H-ID217	64	C200H-ID219	
C200H-ID111				
C500-ID114	32	C500-ID219		
CJ1W-MD261 (inputs)				
I/O	32	CS1W-MD261 (inputs)		
		CS1W-MD262 (inputs)		
I/O	32	CS1W-MD561 (inputs)		
		CJ1W-ID232		
C2	Input	32	CJ1W-ID233	XW2Z-□□□K 32-point Unit: 1 Cable 64-point Unit: 2 Cables
			64	
I/O	32	CJ1W-MD263 (inputs)		
		CJ1W-MD563 (inputs)		
C3	Output	32	CJ1W-OD231	XW2Z-□□□B 32-point Unit: 1 Cable 64-point Unit: 2 Cables
			CS1W-OD231	
			CS1W-OD232	
			C200H-OD218	
			CQM1-OD213	
			CJ1W-OD261	
			CS1W-OD261	
			CS1W-OD262	
	64	C200H-OD219		
	C500-OD213			
	I/O	32	CJ1W-MD261 (outputs)	
			CS1W-MD261 (outputs)	
			CS1W-MD262 (outputs)	
			CS1W-MD561 (outputs)	
CJ1W-OD232				
CJ1W-OD233				
Output	32	CJ1W-OD234	XW2Z-□□□K 32-point Unit: 1 Cable 64-point Unit: 2 Cables	
		64		CJ1W-OD262
I/O	32	CJ1W-OD263		
		CJ1W-MD263 (outputs)		
I/O	32	CJ1W-MD563 (outputs)		

*Connection is not possible to all OMRON PLC Units.

*□□□ is replaced by the cable length.

*There is one common for each 32 points.

*Refer to page 16-17 for information on Connecting Cables.

Models for Connection to OMRON PLCs

Clamp

Appearance	I/O Points (number of poles)	Model	Dimension A(mm)	Dimension B(mm)
	32 (34)	XW2R-E34G-C1	98.5	108
	32 (34)	XW2R-E34G-C2	98.5	108
	32 (34)	XW2R-E34G-C3	98.5	108
	32 (34)	XW2R-E34G-C4	98.5	108

Ratings and Specifications

Rated current	0.5A/signal, 4A/common
Rated voltage	24VDC
Insulation resistance	100MΩ min.(at 500VDC)
Dielectric strength	500VAC for 1 min (leakage current: 1 mA max.)
Ambient operating temperature	0 to 55°C
Applicable wires	Applicable wire sizes AWG 22 to 16 (rod terminals) AWG 26 to 16 (twisted or solid wires)
	Stripped length 7 mm

Details on Crimp Terminals

Applicable crimp terminals		Applicable wires
Rod	TC-05 Dia. = 1	AWG22 to AWG18 (0.30 to 0.75 mm ²)
	TC-1.25S Dia. = 1.5	AWG22 to AWG16 (0.30 to 1.25 mm ²)
Blade	BT1.25-9-1 BT1.25-10-1 W = 2.2	AWG22 to AWG16 (0.30 to 1.25 mm ²)

Note: Round rod and blade crimp terminals are made by Nichifu.

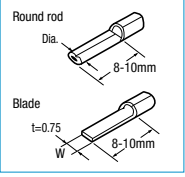

Dimensions

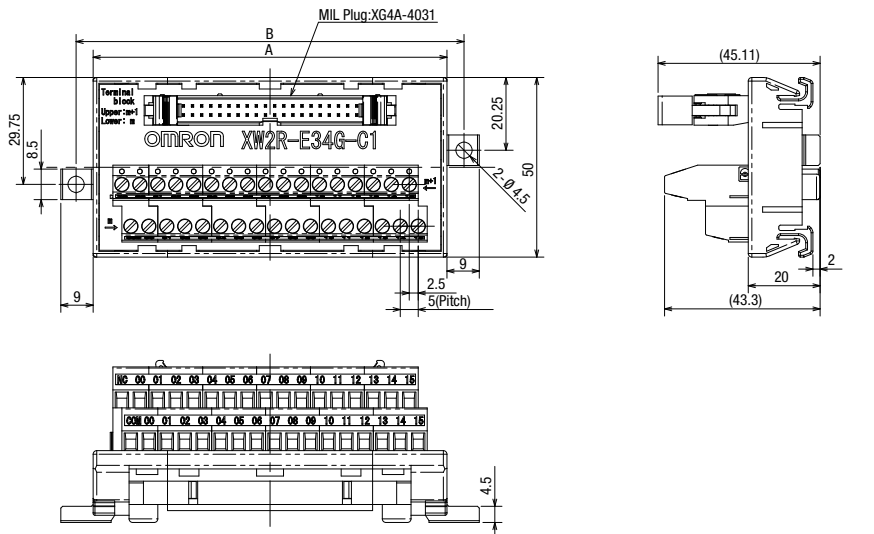

Wiring Diagram

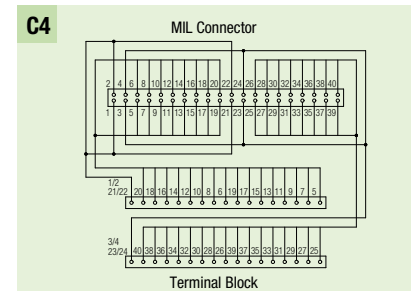
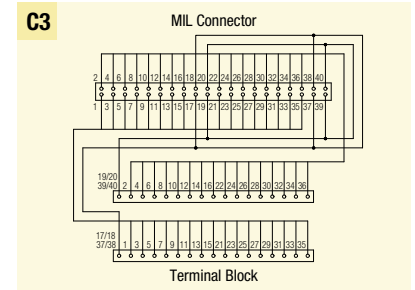
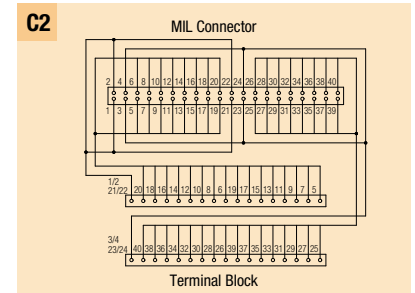
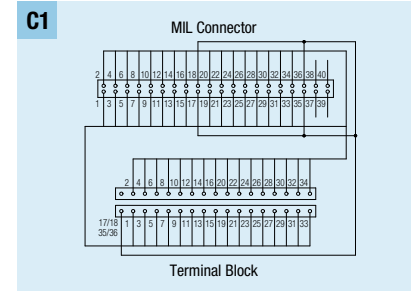

Label Contents

For C1 and C2

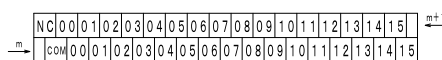

For C3 and C4

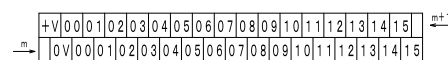

Models for Connection to OMRON PLCs

M3 Screw

Appearance	I/O Points (number of poles)	Model	Dimension A(mm)	Dimension B(mm)
	32 (34)	XW2R-J34G-C1	130.7	140.2
	32 (34)	XW2R-J34G-C2	130.7	140.2
	32 (34)	XW2R-J34G-C3	130.7	140.2
	32 (34)	XW2R-J34G-C4	130.7	140.2

Ratings and Specifications

Rated current	0.5A/signal, 4A/common
Rated voltage	24VDC
Insulation resistance	100MΩ min.(at 500VDC)
Dielectric strength	500VAC for 1 min (leakage current: 1 mA max.)
Ambient operating temperature	0 to 55°C
Applicable wires	Applicable wire sizes
	Stripped length

AWG 22 to 16 (round or forked crimp terminals)
AWG 26 to 16 (twisted or solid wires)
9 mm

Details on Crimp Terminals

- **Wiring Terminal Blocks**
Use crimp terminals on terminal blocks with M3 screws.
- **Terminal Screw Tightening Torque**
Use a tightening torque of 0.5 N·m when connecting wires or crimp terminals to the terminal block.

Applicable crimp terminals	Applicable wires
Round crimp terminals	1.25-3 AWG 22 to 16(0.30 to 1.25 mm ²)
Forked crimp terminals	1.25Y-3 AWG 22 to 16(0.30 to 1.25 mm ²)

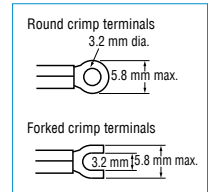

Dimensions

(Unit:mm)

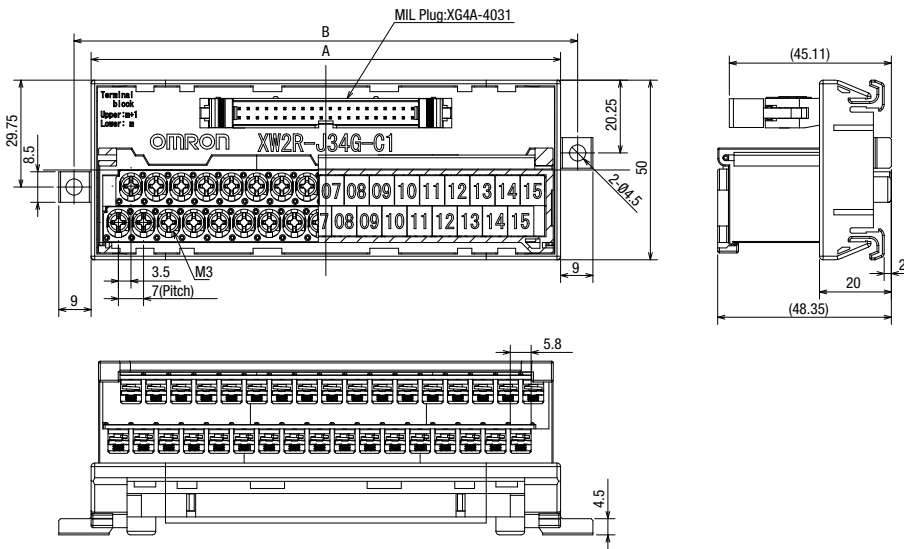

Wiring Diagram

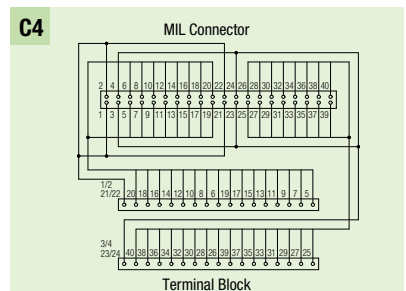
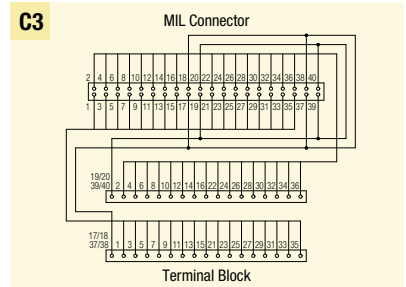
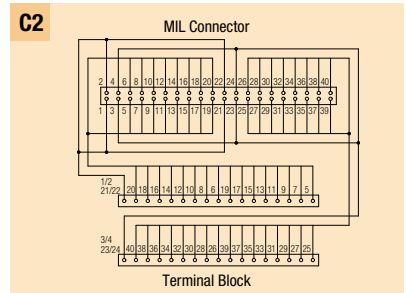
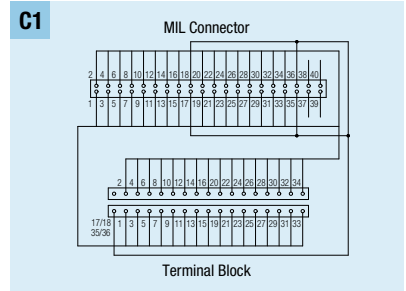

Label Contents

For C1 and C2

NC	00	01	02	03	04	05	06	07	08	09	10	11	12	13	14	15
COM	00	01	02	03	04	05	06	07	08	09	10	11	12	13	14	15

For C3 and C4

+V	00	01	02	03	04	05	06	07	08	09	10	11	12	13	14	15
0V	00	01	02	03	04	05	06	07	08	09	10	11	12	13	14	15

Models for Connection to Mitsubishi PLCs

Model List

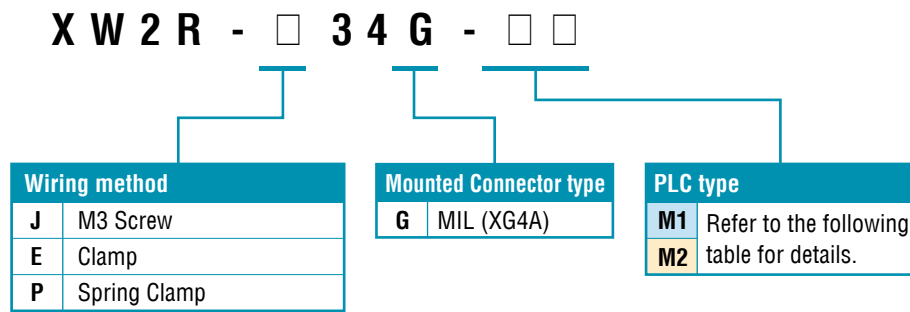

Models for Connection to Mitsubishi PLCs

PLC Type	I/O Points	Mitsubishi PLC Module model	Connecting cables
M1	32	LX41C4	XW2Z-□□□B: 1 cable
		QX41	
		QX41-S1	
		QX41-S2	
		QX71	
		QH42P (input)	
		QX41Y41P (input)	
		A1SX41-S1	
		A1SX41-S2	
		A1SX71	
		A1SH42 (input)	
		A1SH42-S1 (input)	
	64	LX42C4	XW2Z-□□□B: 2 cables
		QX42	
		QX42-S1	
		QX82	
		QX82-S1	
		A1SX42-S1	
		A1SX42-S2	
		A1SX82-S	
M2	32	LY41NT1P	XW2Z-□□□B: 1 cable
		QY41P	
		QY71	
		QH42P (output)	
		QY41Y41P (output)	
		A1SY41-S1	
		A1SY41P	
		A1SY42P	
	A1SY71		
	64	A1SH42 (output)	XW2Z-□□□B: 2 cables
		A1SH42-S1 (output)	
		LY42NT1P	
		QY42P	
		A1SY42	

*□□□ is replaced by the cable length.

*Refer to page 16 for information on Connecting Cables.

Models for Connection to OMRON PLCs

Spring Clamp

Appearance	I/O Points (number of poles)	Model	Dimension A(mm)	Dimension B(mm)
	32 (34)	XW2R-P34G-C1	98.5	108
	32 (34)	XW2R-P34G-C2	98.5	108
	32 (34)	XW2R-P34G-C3	98.5	108
	32 (34)	XW2R-P34G-C4	98.5	108

Ratings and Specifications

Rated current	0.5A/signal, 4A/common	
Rated voltage	24VDC	
Insulation resistance	100M Ω min. (at 500VDC)	
Dielectric strength	500VAC for 1 min	
Ambient operating temperature	0 to 55°C	
Applicable wires	Applicable wire sizes	AWG 24 to 14 (rod terminals), AWG 28 to 14 (twisted or solid wires) (Outer diameter of insulation must be 4 mm max)
	Stripped length	AWG28-16: 8 to 10 mm, AWG14: 9 to 10 mm

Details on Crimp Terminals

● Applicable Ferrules

- Use ferrules of the lengths and thicknesses specified below. If other lengths or thicknesses are used, connection may not be possible or it may not be possible to insert or remove the posts.

• Ferrule Dimensions

Square ferrules	Dimension A (Width)	2.7mm max.	The cross-sectional area after crimping must be 4.8 mm ² or less
	Dimension B (Height)	2 mm max.	
Round ferrules	Dimension C (Diameter)	2 mm dia. max. (after crimping)	

• Special Tools

Model	XW4Z-00B
-------	----------

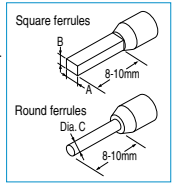

Dimensions

(Unit:mm)

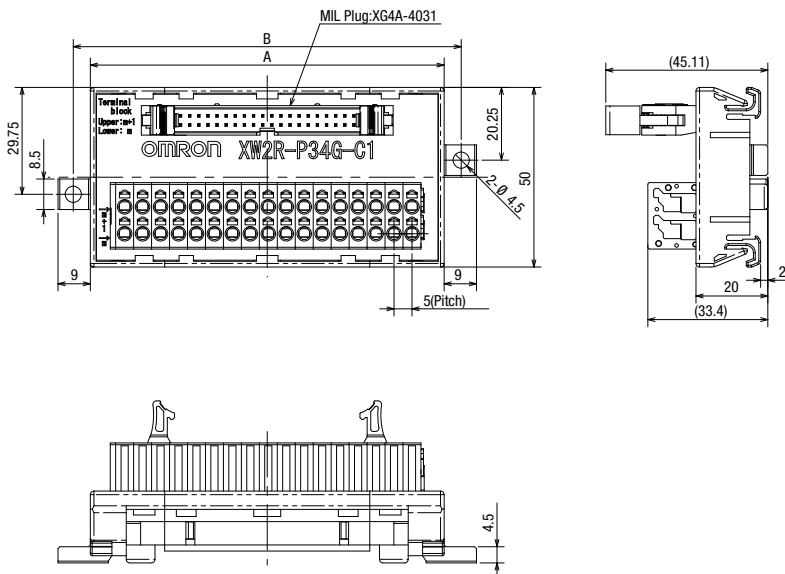

Wiring Diagram

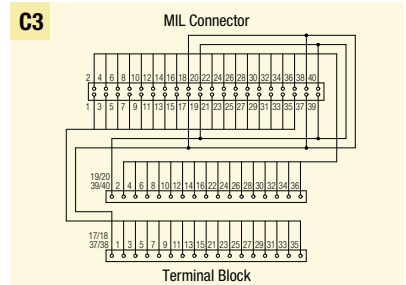
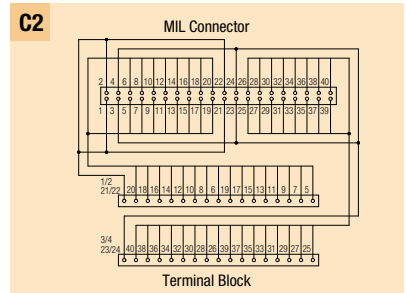
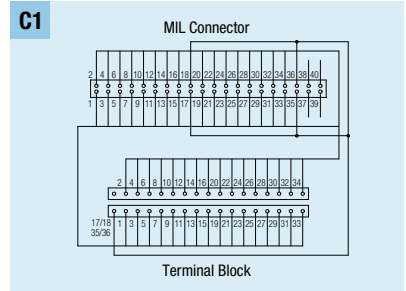

Label Contents

For C1 and C2

m	+	NC	0	0	1	2	3	4	5	6	7	8	9	10	11	12	13	14	15
m	-	COM	0	0	1	2	3	4	5	6	7	8	9	10	11	12	13	14	15

For C3 and C4

m	+	+V	0	0	1	2	3	4	5	6	7	8	9	10	11	12	13	14	15
m	-	0V	0	0	1	2	3	4	5	6	7	8	9	10	11	12	13	14	15

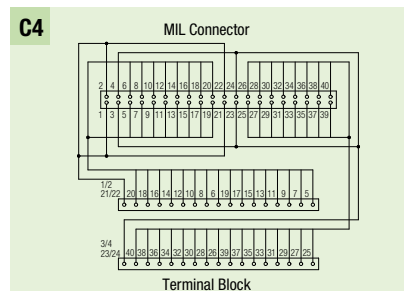

Models for Connection to Mitsubishi PLCs

Clamp

Appearance	I/O Points (number of poles)	Model	Dimension A(mm)	Dimension B(mm)
	32 (34)	XW2R-E34G-M1	98.5	108
	32 (34)	XW2R-E34G-M2	98.5	108

Ratings and Specifications

Rated current	0.5A/signal, 2A/common
Rated voltage	24VDC
Insulation resistance	100MΩ min. (at 500VDC)
Dielectric strength	500VAC for 1 min (leakage current: 1 mA max.)
Ambient operating temperature	0 to 55°C
Applicable wires	Applicable wire sizes
	AWG 22 to 16 (rod terminals) AWG 26 to 16 (twisted or solid wires)
Stripped length	7 mm

Details on Crimp Terminals

Applicable crimp terminals		Applicable wires
Rod	TC-05 Dia. = 1	AWG22 to AWG18 (0.30 to 0.75 mm ²)
	TC-1.25S Dia. = 1.5	AWG22 to AWG16 (0.30 to 1.25 mm ²)
Blade	BT1.25-9-1 BT1.25-10-1	AWG22 to AWG16 (0.30 to 1.25 mm ²)

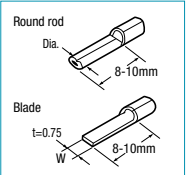

Note: Round rod and blade crimp terminals are made by Nichifu.

Dimensions

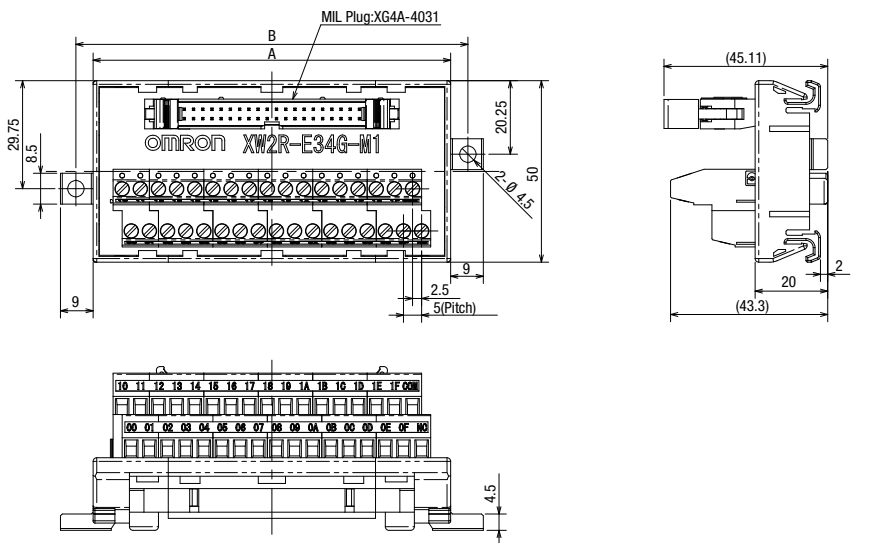

Wiring Diagram

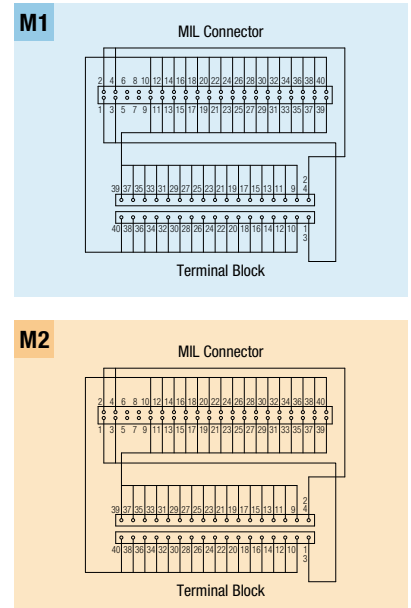

Label Contents

For M1

1	0	1	1	2	1	3	1	4	1	5	1	6	1	7	1	8	1	9	1	A	1	B	1	C	1	D	1	E	1	F	COM	
0	0	0	1	0	2	0	3	0	4	0	5	0	6	0	7	0	8	0	9	0	A	0	B	0	C	0	D	0	E	0	F	NC

For M2

1	0	1	1	2	1	3	1	4	1	5	1	6	1	7	1	8	1	9	1	A	1	B	1	C	1	D	1	E	1	F	V	
0	0	0	1	0	2	0	3	0	4	0	5	0	6	0	7	0	8	0	9	0	A	0	B	0	C	0	D	0	E	0	F	V

Models for Connection to Mitsubishi PLCs

M3 Screw

Appearance	I/O Points (number of poles)	Model	Dimension A(mm)	Dimension B(mm)
	32 (34)	XW2R-J34G-M1	130.7	140.2
	32 (34)	XW2R-J34G-M2	130.7	140.2

Ratings and Specifications

Rated current	0.5A/signal, 2A/common	
Rated voltage	24VDC	
Insulation resistance	100MΩ min. (at 500VDC)	
Dielectric strength	500VAC for 1 min (leakage current: 1 mA max.)	
Ambient operating temperature	0 to 55°C	
Applicable wires	Applicable wire sizes	AWG 22 to 16 (round or forked crimp terminals) AWG 26 to 16 (twisted or solid wires)
	Stripped length	9 mm

Details on Crimp Terminals

- **Wiring Terminal Blocks**
Use crimp terminals on terminal blocks with M3 screws.
- **Terminal Screw Tightening Torque**
Use a tightening torque of 0.5 N-m when connecting wires or crimp terminals to the terminal block.

Applicable crimp terminals	Applicable wires
Round crimp terminals	1.25-3 AWG 22 to 16(0.30 to 1.25 mm ²)
Forked crimp terminals	1.25Y-3 AWG 22 to 16(0.30 to 1.25 mm ²)

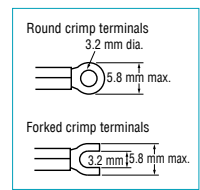

Dimensions

(Unit:mm)

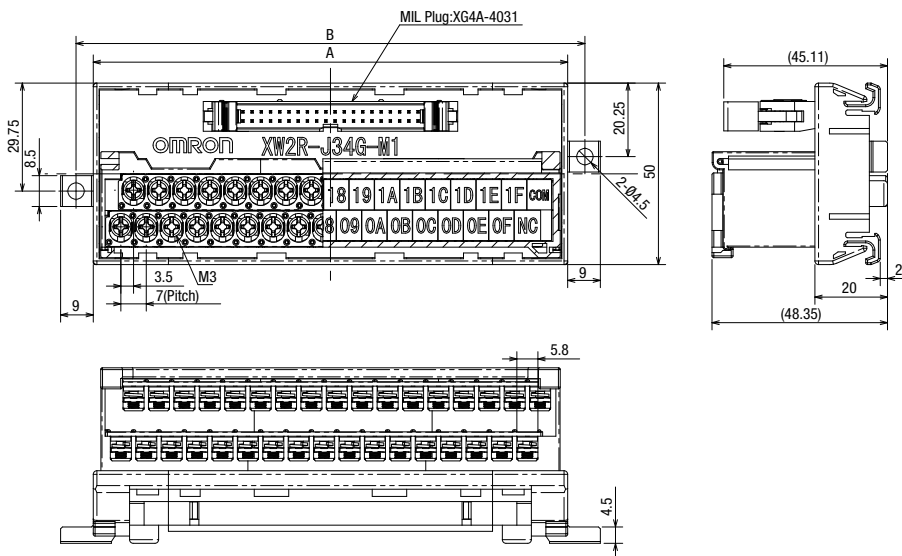

Wiring Diagram

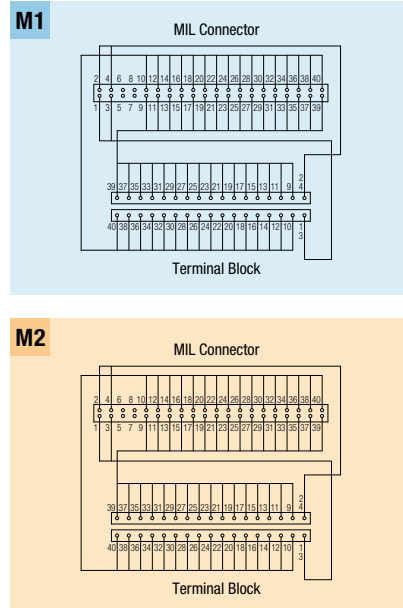

Label Contents

For M1

1	0	1	1	2	3	4	5	6	7	8	9	A	B	C	D	E	F	COM														
0	0	0	1	0	2	0	3	0	4	0	5	0	6	0	7	0	8	0	9	0	A	0	B	0	C	0	D	0	E	0	F	NC

For M2

1	0	1	1	2	3	4	5	6	7	8	9	A	B	C	D	E	F	V															
0	0	0	1	0	2	0	3	0	4	0	5	0	6	0	7	0	8	0	9	0	A	0	B	0	C	0	D	0	E	0	F	0	V

Model List

XW2R - □ □ □ □ □ - T

Wiring method	
J	M3 Screw
E	Clamp
P	Spring Clamp
N	e-CON*

Number of poles	
	20
	34
	40
	50
	60

Mounted Connector type	
G	MIL (XG4A)
C	MIL (XG4C)*
F	FCN*
D	D-sub*
R	MR*
M	MDR*

Plug/Socket	
Blank	Plug (male)
R	Socket (female)*

* Scheduled for release soon.

M3 Screw

Appearance	number of poles	Model	Dimension A(mm)	Dimension B(mm)
	20	XW2R-J20G-T	81.7	91.2
	34	XW2R-J34G-T	130.7	140.2
	40	XW2R-J40G-T	151.7	161.2
	50	XW2R-J50G-T	186.7	196.2
	60	XW2R-J60G-T	221.7	231.2

Ratings and Specifications

Rated current	1A
Rated voltage	125VAC 24VDC
Insulation resistance	100MΩ min.(at 500VDC)
Dielectric strength	500VAC for 1 min (leakage current: 1 mA max.)
Ambient operating temperature	0 to 55°C

*The details on crimp terminals are the same for the XW2R-J34G on page 6.

Label Contents

B1	B2	B3	B4	B5	B6	B7	B8	B9	B10	B11	B12	B13	B14	B15	B16	B17
A1	A2	A3	A4	A5	A6	A7	A8	A9	A10	A11	A12	A13	A14	A15	A16	A17

*The label contents for a Terminal Block with 34 poles are shown.

Dimensions

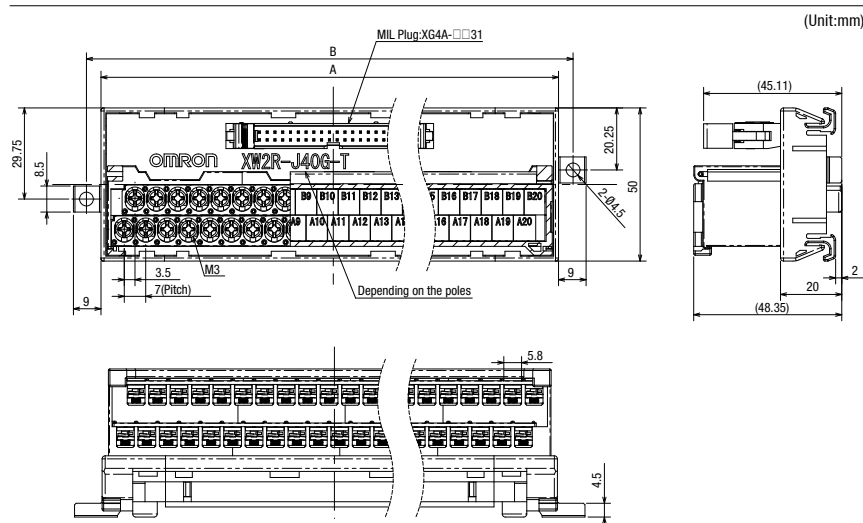

Wiring Diagram

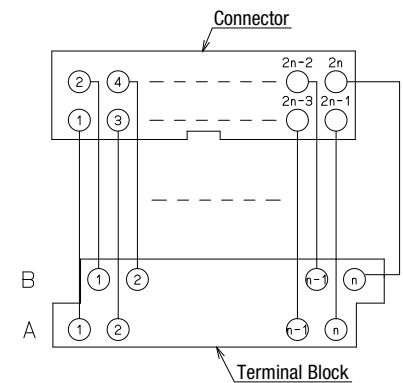

Models for Connection to Mitsubishi PLCs

Spring Clamp

Appearance	I/O Points (number of poles)	Model	Dimension A(mm)	Dimension B(mm)
	32 (34)	XW2R-P34G-M1	98.5	108
	32 (34)	XW2R-P34G-M2	98.5	108

Ratings and Specifications

Rated current	0.5A/signal, 2A/common	
Rated voltage	24VDC	
Insulation resistance	100MΩ min. (at 500VDC)	
Dielectric strength	500VAC for 1 min	
Ambient operating temperature	0 to 55°C	
Applicable wires	Applicable wire sizes	AWG 24 to 14 (rod terminals), AWG 28 to 14 (twisted or solid wires) (Outer diameter of insulation must be 4 mm max)
	Stripped length	AWG28-16: 8 to 10 mm, AWG14: 9 to 10 mm

Details on Crimp Terminals

● Applicable Ferrules

- Use ferrules of the lengths and thicknesses specified below. If other lengths or thicknesses are used, connection may not be possible or it may not be possible to insert or remove the posts.

• Ferrule Dimensions

Square ferrules	Dimension A (Width)	2.7 mm max	The cross-sectional area after crimping must be 4.8 mm ² or less
	Dimension B (Height)	2 mm max.	
Round ferrules	Dimension C (Diameter)	2 mm dia. max. (after crimping)	

• Special Tools

Model	XW4Z-00B
-------	----------

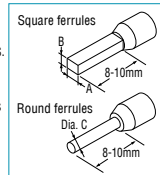

Dimensions

(Unit:mm)

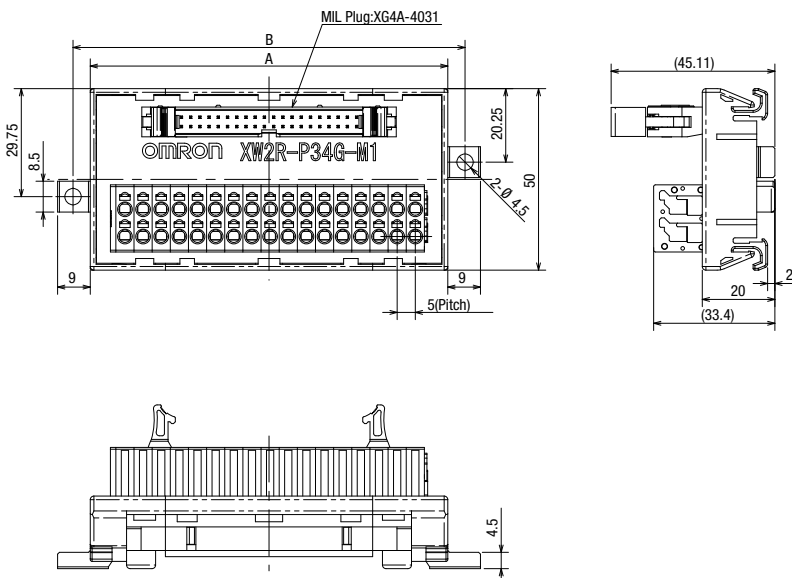

Wiring Diagram

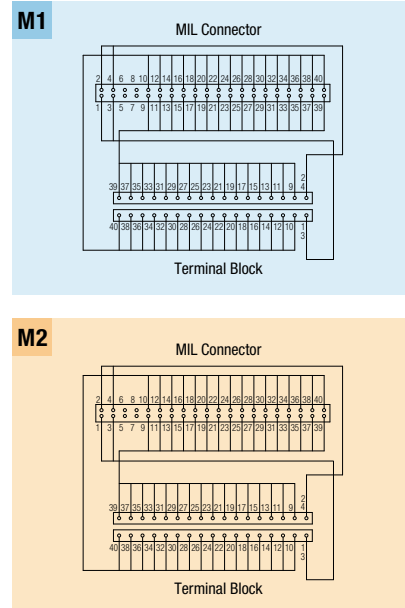

Label Contents

For **M1**

1	0	1	1	1	2	1	3	1	4	1	5	1	6	1	7	1	8	1	9	1	A	1	B	1	C	1	D	1	E	1	F	COM
0	0	0	1	0	2	0	3	0	4	0	5	0	6	0	7	0	8	0	9	0	A	0	B	0	C	0	D	0	E	0	F	NC

For **M2**

1	0	1	1	1	2	1	3	1	4	1	5	1	6	1	7	1	8	1	9	1	A	1	B	1	C	1	D	1	E	1	F	+V
0	0	0	1	0	2	0	3	0	4	0	5	0	6	0	7	0	8	0	9	0	A	0	B	0	C	0	D	0	E	0	F	0V

Spring Clamp

Appearance	number of poles	Model	Dimension A(mm)	Dimension B(mm)
	20	XW2R-P20G-T	64.4	73.9
	34	XW2R-P34G-T	98.5	108
	40	XW2R-P40G-T	113.5	123
	50	XW2R-P50G-T	138.5	148
	60	XW2R-P60G-T	163.5	173

Ratings and Specifications

Rated current	1A	
Rated voltage	125VAC 24VDC	
Insulation resistance	100MΩ min.(at 500VDC)	
Dielectric strength	500VAC for 1 min (leakage current: 1 mA max.)	
Ambient operating temperature	0 to 55°C	
Applicable wires	Applicable wire sizes	AWG 24 to 14 (rod terminals), AWG 28 to 14 (twisted or solid wires)(Outer diameter of insulation must be 4 mm max)
	Stripped length	AWG28-16: 8 to 10 mm, AWG14: 9 to 10 mm

*The details on crimp terminals are the same for the XW2R-P34G on page 8.

Label Contents

B	1	2	3	4	5	6	7	8	9	10	11	12	13	14	15	16	17
A	1	2	3	4	5	6	7	8	9	10	11	12	13	14	15	16	17

*The label contents for a Terminal Block with 34 poles are shown.

Dimensions

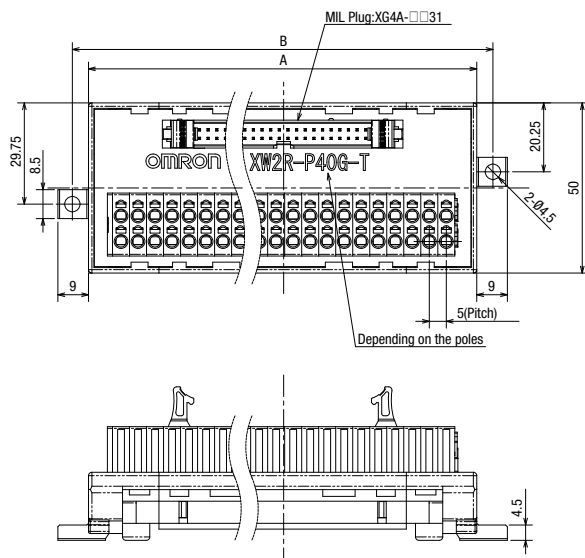

(Unit:mm)

Wiring Diagram

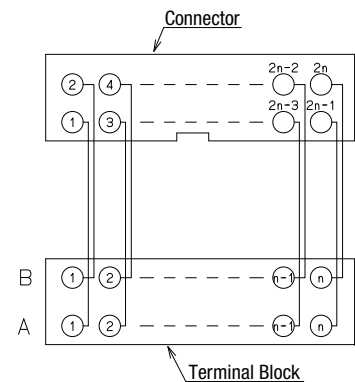

Clamp

Appearance	number of poles	Model	Dimension A(mm)	Dimension B(mm)
	20	XW2R-E20G-T	64.4	73.9
	34	XW2R-E34G-T	98.5	108
	40	XW2R-E40G-T	113.5	123
	50	XW2R-E50G-T	138.5	148
	60	XW2R-E60G-T	163.5	173

Ratings and Specifications

Rated current	1A
Rated voltage	125VAC 24VDC
Insuration resistance	100MΩ min.(at 500VDC)
Dielectric strength	500VAC for 1 min (leakage current: 1 mA max.)
Ambient operating temperature	0 to 55°C

*The details on crimp terminals are the same for the XW2R-E34G on page 7.

Label Contents

B	1	2	3	4	5	6	7	8	9	10	11	12	13	14	15	16	17
A	1	2	3	4	5	6	7	8	9	10	11	12	13	14	15	16	17

*The label contents for a Terminal Block with 34 poles are shown.

Dimensions

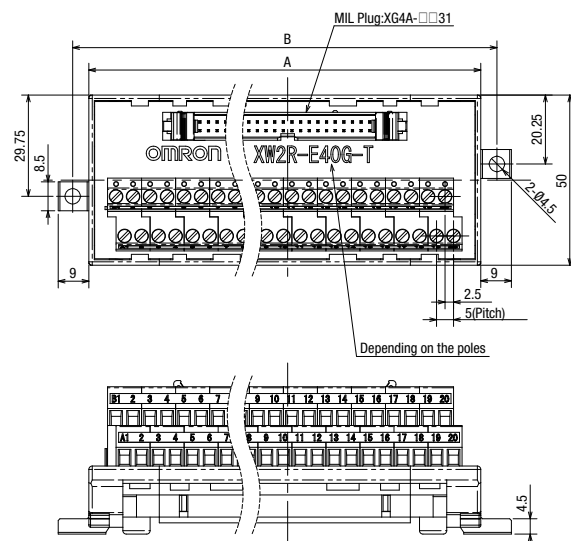

(Unit:mm)

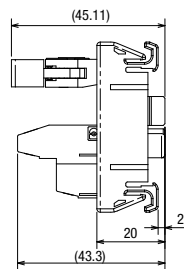

Wiring Diagram

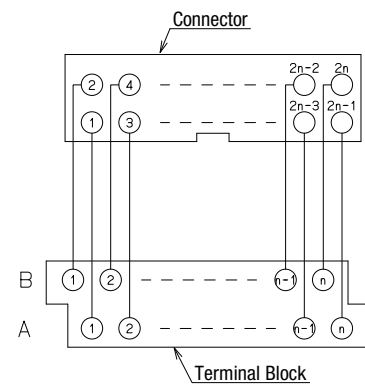

Connecting Cables

XW2Z-□□□D

Connectors: One 40-pin Connector Made by Fujitsu Component, Ltd. to Two 20-pin MIL Connectors

Appearance	Model	Cable length L (m)	
		A	B
	XW2Z-100D	1	0.75
	XW2Z-150D	1.5	1.25
	XW2Z-200D	2	1.75
	XW2Z-300D	3	2.75
	XW2Z-500D	5	4.75
	XW2Z-010D	10	9.75
	XW2Z-15MD	15	14.75
	XW2Z-20MD	20	19.75

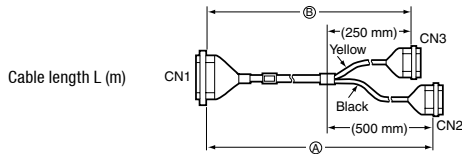

Wiring Diagram

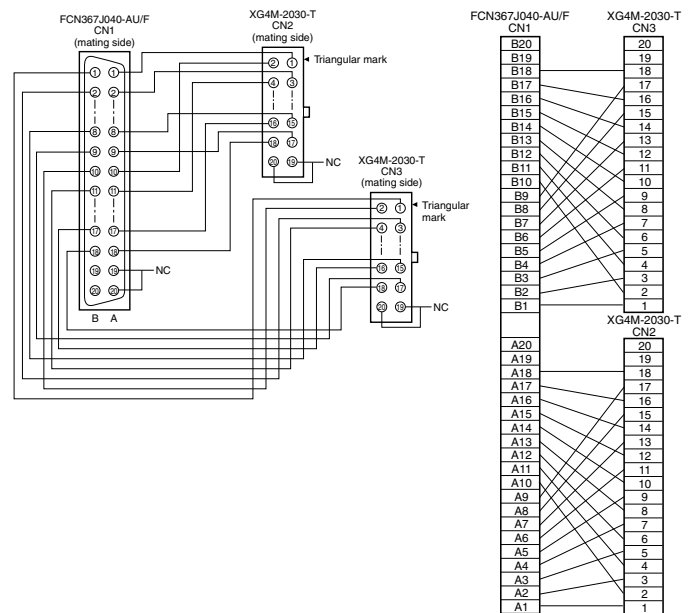

XW2Z-□□□F

Connectors: One 20-pin MIL Connector to 20 Loose Wires with Crimp Terminals Attached

Appearance	Model	Cable length L (m)
	XW2Z-100F	1
	XW2Z-150F	1.5
	XW2Z-200F	2
	XW2Z-300F	3
	XW2Z-500F	5
	XW2Z-010F	10
	XW2Z-15MF	15
	XW2Z-20MF	20

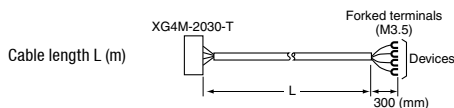

Wiring Diagram

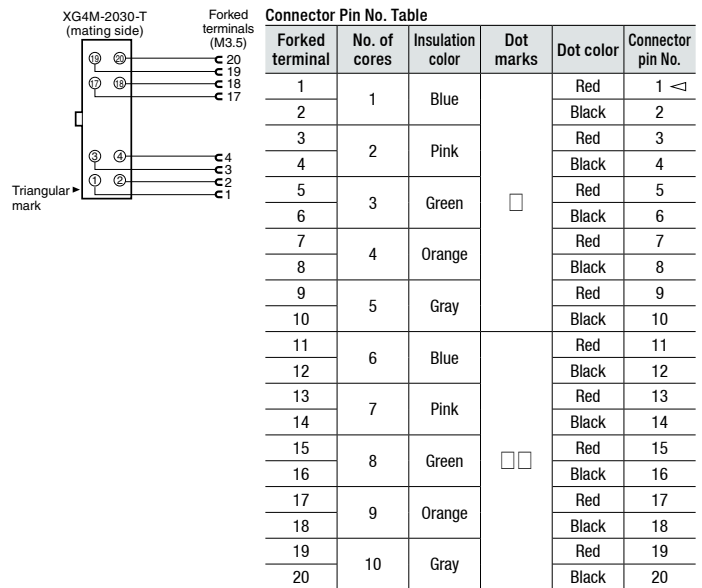

XW2Z-□□□K

Connectors: One 40-pin MIL Connector to One 40-pin MIL Connector

Appearance	Model	Cable length L (m)
	XW2Z-C25K	0.25
	XW2Z-C50K	0.5
	XW2Z-100K	1
	XW2Z-150K	1.5
	XW2Z-200K	2
	XW2Z-300K	3
	XW2Z-500K	5
	XW2Z-010K	10

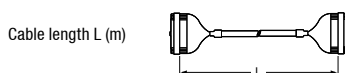

Wiring Diagram

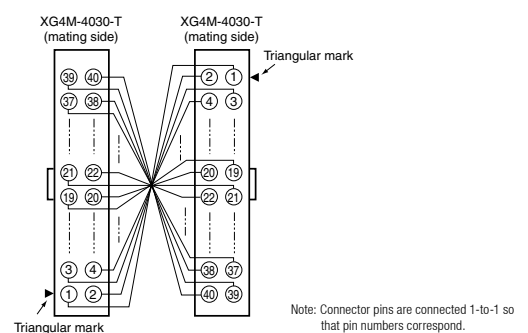

XW2Z

Appearance



Ratings and Specifications

Rated current	1A
Rated voltage	125 VAC 24 VDC
Contact resistance	20 mΩ max. (at 20 mV, 100 mA max.) *1
Insulation resistance	100 MΩ min. (at 500 VDC)
Dielectric strength	500 VAC for 1 min (leakage current: 1 mA max.) *2
Ambient operating temperature	25 to 80°C

*1. Contact resistance for the Connector. *2. Dielectric strength for the Connector.

Materials and Finish

Item	Part name	Materials and Finish	
Connectors	XG4M-2030 XG4M-4030	Housing	Fiber-glass reinforced PBT resin (UL94V-0)/black
		Cover	
	Contacts	Mating end	Phosphor bronze/nickel base, 0.15-μm gold plating
		Press-fit end	Phosphor bronze/nickel base, 2.0-μm tin plating
	XG4T-2004/4004	Strain Relief	Fiber-glass reinforced PBT resin (UL94V-0)/black
	FCN-367J024-AU/F * FCN-367J040-AU/F	Housing	Polyester resin (UL94V-0)/black
Contacts		Mating end	Copper alloy/gold plated
		Press-fit end	Copper alloy/tin plated
Connecting screw	Steel/nickel plated		
Cable	UL2464 Interface Cable	AWG28	
Crimp terminal	Forked crimp terminal	1.25 YAS 3.5 or the equivalent	

* These housings, contacts, and connecting screws are made by Fujitsu Component, Ltd.

XW2Z-□□□A

Connectors: One 24-pin Connector Made by Fujitsu Component, Ltd. to One 20-pin MIL Connector

Appearance	Model	Cable length L (m)
	XW2Z-050A	0.5
	XW2Z-100A	1
	XW2Z-150A	1.5
	XW2Z-200A	2
	XW2Z-300A	3
	XW2Z-500A	5
	XW2Z-700A	7
	XW2Z-010A	10
	XW2Z-15MA	15
	XW2Z-20MA	20

Wiring Diagram

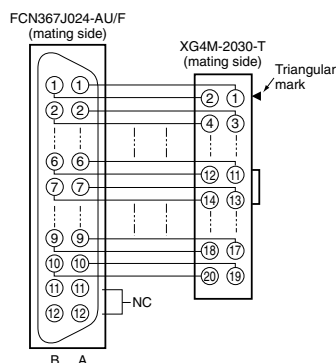

Cable length L (m)

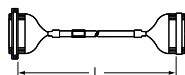

XW2Z-□□□B

Connectors: One 40-pin Connector Made by Fujitsu Component, Ltd. to One 40-pin MIL Connector

Appearance	Model	Cable length L (m)
	XW2Z-050B	0.5
	XW2Z-100B	1
	XW2Z-150B	1.5
	XW2Z-200B	2
	XW2Z-300B	3
	XW2Z-500B	5
	XW2Z-700B	7
	XW2Z-010B	10
	XW2Z-15MB	15
	XW2Z-20MB	20

Wiring Diagram

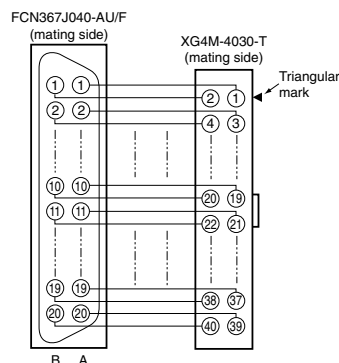

Cable length L (m)

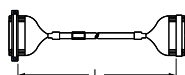

Safety Precautions

Precautions for Correct Use

● Wiring Precautions

- Do not perform wiring work, remove connectors, or connect connectors while power is being supplied.
Electric shock or damage to the device may result.
- Double-check all wiring before turning ON the power supply.
- After wiring, route the cable so that force is not applied directly to the connections.

● Wires for Terminal Blocks

- Do not damage the cores when stripping the insulation from them.
- Always twist stranded wires together before connecting them.
- Do not presolder wires. It may not be possible to connect them or remove them.

Connecting Cables

XW2Z-□□□L

Connectors: One 40-pin Connector Made by Fujitsu Component, Ltd. to Two 20-pin MIL Connectors

Appearance	Model	Cable length L (m)	
		A	B
	XW2Z-100L	1	0.75
	XW2Z-150L	1.5	1.25
	XW2Z-200L	2	1.75
	XW2Z-300L	3	2.75
	XW2Z-500L	5	4.75
	XW2Z-010L	10	9.75
	XW2Z-15ML	15	14.75
	XW2Z-20ML	20	19.75

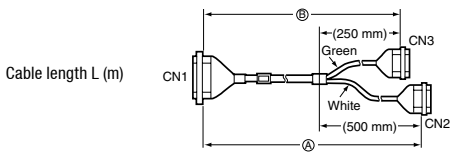

Wiring Diagram

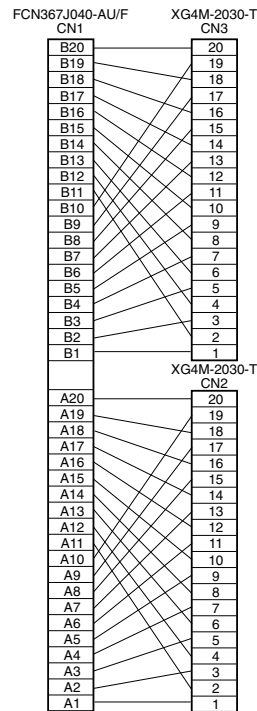

XW2Z-□□□N

Connectors: One 40-pin MIL Connector to Two 20-pin MIL Connectors

Appearance	Model	Cable length L (m)	
		A	B
	XW2Z-100N	1	0.75
	XW2Z-150N	1.5	1.25
	XW2Z-200N	2	1.75
	XW2Z-300N	3	2.75
	XW2Z-500N	5	4.75
	XW2Z-010N	10	9.75
	XW2Z-15MN	15	14.75
	XW2Z-20MN	20	19.75

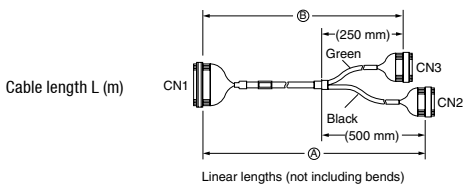

Wiring Diagram

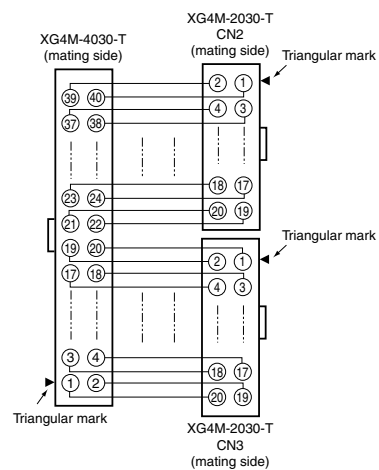

XW2Z-□□□X

Connectors: One 20-pin MIL Connector to One 20-pin MIL Connector

Appearance	Model	Cable length L (m)
	XW2Z-100X	1
	XW2Z-200X	2
	XW2Z-300X	3
	XW2Z-500X	5
	XW2Z-010X	10

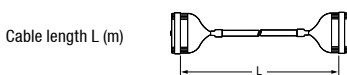

Wiring Diagram

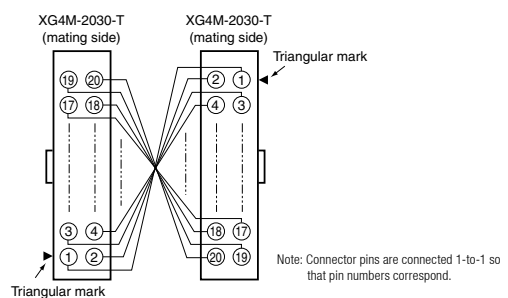

OMRON AUTOMATION AND SAFETY • THE AMERICAS HEADQUARTERS • Schaumburg, IL USA • 847.843.7900 • 800.556.6766 • www.omron247.com

OMRON CANADA, INC. • HEAD OFFICE

Toronto, ON, Canada • 416.286.6465 • 866.986.6766 • www.omron247.com

OMRON ELECTRONICS DE MEXICO • HEAD OFFICE

México DF • 52.55.59.01.43.00 • 001.800.556.6766 • mela@omron.com

OMRON ELECTRONICS DE MEXICO • SALES OFFICE

Apodaca, N.L. • 52.81.11.56.99.20 • 001.800.556.6766 • mela@omron.com

OMRON ELETRÔNICA DO BRASIL LTDA • HEAD OFFICE

São Paulo, SP, Brasil • 55.11.2101.6300 • www.omron.com.br

OMRON ARGENTINA • SALES OFFICE

Cono Sur • 54.11.4783.5300

OMRON CHILE • SALES OFFICE

Santiago • 56.9.9917.3920

OTHER OMRON LATIN AMERICA SALES

54.11.4783.5300

OMRON EUROPE B.V. • Wegalaan 67-69, NL-2132 JD, Hoofddorp, The Netherlands. • Tel: +31 (0) 23 568 13 00 • Fax: +31 (0) 23 568 13 88 • www.industrial.omron.eu

Authorized Distributor:

Automation Control Systems

- Machine Automation Controllers (MAC) • Programmable Controllers (PLC)
- Operator interfaces (HMI) • Distributed I/O • Software

Drives & Motion Controls

- Servo & AC Drives • Motion Controllers & Encoders

Temperature & Process Controllers

- Single and Multi-loop Controllers

Sensors & Vision

- Proximity Sensors • Photoelectric Sensors • Fiber-Optic Sensors
- Amplified Photomicrosensors • Measurement Sensors
- Ultrasonic Sensors • Vision Sensors • RFID/Code Readers

Industrial Components

- Relays • Pushbuttons & Indicators • Limit and Basic Switches • Timers
- Counters • Metering Devices • Power Supplies

Safety

- Laser Scanners • Safety Mats • Edges and Bumpers
- Programmable Safety Controllers • Light Curtains • Safety Relays
- Safety Interlock Switches

Mouser Electronics

Authorized Distributor

Click to View Pricing, Inventory, Delivery & Lifecycle Information:

Omron:

[XW2R-E34G-C3](#) [XW2R-J34G-C4](#) [XW2R-E40G-T](#) [XW2R-E20G-T](#) [XW2R-J34G-C3](#) [XW2R-J40G-T](#) [XW2R-E34G-C4](#)
[XW2R-J20G-T](#) [XW2R-P34G-C1](#) [XW2R-J34G-C2](#) [XW2R-P34G-C3](#) [XW2R-P34G-C4](#) [XW2R-E34G-C1](#) [XW2R-](#)
[E34G-C2](#) [XW2R-J34G-C1](#) [XW2R-P20G-T](#) [XW2R-P34G-C2](#) [XW2R-P40G-T](#)



Компания «ЭлектроПласт» предлагает заключение долгосрочных отношений при поставках импортных электронных компонентов на взаимовыгодных условиях!

Наши преимущества:

- Оперативные поставки широкого спектра электронных компонентов отечественного и импортного производства напрямую от производителей и с крупнейших мировых складов;
- Поставка более 17-ти миллионов наименований электронных компонентов;
- Поставка сложных, дефицитных, либо снятых с производства позиций;
- Оперативные сроки поставки под заказ (от 5 рабочих дней);
- Экспресс доставка в любую точку России;
- Техническая поддержка проекта, помощь в подборе аналогов, поставка прототипов;
- Система менеджмента качества сертифицирована по Международному стандарту ISO 9001;
- Лицензия ФСБ на осуществление работ с использованием сведений, составляющих государственную тайну;
- Поставка специализированных компонентов (Xilinx, Altera, Analog Devices, Intersil, Interpoint, Microsemi, Aeroflex, Peregrine, Syfer, Eurofarad, Texas Instrument, Miteq, Cobham, E2V, MA-COM, Hittite, Mini-Circuits, General Dynamics и др.);

Помимо этого, одним из направлений компании «ЭлектроПласт» является направление «Источники питания». Мы предлагаем Вам помощь Конструкторского отдела:

- Подбор оптимального решения, техническое обоснование при выборе компонента;
- Подбор аналогов;
- Консультации по применению компонента;
- Поставка образцов и прототипов;
- Техническая поддержка проекта;
- Защита от снятия компонента с производства.



Как с нами связаться

Телефон: 8 (812) 309 58 32 (многоканальный)

Факс: 8 (812) 320-02-42

Электронная почта: org@eplast1.ru

Адрес: 198099, г. Санкт-Петербург, ул. Калинина, дом 2, корпус 4, литера А.