

# STRAIGHT PLUG FEMALE

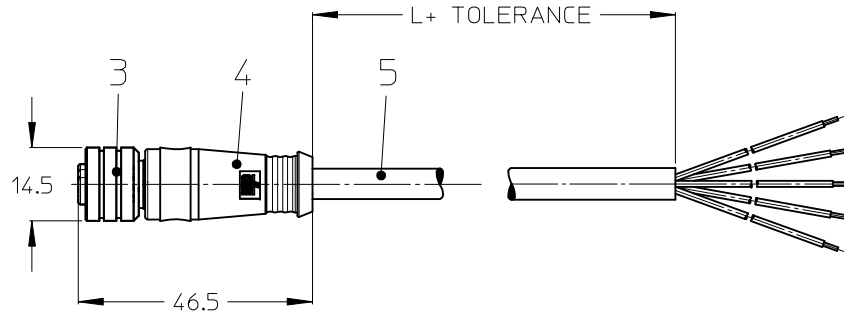
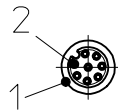

### NOTES:

TEMPERATURE RANGE	SEE TABLE ON PAGE 2
CONTACT CURRENT RATING	3-5 POLES 4A 8 POLES 2A
VOLTAGE RATING	3-4 POLES 250V 5 POLES 60V 8 POLES 30V
PROTECTION CLASS	IP 67

### CABLE TOLERANCES

≤ 1m	+20/-10mm
1m - 5m	± 25mm
5m - 10m	± 30mm
> 10m	± 30mm
> 20m	± 50mm

3 WIRE	4 WIRE	5 WIRE	8 WIRE
PIN # WIRE	PIN # WIRE	PIN # WIRE	PIN # WIRE
1 BROWN 2 - 3 BLUE 4 BLACK 5 -	1 BROWN 2 WHITE 3 BLUE 4 BLACK 5 -	1 BROWN 2 WHITE 3 BLUE 4 BLACK 5 GREY	1 WHITE 2 BROWN 3 GREEN 4 YELLOW 5 GREY 6 PINK 7 BLUE 8 RED
REQUIRED TO IEC 60947-5-2			REQUIRED TO DIN 47100

5	CABLE	SEE TABLE (PAGE 2)	---
4	OVERMOULDING	TPU	BLACK
3	MALE COUPLING NUT	BRASS	NI PLATED
2	PIN CONTACT	BRASS	GOLD PLATED
1	INSERT	PA	BLACK
ITEM	PART	MATERIAL	FINISH

<b>ENTER DESCRIPTION</b> EC NO: IPG2014-0812 DRWN:PMERUNKA 2012/04/23 CHKD:APOHL 2013/11/15 APPR:APOHL 2013/11/18	QUALITY SYMBOLS = 0 = 0	GENERAL TOLERANCES (UNLESS SPECIFIED)		DIMENSION STYLE <b>MM ONLY</b>		SCALE <b>1:1</b>	DESIGN UNITS METRIC	THIRD ANGLE PROJECTION	
			mm	INCH	DRAWN BY PMERUNKA	DATE 2012/04/23	TITLE CSE M12 XP AC FE STR XM SE UNSH		
		4 PLACES	± ---	± ---	CHECKED BY APOHL	DATE 2013/11/15			
		3 PLACES	± ---	± ---	APPROVED BY APOHL	DATE 2013/11/18			
2 PLACES	± 0.05	± ---	MATERIAL NO. SEE TABLE		DOCUMENT NO. SD-120065-050		SHEET NO. 1 OF 5		
1 PLACE	± 0.10	± ---	DRAFT WHERE APPLICABLE MUST REMAIN WITHIN DIMENSIONS						
0 PLACE	± ---	± ---	SIZE A3 THIS DRAWING CONTAINS INFORMATION THAT IS PROPRIETARY TO MOLEX INCORPORATED AND SHOULD NOT BE USED WITHOUT WRITTEN PERMISSION						

**NUMERICAL CODE** (Available parts see table page 3 ff others on request.)

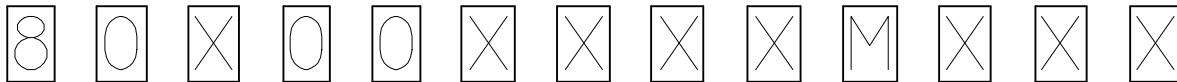

80 = M12x1  
single ended

poles:  
3 = 3 poles  
4 = 4 poles  
5 = 5 poles  
8 = 8 poles

header:  
000 = plug female straight  
001 = plug female 90° right  
006 = plug male straight  
007 = plug male 90° right

Cable:  
E02 = 0,25mm<sup>2</sup>, PVC black  
E03 = 0,34mm<sup>2</sup>, PVC black  
H08 = 0,25mm<sup>2</sup>, PUR black LS0H  
H09 = 0,34mm<sup>2</sup>, PUR black LS0H  
I03 = 0,34mm<sup>2</sup>, PVC grey  
K05 = 0,34mm<sup>2</sup>, TPE yellow  
P02 = 0,25mm<sup>2</sup>, PUR/PVC black  
P03 = 0,34mm<sup>2</sup>, PUR/PVC black  
P82 = 0,34mm<sup>2</sup>, PUR black irradiated  
B30 = 0,34mm<sup>2</sup>, TPE black

M = meter

length:  
Example  
020 = 2 m

**Special Types:**

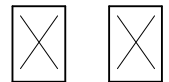



G = Brad in black  
H = Sid with ID tag  
1 = Stainless Steel  
7 = Teflon coat

y = yellow overmoulding  
empty for black

CABLE TYPE	WIRE GAUGE	CABLE JACKET	UL	CSA	static	flexing	drag chain tested	other
E02	0.25mm <sup>2</sup>	PVC black	STYLE 2464	I/II A/B 80°/300V	-30°C to +80°C 5xD	-5°C to +80°C 9xD	---	---
E03	0.34mm <sup>2</sup>	PVC black	STYLE 2464	I/II A/B 80°/300V	-30°C to +80°C 5xD	-5°C to +80°C 9xD	---	---
H08	0.25mm <sup>2</sup>	PUR black LS0H	AWM STYLE 21198/10493	APPROVED	-50°C to +80°C 5xD	-25°C to +80°C 10xD	2000000 cycles	---
H09	0.34mm <sup>2</sup>	PUR black LS0H	AWM STYLE 21198/10493	APPROVED	-50°C to +80°C 5xD	-25°C to +80°C 10xD	drag chain 60°C	---
I03	0.34mm <sup>2</sup>	PVC grey	---	---	-30°C to +70°C	-5°C to +70°C	---	---
K05	0.34mm <sup>2</sup>	TPE yellow	ITC E195601 or PLTC	AWM I/II A/B FT4 LL54185	---	---	---	CSA-US: ITC LL54185-02
P02	0.25mm <sup>2</sup>	PUR/PVC black	not applicable	not applicable	-30°C to +80°C 7xD	-5°C to +80°C 15xD	---	---
P03	0.34mm <sup>2</sup>	PUR/PVC black	not applicable	not applicable	-30°C to +80°C 7xD	-5°C to +80°C 15xD	---	---
P82	0.34mm <sup>2</sup>	irrad. PUR orange	---	---	-50°C to +105°C 5xD	-40°C to +105°C 7,5xD	---	---
B30	0.34mm <sup>2</sup>	PUR black	STYLE 21215	Yes	-40°C to +90°C 5xD	-25°C to +80°C 7,5xD	---	---

ENTER DESCRIPTION EC NO: IPG2014-0812 DRWN: PMERUNKA 2012/04/23 CHKD: APOHL 2013/11/15 APPR: APOHL 2013/11/18	QUALITY SYMBOLS ▽=0 ◻=0	GENERAL TOLERANCES (UNLESS SPECIFIED)		DIMENSION STYLE MM ONLY		SCALE 1:1	DESIGN UNITS METRIC	THIRD ANGLE PROJECTION			
		4 PLACES ± --- ± --- 3 PLACES ± --- ± --- 2 PLACES ± 0.05 ± --- 1 PLACE ± 0.10 ± --- 0 PLACE ± --- ± ---		DRAWN BY PMERUNKA DATE 2012/04/23 CHECKED BY APOHL DATE 2013/11/15 APPROVED BY APOHL DATE 2013/11/18		TITLE CSE M12 XP AC FE STR XM SE UNSH					
		ANGULAR ± .5 °		MATERIAL NO.		DOCUMENT NO.		SHEET NO.			
		DRAFT WHERE APPLICABLE MUST REMAIN WITHIN DIMENSIONS		SEE TABLE		SD-120065-050		2 OF 5			

	10	9	8	7	6	5	4	3	2	1
F	120060107	803000E03M003	1200651110	803000K05M050	120060014	804000E03M020	1200658641	804000H09M040	1200064161	804000I20M100
	120060027	803000E03M006	1200651111	803000K05M060	1200600427	804000E03M0201	1200658179	804000H09M050	1200658543	804000I20M150
	1200658562	803000E03M010	1200651112	803000K05M100	120061337	804000E03M0205	1200664434	804000H09M050G	1200652022	804000K03M006
	1200600001	803000E03M020	120061765	803000P03M002	1200658894	804000E03M020G	1200658008	804000H09M050H	1200651287	804000K03M010
	1200658219	803000E03M0201	120062098	803000P03M006	120062866	804000E03M020H	1200658190	804000H09M100	1200651288	804000K03M020
	1200658887	803000E03M020H	120060152	803000P03M010	120060428	804000E03M030	1200664435	804000H09M100G	1200650886	804000K03M0208
	120061958	803000E03M021	120060004	803000P03M020	120063443	804000E03M030H	1200658009	804000H09M100H	1200651290	804000K03M030
E	120060113	803000E03M030	1200010768	803000P03M020X	1200658570	804000E03M040	1200658191	804000H09M150	1200651291	804000K03M040
	1200658563	803000E03M040	120060153	803000P03M030	1200606015	804000E03M050	1200658218	804000H09M150G	1200651292	804000K03M0402
	120060002	803000E03M050	120065012	803000P03M030G	120060429	804000E03M0501	1200658880	804000H09M200	1200650887	804000K03M0408
	120060115	803000E03M0501	120064093	803000P03M032	120060430	804000E03M0505	120065006	804000H09M250G	1200651293	804000K03M050
	120060116	803000E03M0505	1200658610	803000P03M040	1200658288	804000E03M050G	1200061680	804000H69M050	1200651295	804000K03M0502
	1200658889	803000E03M050H	120060005	803000P03M050	120062130	804000E03M050H	1200658242	804000H69M300	1200650888	804000K03M0508
	1200602071	803000E03M060	1200651769	803000P03M050G	1200658782	804000E03M060	1200062141	804000I03M003	1200651296	804000K03M060
	1200600003	803000E03M100	120063687	803000P03M050GQ	1200658896	804000E03M075	1200658599	804000I03M010	1200651297	804000K03M0602
	1200658350	803000E03M1001	1200651770	803000P03M050GQ	1200606016	804000E03M100	1200658701	804000I03M010G	1200651298	804000K03M070
	120060117	803000E03M1005	120063415	803000P03M0707	120063407	804000E03M1001	120060452	804000I03M020	1200651299	804000K03M080
	120060119	803000E03M150	1200606006	803000P03M100	1200658270	804000E03M1005	1200658702	804000I03M020G	1200651300	804000K03M100
D	120060121	803000E03M200	120063673	803000P03M1001	1200658882	804000E03M100H	120060454	804000I03M030	1200650889	804000K03M1008
	120060124	803000E03M2505	120062811	803000P03M100H	120064422	804000E03M120	1200658703	804000I03M030G	1200651302	804000K03M120
	1200658636	803000H09M010	120060157	803000P03M150	120060431	804000E03M150	1200658600	804000I03M040	1200651303	804000K03M150
	1200658637	803000H09M015	120060158	803000P03M200	1200658475	804000E03M1501	1200658704	804000I03M040G	1200651304	804000K03M200
	1200658175	803000H09M020	120062772	803000P03M250	120062264	804000E03M1505	1200606017	804000I03M050	1200651120	804000K05M010
	1200658638	803000H09M030	120062754	803000P82M004	120060432	804000E03M200	1200658705	804000I03M050G	1200651121	804000K05M020
	1200658639	803000H09M040	120062454	803000P82M0067	120063647	804000E03M2001	120063205	804000I03M060	1200651122	804000K05M030
	1200658176	803000H09M050	120064073	803000P82M010	120062992	804000E03M200H	120064230	804000I03M080	1200651123	804000K05M040
	1200658177	803000H09M100	120064256	803000P82M020	120061528	804000E03M250	120060033	804000I03M100	1200651124	804000K05M050
C	120062852	803000I03M015	120061240	803000P82M050	120061913	804000E03M300	120061970	804000I03M100A	1200651125	804000K05M060
	120060145	803000I03M020	1200659040	804000E02M050	1200658228	804000E03M3001	1200658706	804000I03M100G	1200651126	804000K05M100
	1200658593	803000I03M040	1200659038	804000E02M100	1200658891	804000H09M003	120061955	804000I03M200A	1200651127	804000K05M200
	1200606030	803000I03M050	1200658266	804000E03C550	1200658640	804000H09M010	120061956	804000I03M300A	1200651306	804000K05M300
	120060148	803000I03M100	1200658983	804000E03M002	1200658550	804000H09M015	120061957	804000I03M400A	1200658609	804000P02M020
	120061559	803000I20M100	120063224	804000E03M003	1200658178	804000H09M020	120063562	804000I04M030G	1200658927	804000P02M050
	1200651108	803000K05M020	120060032	804000E03M005	1200658907	804000H09M020H	120064164	804000I20M020	120063402	804000P03M003
	1200651109	803000K05M040	120060426	804000E03M010	1200658473	804000H09M030	1200658221	804000I20M050	1200010061	804000P03M003W

<b>ENTER DESCRIPTION</b> EC NO: IPG2014-0812 DRWN: PMERUNKA 2012/04/23 CHKD: APOHL 2013/11/15 APPR: APOHL 2013/11/18	<b>QUALITY SYMBOLS</b>  = 0.05  = 0.1	<b>GENERAL TOLERANCES (UNLESS SPECIFIED)</b>		<b>DIMENSION STYLE</b> <b>MM ONLY</b>		<b>SCALE</b> 1:1	<b>DESIGN UNITS</b> METRIC	 <b>THIRD ANGLE PROJECTION</b>	
		4 PLACES ± --- ± ---	DRAWN BY PMERUNKA DATE 2012/04/23	<b>TITLE</b> CSE M12 XP AC FE STR XM SE UNSH					
		3 PLACES ± --- ± ---	CHECKED BY APOHL DATE 2013/11/15						
		2 PLACES ± 0.05 ± ---	APPROVED BY APOHL DATE 2013/11/18	<b>MATERIAL NO.</b> SEE TABLE				<b>DOCUMENT NO.</b> SD-120065-050	<b>SHEET NO.</b> 3 OF 5
1 PLACE ± 0.10 ± ---	<b>DRAFT WHERE APPLICABLE MUST REMAIN WITHIN DIMENSIONS</b>								
0 PLACE ± --- ± ---	<b>THIS DRAWING CONTAINS INFORMATION THAT IS PROPRIETARY TO MOLEX INCORPORATED AND SHOULD NOT BE USED WITHOUT WRITTEN PERMISSION</b>								

	10	9	8	7	6	5	4	3	2	1
F	1200658321	804000P03M005	1200062853	804000P03M150	1200658928	805000E03M1001	1200651372	805000K03M080	1200658590	808000E02M030
	1200063940	804000P03M0051	1200010070	804000P03M150W	1200655081	805000E03M150	1200651373	805000K03M100	1200658591	808000E02M040
	1200063121	804000P03M0053	1200060461	804000P03M200	1200658081	805000E03M200	1200060646	805000P03M003	1200658224	808000E02M050
	1200010062	804000P03M005W	1200658806	804000P04M003	1200063779	805000E03M300	1200658197	805000P03M010	1200658309	808000E02M0501
	1200061785	804000P03M006	1200063017	804000P04M0083	1200658015	805000E63M020A	1200060647	805000P03M020	1200658278	808000E02M100
	1200063227	804000P03M0063	1200063114	804000P04M0163	1200061936	805000E63M050A	1200065004	805000P03M0201	1200658551	808000E02M1001
	1200010063	804000P03M006W	1200658807	804000P04M020	1200061780	805000E71M100	1200062521	805000P03M030	1200658812	808000E02M150
	1200658064	804000P03M010	1200062364	804000P04M020G	1200658632	805000H09M010	1200658020	805000P03M040	1200658984	808000E02M2501
E	1200658622	804000P03M010G	1200064490	804000P20M020	1200658633	805000H09M015	1200651792	805000P03M050	1200658236	808000E52M020
	1200010064	804000P03M010W	1200062656	804000P20M030	1200658172	805000H09M020	1200658977	805000P03M050G	1200062049	808000E52M050
	1200658545	804000P03M015	1200062657	804000P20M050	1200658634	805000H09M030	1200658990	805000P03M050H	1200658642	808000H08M010
	1200010065	804000P03M015W	1200062604	804000P20M100	1200658635	805000H09M040	1200652154	805000P03M060	1200658643	808000H08M015
	1200060018	804000P03M020	1200062869	804000P20M150	1200658173	805000H09M050	1200060649	805000P03M100	1200658644	808000H08M020
	1200060456	804000P03M0201	1200658282	804000P20M250	1200658174	805000H09M100	1200658991	805000P03M100H	1200658813	808000H08M025
	1200010066	804000P03M020W	1200064072	804000P82M006	1200658780	805000H09M200	1200061431	805000P03M150	1200658645	808000H08M030
	1200010776	804000P03M020X	1200655336	804000P82M0107	1200658605	805000I03M010	1200064292	805000P03M200	1200658646	808000H08M040
	1200060034	804000P03M025	1200064044	804000P82M020	1200658283	805000I03M020	1200064313	805000P03M200G	1200658244	808000H08M050
	1200060457	804000P03M030	1200062254	804000P82M0207	1200060644	805000I03M030	1200063041	805000P12M0033	1200658264	808000H08M100
D	1200658623	804000P03M030G	1200060466	804000P82M030	1200658606	805000I03M040	1200658086	805000P12M020	1200658930	808000H08M150
	1200010067	804000P03M030W	1200655605	804000P82M0307	1200062003	805000I03M050	1200064445	805000P12M023	1200658899	808000H08M250
	1200652143	804000P03M040	1200060035	804000P82M0507	1200063824	805000I03M050G	1200062858	805000P12M100	1200658677	808000I02M010
	1200658630	804000P03M040G	1200060468	804000P82M100	1200060645	805000I03M100	1200063913	805000P20M003	1200658678	808000I02M020
	1200060019	804000P03M050	1200060036	804000P82M1007	1200655025	805000I03M100G	1200659049	805000P20M050	1200658679	808000I02M030
	1200060458	804000P03M0501	1200658902	804000P82M2007	1200658817	805000I26M010	1200063035	805000P20M100	1200658680	808000I02M040
	1200651780	804000P03M050G	1200658502	805000E03M005	1200061727	805000I26M050	1200659042	805000P70M044	1200658681	808000I02M050
	1200651781	804000P03M050GQ	1200658208	805000E03M0061	1200062969	805000I26M100	1200065005	805000P82M020	1200658682	808000I02M100
	1200062347	804000P03M050H	1200063314	805000E03M010	1200658553	805000I26M150	1200060715	805000P82M050	1200658525	808000P02C350
C	1200010068	804000P03M050W	1200060634	805000E03M020	1200658554	805000I26M200	1200658966	805000P82M0507	1200655073	808000P02M003
	1200652144	804000P03M060	1200658503	805000E03M0201	1200658555	805000I26M250	1200658299	805000P82M100	1200651794	808000P02M010
	1200651782	804000P03M100	1200658165	805000E03M030	1200651367	805000K03M020	1200659026	805000P82M1007	1200650951	808000P02M020
	1200064390	804000P03M1001	1200658592	805000E03M040	1200651368	805000K03M030	1200658920	808000E02M005H	1200658022	808000P02M030
	1200658492	804000P03M100G	1200651978	805000E03M050	1200651369	805000K03M040	1200658860	808000E02M0061G	1200650952	808000P02M040
	1200062167	804000P03M100H	1200658210	805000E03M0501	1200651370	805000K03M050	1200658511	808000E02M010	1200650953	808000P02M050
	1200010069	804000P03M100W	1200658331	805000E03M050H	1200652040	805000K03M0508	1200658921	808000E02M010H	1200650954	808000P02M060
	1200064033	804000P03M120	1200060638	805000E03M100	1200651371	805000K03M060	1200658277	808000E02M020	1200651795	808000P02M070

<b>ENTER DESCRIPTION</b> EC NO: IPG2014-0812 DRWN: PMERUNKA 2012/04/23 CHKD: APOHL 2013/11/15 APPR: APOHL 2013/11/18	<b>QUALITY SYMBOLS</b>  	<b>GENERAL TOLERANCES (UNLESS SPECIFIED)</b>		<b>DIMENSION STYLE</b> <b>MM ONLY</b>		<b>SCALE</b> <b>1:1</b>	<b>DESIGN UNITS</b> <b>METRIC</b>	<b>THIRD ANGLE PROJECTION</b>	
		4 PLACES ± --- ± --- 3 PLACES ± --- ± --- 2 PLACES ± 0.05 ± --- 1 PLACE ± 0.10 ± --- 0 PLACE ± --- ± ---	mm INCH ± --- ± --- ± 0.05 ± --- ± 0.10 ± --- ± --- ± ---	DRAWN BY PMERUNKA	DATE 2012/04/23	<b>TITLE</b> <b>CSE M12 XP AC FE STR XM SE UNSH</b>			
		DRAFT WHERE APPLICABLE MUST REMAIN WITHIN DIMENSIONS		CHECKED BY APOHL	DATE 2013/11/15				
				APPROVED BY APOHL	DATE 2013/11/18	MATERIAL NO. <b>SEE TABLE</b>	DOCUMENT NO. <b>SD-120065-050</b>	SHEET NO. <b>4 OF 5</b>	

10 9 8 7 6 5 4 3 2 1

F

E

D

C

B

A

1200650955	808000P02M080
1200650956	808000P02M0801
1200650957	808000P02M100
1200658021	808000P02M150
1200651817	808000P02M200
1200651818	808000P02M250
1200651820	808000P02M300
1200658103	808000P19M005
1200062765	808000P19M020
1200062675	808000P19M030
1200651796	808000P19M040
1200062676	808000P19M050
1200655074	808000P19M060
1200652019	808000P19M100
1200658104	808000P19M150
1200655040	80C000H45M020
1200655041	80C000H45M040
1200655042	80C000H45M050
1200655044	80C000H45M100
1200659119	803000I03M020Y
1200678393	8030P0I03M050Y
1200659054	803000E03M050Y
1200659055	803000E03M100Y
1200659064	803000I03M050Y
1200659073	803000I03M100Y
1200659123	804000P03M100HY
1200678387	8040P0I03M050Y
1200659058	804000E03M050Y
1200659059	804000E03M100Y
1200659060	804000I03M050Y
1200659065	804000I03M100Y
1200659066	804000P82M0507Y
1200659067	804000P82M1007Y
1200659075	804000I03M020Y

1200659076	804000S20M100Y
1200659087	804000P82M0207Y
1200659088	804000P03M050HY
1200698319	804S00P20M050Y
1200659097	804000H09M050Y
1200678365	8040P0E03M100Y
1200659116	805000I26M050Y
1200659082	805000E03M100Y
1200659085	805000I03M050Y
1200659090	805000I26M100Y
1200659092	808000P02M050Y
1200659100	808000E02M050Y
1200659102	808000H08M100Y
1200659103	808000E02M100Y
1200659106	808000E02M150Y
1200659107	808000H08M150Y
1200659214	805000P03M300
1200659224	805006P03M200
1200659225	805006P03M300
1200659230	805007P03M010
1200659231	805007P03M200
1200652247	803000B30M010
1200652248	803000B30M020
1200652249	803000B30M050
1200652250	803000B30M100
1200652251	804000B30M010
1200652252	804000B30M020
1200652253	804000B30M050
1200652254	804000B30M100
1200652255	805000B30M010
1200652256	805000B30M020
1200652257	805000B30M050
1200652258	805000B30M100

ENTER DESCRIPTION EC NO: IPG2014-0812 DRWN:PMERUNKA 2012/04/23 CHKD:APOHL 2013/11/15 APPR:APOHL 2013/11/18	QUALITY SYMBOLS ▽=0 ◻=0	GENERAL TOLERANCES (UNLESS SPECIFIED)		DIMENSION STYLE MM ONLY		SCALE 1:1	DESIGN UNITS METRIC	THIRD ANGLE PROJECTION		
			mm	INCH	DRAWN BY PMERUNKA	DATE 2012/04/23	TITLE CSE M12 XP AC FE STR XM SE UNSH			
		4 PLACES	± ---	± ---	CHECKED BY APOHL	DATE 2013/11/15				
		3 PLACES	± ---	± ---	APPROVED BY APOHL	DATE 2013/11/18	 DOCUMENT NO. SD-120065-050 SHEET NO. 5 OF 5			
2 PLACES	± 0.05	± ---	MATERIAL NO. SEE TABLE							
1 PLACE	± 0.10	± ---	DRAFT WHERE APPLICABLE MUST REMAIN WITHIN DIMENSIONS		THIS DRAWING CONTAINS INFORMATION THAT IS PROPRIETARY TO MOLEX INCORPORATED AND SHOULD NOT BE USED WITHOUT WRITTEN PERMISSION					
0 PLACE	± ---	± ---	ANGULAR ± .5 °							

9 8 7 6 5 4 3 2 1



Компания «ЭлектроПласт» предлагает заключение долгосрочных отношений при поставках импортных электронных компонентов на взаимовыгодных условиях!

Наши преимущества:

- Оперативные поставки широкого спектра электронных компонентов отечественного и импортного производства напрямую от производителей и с крупнейших мировых складов;
- Поставка более 17-ти миллионов наименований электронных компонентов;
- Поставка сложных, дефицитных, либо снятых с производства позиций;
- Оперативные сроки поставки под заказ (от 5 рабочих дней);
- Экспресс доставка в любую точку России;
- Техническая поддержка проекта, помощь в подборе аналогов, поставка прототипов;
- Система менеджмента качества сертифицирована по Международному стандарту ISO 9001;
- Лицензия ФСБ на осуществление работ с использованием сведений, составляющих государственную тайну;
- Поставка специализированных компонентов (Xilinx, Altera, Analog Devices, Intersil, Interpoint, Microsemi, Aeroflex, Peregrine, Syfer, Eurofarad, Texas Instrument, Miteq, Cobham, E2V, MA-COM, Hittite, Mini-Circuits, General Dynamics и др.);

Помимо этого, одним из направлений компании «ЭлектроПласт» является направление «Источники питания». Мы предлагаем Вам помощь Конструкторского отдела:

- Подбор оптимального решения, техническое обоснование при выборе компонента;
- Подбор аналогов;
- Консультации по применению компонента;
- Поставка образцов и прототипов;
- Техническая поддержка проекта;
- Защита от снятия компонента с производства.



#### Как с нами связаться

**Телефон:** 8 (812) 309 58 32 (многоканальный)

**Факс:** 8 (812) 320-02-42

**Электронная почта:** [org@eplast1.ru](mailto:org@eplast1.ru)

**Адрес:** 198099, г. Санкт-Петербург, ул. Калинина, дом 2, корпус 4, литера А.