



Micro Commercial Components



Micro Commercial Components
 20736 Marilla Street Chatsworth
 CA 91311
 Phone: (818) 701-4933
 Fax: (818) 701-4939

MMBT5401

PNP Plastic Encapsulate Transistor

Features

- Halogen free available upon request by adding suffix "-HF"
- Collector Current: $I_{CM}=0.6A$
- Collector-Base Voltage: $V_{(BR)CBO}=160V$
- Operating And Storage Temperatures $-55^{\circ}C$ to $150^{\circ}C$
- Capable of 0.3Watts of Power Dissipation
- Marking: 2L
- Lead Free Finish/RoHS Compliant ("P" Suffix designates RoHS Compliant. See ordering information)
- Epoxy meets UL 94 V-0 flammability rating
- Moisture Sensitivity Level 1

Electrical Characteristics @ 25°C Unless Otherwise Specified

Symbol	Parameter	Min	Max	Units
--------	-----------	-----	-----	-------

OFF CHARACTERISTICS

$V_{(BR)CEO}$	Collector-Emmitter Breakdown Voltage ($I_C=1.0mA$, $I_B=0$)	150	---	Vdc
$V_{(BR)CBO}$	Collector-Base Breakdown Voltage ($I_C=100\mu A$, $I_E=0$)	160	---	Vdc
$V_{(BR)EBO}$	Emmitter-Base Breakdown Voltage ($I_E=10\mu A$, $I_C=0$)	5.0	---	Vdc
I_{CBO}	Collector Cutoff Current ($V_{CB}=120Vdc$, $I_E=0$)	---	0.1	μA
I_{EBO}	Emmitter Cutoff Current ($V_{EB}=4.0Vdc$, $I_C=0$)	---	0.1	μA

ON CHARACTERISTICS

h_{FE-1}	DC Current Gain ($V_{CE}=5.0Vdc$, $I_C=1.0mA$)	80	---	---
h_{FE-2}	DC Current Gain ($V_{CE}=5.0Vdc$, $I_C=10mA$)	100	200	---
h_{FE-3}	DC Current Gain ($V_{CE}=5.0Vdc$, $I_C=50mA$)	50	---	---
$V_{CE(sat)}$	Collector-Emmitter Saturation Voltage ($I_C=50mA$, $I_B=5.0mA$)	---	0.5	Vdc
$V_{BE(sat)}$	Base-Emmitter Saturation Voltage ($I_C=50mA$, $I_B=5.0mA$)	---	1.0	Vdc

SMALL-SIGNAL CHARACTERISTICS

f_T	Current Gain-Bandwidth Product ($I_C=10mA$, $V_{CE}=5.0Vdc$, $f=30MHz$)	100	---	MHz
-------	--	-----	-----	-----

SOT-23

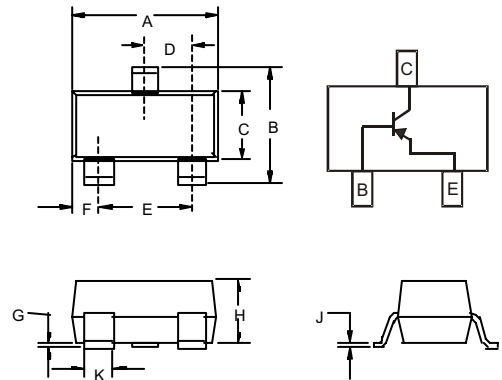

DIM	INCHES		MM		NOTE
	MIN	MAX	MIN	MAX	
A	.110	.120	2.80	3.04	
B	.083	.104	2.10	2.64	
C	.047	.055	1.20	1.40	
D	.035	.041	.89	1.03	
E	.070	.081	1.78	2.05	
F	.018	.024	.45	.60	
G	.0005	.0039	.013	.100	
H	.035	.044	.89	1.12	
J	.003	.007	.085	.180	
K	.015	.020	.37	.51	

Suggested Solder Pad Layout

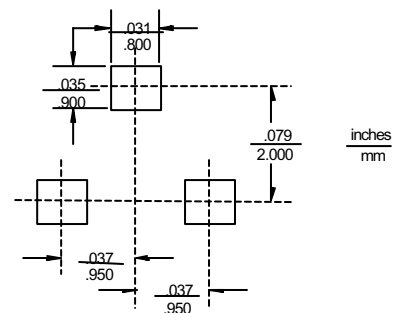

MMBT5401

Static Characteristic

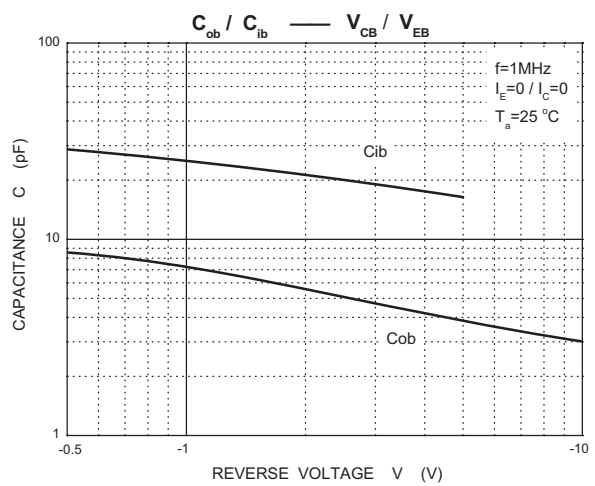
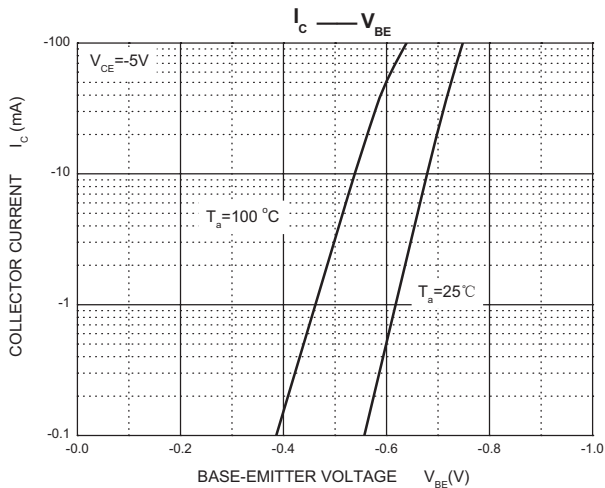
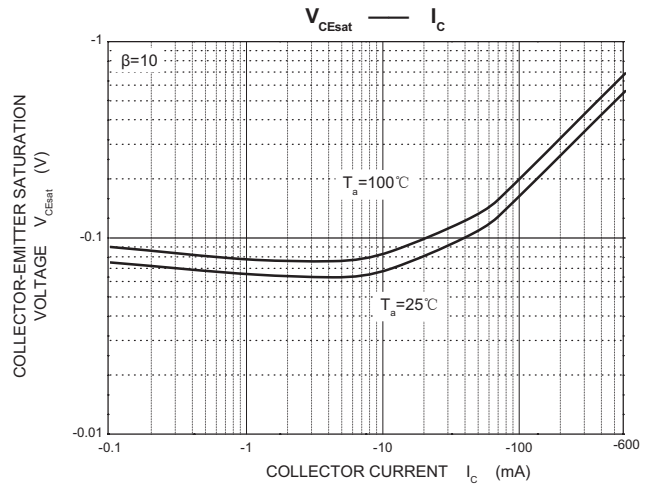
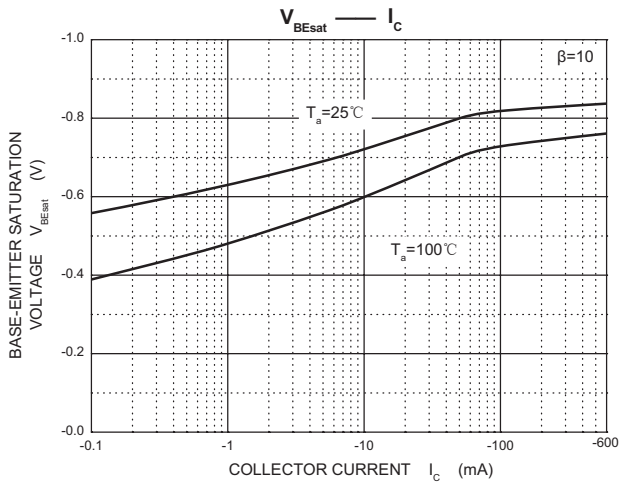
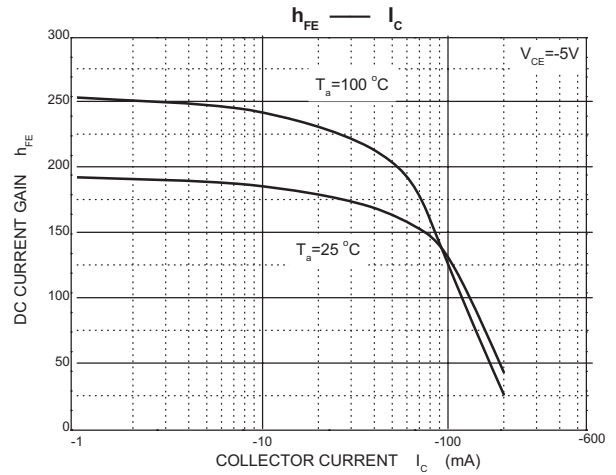
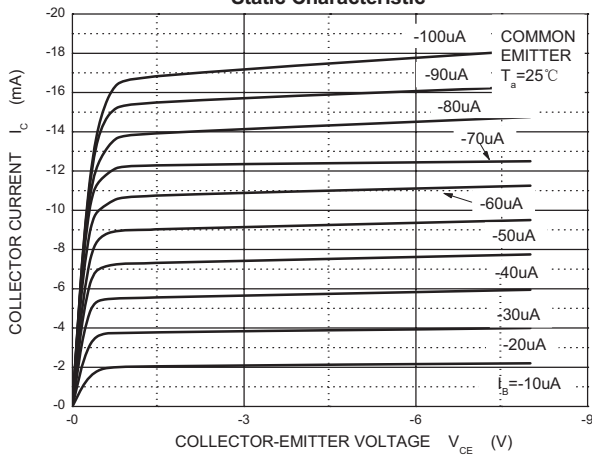

MMBT5401

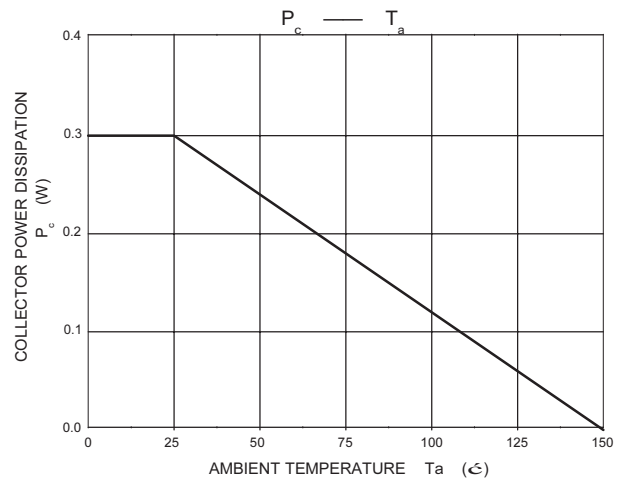
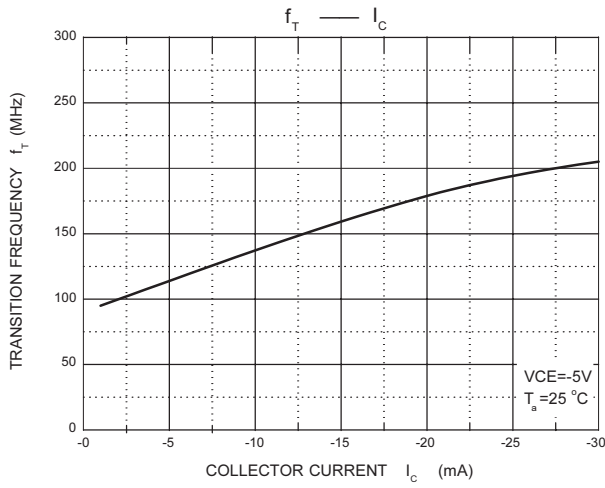



Micro Commercial Components

Ordering Information :

Device	Packing
Part Number-TP	Tape&Reel; 3Kpcs/Reel

Note : Adding "-HF" suffix for halogen free, eg. Part Number-TP-HF

IMPORTANT NOTICE

Micro Commercial Components Corp. reserves the right to make changes without further notice to any product herein to make corrections, modifications, enhancements, improvements, or other changes. **Micro Commercial Components Corp.** does not assume any liability arising out of the application or use of any product described herein; neither does it convey any license under its patent rights, nor the rights of others. The user of products in such applications shall assume all risks of such use and will agree to hold **Micro Commercial Components Corp.** and all the companies whose products are represented on our website, harmless against all damages.

LIFE SUPPORT

MCC's products are not authorized for use as critical components in life support devices or systems without the express written approval of Micro Commercial Components Corporation.

CUSTOMER AWARENESS

Counterfeiting of semiconductor parts is a growing problem in the industry. Micro Commercial Components (MCC) is taking strong measures to protect ourselves and our customers from the proliferation of counterfeit parts. MCC strongly encourages customers to purchase MCC parts either directly from MCC or from Authorized MCC Distributors who are listed by country on our web page cited below. Products customers buy either from MCC directly or from Authorized MCC Distributors are genuine parts, have full traceability, meet MCC's quality standards for handling and storage. **MCC will not provide any warranty coverage or other assistance for parts bought from Unauthorized Sources.** MCC is committed to combat this global problem and encourage our customers to do their part in stopping this practice by buying direct or from authorized distributors.

www.mccsemi.com



Компания «ЭлектроПласт» предлагает заключение долгосрочных отношений при поставках импортных электронных компонентов на взаимовыгодных условиях!

Наши преимущества:

- Оперативные поставки широкого спектра электронных компонентов отечественного и импортного производства напрямую от производителей и с крупнейших мировых складов;
- Поставка более 17-ти миллионов наименований электронных компонентов;
- Поставка сложных, дефицитных, либо снятых с производства позиций;
- Оперативные сроки поставки под заказ (от 5 рабочих дней);
- Экспресс доставка в любую точку России;
- Техническая поддержка проекта, помощь в подборе аналогов, поставка прототипов;
- Система менеджмента качества сертифицирована по Международному стандарту ISO 9001;
- Лицензия ФСБ на осуществление работ с использованием сведений, составляющих государственную тайну;
- Поставка специализированных компонентов (Xilinx, Altera, Analog Devices, Intersil, Interpoint, Microsemi, Aeroflex, Peregrine, Syfer, Eurofarad, Texas Instrument, Miteq, Cobham, E2V, MA-COM, Hittite, Mini-Circuits, General Dynamics и др.);

Помимо этого, одним из направлений компании «ЭлектроПласт» является направление «Источники питания». Мы предлагаем Вам помощь Конструкторского отдела:

- Подбор оптимального решения, техническое обоснование при выборе компонента;
- Подбор аналогов;
- Консультации по применению компонента;
- Поставка образцов и прототипов;
- Техническая поддержка проекта;
- Защита от снятия компонента с производства.



Как с нами связаться

Телефон: 8 (812) 309 58 32 (многоканальный)

Факс: 8 (812) 320-02-42

Электронная почта: org@eplast1.ru

Адрес: 198099, г. Санкт-Петербург, ул. Калинина, дом 2, корпус 4, литера А.